

# DATABOOK

## CMOS Integrated Circuits

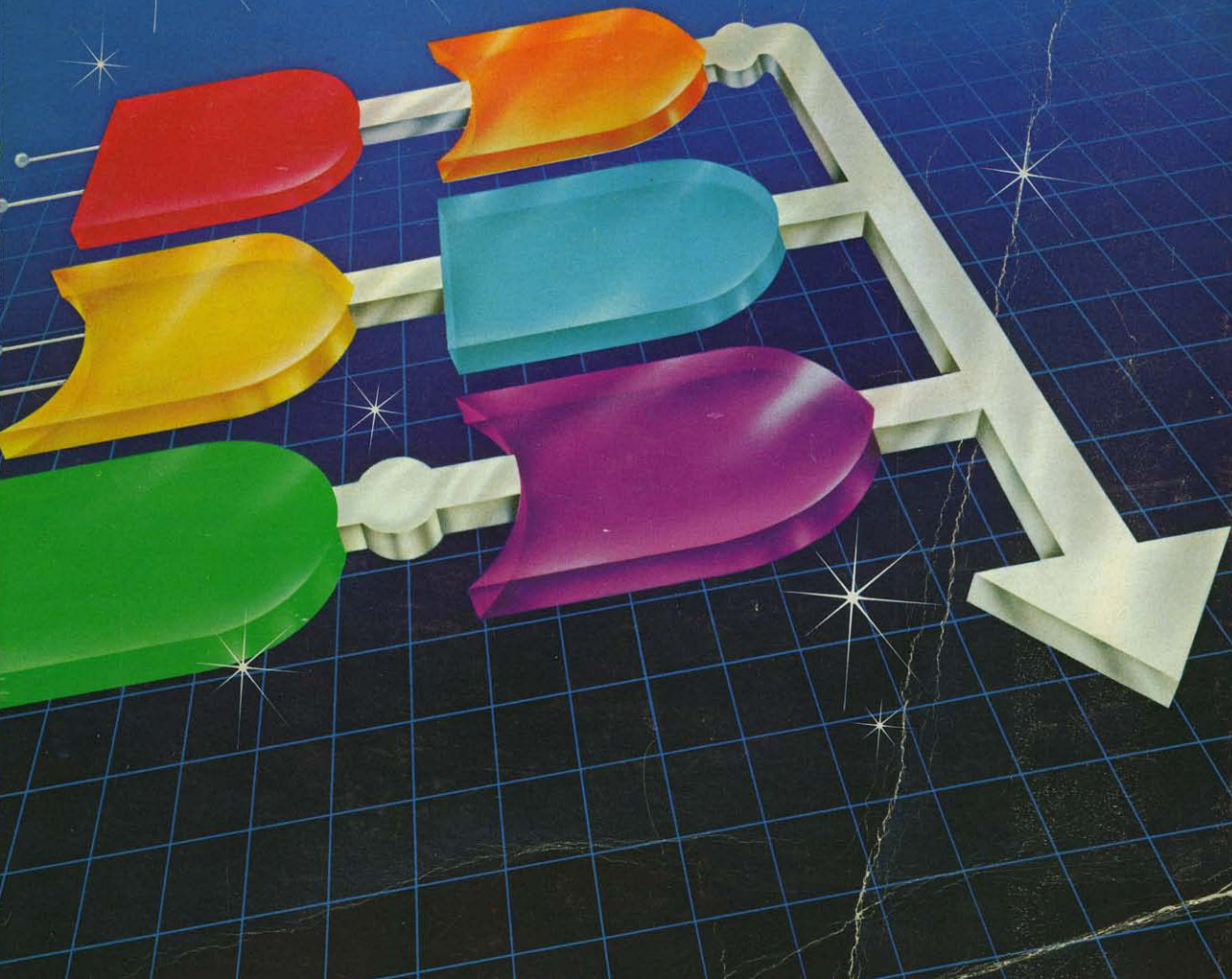



# RCA CMOS Integrated Circuits

## Table of Contents

This DATABOOK contains complete technical information on RCA standard commercial CMOS integrated circuits. It covers the full line of RCA standard A- and B-series digital logic circuits, and special-function circuits (telecommunications and special interface and display-driver circuits).

The DATABOOK is divided into eight major sections. The first section includes a complete index of types, classification and selection charts, functional diagrams, and photographs of available package options. This section is followed by a discussion of general considerations that should be taken into account in the operation and application of CMOS integrated circuits.

Three separate data sections provide definitive ratings and characteristics for (1) high-voltage B-series types, (2) A-series types, (3) special-function types.

Data pages for individual devices are included as nearly as possible in alphanumerical sequence of type numbers. Because some devices are grouped together to show similarity of function or data, individual type numbers may be out of sequence. If you don't find the type number you're looking for where you expect it to be, check the Index to Devices.

Next, a high-reliability CMOS IC's section describes the extensive line of RCA high-reliability integrated circuits that are processed and screened in accordance with military, RCA, or special custom specifications to meet the needs of modern military, aerospace, and critical industrial and scientific applications.

The DATABOOK also includes Dimensional Outlines, Application Notes, and RCA Sales Offices, Manufacturers' Representatives, and Authorized Distributors.

**General Guide to CMOS Integrated Circuits** 1

**General Operating and Application Considerations** 2

**CMOS High-Voltage B-Series Integrated Circuits—Technical Data** 3

**CMOS A-Series Integrated Circuits—Technical Data** 4

**CMOS Telecommunications, Display-Driver, and Interface Circuits—Technical Data** 5

**CMOS High-Reliability Integrated Circuits** 6

**Dimensional Outlines** 7

**Application Notes** 8

**RCA Sales Offices, Authorized Distributors, and Manufacturers' Representatives** 9



**Solid State**

Somerville, NJ • Brussels • Paris • London  
Hamburg • Sao Paulo • Hong Kong

---

Information furnished by RCA is believed to be accurate and reliable. However, no responsibility is assumed by RCA for its use; nor for any infringements of patents or other rights of third parties which may result from its use. No license is granted by implication or otherwise under any patent or patent rights of RCA.

The device data shown for some types are indicated as preliminary or objective. **Preliminary data** are intended for guidance purposes in evaluating devices for equipment design. Such data are shown for types currently being designed for inclusion in our standard line of commercially available products. **Objective data** are intended for engineering evaluation of types in the initial stages of design. The type designations and data are subject to change, unless otherwise arranged. No obligations are assumed for notice of change or future manufacture of these devices. For current information on the status of preliminary or objective programs, please contact your local RCA sales office.

Copyright 1983 by RCA Corporation  
(All rights reserved under Pan-American Copyright Convention)

Trademark(s) ® Registered  
Marca(s) Registrada(s)

Printed in USA 8-83

---

# General Guide to CMOS Integrated Circuits

	Page
Index to Devices .....	4
Index to Application Notes .....	5
Product Classification Chart .....	6
Function Selection Chart .....	7
Package and Ordering Information .....	14
Functional Diagrams .....	15
Industry-to-RCA Type Cross-Reference Guide .....	31

## Index to Devices

This index does not include package designation suffix letters for individual type numbers; the various packages available are shown in the data section.

Type No.	Page	Data Bulletin File No.	Type No.	Page	Data Bulletin File No.	Type No.	Page	Data Bulletin File No.	Type No.	Page	Data Bulletin File No.
CA3300	620	1316	CD4023UB	86	947	CD4050B	202	926	CD4527B	333	1006
CA3308	631	1352	CD4024A	525	930	CD4051B	206	902	CD4532B	338	876
CA3308A	631	1352	CD4024B	122	1063	CD4052B	206	902	CD4536B	342	1186
CD4000A	478	944	CD4025A	478	944	CD4053B	206	902	CD4538B	350	1245
CD4000B	58	985	CD4025B	58	985	CD4054B	213	634	CD4541B	356	1378
CD4000UB	62	945	CD4025UB	62	945	CD4055B	213	634	CD4543B	360	1327
CD4001A	478	944	CD4026A	528	918	CD4056B	213	634	CD4555B	366	858
CD4001B	58	985	CD4026B	126	1118	CD4057A	593	635	CD4556B	366	858
CD4001UB	62	945	CD4027A	532	941	CD4059A	601	898	CD4585B	371	1146
CD4002A	478	944	CD4027B	132	942	CD4060A	609	813	CD4724B	375	1111
CD4002B	58	985	CD4028A	535	937	CD4060B	218	1120	CD22100	636	1076
CD4002UB	62	945	CD4028B	136	1016	CD4062A	612	816	CD22101	641	1039
CD4006A	481	920	CD4029A	538	931	CD4063B	222	805	CD22102	641	1039
CD4006B	66	1033	CD4029B	140	1028	CD4066A	616	769	CD22103	649	1310
CD4007A	484	921	CD4030A	541	932	CD4066B	226	1114	CD22104	656	1259
CD4007UB	70	977	CD4030B	146	1055	CD4067B	231	909	CD22104A	656	1259
CD4008A	487	950	CD4031A	543	569	CD4068B	237	809	CD22105	661	1258
CD4008B	74	951	CD4031B	149	1073	CD4069UB	240	804	CD22105A	661	1258
CD4009A	489	939	CD4032A	546	915	CD4070B	243	910	CD22301	666	1368
CD4009UB	78	940	CD4032B	154	1081	CD4071B	246	807	CD22401	670	1388
CD4010A	489	939	CD4033A	528	918	CD4072B	246	807	CD22413	676	1279
CD4010B	78	940	CD4033B	126	1118	CD4073B	250	806	CD22414	676	1279
CD4011A	492	946	CD4034A	549	575	CD4075B	246	807	CD22859	683	1257
CD4011B	82	986	CD4034B	158	1062	CD4076B	254	903	CD40100B	379	980
CD4011UB	86	947	CD4035A	553	568	CD4077B	243	910	CD40101B	384	1000
CD4012A	492	946	CD4035B	164	1101	CD4078B	258	810	CD40102B	387	984
CD4012B	82	986	CD4037A	556	576	CD4081B	250	806	CD40103B	387	984
CD4012UB	86	947	CD4038A	546	915	CD4082B	250	806	CD40104B	394	1220
CD4013A	495	935	CD4038B	154	1081	CD4085B	261	811	CD40105B	401	1044
CD4013B	90	936	CD4040A	558	624	CD4086B	265	812	CD40106B	406	1017
CD4014A	498	922	CD4040B	122	1063	CD4089B	269	1003	CD40107B	410	1015
CD4014B	94	1043	CD4041A	561	572	CD4093B	274	836	CD40108B	413	1011
CD4015A	500	943	CD4041UB	169	934	CD4094B	278	869	CD40109B	418	1018
CD4015B	99	1024	CD4042A	565	589	CD4095B	282	879	CD40110B	422	1125
CD4016A	503	952	CD4042B	172	954	CD4096B	282	879	CD40115	687	1075
CD4016B	103	953	CD4043A	568	590	CD4097B	231	909	CD40116	689	1234
CD4017A	507	927	CD4043B	176	956	CD4098B	286	979	CD40117B	431	1333
CD4017B	108	1113	CD4044A	568	590	CD4099B	291	948	CD40147B	435	1117
CD4018A	511	929	CD4044B	176	956	CD4502B	295	1002	CD40160B	438	1047
CD4018B	113	1034	CD4045A	571	614	CD4503B	298	1224	CD40161B	438	1047
CD4019A	514	923	CD4045B	180	1119	CD4508B	301	1009	CD40162B	438	1047
CD4019B	118	1045	CD4046A	574	637	CD4510B	305	899	CD40163B	438	1047
CD4020A	516	928	CD4046B	184	1099	CD4511B	311	901	CD40174B	445	1031
CD4020B	122	1063	CD4047A	579	623	CD4512B	316	1032	CD40175B	449	1326
CD4021A	519	933	CD4047B	190	1123	CD4514B	319	814	CD40181B	455	989
CD4021B	94	1043	CD4048A	585	636	CD4515B	319	814	CD40182B	460	1008
CD4022A	522	919	CD4048B	197	1124	CD4516B	305	899	CD40192B	464	993
CD4022B	108	1113	CD4049A	590	599	CD4517B	323	1148	CD40193B	464	993
CD4023A	492	946	CD4049UB	202	926	CD4518B	328	808	CD40194B	394	1220
CD4023B	82	986	CD4050A	590	599	CD4520B	328	808	CD40208B	469	1007
									CD40257B	474	982

## Index to Application Notes

Number	Title	Page
ICAN-6080	"Digital-to-Analog Conversion Using the RCA-CD4007A COS/MOS IC" (Abstract)	786
ICAN-6086	"Timekeeping Advances Through COS/MOS Technology"	708
ICAN-6101	"The RCA COS/MOS Phase-Locked Loop—A Versatile Building Block for Micro-Power Digital and Analog Applications"	714
ICAN-6166	"COS/MOS MSI Counter and Register Design and Applications" (Abstract)	786
ICAN-6176	"Noise Immunity of COS/MOS Integrated-Circuit Logic Gates" (Abstract)	786
ICAN-6210	"A Typical Data-Gathering and Processing System Using CD4000A-Series COS/MOS Parts" (Abstract)	786
ICAN-6230	"Using the CD4047A in COS/MOS Timing Applications"	718
ICAN-6289	"A COS/MOS PCM Telemetry and Remote Data Acquisition Design" (Abstract)	786
ICAN-6315	"COS/MOS Interfacing Simplified"	725
ICAN-6346	"Applications of the RCA-CD4093B COS/MOS Schmitt Trigger"	728
ICAN-6362	"Using the CD4520B to Design Dividers with Symmetrical Outputs" (Abstract)	786
ICAN-6374	"The COS/MOS CD4059A Programmable Divide-by-N Counter in FM and Citizens-Band-Transceiver Tuners" (Abstract)	786
ICAN-6466	"Astable and Monostable Oscillators Using RCA COS/MOS Digital Integrated Circuits"	731
ICAN-6498	"Design of Fixed and Programmable Counters Using the RCA-CD4018A COS/MOS Presettable Divide-by-N Counter" (Abstract)	786
ICAN-6525	"Guide to Better Handling and Operation of CMOS Integrated Circuits"	737
ICAN-6532	"Fundamentals of Testing COS/MOS Integrated Circuits"	740
ICAN-6552	"A Basic Selection Guide to Digital Counters"	749
ICAN-6558	"Understanding Buffered and Unbuffered CMOS Characteristics"	752
ICAN-6563	"Radiation Resistance of the COS/MOS CD4000A and CD4000B Series"	757
ICAN-6564	"Application of CD40107BE COS/MOS Dual NAND Buffer"	759
ICAN-6572	"COS/MOS Electrostatic-Discharge Protection Networks"	762
ICAN-6576	"Power-Supply Considerations for COS/MOS Devices"	764
ICAN-6587	"Noise Immunity of COS/MOS B-Series Integrated Circuits"	767
ICAN-6595	"Interfacing Analog and Digital Displays with CMOS Integrated Circuits"	775
ICAN-6600	"Arithmetic Arrays Using Standard COS/MOS Building Blocks" (Abstract)	786
ICAN-6601	"Transmission and Multiplexing of Analog or Digital Signals Utilizing the CD4016A Quad Bilateral Switch" (Abstract)	786
ICAN-6602	"Interfacing COS/MOS with Other Logic Families" (Abstract)	786
ICAN-6716	"Low-Power Digital Frequency Synthesizers Utilizing COS/MOS IC's" (Abstract)	786
ICAN-6733	"Battery-Powered Digital-Display Clock/Timer and Metering Applications Utilizing the RCA-CD4026A and CD4033A Decade Counters—7-Segment Output Types" (Abstract)	786
ICAN-6739	"COS/MOS Rate Multipliers—Versatile Circuits for Synthesizing Digital Functions" (Abstract)	786
ICAN-6883	"Simplified Design of Astable RC Oscillators Using the CD4060B or two CMOS Inverters"	781
ICAN-6948	"Parallel Clocking of Sequential CMOS Devices"	782
ICAN-7037	"Logarithmic Units of Measure in Telecommunications"	783





## Function Selection Chart

Function	Type No.	No. of Pins	Function	Type No.	No. of Pins
<b>Gates</b>			<b>Gates (cont'd)</b>		
<b>NOR/NAND</b>			<b>Multifunction/AOI (cont'd)</b>		
Dual 4-input NOR	CD4002B	14	Quad AND/OR Select	CD4019B	16
	CD4002UB	14		CD4019A	16
	CD4002A	14	Dual 2-wide, 2-input AND/OR invert (AOI)	CD4085B	14
Dual 4-input NAND	CD4012B	14	Expandable 4-wide, 2-input AND/OR invert (AOI)	CD4086B	14
	CD4012UB	14	Multifunctional expandable 8-input (3-state output)	CD4048B	16
	CD4012A	14		CD4048A	16
Triple 3-input NOR	CD4025B	14			
	CD4025UB	14	<b>Decoders/Encoders</b>		
	CD4025A	14	BCD-to-decimal decoder	CD4028B	16
Triple 3-input NAND	CD4023B	14		CD4028A	16
	CD4023UB	14	8-input priority encoder	CD4532B	16
	CD4023A	14	10-line to 4-line BCD priority encoder	CD40147B	16
Quad 2-input NOR	CD4001B	14	4-bit latch/4-to-16 line decoder (outputs high)	CD4514B	24
	CD4001UB	14	4-bit latch/4-to-16 line decoder (outputs low)	CD4515B	24
	CD4001A	14	Dual 1-of-4 decoder/demultiplexer (outputs high)	CD4555B	16
Quad-2 input NAND	CD4011B	14	Dual 1-of-4 decoder/demultiplexer (outputs low)	CD4556B	16
	CD4011UB	14			
	CD4011A	14	<b>Schmitt Trigger</b>		
8-input NOR/OR	CD4078B	14	Quad 2-input NAND	CD4093B	14
8-input NAND/AND	CD4068B	14	Hex	CD40106B	14
Dual 3-input NOR plus inverter	CD4000B	14			
	CD4000UB	14	<b>Interface</b>		
	CD4000A	14	Quad low-to-high voltage	CD40109B	16
Dual 2-input NAND buffer/driver	CD40107B	8,14	Hex high-to-low voltage (inverting)	CD4009UB	16
				CD4009A	16
<b>OR/AND</b>				CD4049UB	16
Dual 4-input OR	CD4072B	14		CD4049A	16
Dual 4-input AND	CD4082B	14	Hex high-to-low voltage (non-inverting)	CD4010B	16
Triple 3-input OR	CD4075B	14		CD4010A	16
Triple 3-input AND	CD4073B	14	Dual 2-input NAND buffer/driver	CD4050B	16
Quad 2-input OR	CD4071B	14	8-bit bidirectional CMOS-to-TTL level converter	CD4050A	16
Quad 2-input AND	CD4081B	14	8-bit bidirectional CMOS-to-TTL level converter	CD40107B	8,14
<b>Buffers and Inverters</b>			Programmable dual 4-bit terminator	CD40117B <sup>∇</sup>	14
Dual complementary pair plus inverter	CD4007UB	14	<b>A/D Converters</b>		
	CD4007A	14	Video-speed 6-bit flash A/D converter	CA3300	18
Hex inverter	CD4069UB	14	Video-speed 8-bit flash A/D converter	CA3308	24
Hex inverter/buffer (3-state)	CD4502B	16			
Hex buffer (3-state non-inverting)	CD4503B	16	<b>Multivibrators</b>		
Hex buffer/converter (inverting)	CD4009UB	16	Monostable/astable	CD4047B	14
	CD4009A	16		CD4047A	14
Hex buffer/converter (inverting)	CD4049UB	16	Dual monostable	CD4098B	16
	CD4049A	16	Dual precision monostable	CD4538B	16
Hex buffer/converter (non-inverting)	CD4010B	16			
	CD4010A	16			
Hex buffer/converter (non-inverting)	CD4050B	16			
	CD4050A	16			
Quad true/complement buffer	CD4041UB	14			
	CD4041A	14			
Dual 2-input NAND buffer/driver	CD40107B	8,14			
<b>Multifunction/AOI</b>					
Triple AND-OR bi-phase pairs	CD4037A	14			
Quad exclusive-OR	CD4030B	14			
	CD4030A	14			
Quad exclusive-OR	CD4070B	14			
Quad exclusive-NOR	CD4077B	14			

<sup>∇</sup> Indicates types designed for special applications. Ratings and characteristics data for these types differ in some aspects from the standardized data for A- and B-series types. Refer to data pages on these types for specific differences.

## Function Selection Chart

Function	Type No.	No. of Pins	Function	Type No.	No. of Pins
<b>Multivibrators (cont'd)</b>			<b>Counters</b>		
<b>Flip-Flops</b>			<b>Binary Ripple</b>		
Dual "D" with set/reset capability	CD4013B	14	7-stage	CD4024B	14
	CD4013A	14		CD4024A	14
Dual "J-K" with set/reset capability	CD4027B	16	12-stage	CD4040B	16
	CD4027A	16		CD4040A	16
Gated "J-K" (non-inverting)	CD4095B	14	14-stage	CD4020B	16
Gated "J-K" (inverting and non-inverting)	CD4096B	14		CD4020A	16
Hex "D"	CD40174B	16	14-stage counter/divider and oscillator	CD4060B	16
4-bit "D" with 3-state outputs	CD4076B	14		CD4060A	16
Quad "D"	CD40175B	16	<b>Timers</b>		
<b>Latches</b>			21-stage	CD4045B	14
Quad clocked "D"	CD4042B	16		CD4045A	14
	CD4042A	16	Programmable	CD4536B	16
Quad NOR R/S (3-state outputs)	CD4043B	16		CD4541B	14
	CD4043A	16	<b>Synchronous</b>		
Quad NAND R/S (3-state outputs)	CD4044B	16	Decade counter/divider plus 10 decoded decimal outputs	CD4017B	16
	CD4044A	16		CD4017A	16
Dual 4-bit	CD4508B	24	Divide-by-8 counter/divider with 8 decimal outputs	CD4022B	16
8-bit addressable	CD4099B	16		CD4022A	16
	CD4724B	16	Presetable divide-by-"N" counter, fixed or programmable	CD4018B	16
<b>Registers</b>				CD4018A	16
<b>Shift Registers-Static</b>			Programmable-divide-by-"N" counter	CD4059A	24
Dual 4-stage with serial input/parallel output	CD4015B	16	Presetable up/down counter, binary or BCD-decade	CD4029B	16
	CD4015A	16		CD4029A	16
18-stage	CD4006B	14	Presetable 4-bit BCD up/down counter	CD4510B	16
	CD4006A	14	Presetable 4-bit binary up/down counter	CD4516B	16
64-stage	CD4031B	16	Presetable 2-decade BCD down counter	CD40102B	16
	CD4031A	16	Presetable 8-bit binary down counter	CD40103B	16
Dual 64-bit	CD4517B	16	Presetable 4-bit BCD up/down counter	CD40192B	16
8-stage with synchronous parallel or serial input/serial output	CD4014B	16		CD40193B	16
	CD4014A	16	Dual BCD up counter	CD4518B	16
8-stage with asynchronous parallel input or synchronous serial input/serial output	CD4021B	16	Dual binary up counter	CD4520B	16
	CD4021A	16	Decade counter/asynchronous clear	CD40160B	16
4-stage parallel-in/parallel-out with J-K input and true/complement output	CD4035B	16	Binary counter/asynchronous clear	CD40161B	16
	CD4035A	16	Decade counter/synchronous clear	CD40162B	16
4-bit universal bidirectional with 3-state outputs	CD40104B	16	Binary counter/synchronous clear	CD40163B	16
4-bit universal bidirectional with asynchronous master reset	CD40194B	16	<b>Display Drivers</b>		
8-stage bidirectional parallel or serial input/parallel output	CD4034B	24	<b>With Counter</b>		
	CD4034A	24	Decade counter/divider with 7-segment display outputs and display enable	CD4026B	16
32-bit left/right	CD40100B	16		CD4026A	16
8-stage shift-and-store bus	CD4094B	16	Decade counter/divider with 7-segment display outputs and ripple blanking	CD4033B	16
	CD4062A	12		CD4033A	16
<b>Shift Registers-Dynamic</b>			Up/Down Counter-Latch-Decoder-Driver	CD40110B	16
200-stage	CD4062A	12			
<b>Storage Registers</b>					
8-bit addressable latch	CD4099B	16			
	CD4724B	16			
4-bit "D"-type with 3-state outputs	CD4076B	16			
4 X 4 Multiport	CD40108B	24			
4 X 4 Multiport	CD40208B	24			
<b>FIFO Buffer Registers</b>					
4-bit X 16 word	CD40105B	16			

## Function Selection Chart

Function	Type No.	No. of Pins	Function	Type No.	No. of Pins
<b>Display Drivers (cont'd)</b>			<b>Arithmetic Circuits (Cont'd)</b>		
<b>For Liquid-Crystal-Display Drive</b>			<b>Adders/Comparators</b>		
4-segment display driver	CD4054B	16	Quad exclusive-OR gate	CD4030B	14
BCD-to-7-segment decoder/driver with "display-frequency" output	CD4055B	16	Quad exclusive-OR gate	CD4030A	14
BCD-to-7-segment decoder/driver with strobed-latch function	CD4056B	16	Quad exclusive-NOR gate	CD4070B	14
	CD4543B	16		CD4077B	14
4-digit decoder/driver with hexadecimal display	CD22104▽	40	<b>ALU/Rate Multipliers</b>		
4-digit decoder/driver with decimal display	CD22104A ▽	40	4-bit arithmetic logic unit	CD40181B	24
4-digit decoder/driver with hexadecimal display	CD22105 ▽	40		CD4057A	28
4-digit decoder/driver with decimal display	CD22105A ▽	40	BCD rate multiplier	CD4527B	16
			Binary rate multiplier	CD4089B	16
			Look-ahead-carry block	CD40182B	16
<b>For Light-Emitting-Diode Drive</b>			<b>Parity Generator/Checker</b>		
BCD-to-7-segment latch decoder/driver	CD4511B	16	9-bit	CD40101B	14
<b>Multiplexers/Demultiplexers</b>			<b>Multiport Register</b>		
<b>Analog</b>			4 X 4	CD40108B	24
Triple 2-channel	CD4053B	16	4 X 4	CD40208B	24
Differential 4-channel	CD4052B	16	8 X 1	CD4034B	24
Single 8-channel	CD4051B	16	8 X 1	CD4034A	24
Differential 8-channel	CD4097B	24	<b>Quad Bilateral Switches</b>		
Single 16-channel	CD4067B	24			
Quad bilateral switch	CD4016B	14	For transmission or multiplexing of analog or digital signals	CD4016B	14
	CD4016A	14		CD4016A	14
Quad bilateral switch	CD4066B	14		CD4066B	14
	CD4066A	14	<b>Telecommunication Circuits</b>		
<b>Digital (Data Selectors)</b>			<b>Crosspoint Switches</b>		
Quad AND/OR select	CD4019B	16	4 X 4 crosspoint switch with control memory	CD22100 ▽	16
	CD4019A	16	4 X 4 X 2 crosspoint switch with control memory	CD22101 ▽	24
Dual 1-of-4 decoder/demultiplexer (outputs high)	CD4555B	16	4 X 4 X 2 crosspoint switch with control memory	CD22102 ▽	24
Dual 1-of-4 decoder/demultiplexer (outputs low)	CD4556B	16	<b>HDB3 Transcoder</b>		
Quad 2-line-to-1-line 8-channel	CD40257B	16	HDB3 transcoder for 2.048/8.448 Mb/s transmission applications	CD22103 ▽	16
	CD4512B	16	<b>PCM Line Repeater</b>		
<b>Phase-Locked Loop</b>			PCM line repeater	CD22301 ▽	18
Micropower	CD4046B	16	<b>Timer/Driver</b>		
	CD4046A	16	16-channel precision timer/driver	CD22401 ▽	40
<b>Arithmetic Circuits</b>			<b>PCM Data Filters</b>		
<b>Adders/Comparators</b>			Pulse code modulation sampled-data filters		
4-bit full adder with parallel carry out	CD4008B	16		CD22413 ▽	16
	CD4008A	16		CD22414 ▽	16
Triple serial adder, positive logic	CD4032B	16	<b>Tone Generator</b>		
	CD4032A	16	Dual-tone multifrequency tone generator	CD22859 ▽	16
Triple serial adder, negative logic	CD4038B	16			
	CD4038A	16			
4-bit magnitude comparator	CD4063B	16			
	CD4585B	16			

▽ Indicates types designed for special applications. Ratings and characteristics data for these types differ in some aspects from the standardized data for A- and B-series types. Refer to data pages on these types for specific differences.

## CMOS LSI Products

In addition to the logic and special-function integrated circuits listed in the preceding pages, RCA offers an all-CMOS line of microprocessor, memory and peripheral integrated circuits.

The RCA CDP1800 series offers the most complete line of CMOS microprocessor and associated memory and peripheral devices in the industry. In addition to microprocessors and microcomputers, this product line includes a hardware multiply/divide unit (MDU), a programmable I/O, video and keyboard interface circuits, latches and decoders, a universal asynchronous receiver-transmitter (UART), buffers, separators, and a broad complement of directly interfaceable random-access memories (RAM's) and read-only memories (ROM's).

RCA also offers the CDP6800 family, a new series of pin-for-pin replacements for the MC146805 Series of CMOS microprocessors and peripherals primarily intended for single-chip system applications.

In addition to the memories designed to interface directly with CDP1800-series microprocessors, RCA also offers a line of general-purpose memories.

For descriptive information on RCA microprocessor and memory circuits, refer to the RCA "CMOS-LSI" DATABOOK, SSD-260A.

For the designers of microprocessor-based equipment and in support of the CDP1800-series microprocessors and associated memory and peripheral circuits, RCA provides a strong and extensive line of systems, system support components, system support software, system modules (including Microboard milliwatt computer systems), and other development aids.

The RCA Microsystems DATABOOK SSD-270 provides detailed information on RCA Microprocessor-based development systems and Microboard computer modules.

## CMOS LSI Products

Part No.	Description	No. of Pins	Part No.	Description	No. of Pins
<b>Microprocessors</b>			<b>ROMs</b>		
CDP1802A	8-Bit	40	CDM5332	Mask-programmable ROM 512 x 8	24
CDP1802B	8-Bit	40	CDM5333	Mask-programmable ROM 512 x 8	24
CDP1805C	8-Bit with RAM	40	CDM53128	Mask-programmable ROM 16K x 8	28
CDP1805AC	8-Bit with RAM	40	CDM53256	Mask-programmable ROM 32K x 8	28
CDP1806C	8-Bit with Counter-Timer	40	CDP1831	Mask-programmable ROM 512 x 8	24
CDP1806AC	8-Bit with Counter-Timer	40	CDP1832	Mask-programmable ROM 512 x 8	24
CDP6805E2	8-Bit with RAM/I-O/Counter-Timer	40	CDP1833	Mask-programmable ROM 1K x 8	24
<b>Microcomputers</b>			CDP1833B	Mask-programmable ROM 1K x 8	24
CDP1804A	8-Bit with RAM/ROM/Counter-Timer	40	CDP1834	Mask-programmable ROM 1K x 8	24
CDP6805F2	8-Bit with RAM/ROM/I-O/Counter-Timer	28	CDP1835	Mask-programmable ROM 2K x 8	24
CDP6805G2	8-Bit with RAM/ROM/I-O/Counter-Timer	40	CDP1837	Mask-programmable ROM 4K x 8	24
<b>RAMs</b>			CDP65516	Mask-programmable ROM 2K x 8	18
CDP1821	1K x 1	16	<b>Input/Output Circuits</b>		
CDP1822	256 x 4	22	CDP1851	Programmable I/O (PIO)	40
CDP1823	128 x 8	24	CDP1852	Byte I/O - 8-Bit I/O Port	24
CDP1824	32 x 8	18	CDP1853	Decoder - 1 of 8	16
CDP1826	64 x 8	22	CDP1855	Multiply/Divide Unit (MDU)	28
CDM6116	2K x 8	24	CDP1856	Buffer - 4-Bit	16
CDM6117	2K x 8	24	CDP1857	Buffer - 4-Bit	16
CDM6118	2K x 8	24	CDP1858	Latch/Decoder - 4-Bit	16
MWS5101	256 x 4	22	CDP1859	Latch/Decoder - 4-Bit	16
MWS5101A	256 x 4	22			
MWS5114	1K x 4	18			
CD4036A	4 x 8	24			
CD4039A	4 x 8	24			
CD4061A	256 x 1	16			
CD40061A	256 x 1	16			
CD40114B	16 x 4	16			

## CMOS LSI Products (Cont'd)

Part No.	Description	No. of Pins	Part No.	Description	No. of Pins
CDP1861	Video Display Controller (VDC)	24	CDP1874	High-Speed Input Port - 8-Bit	22
CDP1862	Color Generator Circuit	24	CDP1875	High-Speed Output Port	22
CDP1863	Programmable Frequency Generator	16	CDP1876	Video Interface System (VIS)	40
CDP1864	PAL Video Display Controller (VDC)	40	CDP1877	Programmable Interrupt Controller	28
CDP1866	Latch/Decoder - 4-Bit	18	CDP1878	Dual Counter-Timer	28
CDP1867	Latch/Decoder - 4-Bit	18	CDP1879	Real Time Clock	24
CDP1868	Latch/Decoder - 4-Bit	18	CDP1881	Latch/Decoder - 4-Bit	20
CDP1869	Video Interface System (VIS)	40	CDP1882	Latch/Decoder - 4-Bit	18
CDP1870	Video Interface System (VIS)	40	CDP6818	Real Time Clock with RAM	24
CDP1871A	Keyboard Encoder, ASCII/Hex	40	CDP6823	Parallel Interface	40
CDP1872	High-Speed Input Port - 8-Bit	22	<b>UARTs</b>		
CDP1873	High-Speed Decoder - 1 of 8	16	CDP1854A	UART	40
			CDP6402	Industry Standard UART	40

## The QMOS Product Line

RCA also offers the QMOS series of high-speed CMOS logic integrated circuits which include an extensive line of products that are pin compatible with many existing bipolar 54/74LSTTL and CMOS 4000 series of digital logic types. The new QMOS IC's provide high-speed CMOS replacements for the most popular LSTTL devices in existing designs and also offer low-power all-CMOS designs for new digital systems. Key family features of the RCA QMOS types include:

- High Noise Immunity for Optimum All-CMOS-System Compatibility — CD74/54HC Family  
 $N_{IL} = 20\%$  of Supply,  $N_{IH} = 30\%$  of Supply

- Direct LSTTL Input Logic Level Compatibility as well as CMOS Input Compatibility — CD74/54HCT Family  
 (Can replace LSTTL or be mixed with LSTTL IC's.)  
 $V_{IL} = 0.8\text{ V max.}$ ,  $V_{IH} = 2\text{ V min.}$
- 2 to 6 V Operation — CD74/54HC Family
- 4.5 to 5.5 V — CD74/54HCT Family
- Gate Propagation Delay of 8 ns typ.,  $C_L = 15\text{ pF}$
- Balanced High-to-Low and Low-to-High Propagation Delays
- Significant Power Reduction Compared to LSTTL Bipolar Logic IC's
- Alternate Sourced

For descriptive information on the RCA QMOS series, refer to the RCA DATABOOK "QMOS High-Speed CMOS Logic", SSD-290.

## QMOS Products

CMOS Logic		TTL Logic		Pins	Description
Plastic Pkg.	CERDIP	Plastic Pkg.	CERDIP		
CD74HC00E	CD54HC00F	CD74HCT00E	CD54HCT00F	14	Quad 2-Input NAND Gate
CD74HC02E	CD54HC02F	CD74HCT02E	CD54HCT02F	14	Quad 2-Input NOR Gate
CD74HC04E	CD54HC04F	CD74HCT04E	CD54HCT04F	14	Hex Inverter/Buffer
CD74HC08E	CD54HC08F	CD74HCT08E	CD54HCT08F	14	Quad 2-Input AND Gate
CD74HC10E	CD54HC10F	CD74HCT10E	CD54HCT10F	14	Triple 3-Input NAND Gate
CD74HC11E	CD54HC11F	CD74HCT11E	CD54HCT11F	14	Triple 3-Input AND Gate
CD74HC14E	CD54HC14F	CD74HCT14E	CD54HCT14F	14	Hex Schmitt Trigger Inverter
CD74HC20E	CD54HC20F	CD74HCT20E	CD54HCT20F	14	Dual 4-Input NAND Gate
CD74HC27E	CD54HC27F	CD74HCT27E	CD54HCT27F	14	Triple 3-Input NOR Gate
CD74HC30E	CD54HC30F	CD74HCT30E	CD54HCT30F	14	8-Input NAND Gate
CD74HC32E	CD54HC32F	CD74HCT32E	CD54HCT32F	14	Quad 2-Input OR Gate
CD74HC42E	CD54HC42F	CD74HCT42E	CD54HCT42F	14	BCD-to-Decimal Decoder
CD74HC73E	CD54HC73F	CD74HCT73E	CD54HCT73F	14	Dual J-K Flip-Flop w/CLEAR
CD74HC74E	CD54HC74F	CD74HCT74E	CD54HCT74F	14	Dual D Flip-Flop w/PRESET and CLEAR
CD74HC75E	CD54HC75F	CD74HCT75E	CD54HCT75F	16	4-Bit Bistable Latch
CD74HC85E	CD54HC85F	CD74HCT85E	CD54HCT85F	16	4-Bit Magnitude Comparator
CD74HC86E	CD54HC86F	CD74HCT86E	CD54HCT86F	14	Quad 2-Input Excl. OR Gate
CD74HC107E	CD54HC107F	CD74HCT107E	CD54HCT107F	14	Dual J-K Flip-Flop w/CLEAR
CD74HC109E	CD54HC109F	CD74HCT109E	CD54HCT109F	14	Dual J-K Flip-Flop w/PRESET and CLEAR
CD74HC112E	CD54HC112F	CD74HCT112E	CD54HCT112F	16	Dual J-K Flip-Flop w/PRESET and CLEAR
CD74HC123E	CD54HC123F	CD74HCT123E	CD54HCT123F	16	Dual Retriggerable Monostable Multivibrator
CD74HC132E	CD54HC132F	CD74HCT132E	CD54HCT132F	14	Quad 2-Input NAND Schmitt Trigger
CD74HC138E	CD54HC138F	CD74HCT138E	CD54HCT138F	16	3-to-8 Line Decoder
CD74HC139E	CD54HC139F	CD74HCT139E	CD54HCT139F	16	Dual 1-of-4 Line Decoder
CD74HC147E	CD54HC147F	CD74HCT147E	CD54HCT147F	16	10-to-4 Line-Priority Encoder
CD74HC151E	CD54HC151F	CD74HCT151E	CD54HCT151F	16	8-Channel Digital Multiplexer
CD74HC153E	CD54HC153F	CD74HCT153E	CD54HCT153F	16	Dual 4-Input Multiplexer
CD74HC154E	CD54HC154F	CD74HCT154E	CD54HCT154F	24	4-to-16-Line Decoder
CD74HC157E	CD54HC157F	CD74HCT157E	CD54HCT157F	16	Quad 2-Input Multiplexer
CD74HC158E	CD54HC158F	CD74HCT158E	CD54HCT158F	16	Quad 2-Input Multiplexer, Inverting
CD74HC160E	CD54HC160F	CD74HCT160E	CD54HCT160F	16	BCD Decade Counter, Asynchronous Reset
CD74HC161E	CD54HC161F	CD74HCT161E	CD54HCT161F	16	4-Bit Binary Counter, Asynchronous Reset
CD74HC162E	CD54HC162F	CD74HCT162E	CD54HCT162F	16	BCD Decade Counter, Synchronous Reset
CD74HC163E	CD54HC163F	CD74HCT163E	CD54HCT163F	16	4-Bit Binary Counter, Synchronous Reset
CD74HC164E	CD54HC164F	CD74HCT164E	CD54HCT164F	14	8-Bit Serial-to-Parallel Shift Register
CD74HC165E	CD54HC165F	CD74HCT165E	CD54HCT165F	16	8-Bit Parallel-to-Serial Shift Register
CD74HC166E	CD54HC166F	CD74HCT166E	CD54HCT166F	16	8-Bit Serial/Parallel In, Serial Out Shift Register
CD74HC173E	CD54HC173F	CD74HCT173E	CD54HCT173F	16	Quad D Flip-Flop, 3-State
CD74HC174E	CD54HC174F	CD74HCT174E	CD54HCT174F	16	Hex D Flip-Flop w/CLEAR
CD74HC175E	CD54HC175F	CD74HCT175E	CD54HCT175F	16	Quad D Flip-Flop w/CLEAR
CD74HC190E	CD54HC190F	CD74HCT190E	CD54HCT190F	16	Async. Presettable BCD/Decade Up/Down Counter
CD74HC191E	CD54HC191F	CD74HCT191E	CD54HCT191F	16	Presettable Sync. 4-Bit Binary Up/Down Counter
CD74HC192E	CD54HC192F	CD74HCT192E	CD54HCT192F	16	Synchronous Decade Up/Down Counter
CD74HC193E	CD54HC193F	CD74HCT193E	CD54HCT193F	16	Synchronous Binary Up/Down Counter
CD74HC194E	CD54HC194F	CD74HCT194E	CD54HCT194F	16	4-Bit Bidirectional Universal Shift Register

## The QMOS Product Line (Cont'd)

CMOS Logic		TTL Logic		Pins	Description
Plastic Pkg.	CERDIP	Plastic Pkg.	CERDIP		
CD74HC195E	CD54HC195F	CD74HCT195E	CD54HCT195F	16	4-Bit Parallel Shift Register
CD74HC221E	CD54HC221F	CD74HCT221E	CD54HCT221F	16	Dual Monostable Multivibrator
CD74HC238E	CD54HC238F	CD74HCT238E	CD54HCT238F	16	1-of-8 Decoder
CD74HC240E	CD54HC240F	CD74HCT240E	CD54HCT240F	20	Octal Buffer Line Driver, 3-State, Inverting
CD74HC241E	CD54HC241F	CD74HCT241E	CD54HCT241F	20	Octal Buffer Line Driver, 3-State
CD74HC242E	CD54HC242F	CD74HCT242E	CD54HCT242F	14	Quad-Bus Transceiver, 3-State, Inverting
CD74HC243E	CD54HC243F	CD74HCT243E	CD54HCT243F	14	Quad-Bus Transceiver, 3-State
CD74HC244E	CD54HC244F	CD74HCT244E	CD54HCT244F	20	Octal-Buffer Line Driver, 3-State
CD74HC245E	CD54HC245F	CD74HCT245E	CD54HCT245F	20	Octal-Bus Transceiver, 3-State
CD74HC251E	CD54HC251F	CD74HCT251E	CD54HCT251F	16	8-Channel Multiplexer, 3-State
CD74HC253E	CD54HC253F	CD74HCT253E	CD54HCT253F	16	Dual 4-Input Multiplexer, 3-State
CD74HC257E	CD54HC257F	CD74HCT257E	CD54HCT257F	16	Quad 2-Input Multiplexer, 3-State
CD74HC259E	CD54HC259F	CD74HCT259E	CD54HCT259F	16	8-Bit Addressable Latch
CD74HC266E	CD54HC266F	CD74HCT266E	CD54HCT266F	14	Quad 2-Input Excl. NOR
CD74HC273E	CD54HC273F	CD74HCT273E	CD54HCT273F	20	Octal D Flip-Flop w/CLEAR
CD74HC280E	CD54HC280F	CD74HCT280E	CD54HCT280F	14	8-Bit Odd/Even Parity Generator/Checker
CD74HC297E	CD54HC297F	CD74HCT297E	CD54HCT297F	16	Digital Phase-Locked Loop Filter
CD74HC299E	CD54HC299F	CD74HCT299E	CD54HCT299F	20	8-Bit Universal Shift Register
CD74HC354E	CD54HC354F	CD74HCT354E	CD54HCT354F	20	8-Input Multiplexer, Latched-Data, 3-State
CD74HC356E	CD54HC356F	CD74HCT356E	CD54HCT356F	20	8-Input Multiplexer, Clocked-Latched-Data, 3-State
CD74HC365E	CD54HC365F	CD74HCT365E	CD54HCT365F	16	Hex 3-State Buffer
CD74HC366E	CD54HC366F	CD74HCT366E	CD54HCT366F	16	Hex 3-State Buffer, Inverting
CD74HC367E	CD54HC367F	CD74HCT367E	CD54HCT367F	16	Hex 3-State Buffer
CD74HC368E	CD54HC368F	CD74HCT368E	CD54HCT368F	16	Hex 3-State Buffer, Inverting
CD74HC373E	CD54HC373F	CD74HCT373E	CD54HCT373F	20	Octal Transparent Latch 3-State
CD74HC374E	CD54HC374F	CD74HCT374E	CD54HCT374F	20	Octal D Flip-Flop, 3-State
CD74HC377E	CD54HC377F	CD74HCT377E	CD54HCT377F	20	Octal D-Type Flip-Flop with Data Enable
CD74HC384E	CD54HC384F	CD74HCT384E	CD54HCT384F	16	8-Bit Serial Multiplier
CD74HC390E	CD54HC390F	CD74HCT390E	CD54HCT390F	16	Dual Decade Counter
CD74HC393E	CD54HC393F	CD74HCT393E	CD54HCT393F	16	Dual 4-Bit Binary Counter
CD74HC423E	CD54HC423F	CD74HCT423E	CD54HCT423F	16	Dual Retriggerable Monostable Multivibrator
CD74HC533E	CD54HC533F	CD74HCT533E	CD54HCT533F	20	Octal Transparent Latch, 3-State, Inverting
CD74HC534E	CD54HC534F	CD74HCT534E	CD54HCT534F	20	Octal D Flip-Flop, 3-State, Inverting
CD74HC540E	CD54HC540F	CD74HCT540E	CD54HCT540F	20	Octal Buffer Line Driver, 3-State, Inverting
CD74HC541E	CD54HC541F	CD74HCT541E	CD54HCT541F	20	Octal Buffer Line Driver, 3-State
CD74HC563E	CD54HC563F	CD74HCT563E	CD54HCT563F	20	Octal Transparent Latch, 3-State, Inverting
CD74HC564E	CD54HC564F	CD74HCT564E	CD54HCT564F	20	Octal D Flip-Flop, 3-State, Inverting
CD74HC573E	CD54HC573F	CD74HCT573E	CD54HCT573F	20	Octal Transparent Latch, 3-State
CD74HC574E	CD54HC574F	CD74HCT574E	CD54HCT574F	20	Octal D Flip-Flop, 3-State
CD74HC640E	CD54HC640F	CD74HCT640E	CD54HCT640F	20	Octal Bus Transceiver, 3-State, Inverting
CD74HC643E	CD54HC643F	CD74HCT643E	CD54HCT643F	20	Octal Bus Transceiver, 3-State
CD74HC646E	CD54HC646F	CD74HCT646E	CD54HCT646F	20	Octal Bus Transceiver, 3-State
CD74HC648E	CD54HC648F	CD74HCT648E	CD54HCT648F	20	Octal Bus Transceiver, 3-State, Inverting
CD74HC670E	CD54HC670F	CD74HCT670E	CD54HCT670F	16	4 x 4 Register File, 3-State
CD74HC688E	CD54HC688F	CD74HCT688E	CD54HCT688F	20	8-Bit Equality Comparator
CD74HC4002E	CD54HC4002F	CD74HCT4002E	CD54HCT4002F	14	Dual 4-Input NOR Gate
CD74HC4015E	CD54HC4015F	CD74HCT4015E	CD54HCT4015F	16	Dual 4-Stage Serial In/Parallel Out Shift Register
CD74HC4016E	CD54HC4016F	CD74HCT4016E	CD54HCT4016F	14	Quad Bilateral Switch
CD74HC4017E	CD54HC4017F	CD74HCT4017E	CD54HCT4017F	16	Decade Counter/Divider
CD74HC4020E	CD54HC4020F	CD74HCT4020E	CD54HCT4020F	16	14-Bit Binary Counter
CD74HC4024E	CD54HC4024F	CD74HCT4024E	CD54HCT4024F	14	7-Stage Binary Counter
CD74HC4040E	CD54HC4040F	CD74HCT4040E	CD54HCT4040F	16	12-Bit Binary Counter
CD74HC4046E	CD54HC4046F	CD74HCT4046E	CD54HCT4046F	16	Phase-Locked Loop
CD74HC4049E	CD54HC4049F	—	—	16	Hex Buffer, Inverting
CD74HC4050E	CD54HC4050F	—	—	16	Hex Buffer
CD74HC4051E	CD54HC4051F	CD74HCT4051E	CD54HCT4051F	16	8-Channel Analog MUX/DEMUX
CD74HC4052E	CD54HC4052F	CD74HCT4052E	CD54HCT4052F	16	Dual 4-Channel Analog MUX/DEMUX
CD74HC4053E	CD54HC4053F	CD74HCT4053E	CD54HCT4053F	16	Triple 2-Channel Analog MUX/DEMUX
CD74HC4060E	CD54HC4060F	CD74HCT4060E	CD54HCT4060F	16	14-Stage Binary Counter w/Oscillator
CD74HC4066E	CD54HC4066F	CD74HCT4066E	CD54HCT4066F	14	Quad Bilateral Switch
CD74HC4067E	CD54HC4067F	CD74HCT4067E	CD54HCT4067F	24	16-Channel Analog Multiplexer/Demultiplexer
CD74HC4075E	CD54HC4075F	CD74HCT4075E	CD54HCT4075F	14	Triple 3-Input OR Gate
CD74HC4094E	CD54HC4094F	CD74HCT4094E	CD54HCT4094F	16	8-Stage Shift-and-Store Bus Register
CD74HC4511E	CD54HC4511F	CD74HCT4511E	CD54HCT4511F	18	BCD-to-7-Segment Latch/Decoder/Driver
CD74HC4514E	CD54HC4514F	CD74HCT4514E	CD54HCT4514F	24	4-to-16-Line Decoder w/Latch
CD74HC4518E	CD54HC4518F	CD74HCT4518E	CD54HCT4518F	16	Dual BCD Up Counter
CD74HC4520E	CD54HC4520F	CD74HCT4520E	CD54HCT4520F	16	Dual Binary Up Counter
CD74HC4538E	CD54HC4538F	CD74HCT4538E	CD54HCT4538F	14	Dual Retriggerable Precision Monostable Multivibrator
CD74HC40102E	CD54HC40102F	CD74HCT40102E	CD54HCT40102F	16	Dual Decade BCD Down Counter
CD74HC40103E	CD54HC40103F	CD74HCT40103E	CD54HCT40103F	16	8-Bit Binary Down Counter
CD74HC40104E	CD54HC40104F	CD74HCT40104E	CD54HCT40104F	16	4-Bit Bidirectional Universal Shift Register, 3-State
CD74HC40105E	CD54HC40105F	CD74HCT40105E	CD54HCT40105F	16	FIFO Shift Register

Note: Add package suffix code to part number on all orders.  
 E=Dual-In-Line Plastic Package—Temp. Range=−40° C to +85° C.  
 F=Dual-In-Line Frit-Seal Ceramic Package (CERDIP)—Temp. Range=−55° C to +125° C.

# CMOS IC Packages

**D Suffix**  
Ceramic Dual-In-Line Packages



Welded-Seal 14,16,24,  
and 28-lead Versions

18, 22, 24, 40-Lead  
Side-Brazed Versions

**E Suffix**  
Plastic Dual-In-Line Packages



8,14,16,18,22,24, and 40-lead Versions

MiniDIP

**F Suffix**  
Frit-Seal Ceramic Dual-In-Line Packages

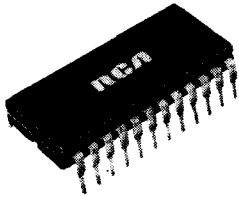

14,16, and 24-lead Versions

**K Suffix**  
Ceramic Flat Packages

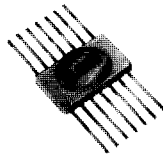

14, 16, and 24-lead Versions

**T Suffix**  
12-Lead TO-5 Style Package



CD4024A and CD4062A only

## Ordering Information

Most RCA CMOS integrated circuits are available in the following package styles and are identified by the Suffix Letters indicated below: dual-in-line ceramic, dual-in-line frit-seal ceramic, dual-in-line plastic, ceramic flat package, and in chip form. Some types are only available in one or two package styles. The available package styles for any specific type are given in the technical data for this type. When order CMOS devices, it is important that the appropriate suffix letter be affixed to the type number of the device required. For example, a CD4016B in a dual-in-line ceramic package will be identified as the CD4016BD.

Package	Suffix Letters
Dual-In-Line Welded-Seal or Side-Brazed Ceramic	D
Dual-In-Line Frit-Seal Ceramic	F
Dual-In-Line Plastic	E
Ceramic Flat Package	K
TO-5 Style	T
Chip	H

**H Suffix**  
CMOS Chip

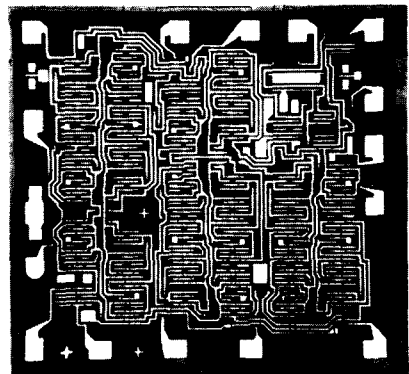



# Functional Diagrams

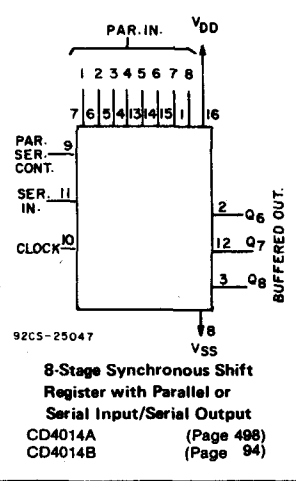
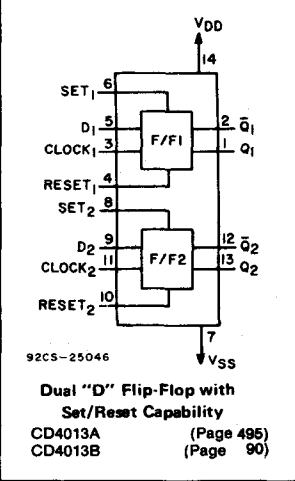
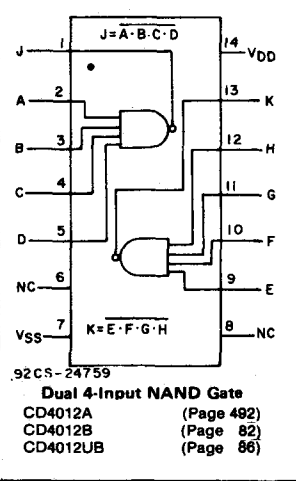
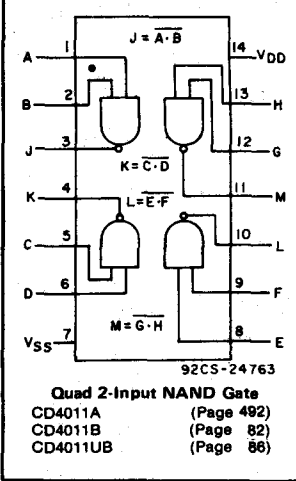
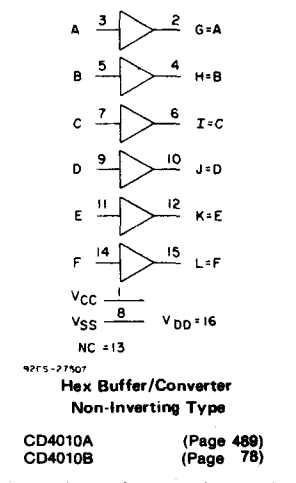
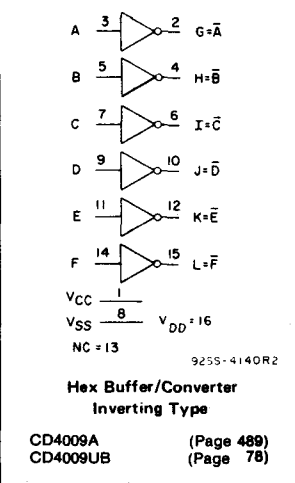
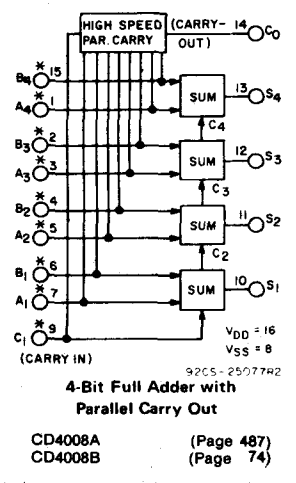
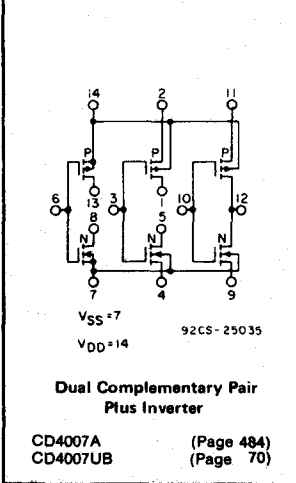
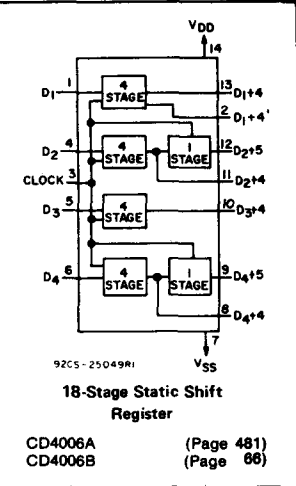
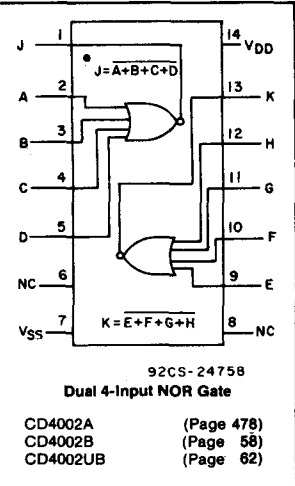
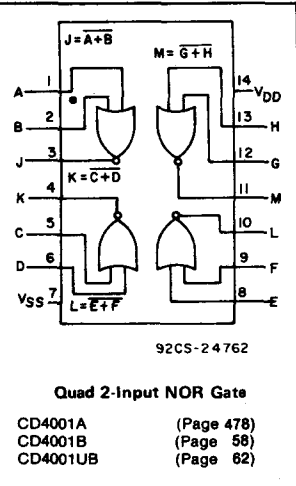
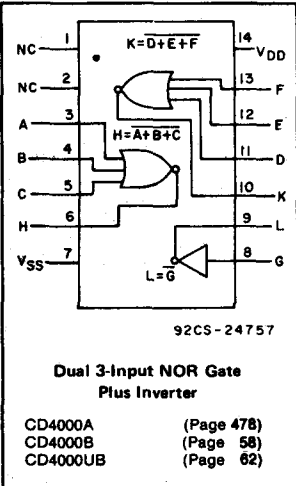

# Functional Diagrams

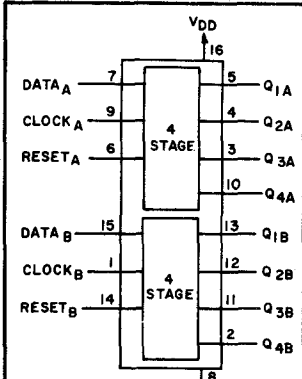
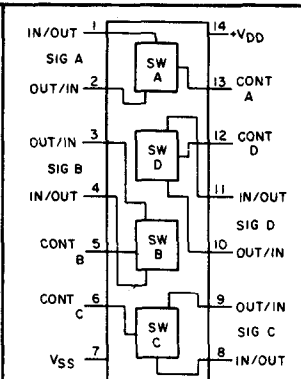
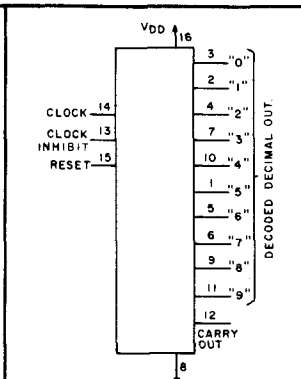
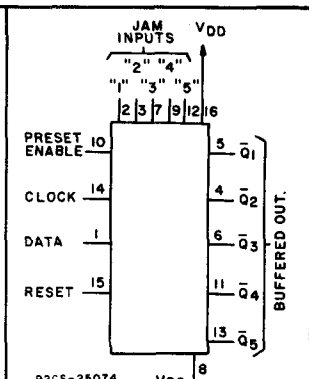
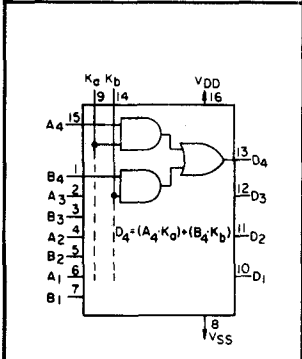
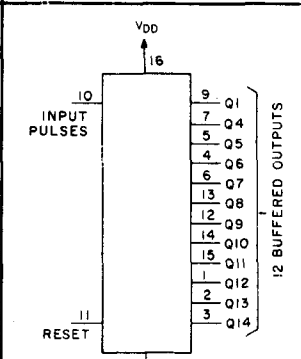
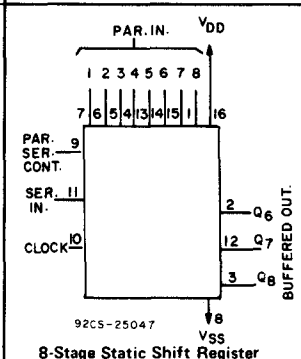
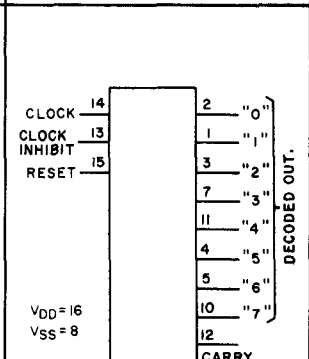
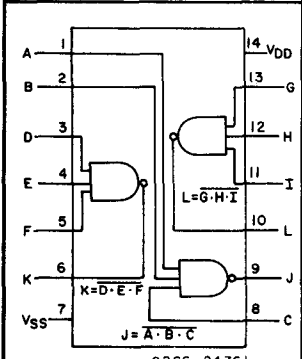
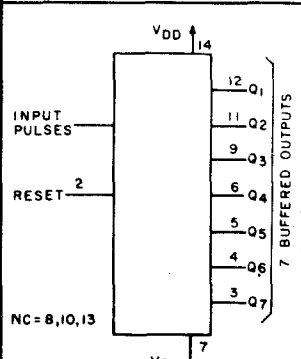
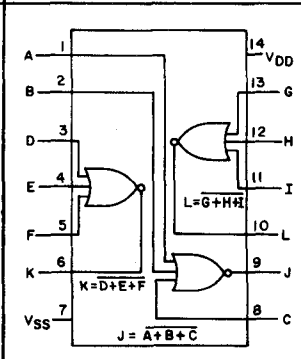
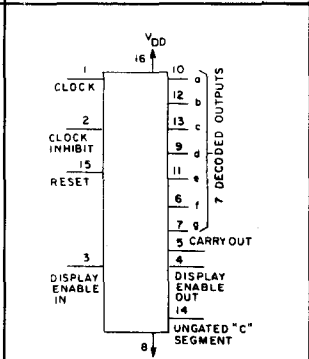
 <p>92CS-25048</p> <p><b>Dual 4-Stage Static Shift Register with Serial Input/Parallel Output</b>            CD4015A (Page 500)            CD4015B (Page 99)</p>	 <p>92CS-21627</p> <p><b>Quad Bilateral Switch</b>            CD4016A (Page 503)            CD4016B (Page 103)</p>	 <p>92CS-25072R2</p> <p><b>Decade Counter/Divider with 10 Decoded Decimal Outputs</b>            CD4017A (Page 507)            CD4017B (Page 108)</p>	 <p>92CS-25074</p> <p><b>Presettable Divide-by-"N" Counter Fixed or Programmable</b>            CD4018A (Page 511)            CD4018B (Page 113)</p>
 <p>92CS-25036</p> <p><b>Quad AND/OR Select Gate</b>            CD4019A (Page 514)            CD4019B (Page 118)</p>	 <p>92CS-25053R2</p> <p><b>14-Stage Binary Ripple Counter</b>            CD4020A (Page 516)            CD4020B (Page 122)</p>	 <p>92CS-25047</p> <p><b>8-Stage Static Shift Register Asynchronous Parallel or Synchronous Serial Input/Serial Output</b>            CD4021A (Page 519)            CD4021B (Page 94)</p>	 <p>92CS-25073R2</p> <p><b>Divide-by-8 Counter/Divider with 8 Decoded Decimal Outputs</b>            CD4022A (Page 522)            CD4022B (Page 108)</p>
 <p>92CS-24761</p> <p><b>Triple 3-Input NAND Gate</b>            CD4023A (Page 492)            CD4023B (Page 82)            CD4023UB (Page 86)</p>	 <p>92CS-25051R3</p> <p><b>7-Stage Ripple-Carry Binary Counter/Divider</b>            CD4024A (Page 525)            CD4024B (Page 122)</p>	 <p>92CS-24760</p> <p><b>Triple 3-Input NOR Gate</b>            CD4025A (Page 478)            CD4025B (Page 58)            CD4025UB (Page 62)</p>	 <p>92CS-25078R1</p> <p><b>Decade Counter/Divider with 7-Segment Display Outputs and Display Enable</b>            CD4026A (Page 528)            CD4026B (Page 126)</p>

# Functional Diagrams

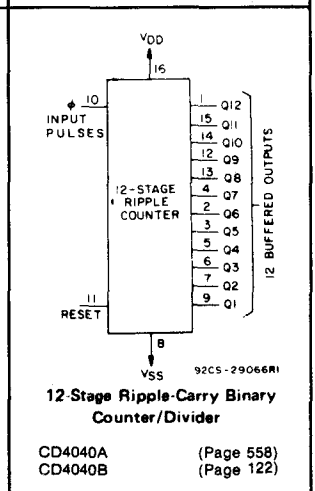
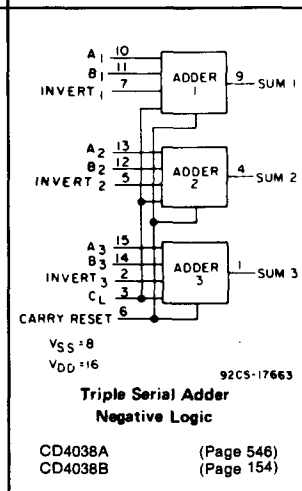
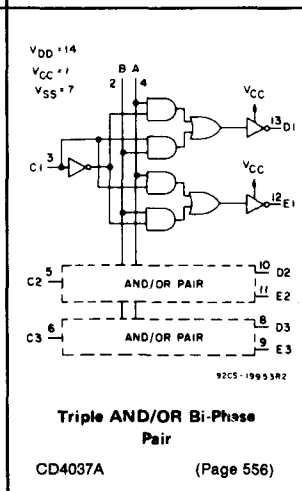
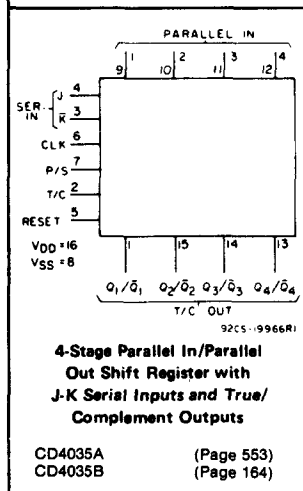
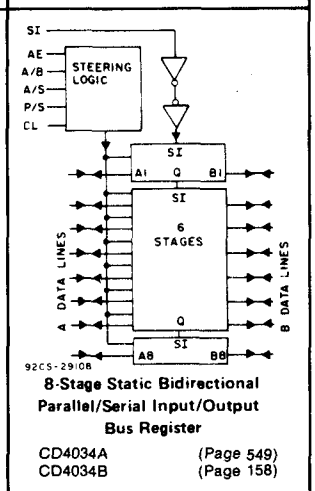
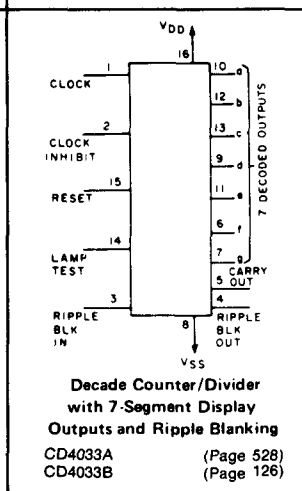
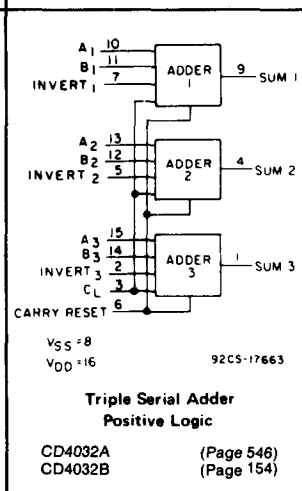
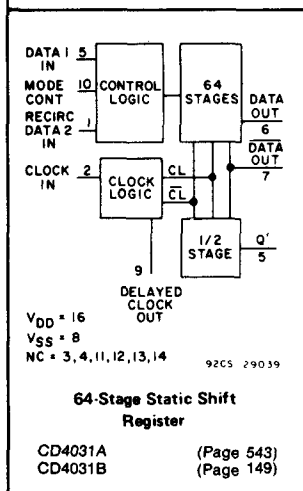
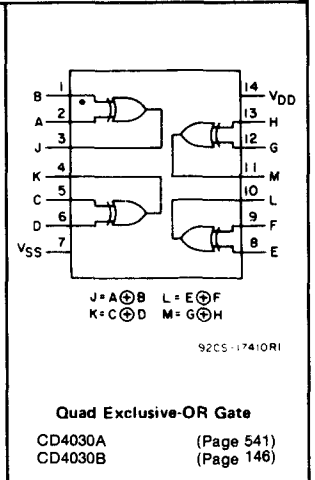
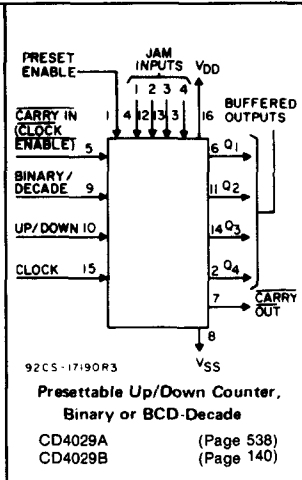
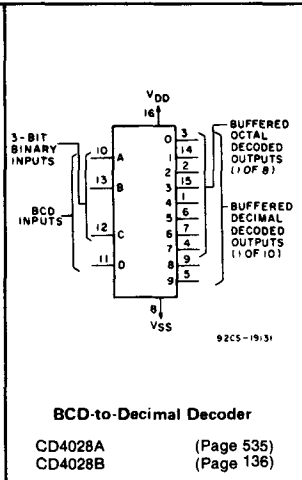
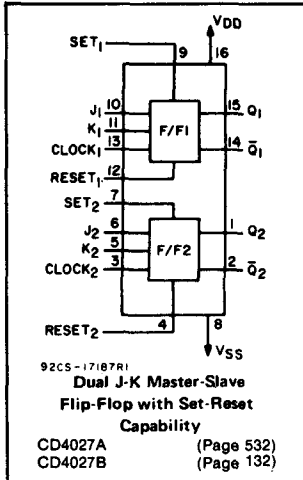

# Functional Diagrams

<p><b>Quad True/Complement Buffer</b></p> <p>CD4041A (Page 561) CD4041UB (Page 169)</p>	<p><b>Quad Clocked "D" Latch</b></p> <p>CD4042A (Page 565) CD4042B (Page 172)</p>	<p><b>Quad 3-State NOR R/S Latch</b></p> <p>CD4043A (Page 568) CD4043B (Page 176)</p>	<p><b>Quad 3-State NAND R/S Latch</b></p> <p>CD4044A (Page 568) CD4044B (Page 176)</p>
<p><b>21-Stage Counter</b></p> <p>CD4045A (Page 571) CD4045B (Page 180)</p>	<p><b>Micropower Phase-Locked Loop</b></p> <p>CD4046A (Page 574) CD4046B (Page 184)</p>		
<p><b>Low-Power Monostable/Astable Multivibrator</b></p> <p>CD4047A (Page 578) CD4047B (Page 190)</p>	<p><b>Multi-Function Expandable 8-Input Gate</b></p> <p>CD4048A (Page 585) CD4048B (Page 197)</p>	<p><b>Hex Buffer/Converter Inverting Type</b></p> <p>CD4049A (Page 590) CD4049UB (Page 202)</p>	

# Functional Diagrams

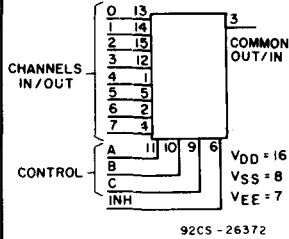
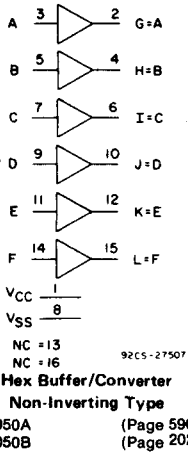

Single 8-Channel Analog Multiplexer/Demultiplexer  
CD4051B (Page 206)

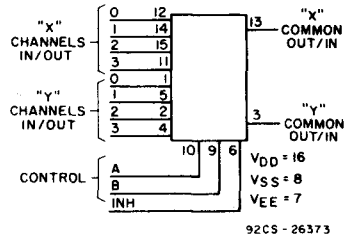

Differential 4-Channel Analog Multiplexer/Demultiplexer  
CD4052B (Page 206)

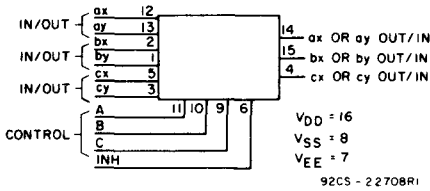

Triple 2-Channel Multiplexer/Demultiplexer  
CD4053B (Page 206)

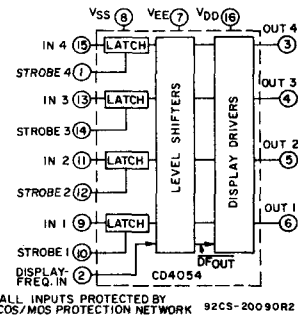

4-Segment Liquid-Crystal Display Driver  
CD4054B (Page 213)

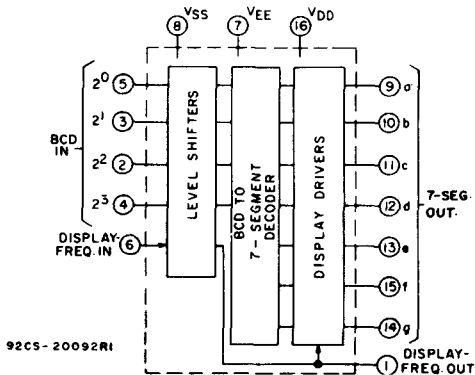

BCD-to-7-Segment Decoder/Driver with "Display-Frequency" Output Liquid-Crystal Display Driver  
CD4055B (Page 213)

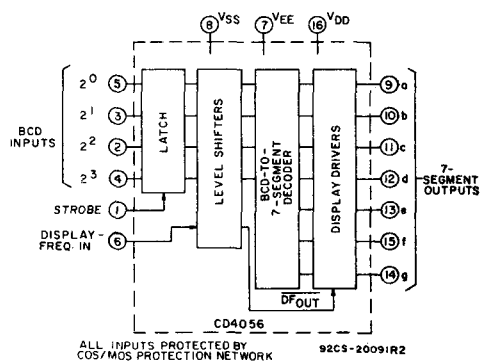

BCD-to-7-Segment Decoder/Driver with Strobed-Latch Function Liquid-Crystal Display Driver  
CD4056B (Page 213)

# Functional Diagrams

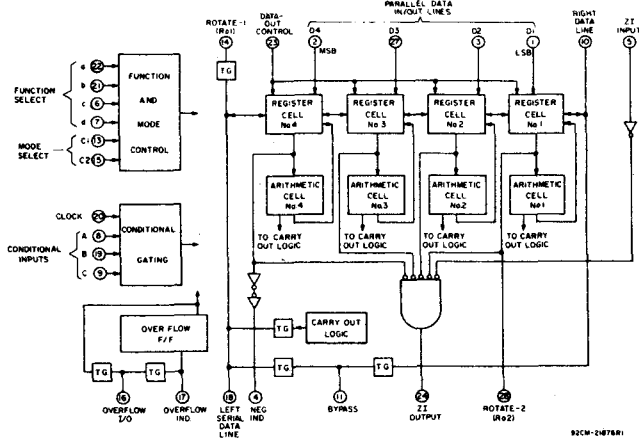

**4-bit Arithmetic Logic Unit**  
CD4057A (page 593)

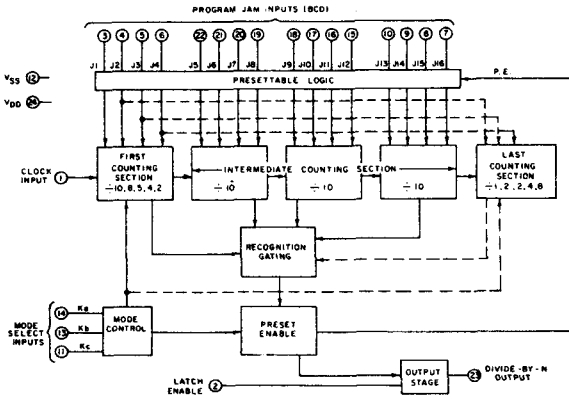

**Programmable Divide-by-'N' Counter**  
CD4059A (Page 601)

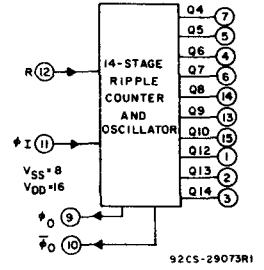

**14-Stage Ripple-Carry Binary Counter and Oscillator**  
CD4060A (Page 609)  
CD4060B (Page 218)

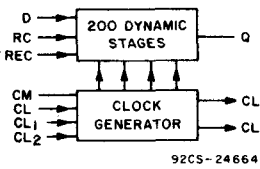

**200-Stage Dynamic Shift Register**  
CD4062A (Page 612)

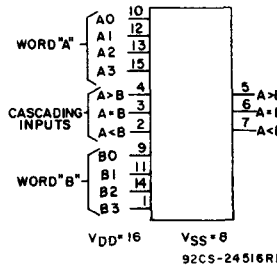

**4-bit Magnitude Comparator**  
CD4063B (Page 222)

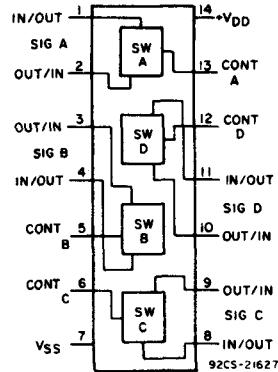

**Quad Bilateral Switch**  
CD4066A (Page 616)  
CD4066B (Page 226)

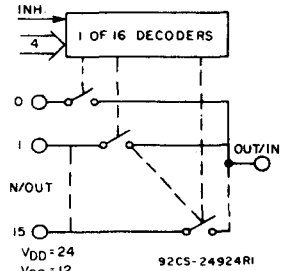

**16-Channel Multiplexer/Demultiplexer**  
CD4067B (Page 231)

# Functional Diagrams

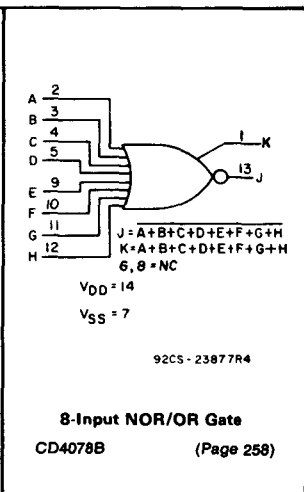
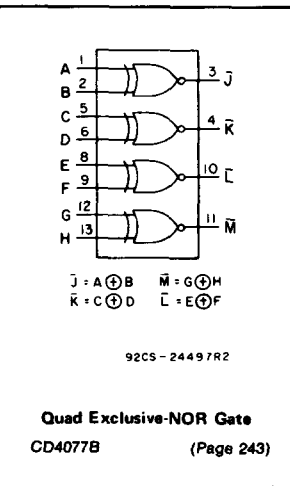
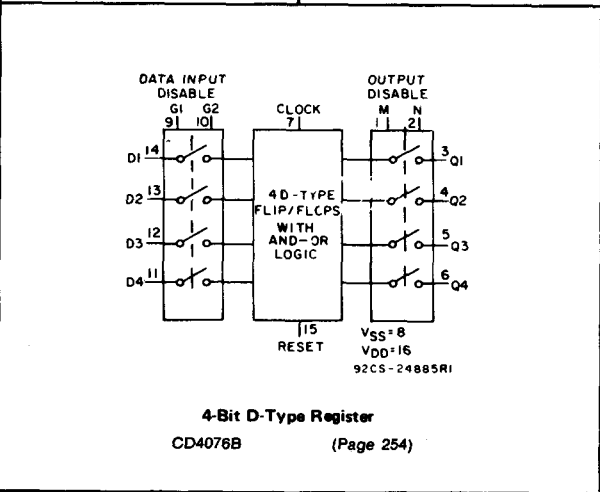
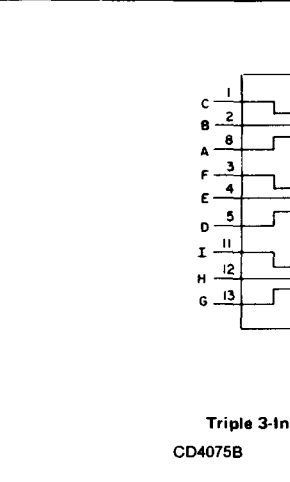
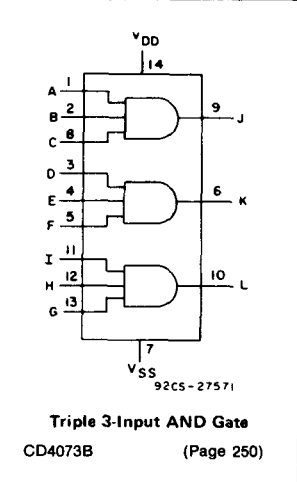
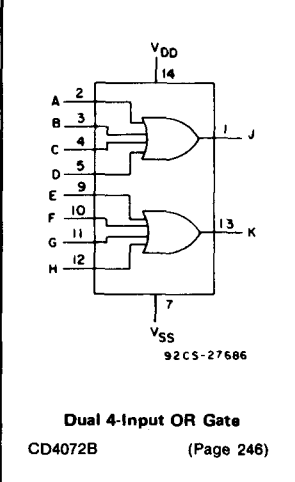
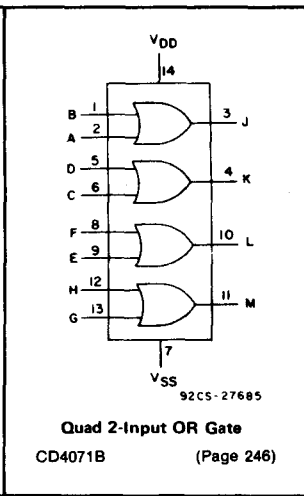
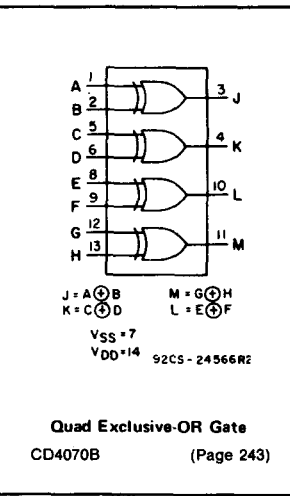
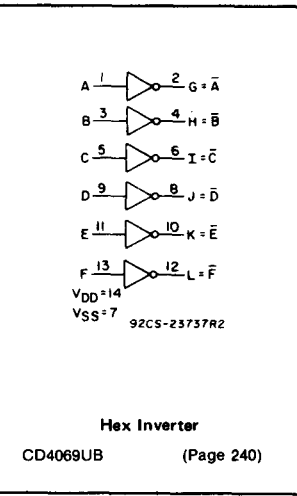
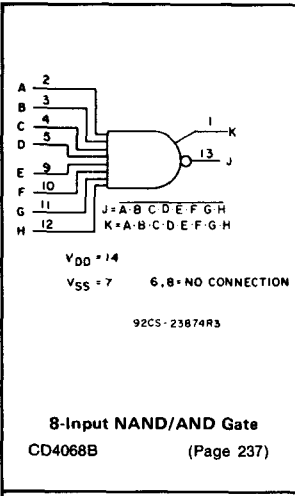

# Functional Diagrams

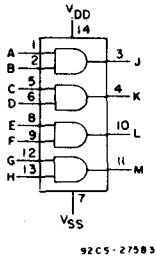

**Quad 2-Input AND Gate**  
CD4081B (Page 250)

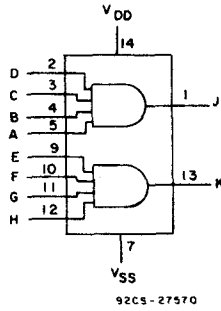

**Dual 4-Input AND Gate**  
CD4082B (Page 250)

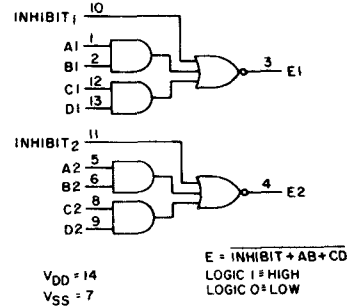

**Dual 2-Wide, 2-Input AND-OR-INVERT (AOI) Gate**  
CD4085B (Page 261)

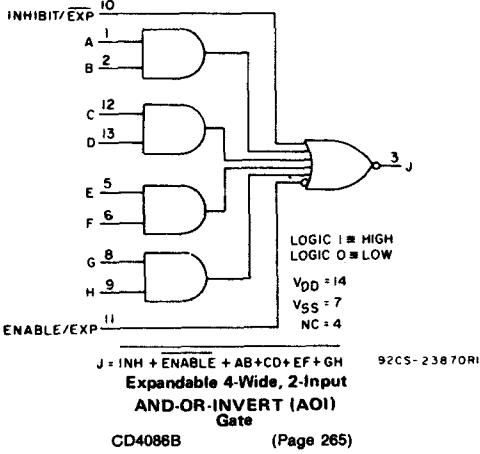

**Expandable 4-Wide, 2-Input AND-OR-INVERT (AOI) Gate**  
CD4088B (Page 265)

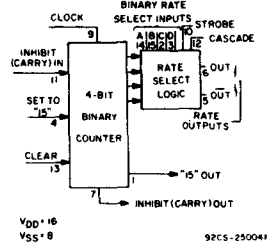

**Binary Rate Multiplier**  
CD4089B (Page 269)

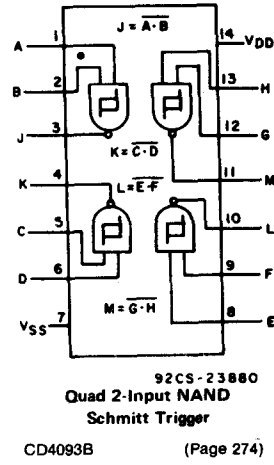

**Quad 2-Input NAND Schmitt Trigger**  
CD4093B (Page 274)

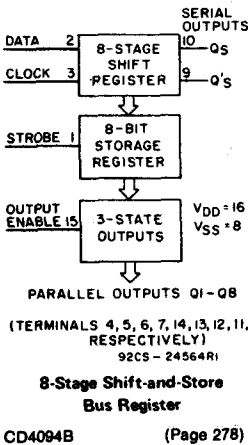

**8-Stage Shift-and-Store Bus Register**  
CD4094B (Page 278)

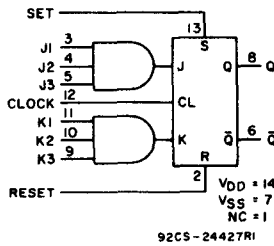

**Gated J-K Master-Slave Flip-Flop, Non-Inverting Inputs**  
CD4095B (Page 282)

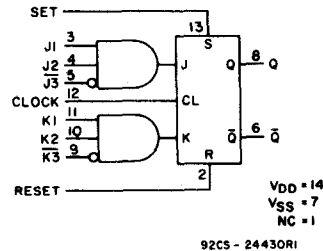

**Gated J-K Master-Slave Flip-Flop, Inverting and Non-Inverting Inputs**  
CD4096B (Page 282)



# Functional Diagrams

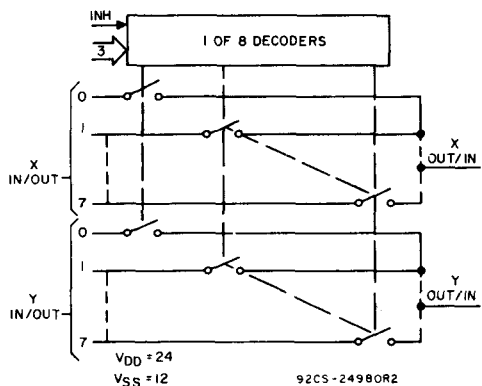

VDD = 24  
VSS = 12  
92CS-24980R2  
**Differential 8-Channel  
Multiplexer/Demultiplexer**  
CD4097B (Page 231)

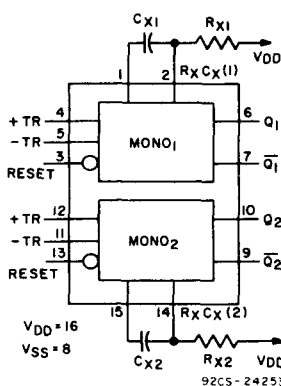

VDD = 16  
VSS = 8  
92CS-24253  
**Dual Monostable  
Multivibrator**  
CD4098B (Page 286)

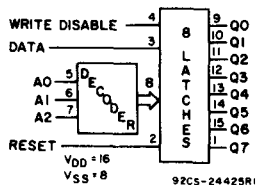

92CS-24425R1  
**8-Bit Addressable Latch**  
CD4099B (Page 291)

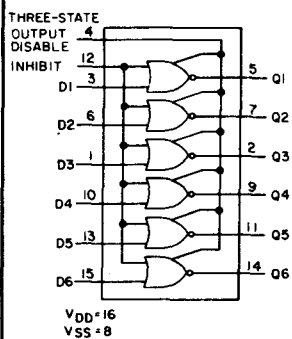

VDD = 16  
VSS = 8  
92CS-22921R1  
**Strobed Hex Inverter/Buffer**  
CD4502B (Page 295)

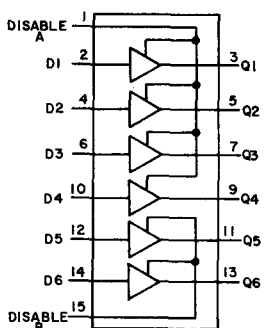

DISABLE A (pin 1)  
DISABLE B (pin 15)  
16 = VDD 8 = VSS  
92CS-32392R1  
**Hex Buffer  
3-State Non-Inverting**  
CD4503B (Page 298)

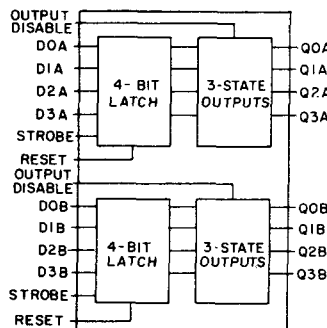

92CS-27494R1  
**Dual 4-Bit Latch**  
CD4508B (Page 301)

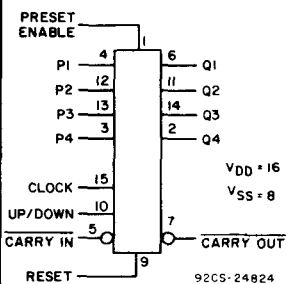

VDD = 16  
VSS = 8  
92CS-24824  
**BCD Presettable Up/Down  
Counter**  
CD4510B (Page 305)

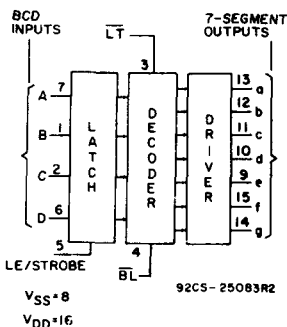

92CS-25083R2  
VSS = 8  
VDD = 16  
**BCD-to-7-Segment  
Latch Decoder Driver**  
CD4511B (Page 311)

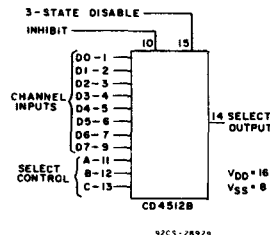

92CS-28929  
VDD = 16  
VSS = 8  
**8-Channel Data Selector**  
CD4512B (Page 316)

# Functional Diagrams

<p><b>4-Bit Latch/4-to-16 Line Decoder</b> 92CS-24597</p> <p><b>CD4514B</b> (Page 319) <b>CD4515B</b> (Page 319) Output "High" on Select      Output "Low" on Select</p>	<p><b>Binary Presettable Up/Down Counter</b> 92CS-24824</p> <p><b>CD4516B</b> (Page 305)</p>	<p><b>Dual 64-Bit Shift Register</b> 92CS-30371</p> <p><b>CD4517B</b> (Page 323)</p>
<p><b>Dual Up Counter</b> 92CS-24506R1</p> <p><b>CD4518B</b> (Page 328) BCD <b>CD4520B</b> (Page 328) Binary</p>	<p><b>BCD Rate Multiplier</b> 92CS-24913R1</p> <p><b>CD4527B</b> (Page 333)</p>	<p><b>8-Bit Priority Encoder</b> 92CS-26360R1</p> <p><b>CD4532B</b> (Page 338)</p>
<p><b>Programmable Timer</b> 92CS-30373</p> <p><b>CD4538B</b> (Page 342)</p>	<p><b>Dual Precision Monostable Multivibrator</b> 92CS-24253</p> <p><b>CD4538B</b> (Page 350)</p>	<p><b>Programmable Timer</b> 92CS-35066</p> <p><b>CD4541B</b> (Page 356)</p>

# Functional Diagrams

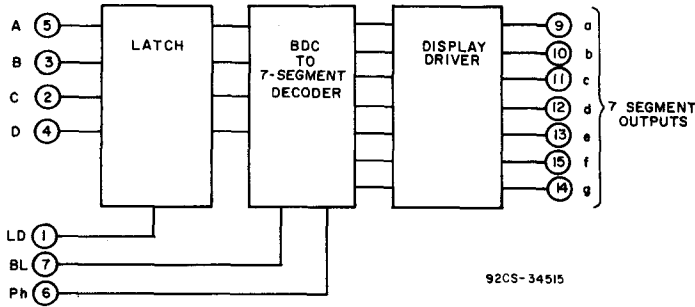

**BCD-to-7-Segment Latch/Decoder/Driver**

CD4543B (Page 360)

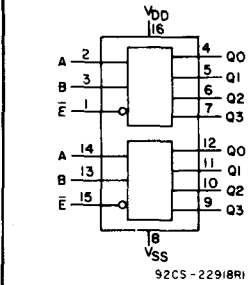

**Dual Binary-to-1-of-4 Decoder/Demultiplexer Output "High" on Select**

CD4555B (Page 366)

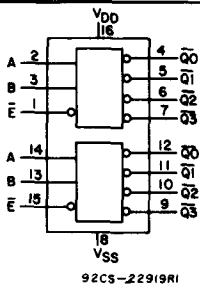

**Dual Binary-to-1-of-4 Decoder/Demultiplexer Output "Low" on Select**

CD4556B (Page 366)

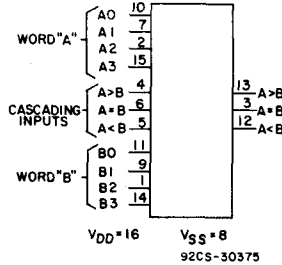

**4-Bit Magnitude Comparator**

CD4585B (Page 371)

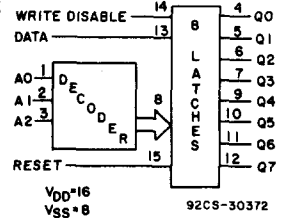

**8-Bit Addressable Latch**

CD4724B (Page 375)

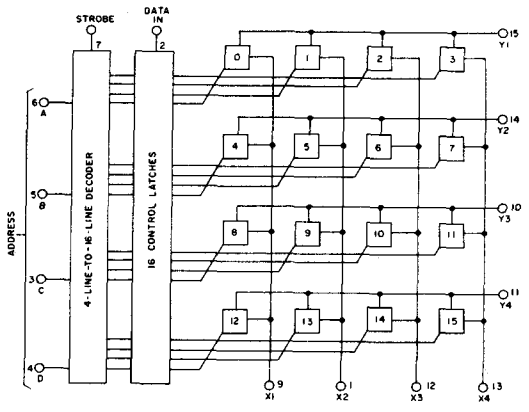

**4-by-4 Crosspoint Switch with Control Memory**

CD22100 (Page 638)

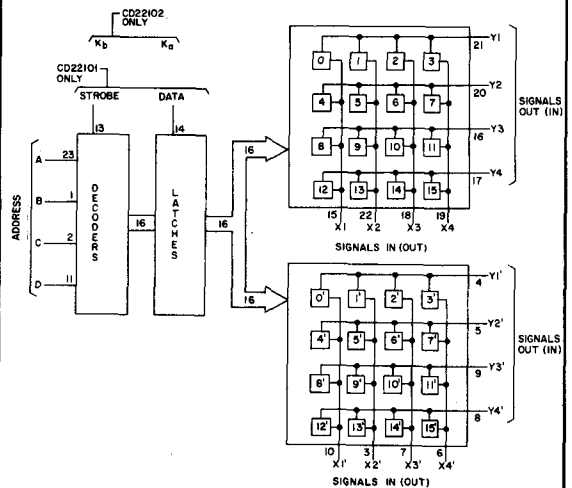

**4-by-4-by-2 Crosspoint Switch with Control Memory**

CD22101 (Page 641)

CD22102 (Page 641)

# Functional Diagrams

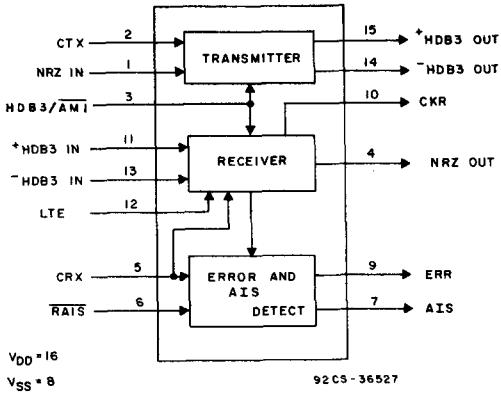

**HDB3 Transcoder**

CD22103 (Page 649)

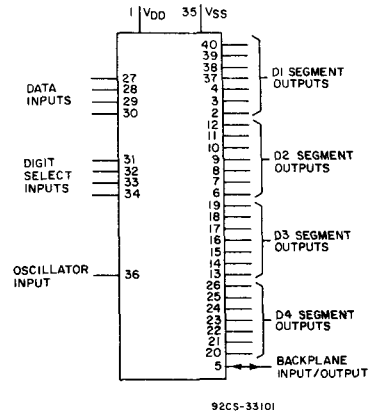

**4-Digit Decoder Driver**

CD22104 (Page 656) Hexadecimal Display  
 CD22104A (Page 656) Decimal Display

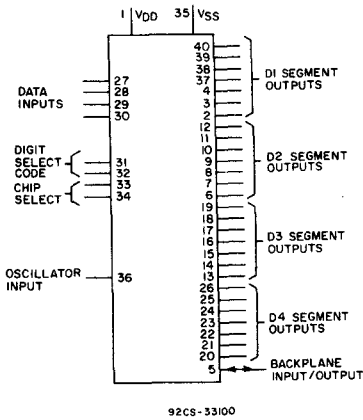

**4-Digit Decoder Driver**

CD22105 (Page 661) Hexadecimal Display  
 CD22105A (Page 661) Decimal Display

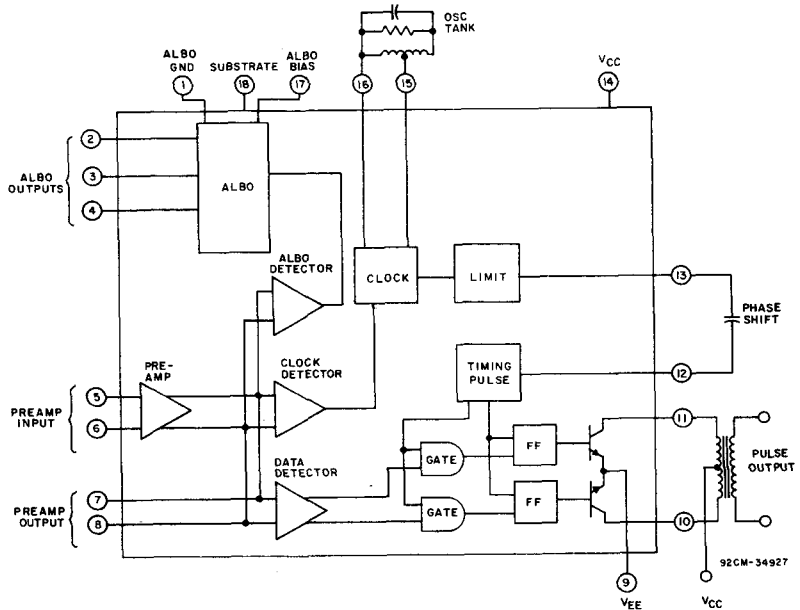

**PCM Line Repeater**

CD22301 (Page 666)

# Functional Diagrams

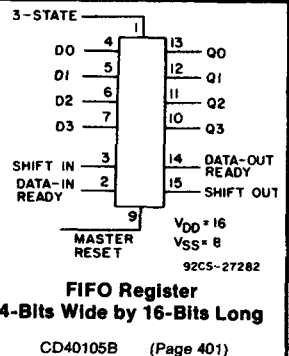
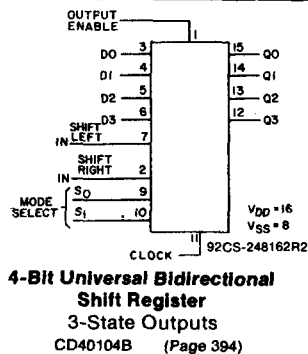
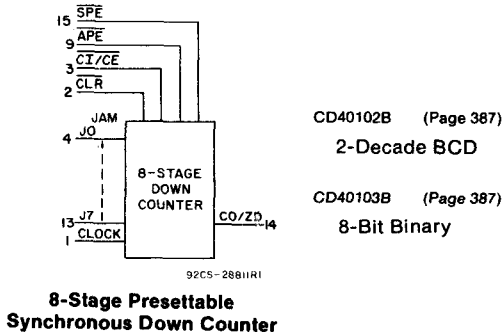
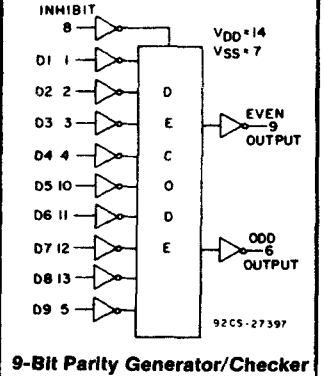
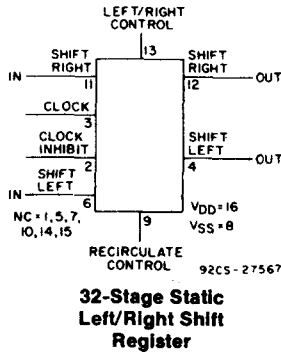
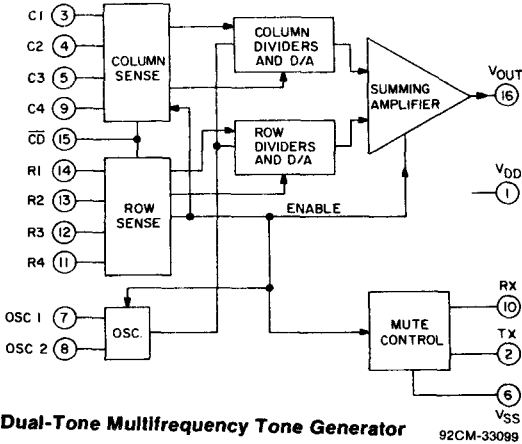
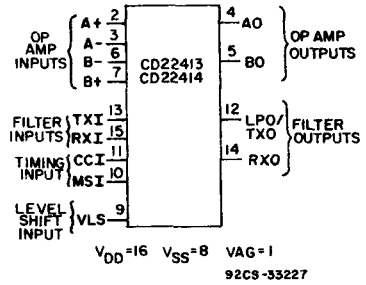
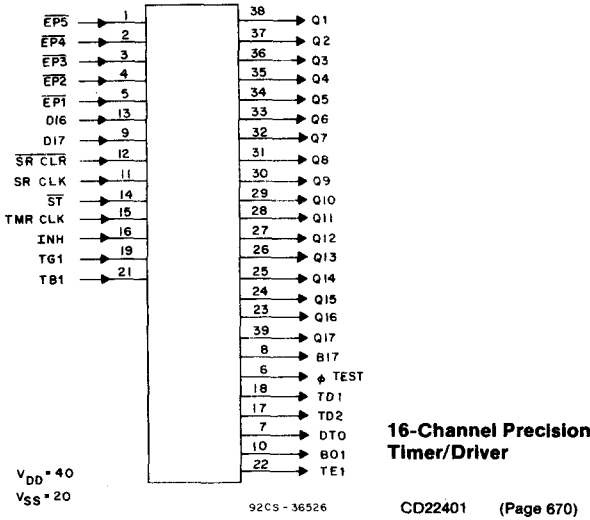

# Functional Diagrams

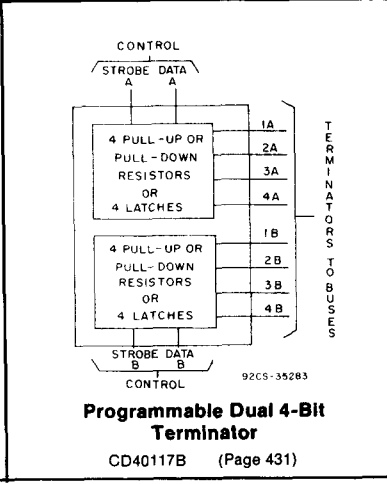
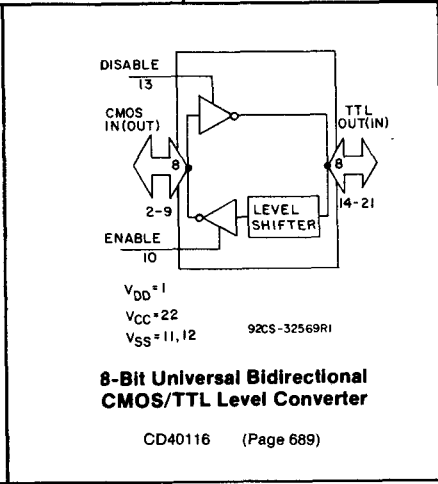
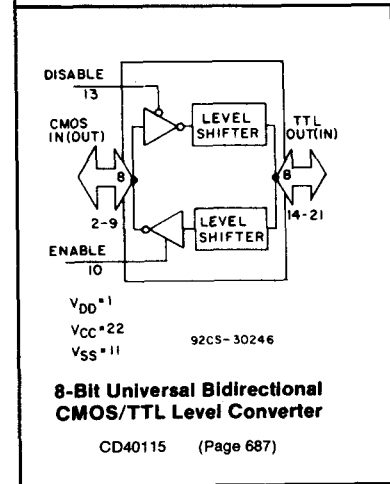
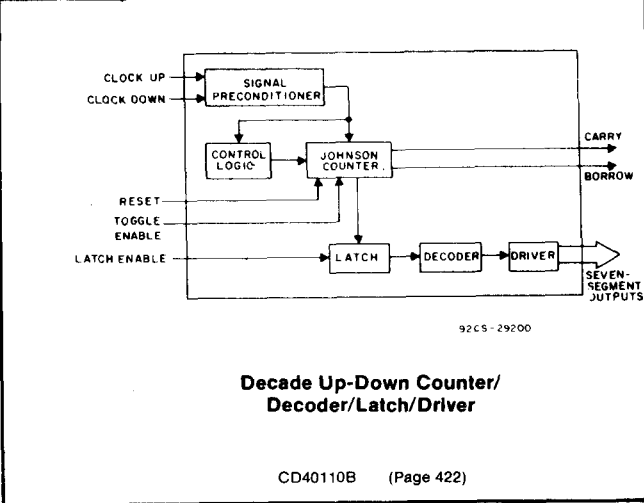
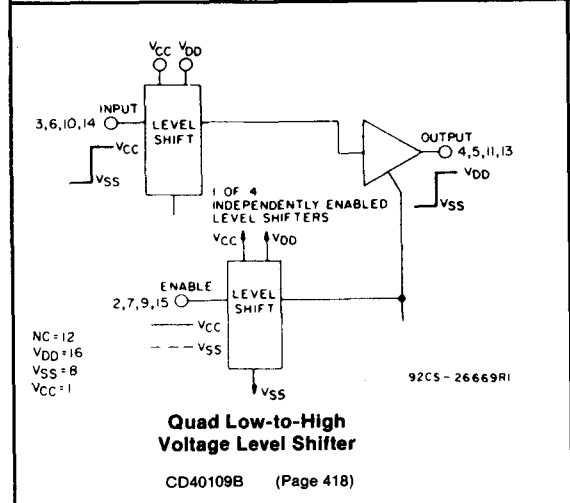
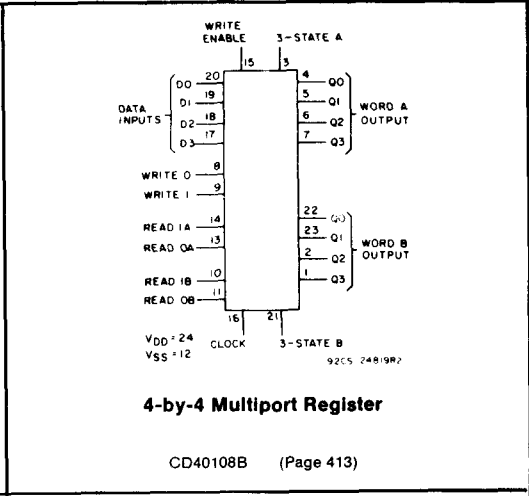
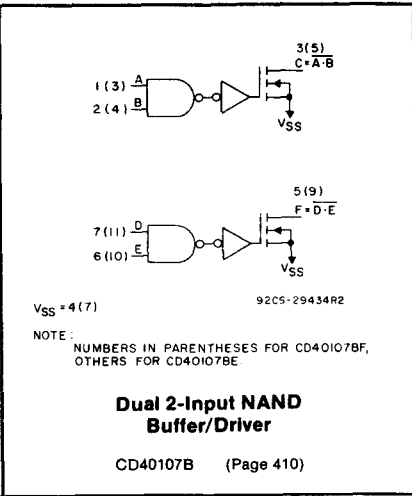
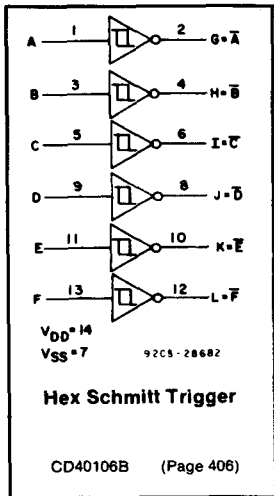

# Functional Diagrams

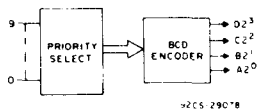

**10-Line-to-4-Line BCD Priority Encoder**

CD40147B (Page 435)

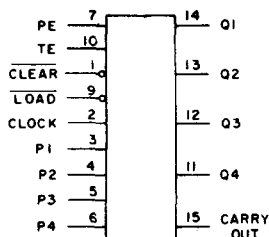

$V_{DD} = 16$   
 $V_{SS} = 8$   
92CS - 28628R1

**Synchronous 4-Bit Counter**

CD40162B (Page 438) Decade with Synchronous Clear  
CD40163B (Page 438) Binary with Synchronous Clear  
CD40160B (Page 438) Decade with Asynchronous Clear  
CD40161B (Page 438) Binary with Asynchronous Clear

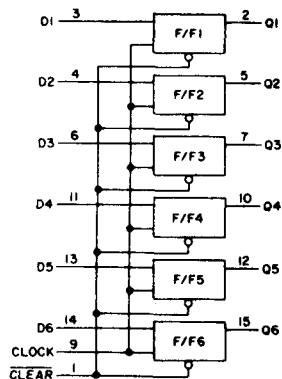

$V_{SS} = 8$   
 $V_{DD} = 16$   
92CS - 29251

**Hex "D" Type Flip-Flop**

CD40174B (Page 445)

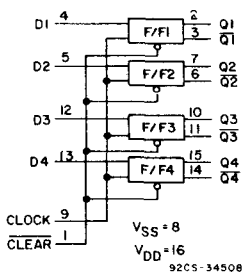

**Quad "D"-Type Flip-Flop**

CD40175B (Page 449)

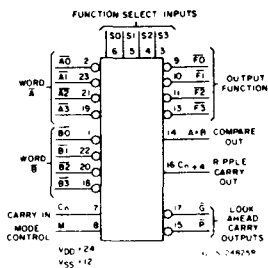

Active-Low Data Active-High Data

CD40181B (Page 455)

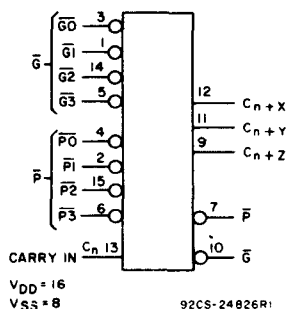
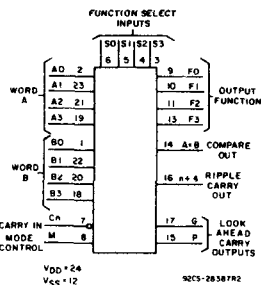

**Look-Ahead Carry Generator**

CD40182B (Page 460)

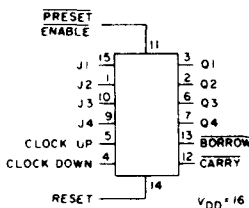

**Presettable Up/Down Counter (Dual Clock with Reset)**

CD40192B (Page 464) BCD  
CD40193B (Page 464) Binary

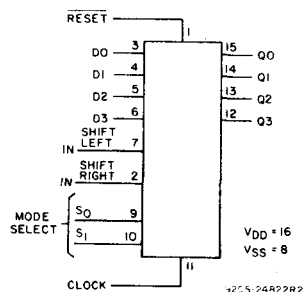

**4-Bit Universal Bidirectional Shift Register with Asynchronous Master Reset**

CD40194B (Page 394)

# Functional Diagrams

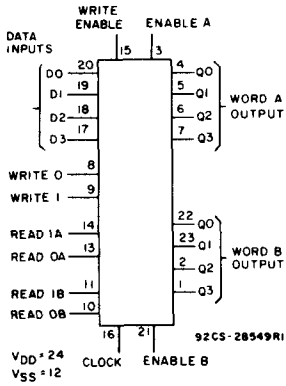

**4-by-4 Multiport Register**

CD40208B (Page 469)

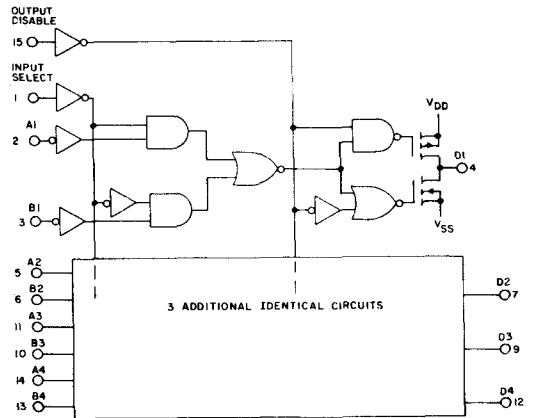

**Quad 2-Line-to-1-Line  
Data Selector/Multiplexer**

CD40257B (Page 474)

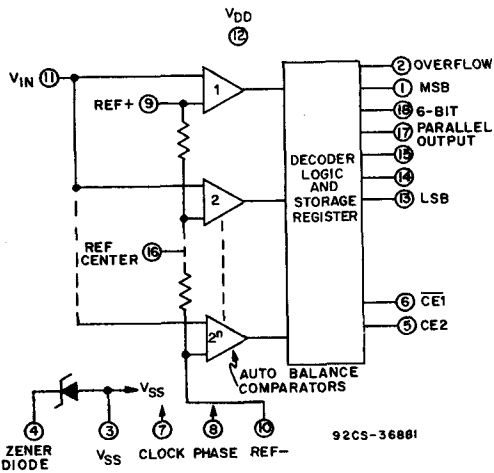

**6-Bit Flash A/D Converter**

CA3300 (Page 620)

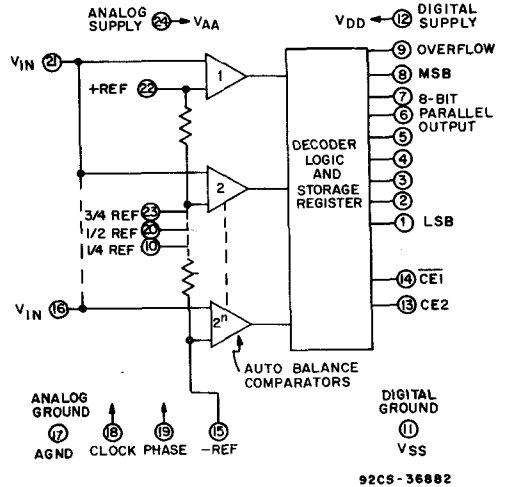

**8-Bit Flash A/D Converter**

CA3308 (Page 631)  
CA3308A (Page 631)



## Cross-Reference Guide

This guide provides a quick reference to a wide variety of industry CMOS logic integrated circuits that can be replaced by RCA types.

The RCA types listed as replacements are electrically and mechanically equivalent to the corresponding industry types and can be used as direct replacements in most applications. The recommendations are based on the electrical and mechanical data published by various solid-state device manufacturers.

Before substituting any replacement type in a particular application, the user should review the operating conditions of the particular application with the specifications of the type he is planning to use as the substitute type.

Industry Type	RCA Replacement Type
CD4000CN	CD4000AE
CD4000MD	CD4000AD
CD4000MJ	CD4000AF
CD4001BCJ	CD4001BF
CD4001BCN	CD4001BE
CD4001BMD	CD4001BD
CD4001BMJ	CD4001BF
CD4002BCJ	CD4002BE
CD4002BCN	CD4002BE
CD4002BMD	CD4002BD
CD4002BMJ	CD4002BF
CD4002CN	CD4002AE
CD4002MD	CD4002AD
CD4002MJ	CD4002AF
CD4006BCJ	CD4006BF
CD4006BCN	CD4006BE
CD4006BMD	CD4006BD
CD4006BMJ	CD4006BF
CD4006CN	CD4006AE
CD4006MD	CD4006AD
CD4006MJ	CD4006AF
CD4007CN	CD4007AE
CD4007MD	CD4007AD
CD4007MJ	CD4007AF
CD4007UBMD	CD4007UBD
CD4007UBCN	CD4007UBE
CD4008BCJ	CD4008BF
CD4008BCN	CD4008BE
CD4008BMD	CD4008BD
CD4008BMJ	CD4008BF
CD4009CN	CD4009AE
CD4009MD	CD4009AD
CD4009MJ	CD4009AF
CD4010CN	CD4010AE
CD4010MD	CD4010AD

Industry Type	RCA Replacement Type
CD4010MJ	CD4010AF
CD4011BCJ	CD4011BF
CD4011BCN	CD4011BE
CD4011BMD	CD4011BD
CD4011BMJ	CD4011BF
CD4012BMD	CD4012BD
CD4012CN	CD4012AE
CD4012MD	CD4012AD
CD4012MJ	CD4012AF
CD4013BCJ	CD4013BF
CD4013BCN	CD4013BE
CD4013BMD	CD4013BD
CD4013BMJ	CD4013BF
CD4014BCJ	CD4014BF
CD4014BMD	CD4014BD
CD4014BMJ	CD4014BF
CD4014CN	CD4014AE
CD4014MD	CD4014AD
CD4014MJ	CD4014AF
CD4015BCJ	CD4015BF
CD4015BCN	CD4015BE
CD4015BMD	CD4015BD
CD4015BMJ	CD4015BF
CD4015CN	CD4015AE
CD4015MD	CD4015AD
CD4015MJ	CD4015AF
CD4016BCJ	CD4016BF
CD4016BCN	CD4016BE
CD4016BMD	CD4016BD
CD4016BMJ	CD4016BF
CD4016CN	CD4016AE
CD4016MD	CD4016AD
CD4016MJ	CD4016AF
CD4017BCJ	CD4017BF
CD4017BCN	CD4017BE

Industry Type	RCA Replacement Type
CD4017BMD	CD4017BD
CD4017BMJ	CD4017BF
CD4018BCN	CD4018BE
CD4018BMD	CD4018BD
CD4018BMJ	CD4018BF
CD4019BCJ	CD4018BF
CD4019BCJ	CD4019BE
CD4019BMD	CD4019BD
CD4019BMJ	CD4019BF
CD4020BCJ	CD4020BF
CD4020BCN	CD4020BE
CD4020BMD	CD4020BD
CD4020BMJ	CD4020BF
CD4021BCJ	CD4021BF
CD4021BCN	CD4021BE
CD4021BMD	CD4021BD
CD4021BMJ	CD4021BF
CD4021CN	CD4021AE
CD4021MD	CD4021AD
CD4021MJ	CD4021AF
CD4022BCJ	CD4022BF
CD4022BCN	CD4022BE
CD4022BMD	CD4022BD
CD4022BMJ	CD4022BF
CD4023BCJ	CD4023BF
CD4023BCN	CD4023BE
CD4023BMD	CD4023BD
CD4023BMJ	CD4023BF
CD4023CN	CD4023AE
CD4023MD	CD4023AD
CD4023MJ	CD4023AF
CD4024BCJ	CD4024BF
CD4024BCN	CD4024BE
CD4024BMD	CD4024BD
CD4024BMJ	CD4024BF

## Cross-Reference Guide

Industry Type	RCA Replacement Type	Industry Type	RCA Replacement Type	Industry Type	RCA Replacement Type
CD4025BCJ	CD4025BF	CD4046BCN	CD4046BE	CD4073BCJ	CD4073BF
CD4025BCN	CD4025BE	CD4046BMD	CD4046BD	CD4073BCN	CD4073BE
CD4025BMD	CD4025BD	CD4046BMJ	CD4046BF	CD4073BMD	CD4073BD
CD4025BMJ	CD4025BF	CD4047BCN	CD4047BE	CD4073BMJ	CD4073BF
CD4025CN	CD4025AE	CD4047BMD	CD4047BD	CD4075BCJ	CD4075BF
CD4025MD	CD4025AD	CD4047BMJ	CD4047BF	CD4075BCN	CD4075BE
CD4025MJ	CD4025AF	CD4048BCJ	CD4048BF	CD4075BMD	CD4075BD
CD4027BCJ	CD4027BF	CD4048BCN	CD4048BE	CD4075BMJ	CD4075BF
CD4027BCN	CD4027BE	CD4048BMD	CD4048BD	CD4076BCJ	CD4076BF
CD4027BMD	CD4027BD	CD4048BMJ	CD4048BF	CD4076BCN	CD4076BE
CD4027BMJ	CD4027BF	CD4049BMD	CD4049BD	CD4076BMD	CD4076BD
CD4027DM	CD4027BD	CD4049BPC	CD4049BE	CD4076BMJ	CD4076BF
CD4028BCJ	CD4028BF	CD4049CN	CD4049AE	CD4081BCJ	CD4081BF
CD4028BCN	CD4028BE	CD4049MD	CD4049AD	CD4081BCN	CD4081BE
CD4028BMD	CD4028BD	CD4049MJ	CD4049AF	CD4081BMD	CD4081BD
CD4028BMJ	CD4028BF	CD4050BCJ	CD4050BF	CD4081BMJ	CD4081BF
CD4029BCJ	CD4029BF	CD4050BCN	CD4050BE	CD4089BCJ	CD4089BE
CD4029BCN	CD4029BE	CD4050BMD	CD4050BD	CD4089BMD	CD4089BD
CD4029BMD	CD4029BD	CD4050BMJ	CD4050BF	CD4089BMJ	CD4089BF
CD4029BMJ	CD4029BF	CD4051BCJ	CD4051BF	CD4093BCJ	CD4093BF
CD4030BMD	CD4030BD	CD4051BMD	CD4051BD	CD4093BCN	CD4093BE
CD4030MD	CD4030AD	CD4051BMJ	CD4051BF	CD4093BMD	CD4093BD
CD4030MJ	CD4039AF	CD4052BCJ	CD4052BF	CD4093BMJ	CD4093BF
CD4031BCN	CD4031BE	CD4052BCN	CD4052BE	CD4099BCJ	CD4099BF
CD4031BDM	CD4031BD	CD4052BMD	CD4052BD	CD4099BCN	CD4099BE
CD4031BMD	CD4031BD	CD4052BMJ	CD4052BF	CD4099BMD	CD4099BD
CD4031BMJ	CD4031BF	CD4053BCJ	CD4053BF	CD4099BMJ	CD4099BF
CD4034BCN	CD4034BE	CD4053BCN	CD4053BE	CD4503BCJ	CD4503BF
CD4034BMD	CD4034BD	CD4053BMD	CD4053BD	CD4503BCN	CD4503BE
CD4034BMJ	CD4034BF	CD4053BMJ	CD4053BF	CD4503BMJ	CD4503BF
CD4035BCN	CD4035BE	CD4060BCJ	CD4060BF	CD4503BMD	CD4503BD
CD4035BMD	CD4035BD	CD4060BCN	CD4060BE	CD4510BCJ	CD4510BF
CD4035BMJ	CD4035BF	CD4060BMD	CD4060BD	CD4510BCN	CD4510BE
CD4040BCJ	CD4040BF	CD4060BMJ	CD4060BF	CD4510BMD	CD4510BD
CD4040BCN	CD4040BE	CD4066BCJ	CD4066BF	CD4510BMJ	CD4510BF
CD4040BMD	CD4040BD	CD4066BCN	CD4066BE	CD4511BCJ	CD4511BF
CD4040BMJ	CD4040BF	CD4066BMD	CD4066BD	CD4511BCN	CD4511BE
CD4041BMD	CD4041UBD	CD4066BMJ	CD4066BF	CD4511BMD	CD4511BD
CD4041CJ	CD4041UBF	CD4066BPC	CD4066BE	CD4512BCJ	CD4512BF
CD4041CN	CD4041AE	CD4069CN	CD4069AE	CD4512BCN	CD4512BE
CD4041MD	CD4041AD	CD4069MD	CD4069AD	CD4512BMD	CD4512BD
CD4041MJ	CD4041AF	CD4069MJ	CD4069AF	CD4512BMJ	CD4512BF
CD4042BCJ	CD4042BF	CD4069UBMD	CD4069UBD	CD4514BCJ	CD4514BF
CD4042BCN	CD4042BE	CD4070BCJ	CD4070BF	CD4514BCN	CD4514BE
CD4042BMD	CD4042BD	CD4070BCN	CD4070BE	CD4514BMD	CD4514BD
CD4042BMJ	CD4042BF	CD4070BMD	CD4070BD	CD4514BMJ	CD4514BF
CD4043BMD	CD4043BD	CD4070BMJ	CD4070BF	CD4515BCJ	CD4515BF
CD4043CN	CD4043AE	CD4070CN	CD4070AE	CD4515BCN	CD4515BE
CD4043MD	CD4043AD	CD4070MD	CD4070AD	CD4515BMD	CD4515BD
CD4043MJ	CD4043AF	CD4070MJ	CD4070AF	CD4515BMJ	CD4515BF
CD4044BMD	CD4044BD	CD4071BCJ	CD4071BF	CD4516BCJ	CD4516BF
CD4044CN	CD4044AE	CD4071BCN	CD4071BE	CD4516BCN	CD4516BE
CD4044MD	CD4044AD	CD4071BMD	CD4071BD	CD4516BMD	CD4516BD
CD4044MJ	CD4044AF	CD4071BMJ	CD4071BF	CD4516BMJ	CD4516BF
CD4045BMD	CD4045BD	CD4072BMD	CD4072BD	CD4518BCJ	CD4518BF

## Cross-Reference Guide

Industry Type	RCA Replacement Type
CD4518BCN	CD4518BE
CD4518BMD	CD4518BD
CD4518BMJ	CD4518BF
CD4520BCJ	CD4520BF
CD4520BCN	CD4520BE
CD4520BMD	CD4520BD
CD4520BMJ	CD4520BF
CD4527BCJ	CD4527BF
CD4527BCN	CD4527BE
CD4527BMD	CD4527BD
CD4528BCJ	CD4528BF
CD4528BCN	CD4528BE
CD4528BMD	CD4528BD
CD4528BMJ	CD4528BF
CD4538BCJ	CD4538BF
CD4538BCN	CD4538BE
CD4538BMD	CD4538BD
CD4538BMJ	CD4538BF
CD4543BCJ	CD4543BF
CD4543BCN	CD4543BE
CD4543BMD	CD4543BD
CD4543BMJ	CD4543BF
CD4724BCJ	CD4724BF
CD4724BCN	CD4724BE
CD4724BMD	CD4724BD
CD4724BMJ	CD4724BF
CD40106BCJ	CD40106BF
CD40106BCN	CD40106BE
CD40106BMD	CD40106BD
CD40106BMJ	CD40106BF
CD40106BMJ	CD40106BF
CD40161BCJ	CD40161BF
CD40161BCN	CD40161BE
CD40161BMD	CD40161BD
CD40161BMJ	CD40161BF
CD40162BCJ	CD40162BF
CD40162BCN	CD40162BE
CD40162BMD	CD40162BD
CD40162BMJ	CD40162BF
CD40163BCJ	CD40163BF
CD40163BCN	CD40163BE
CD40163BMD	CD40163BD
CD40163BMJ	CD40163BF
CD40174BCJ	CD40174BF
CD40174BCN	CD40174BE
CD40174BMD	CD40174BD
CD40174BMJ	CD40174BF
CD40175BCJ	CD40175BF
CD40175BMD	CD40175BD
CD40175BMJ	CD40175BF

Industry Type	RCA Replacement Type
CD40175BCN	CD40175BE
CD40192BCJ	CD40192BF
CD40192BCN	CD40192BE
CD40192BMD	CD40192BD
CD40192BMJ	CD40192BF
CD40193BCJ	CD40193BF
CD40193BCN	CD40193BE
CD40193BMD	CD40193BD
CD40193BMJ	CD40193BF
F4001BDC	CD4001BF
F4001BDM	CD4001BF
F4001BPC	CD4001BE
F4002BDC	CD4002BF
F4002BDM	CD4002BF
F4002BPC	CD4002BE
F4006BDC	CD4006BF
F4006BDM	CD4006BF
F4006BPC	CD4006BE
F4007UBDC	CD4007UBF
F4007UBDM	CD4007UBF
F4007UBPC	CD4007UBE
F4008BDC	CD4008BF
F4008BDM	CD4008BF
F4008BPC	CD4008BE
F4011BDC	CD4011BF
F4011BDM	CD4011BF
F4011BPC	CD4011BE
F4012BDC	CD4012BF
F4012BDM	CD4012BF
F4012BPC	CD4012BE
F4013BDC	CD4013BF
F4013BDM	CD4013BF
F4013BPC	CD4013BE
F4014BDC	CD4014BF
F4014BDM	CD4014BF
F4014BPC	CD4014BE
F4015BDC	CD4015BF
F4015BDM	CD4015BF
F4015BPC	CD4015BE
F4016BDC	CD4016BF
F4016BDM	CD4016BF
F4016BPC	CD4016BE
F4017BDC	CD4017BF
F4017BDM	CD4017BF
F4017BPC	CD4017BE
F4018BDC	CD4018BF
F4018BDM	CD4018BF
F4018BPC	CD4018BE
F4019BDC	CD4019BF
F4019BDM	CD4019BF
F4019BPC	CD4019BE
F4020BDC	CD4020BF
F4020BDM	CD4020BF
F4020BPC	CD4020BE
F4021BDC	CD4021BF

Industry Type	RCA Replacement Type
F4021BDM	CD4021BF
F4021BPC	CD4021BE
F4022BDC	CD4022BF
F4022BDM	CD4022BF
F4022BPC	CD4022BE
F4023BDC	CD4023BF
F4023BDM	CD4023BF
F4023BPC	CD4023BE
F4024BDC	CD4024BF
F4024BDM	CD4024BF
F4024BPC	CD4024BE
F4025BDC	CD4025BF
F4025BDM	CD4025BF
F4025BPC	CD4025BE
F4027BDC	CD4027BF
F4027BDM	CD4027BF
F4027BPC	CD4027BE
F4028BDC	CD4028BF
F4028BDM	CD4028BF
F4028BPC	CD4028BE
F4029BDC	CD4029BF
F4029BDM	CD4029BF
F4029BPC	CD4029BE
F4030BDC	CD4030BF
F4030BDM	CD4030BF
F4030BPC	CD4030BE
F4031BDC	CD4031BF
F4031BDM	CD4031BF
F4031BPC	CD4031BE
F4034BDC	CD4034BF
F4034BDM	CD4034BF
F4034BPC	CD4034BE
F4035BDC	CD4035BF
F4035BDM	CD4035BF
F4035BPC	CD4035BE
F4040BDC	CD4040BF
F4040BDM	CD4040BF
F4040BPC	CD4040BE
F4041BDC	CD4041BF
F4041BDM	CD4041BF
F4041BPC	CD4041BE
F4042BDC	CD4042BF
F4042BDM	CD4042BF
F4042BPC	CD4042BE
F4043BDC	CD4043BF
F4043BDM	CD4043BF
F4043BPC	CD4043BE
F4044BDC	CD4044BF
F4044BDM	CD4044BF
F4044BPC	CD4044BE
F4045BDC	CD4045BF
F4045BDM	CD4045BF
F4045BPC	CD4045BE
F4046BDC	CD4046BF
F4046BDM	CD4046BF

## Cross-Reference Guide

Industry Type	RCA Replacement Type
F4046BPC	CD4046BE
F4047BDC	CD4047BF
F4047BDM	CD4047BF
F4047BPC	CD4047BE
F4049BDC	CD4049UBF
F4049BDM	CD4049UBF
F4049BPC	CD4049UBF
F4050BDC	CD4050BF
F4050BDM	CD4050BF
F4050BPC	CD4050BE
F4051BDC	CD4051BF
F4051BDM	CD4051BF
F4051BPC	CD4051BE
F4052BDC	CD4052BF
F4052BDM	CD4052BF
F4052BPC	CD4052BE
F4053BDC	CD4053BF
F4053BDM	CD4053BF
F4053BPC	CD4053BE
F4066BDC	CD4066BF
F4066BDM	CD4066BF
F4066BPC	CD4066BE
F4067BDC	CD4067BF
F4067BDM	CD4067BF
F4067BPC	CD4067BE
F4068BDC	CD4067BF
F4068BDM	CD4067BF
F4068BPC	CD4067BE
F4069UBDC	CD4069UBF
F4069UBDM	CD4069UBF
F4069UBPC	CD4069UBE
F4070BDC	CD4070BF
F4070BDM	CD4070BF
F4070BPC	CD4070BE
F4071BDC	CD4071BF
F4071BDM	CD4071BF
F4071BPC	CD4071BE
F4072BDC	CD4072BF
F4072BDM	CD4072BF
F4072BPC	CD4072BE
F4073BDC	CD4073BF
F4073BDM	CD4073BF
F4073BPC	CD4073BE
F4075BDC	CD4075BF
F4075BDM	CD4075BF
F4075BPC	CD4075BE
F4076BDC	CD4076BF
F4076BDM	CD4076BF
F4076BPC	CD4076BE
F4077BDC	CD4077BF
F4077BDM	CD4077BF
F4077BPC	CD4077BE
F4078BDC	CD4078BF
F4078BDM	CD4078BF
F4078BPC	CD4078BE

Industry Type	RCA Replacement Type
F4081BDC	CD4081BF
F4081BDM	CD4081BF
F4081BPC	CD4081BE
F4082BDC	CD4082BF
F4082BDM	CD4082BF
F4082BPC	CD4082BE
F4085BDC	CD4085BF
F4085BDM	CD4085BF
F4085BPC	CD4085BE
F4086BDC	CD4086BF
F4086BDM	CD4086BF
F4086BPC	CD4086BE
F4093BDC	CD4093BF
F4093BDM	CD4093BF
F4093BPC	CD4093BE
F4510BDC	CD4510BF
F4510BDM	CD4510BF
F4510BPC	CD4510BE
F4511BDC	CD4511BF
F4511BDM	CD4511BF
F4511BPC	CD4511BE
F4512BDC	CD4512BF
F4512BDM	CD4512BF
F4512BPC	CD4512BE
F4514BDC	CD4514BF
F4514BDM	CD4514BF
F4514BPC	CD4514BE
F4515BDC	CD4515BF
F4515BDM	CD4515BF
F4515BPC	CD4515BE
F4516BDC	CD4516BF
F4516BDM	CD4516BF
F4516BPC	CD4516BE
F4518BDC	CD4518BF
F4518BDM	CD4518BF
F4518BPC	CD4518BE
F4520BDC	CD4520BF
F4520BDM	CD4520BF
F4520BPC	CD4520BE
F4527BDC	CD4527BF
F4527BDM	CD4527BF
F4527BPC	CD4527BE
F4532BDC	CD4532BF
F4532BDM	CD4532BF
F4532BPC	CD4532BE
F4538BDC	CD4538BF
F4538BDM	CD4538BF
F4538BPC	CD4538BE
F4543BDC	CD4543BF
F4543BDM	CD4543BF
F4543BPC	CD4543BE
F4555BDC	CD4555BF
F4555BDM	CD4555BF
F4555BPC	CD4555BE
F4556BDC	CD4556BF

Industry Type	RCA Replacement Type
F4556BDM	CD4556BF
F4556BPC	CD4556BE
F4581BDC	CD40181BF
F4581BDM	CD40181BF
F4581BPC	CD40181BE
F4582BDC	CD40182BF
F4582BDM	CD40182BF
F4582BPC	CD40182BE
F4724BDC	CD4724BF
F4724BDM	CD4724BF
F4724BPC	CD4724BE
F40160BDC	CD40160BF
F40160BDM	CD40160BF
F40160BPC	CD40160BE
F40161BDC	CD40161BF
F40161BDM	CD40161BF
F40161BPC	CD40161BE
F40162BDC	CD40162BF
F40162BDM	CD40162BF
F40162BPC	CD40162BE
F40163BDC	CD40163BF
F40163BDM	CD40163BF
F40163BPC	CD40163BE
F40174BDC	CD40174BF
F40174BDM	CD40174BF
F40174BPC	CD40174BE
F40175BDC	CD40175BF
F40175BDM	CD40175BF
F40175BPC	CD40175BE
F40192BDC	CD40192BF
F40192BDM	CD40192BF
F40192BPC	CD40192BE
F40193BDC	CD40193BF
F40193BDM	CD40193BF
F40193BPC	CD40193BE
HCF4000BD	CD4000BD
HCF4000BE	CD4000BE
HCF4000BF	CD4000BF
HCF4001BD	CD4001BD
HCF4001BE	CD4001BE
HCF4001BF	CD4001BF
HCF4001BE	CD4001BE
HCF4002BD	CD4002BD
HCF4002BF	CD4002BF
HCF4002BE	CD4002BE
HCF4006BD	CD4006BD
HCF4006BF	CD4006BF
HCF4007UBD	CD4007UBD
HCF4007UBE	CD4007UBE
HCF4007UBF	CD4007UBF
HCF4008BD	CD4008BD
HCF4008BE	CD4008BE
HCF4008BF	CD4008BF
HCF4011BD	CD4011BD
HCF4011BE	CD4011BE

## Cross-Reference Guide

Industry Type	RCA Replacement Type
HCF4011BF	CD4011BF
HCF4012BD	CD4012BD
HCF4012BE	CD4012BE
HCF4012BF	CD4012BF
HCF4013BD	CD4013BD
HCF4013BE	CD4013BE
HCF4013BF	CD4013BF
HCF4014BD	CD4014BD
HCF4014BE	CD4014BE
HCF4014BF	CD4014BF
HCF4015BD	CD4015BD
HCF4015BE	CD4015BE
HCF4015BF	CD4015BF
HCF4016BD	CD4016BD
HCF4016BE	CD4016BE
HCF4016BF	CD4016BF
HCF4017BD	CD4017BD
HCF4017BE	CD4017BE
HCF4017BF	CD4017BF
HCF4018BD	CD4018BD
HCF4018BE	CD4018BE
HCF4018BF	CD4018BF
HCF4019BD	CD4019BD
HCF4019BE	CD4019BE
HCF4019BF	CD4019BF
HCF4020BD	CD4020BD
HCF4020BE	CD4020BE
HCF4020BF	CD4020BF
HCF4021BD	CD4021BD
HCF4021BE	CD4021BE
HCF4021BF	CD4021BF
HCF4022BD	CD4022BD
HCF4022BE	CD4022BE
HCF4022BF	CD4022BF
HCF4023BD	CD4023BD
HCF4023BE	CD4023BE
HCF4023BF	CD4023BF
HCF4024BD	CD4024BD
HCF4024BE	CD4024BE
HCF4024BF	CD4024BF
HCF4025BD	CD4025BD
HCF4025BE	CD4025BE
HCF4025BF	CD4025BF
HCF4026BD	CD4026BD
HCF4026BE	CD4026BE
HCF4026BF	CD4026BF
HCF4027BD	CD4027BD
HCF4027BE	CD4027BE
HCF4027BF	CD4027BF
HCF4028BD	CD4028BD
HCF4028BE	CD4028BE
HCF4028BF	CD4028BF
HCF4029BD	CD4029BD
HCF4029BE	CD4029BE
HCF4029BF	CD4029BF

Industry Type	RCA Replacement Type
HCF4030BD	CD4030BD
HCF4030BE	CD4030BE
HCF4030BF	CD4030BF
HCF4031BD	CD4031BD
HCF4031BE	CD4031BE
HCF4031BF	CD4031BF
HCF4032BD	CD4032BD
HCF4032BE	CD4032BE
HCF4032BF	CD4032BF
HCF4033BD	CD4033BD
HCF4033BE	CD4033BE
HCF4033BF	CD4033BF
HCF4034BD	CD4034BD
HCF4034BE	CD4034BE
HCF4034BF	CD4034BF
HCF4035BD	CD4035BD
HCF4035BE	CD4035BE
HCF4035BF	CD4035BF
HCF4040BD	CD4040BD
HCF4040BE	CD4040BE
HCF4040BF	CD4040BF
HCF4041UBD	CD4041UBD
HCF4041UBE	CD4041UBE
HCF4041UBF	CD4041UBF
HCF4042BD	CD4042BD
HCF4042BE	CD4042BE
HCF4042BF	CD4042BF
HCF4043BD	CD4043BD
HCF4043BE	CD4043BE
HCF4043BF	CD4043BF
HCF4044BD	CD4044BD
HCF4044BE	CD4044BE
HCF4044BF	CD4044BF
HCF4045BD	CD4045BD
HCF4045BE	CD4045BE
HCF4045BF	CD4045BF
HCF4046BD	CD4046BD
HCF4046BE	CD4046BE
HCF4046BF	CD4046BF
HCF4047BD	CD4047BD
HCF4047BE	CD4047BE
HCF4047BF	CD4047BF
HCF4048BD	CD4048BD
HCF4048BE	CD4048BE
HCF4048BF	CD4048BF
HCF4049UBD	CD4049UBD
HCF4049UBE	CD4049UBE
HCF4049UBF	CD4049UBF
HCF4050BD	CD4050BD
HCF4050BE	CD4050BE
HCF4050BF	CD4050BF
HCF4051BD	CD4051BD
HCF4051BE	CD4051BE
HCF4051BF	CD4051BF
HCF4052BD	CD4052BD

Industry Type	RCA Replacement Type
HCF4052BE	CD4052BE
HCF4052BF	CD4052BF
HCF4053BD	CD4053BD
HCF4053BE	CD4053BE
HCF4053BF	CD4053BF
HCF4054BD	CD4054BD
HCF4054BE	CD4054BE
HCF4054BF	CD4054BF
HCF4055BD	CD4055BD
HCF4055BE	CD4055BE
HCF4055BF	CD4055BF
HCF4056BD	CD4056BD
HCF4056BE	CD4056BE
HCF4056BF	CD4056BF
HCF4060BD	CD4060BD
HCF4060BE	CD4060BE
HCF4060BF	CD4060BF
HCF4063BD	CD4063BD
HCF4063BE	CD4063BE
HCF4063BF	CD4063BF
HCF4066BD	CD4066BD
HCF4066BE	CD4066BE
HCF4066BF	CD4066BF
HCF4067BD	CD4067BD
HCF4067BE	CD4067BE
HCF4067BF	CD4067BF
HCF4068BD	CD4068BD
HCF4068BE	CD4068BE
HCF4068BF	CD4068BF
HCF4069UBD	CD4069UBD
HCF4069UBE	CD4069UBE
HCF4069UBF	CD4069UBF
HCF4070BD	CD4070BD
HCF4070BE	CD4070BE
HCF4070BF	CD4070BF
HCF4071BD	CD4071BD
HCF4071BE	CD4071BE
HCF4071BF	CD4071BF
HCF4072BD	CD4072BD
HCF4072BE	CD4072BE
HCF4072BF	CD4072BF
HCF4073BD	CD4073BD
HCF4073BE	CD4073BE
HCF4073BF	CD4073BF
HCF4075BD	CD4075BD
HCF4075BE	CD4075BE
HCF4075BF	CD4075BF
HCF4076BD	CD4076BD
HCF4076BE	CD4076BE
HCF4076BF	CD4076BF
HCF4077BD	CD4077BD
HCF4077BE	CD4077BE
HCF4077BF	CD4077BF
HCF4078BD	CD4078BD
HCF4078BE	CD4078BE

## Cross-Reference Guide

Industry Type	RCA Replacement Type
HCF4078BF	CD4078BF
HCF4081BD	CD4081BD
HCF4081BE	CD4081BE
HCF4081BF	CD4081BF
HCF4082BD	CD4082BD
HCF4082BE	CD4082BE
HCF4082BF	CD4082BF
HCF4085BD	CD4085BD
HCF4085BE	CD4085BE
HCF4085BF	CD4085BF
HCF4086BD	CD4086BD
HCF4086BE	CD4086BE
HCF4086BF	CD4086BF
HCF4089BD	CD4089BD
HCF4089BE	CD4089BE
HCF4089BF	CD4089BF
HCF4093BD	CD4093BD
HCF4093BE	CD4093BE
HCF4093BF	CD4093BF
HCF4094BD	CD4094BD
HCF4094BE	CD4094BE
HCF4094BF	CD4094BF
HCF4095BD	CD4095BD
HCF4095BE	CD4095BE
HCF4095BF	CD4095BF
HCF4096BD	CD4096BD
HCF4096BE	CD4096BE
HCF4096BF	CD4096BF
HCF4097BD	CD4097BD
HCF4097BE	CD4097BE
HCF4097BF	CD4097BF
HCF4098BD	CD4098BD
HCF4098BE	CD4098BE
HCF4098BF	CD4098BF
HCF4099BD	CD4099BD
HCF4099BE	CD4099BE
HCF4099BF	CD4099BF
HCF4502BD	CD4502BD
HCF4502BE	CD4502BE
HCF4502BF	CD4502BF
HCF4508BD	CD4508BD
HCF4508BE	CD4508BE
HCF4508BF	CD4508BF
HCF4510BD	CD4510BD
HCF4510BE	CD4510BE
HCF4510BF	CD4510BF
HCF4511BD	CD4511BD
HCF4511BE	CD4511BE
HCF4511BF	CD4511BF
HCF4512BD	CD4512BD
HCF4512BE	CD4512BE
HCF4512BF	CD4512BF
HCF4514BD	CD4514BD
HCF4514BE	CD4514BE
HCF4514BF	CD4514BF

Industry Type	RCA Replacement Type
HCF4515BD	CD4515BD
HCF4515BE	CD4515BE
HCF4515BF	CD4515BF
HCF4516BD	CD4516BD
HCF4516BE	CD4516BE
HCF4516BF	CD4516BF
HCF4518BD	CD4518BD
HCF4518BE	CD4518BE
HCF4518BF	CD4518BF
HCF4520BD	CD4520BD
HCF4520BE	CD4520BE
HCF4520BF	CD4520BF
HCF4527BD	CD4527BD
HCF4527BE	CD4527BE
HCF4527BF	CD4527BF
HCF4532BD	CD4532BD
HCF4532BE	CD4532BE
HCF4532BF	CD4532BF
HCF4555BD	CD4555BD
HCF4555BE	CD4555BE
HCF4555BF	CD4555BF
HCF4556BD	CD4556BD
HCF4556BE	CD4556BE
HCF4556BF	CD4556BF
HD14503B	CD4503BE
HD14541B	CD4541BE
HD174C04	CD4096BD
HD174C14	CD40106BD
HD174C86	CD40308D
HD174C86	CD4070BD
HD374C04	CD4069BE
HD374C14	CD40106BE
HD374C160	CD40160BE
HD374C161	CD40161BE
HD374C162	CD40162BE
HD374C163	CD40163BE
HD374C164	CD4015BE
HD374C165	CD4021BE
HD374C173	CD4076BE
HD374C174	CD40174BE
HD374C192	CD40192BE
HD374C193	CD40193BE
HEF4000B	CD4000BE
HEF4000BD	CD4000BE
HEF4001B	CD4001BE
HEF4001UB	CD4001UBE
HEF4002B	CD4002BE
HEF4006B	CD4006BE
HEF4007UB	CD4007UBE
HEF4008B	CD4008BE
HEF4011B	CD4011BE
HEF4011UB	CD4011UBE
HEF4012B	CD4012BE
HEF4013B	CD4013BE
HEF4014B	CD4014BE

Industry Type	RCA Replacement Type
HEF4015B	CD4015BE
HEF4016B	CD4016BE
HEF4017B	CD4017BE
HEF4018B	CD4018BE
HEF4019B	CD4019BE
HEF4020B	CD4020BE
HEF4021B	CD4021BE
HEF4022B	CD4022BE
HEF4023B	CD4023BE
HEF4024B	CD4024BE
HEF4025B	CD4025BE
HEF4027B	CD4027BE
HEF4028B	CD4028BE
HEF4029B	CD4029BE
HEF4030B	CD4030BE
HEF4031B	CD4031BE
HEF4035B	CD4035BE
HEF4040B	CD4040BE
HEF4041B	CD4041BE
HEF4042B	CD4042BE
HEF4043B	CD4043BE
HEF4044B	CD4044BE
HEF4046B	CD4046BE
HEF4047B	CD4047BE
HEF4049B	CD4049UBE
HEF4050B	CD4050BE
HEF4051B	CD4051BE
HEF4052B	CD4052BE
HEF4053B	CD4053BE
HEF4059B	CD4059BE
HEF4060B	CD4060BE
HEF4066B	CD4066BE
HEF4067B	CD4067BE
HEF4068B	CD4068BE
HEF4069UB	CD4069UBE
HEF4070B	CD4070BE
HEF4071B	CD4071BE
HEF4072B	CD4072BE
HEF4073B	CD4073BE
HEF4075B	CD4075BE
HEF4076B	CD4076BE
HEF4077B	CD4077BE
HEF4078B	CD4078BE
HEF4081B	CD4081BE
HEF4082B	CD4082BE
HEF4085B	CD4085BE
HEF4086B	CD4086BE
HEF4093B	CD4093BE
HEF4094B	CD4094BE
HEF4502B	CD4502BE
HEF4508B	CD4508BE
HEF4510B	CD4510BE
HEF4511B	CD4511BE
HEF4512B	CD4512BE
HEF4514B	CD4514BE

## Cross-Reference Guide

Industry Type	RCA Replacement Type
HEF4515B	CD4515BE
HEF4516B	CD4516BE
HEF4517B	CD4517BE
HEF4518B	CD4518BE
HEF4520B	CD4520BE
HEF4527B	CD4527BE
HEF4532B	CD4532BE
HEF4538B	CD4538BE
HEF4541B	CD4541BE
HEF4543B	CD4543BE
HEF4555B	CD4555BE
HEF4556B	CD4556BE
HEF4585B	CD4585BE
HEF4724B	CD4724BE
HEF40160B	CD40160BE
HEF40161B	CD40161BE
HEF40162B	CD40162BE
HEF40163B	CD40163BE
HEF40174B	CD40174BE
HEF40175B	CD40175BE
HEF40192B	CD40192BE
HEF40193B	CD40193BE
HEF40194B	CD40194BE
MC14000BAL	CD4000BF
MC14000BCL	CD4000BF
MC14000BCP	CD4000BE
MC14000UBAL	CD4000UBF
MC14000UBCL	CD4000UBF
MC14000UBCP	CD4000UBE
MC14001BAL	CD4001BF
MC14001BCL	CD4001BF
MC14001BCP	CD4001BE
MC14001UBAL	CD4001UBF
MC14001UBCL	CD4001UBF
MC14001UBCP	CD4001UBE
MC14002BAL	CD4002BF
MC14002BCL	CD4002BF
MC14002BCP	CD4002BE
MC14002UBAL	CD4002UBF
MC14002UBCL	CD4002UBF
MC14002UBCP	CD4002UBE
MC14006BAL	CD4006BF
MC14006BCL	CD4006BF
MC14006BCP	CD4006BE
MC14007BCL	CD4007UBF
MC14007UBAL	CD4007UBF
MC14007UBCL	CD4007UBF
MC14007UBCP	CD4007UBE
MC14008BAL	CD4008BF
MC14008BCL	CD4008BF
MC14008BCP	CD4008BE
MC14009UBAL	CD4009UBF
MC14009UBCL	CD4009UBF
MC14009UBCP	CD4009UBE
MC14010BAL	CD4010BF

Industry Type	RCA Replacement Type
MC14010BCP	CD4010BE
MC14011BAL	CD4011BF
MC14011BCL	CD4011BF
MC14011BCP	CD4011BE
MC14011UBAL	CD4011UBF
MC14011UBCL	CD4011UBF
MC14011UBCP	CD4011UBE
MC14012BAL	CD4012BF
MC14012BCL	CD4012BF
MC14012BCP	CD4012BE
MC14012UBAL	CD4012UBF
MC14012UBCL	CD4012UBF
MC14012UBCP	CD4012UBE
MC14013BAL	CD4013BF
MC14013BCL	CD4013BF
MC14013BCP	CD4013BE
MC14014BAL	CD4014BF
MC14014BCL	CD4014BF
MC14014BCP	CD4014BE
MC14015BAL	CD4015BF
MC14015BCL	CD4015BF
MC14015BCP	CD4015BE
MC14016BAL	CD4016BF
MC14016BCL	CD4016BF
MC14016BCP	CD4016BE
MC14017BAL	CD4017BF
MC14017BCL	CD4017BF
MC14017BCP	CD4017BE
MC14018BAL	CD4018BF
MC14018BCL	CD4018BF
MC14018BCP	CD4018BE
MC14019BAL	CD4019BF
MC14019BCL	CD4019BF
MC14019BCP	CD4019BE
MC14020BAL	CD4020BF
MC14020BCL	CD4020BF
MC14020BCP	CD4020BE
MC14021BAL	CD4021BF
MC14021BCL	CD4021BF
MC14021BCP	CD4021BE
MC14022BAL	CD4022BF
MC14022BCL	CD4022BF
MC14022BCP	CD4022BE
MC14023BAL	CD4023BF
MC14023BCL	CD4023BF
MC14023BCP	CD4023BE
MC14023UBAL	CD4023UBF
MC14023UBCL	CD4023UBF
MC14023UBCP	CD4023UBE
MC14024BAL	CD4024BF
MC14024BCL	CD4024BF
MC14024BCP	CD4024BE
MC14025BAL	CD4025BF
MC14025BCL	CD4025UBF
MC14025BCP	CD4025BE

Industry Type	RCA Replacement Type
MC14025UBAL	CD4025UBF
MC14025UBCL	CD4025UBF
MC14025UBCP	CD4025UBE
MC14027BAL	CD4027BF
MC14027BCL	CD4027BF
MC14027BCP	CD4027BE
MC14028BAL	CD4028BF
MC14028BCL	CD4028BF
MC14028BCP	CD4028BE
MC14029BAL	CD4029BF
MC14029BCL	CD4029BF
MC14029BCP	CD4029BE
MC14032BAL	CD4032BF
MC14032BCL	CD4032BF
MC14032BCP	CD4032BE
MC14034BAL	CD4034BF
MC14034BCL	CD4034BF
MC14034BCP	CD4034BE
MC14035BAL	CD4035BF
MC14035BCL	CD4035BF
MC14035BCP	CD4035BE
MC14038BAL	CD4038BF
MC14038BCL	CD4038BF
MC14038BCP	CD4038BE
MC14040BAL	CD4040BF
MC14040BCL	CD4040BF
MC14040BCP	CD4040BE
MC14042BAL	CD4042BF
MC14042BCL	CD4042BF
MC14042BCP	CD4042BE
MC14043BAL	CD4043BF
MC14043BCL	CD4043BF
MC14043BCP	CD4043BE
MC14044BAL	CD4044BF
MC14044BCL	CD4044BF
MC14044BCP	CD4044BE
MC14046BAL	CD4046BF
MC14046BCL	CD4046BF
MC14046BCP	CD4046BE
MC14049UBAL	CD4049UBF
MC14049UBCL	CD4049UBF
MC14049UBCP	CD4049UBE
MC14050BAL	CD4050BF
MC14050BCL	CD4050BF
MC14050BCP	CD4050BE
MC14051BAL	CD4051BF
MC14051BCL	CD4051BF
MC14051BCP	CD4051BE
MC14052BAL	CD4052BF
MC14052BCL	CD4052BF
MC14052BCP	CD4052BE
MC14053BAL	CD4053BF
MC14053BCP	CD4053BE
MC14053BCP	CD4053BE
MC14060BAL	CD4060BF

## Cross-Reference Guide

Industry Type	RCA Replacement Type
MC14060BCL	CD4060BF
MC14060BCP	CD4060BE
MC14066BAL	CD4066BF
MC14066BCL	CD4066BF
MC14066BCP	CD4066BE
MC14068BAL	CD4068BF
MC14068BCL	CD4068BF
MC14068BCP	CD4068BE
MC14069UBAL	CD4069UBF
MC14069UBCL	CD4069UBF
MC14069UBCP	CD4069UBE
MC14070BAL	CD4070BF
MC14070BCL	CD4070BF
MC14070BCP	CD4070BE
MC14071BAL	CD4071BF
MC14071BCL	CD4071BF
MC14071BCP	CD4071BE
MC14072BAL	CD4072BF
MC14072BCL	CD4072BF
MC14072BCP	CD4072BE
MC14073BAL	CD4073BF
MC14073BCL	CD4073BF
MC14073BCP	CD4073BE
MC14075BAL	CD4075BF
MC14075BCL	CD4075BF
MC14075BCP	CD4075BE
MC14076BAL	CD4076BF
MC14076BCL	CD4076BF
MC14076BCP	CD4076BE
MC14077BAL	CD4077BF
MC14077BCL	CD4077BF
MC14077BCP	CD4077BE
MC14078BAL	CD4078BF
MC14078BCL	CD4078BF
MC14078BCP	CD4078BE
MC14081BAL	CD4081BF
MC14081BCL	CD4081BF
MC14081BCP	CD4081BE
MC14082BAL	CD4082BF
MC14082BCL	CD4082BF
MC14082BCP	CD4082BE
MC14093BAL	CD4093BF
MC14093BCL	CD4093BF
MC14093BCP	CD4093BE
MC14094BAL	CD4094BF
MC14094BCL	CD4094BF
MC14094BCP	CD4094BE
MC14099BAL	CD4099BF
MC14099BCL	CD4099BF
MC14099BCP	CD4099BE
MC14160BAL	CD40160BF
MC14160BCL	CD40160BF
MC14160BCP	CD40160BE
MC14161BAL	CD40161BF
MC14161BCL	CD40161BF

Industry Type	RCA Replacement Type
MC14161BCP	CD40161BE
MC14162BAL	CD40162BF
MC14162BCL	CD40162BF
MC14163BAL	CD40163BF
MC14163BCL	CD40163BF
MC14163BCP	CD40163BE
MC14174BAL	CD40174BF
MC14174BCL	CD40174BF
MC14174BCP	CD40174BE
MC14175BAL	CD40175BF
MC14175BCL	CD40175BF
MC14175BCP	CD40175BE
MC14181BAL	CD40181BF
MC14181BCL	CD40181BF
MC14181BCP	CD40181BE
MC14182BAL	CD40182BF
MC14182BCL	CD40182BF
MC14182BCP	CD40182BE
MC14194BAL	CD40194BF
MC14194BCL	CD40194BF
MC14194BCP	CD40194BE
MC14413L	CD22413F
MC14413P	CD22413E
MC14414L	CD22414F
MC14414P	CD22414E
MC14502BAL	CD4502BD
MC14502BCL	CD4502BF
MC14502BCP	CD4502BE
MC14503BAL	CD4503BF
MC14503BCL	CD4503BF
MC14504BAL	CD40109BF
MC14504BCL	CD4504BF
MC14504BCP	CD40109BE
MC14508BAL	CD4508BF
MC14508BCL	CD4508BF
MC14508BCP	CD4508BE
MC14510BAL	CD4510BF
MC14510BCL	CD4510BF
MC14510BCP	CD4510BE
MC14511BAL	CD4511BF
MC14511BCL	CD4511BF
MC14511BCP	CD4511BE
MC14511BMJ	CD4511BF
MC14512BAL	CD4512BF
MC14512BCL	CD4512BF
MC14512BCP	CD4512BE
MC14514BAL	CD4514BF
MC14514BCL	CD4514BF
MC14514BCP	CD4514BE
MC14515BAL	CD4515BF
MC14515BCP	CD4515BE
MC14516BAL	CD4516BF
MC14516BCL	CD4516BF
MC14516BCP	CD4516BE
MC14517BAL	CD4517BF

Industry Type	RCA Replacement Type
MC14517BCL	CD4517BF
MC14517BCP	CD4517BE
MC14518BAL	CD4518BF
MC14518BCL	CD4518BF
MC14518BCP	CD4518BE
MC14520BAL	CD4520BF
MC14520BCL	CD4520BF
MC14520BCP	CD4520BE
MC14527BAL	CD4527BF
MC14527BCL	CD4527BF
MC14527BCP	CD4527BE
MC14532BAL	CD4532BF
MC14532BCL	CD4532BF
MC14532BCP	CD4532BE
MC14536BAL	CD4536BF
MC14536BCL	CD4536BF
MC14536BCP	CD4536BE
MC14538BAL	CD4538BF
MC14538BCL	CD4538BF
MC14538BCP	CD4538BE
MC14541BAL	CD4541BF
MC14541BCL	CD4541BF
MC14541BCP	CD4541BE
MC14543BAL	CD4543BF
MC14543BCL	CD4543BF
MC14543BCP	CD4543BE
MC14555BAL	CD4555BF
MC14555BCL	CD4555BF
MC14555BCP	CD4555BE
MC14556BAL	CD4556BF
MC14556BCL	CD4556BF
MC14556BCP	CD4556BE
MC14581BAL	CD40181BF
MC14581BCL	CD40181BF
MC14581BCP	CD40181BE
MC14582BAL	CD40182BF
MC14582BCL	CD40182BF
MC14582BCP	CD40182BE
MC14584BAL	CD40106BF
MC14584BCL	CD40106BF
MC14584BCP	CD40106BE
MC14585BAL	CD4585BF
MC14585BCL	CD4585BF
MC14585BCP	CD4585BE
MC15000UBAL	CD4000UBF
MC15162BCP	CD40162BE
MC15403BCP	CD4503BE
MC3419	CD22419
MM54C04D	CD4069BF
MM54C160D	CD40160BF
MM54C161D	CD40161BF
MM54C162D	CD40162BF
MM54C163D	CD40163BF
MM54C173D	CD4076BF
MM54C174D	CD40174BF



## Cross-Reference Guide

Industry Type	RCA Replacement Type
MM74C04N	CD4068BE
MM74C160N	CD40160BE
MM74C161N	CD40161BE
MM74C162N	CD40162BE
MM74C163N	CD40163BE
MM74C164N	CD4015BE
MM74C165N	CD4021BE
MM74C173N	CD4076BE
MM74C174N	CD40174BE
MSM4036	CD4036A
MSM4039	CD4039A
MSM4061	CD4061
MSM4061A	CD4061A
S2859P	CD22859E
SCL4000BC	CD4000BF
SCL4000BD	CD4000BD
SCL4001BC	CD4001BF
SCL4001BD	CD4001BD
SCL4001BE	CD4001BE
SCL4001UBC	CD4001UBF
SCL4001UBD	CD4001UBD
SCL4001UBE	CD4001UBE
SCL4002BC	CD4002BF
SCL4002BD	CD4002BD
SCL4002BE	CD4002BE
SCL4006ABC	CD4006BF
SCL4006ABD	CD4006BD
SCL4006ABE	CD4006BE
SCL4006BC	CD4006BF
SCL4006BD	CD4006BD
SCL4006BE	CD4006BE
SCL4007UBC	CD4007UBF
SCL4007UBD	CD4007UBD
SCL4007UBE	CD4007UBE
SCL4008BC	CD4008BF
SCL4008BD	CD4008BD
SCL4008BE	CD4008BE
SCL4009UBC	CD4009UBF
SCL4009UBD	CD4009UBD
SCL4009UBE	CD4009UBE
SCL4010BC	CD4010BF
SCL4010BD	CD4010BD
SCL4010BE	CD4010BE
SCL4011BC	CD4011BF
SCL4011BD	CD4011BD
SCL4011BE	CD4011BE
SCL4011UBC	CD4011UBF
SCL4011UBD	CD4011UBD
SCL4011UBE	CD4011UBE
SCL4012BC	CD4012BF
SCL4012BD	CD4012BD
SCL4012BE	CD4012BE
SCL4013BC	CD4013BF
SCL4013BD	CD4013BD
SCL4013BE	CD4013BE

Industry Type	RCA Replacement Type
SCL4014BC	CD4014BF
SCL4014BD	CD4014BD
SCL4014BE	CD4014BE
SCL4015BC	CD4015BF
SCL4015BD	CD4015BD
SCL4015BE	CD4015BE
SCL4016BC	CD4016BF
SCL4016BD	CD4016BD
SCL4016BE	CD4016BE
SCL4017BC	CD4017BF
SCL4017BD	CD4017BD
SCL4017BE	CD4017BE
SCL4018BC	CD4018BF
SCL4018BD	CD4018BD
SCL4018BE	CD4018BE
SCL4019BC	CD4019BF
SCL4019BD	CD4019BD
SCL4019BE	CD4019BE
SCL4020ABC	CD4020BF
SCL4020ABD	CD4020BD
SCL4020ABE	CD4020BE
SCL4020BC	CD4020BF
SCL4020BD	CD4020BD
SCL4020BE	CD4020BE
SCL4021BC	CD4021BF
SCL4021BD	CD4021BD
SCL4021BE	CD4021BE
SCL4022ABC	CD4022BF
SCL4022ABD	CD4022BD
SCL4022ABE	CD4022BE
SCL4022BC	CD4022BF
SCL4022BD	CD4022BD
SCL4022BE	CD4022BE
SCL4023BC	CD4023BF
SCL4023BD	CD4023BD
SCL4023BE	CD4023BE
SCL4024BC	CD4024BF
SCL4024BD	CD4024BD
SCL4024BE	CD4024BE
SCL4025BC	CD4025BF
SCL4025BD	CD4025BD
SCL4025BE	CD4025BE
SCL4026ABC	CD4026BF
SCL4026ABD	CD4026BD
SCL4026ABE	CD4026BE
SCL4027BC	CD4027BF
SCL4027BD	CD4027BD
SCL4027BE	CD4027BE
SCL4028BC	CD4028BF
SCL4028BD	CD4028BD
SCL4028BE	CD4028BE
SCL4029BC	CD4029BF
SCL4029BD	CD4029BD
SCL4029BE	CD4029BE
SCL4030BC	CD4030BF

Industry Type	RCA Replacement Type
SCL4030BD	CD4030BD
SCL4030BE	CD4030BE
SCL4033ABC	CD4033BF
SCL4033ABD	CD4033BD
SCL4034ABC	CD4034BF
SCL4034ABD	CD4034BD
SCL4034ABE	CD4034BE
SCL4034BC	CD4034BF
SCL4035BC	CD4035BF
SCL4035BD	CD4035BD
SCL4035BE	CD4035BE
SCL4040ABC	CD4040BF
SCL4040ABD	CD4040BD
SCL4040ABE	CD4040BE
SCL4040BC	CD4040BF
SCL4040BD	CD4040BD
SCL4040BE	CD4040BE
SCL4041UBC	CD4041UBF
SCL4041UBD	CD4041UBD
SCL4041UBE	CD4041UBE
SCL4042BC	CD4042BF
SCL4042BD	CD4042BD
SCL4042BE	CD4042BE
SCL4043ABC	CD4043BF
SCL4043ABD	CD4043BD
SCL4043ABE	CD4043BE
SCL4043BC	CD4043BF
SCL4043BD	CD4043BD
SCL4043BE	CD4043BE
SCL4044ABC	CD4044BF
SCL4044ABD	CD4044BD
SCL4044ABE	CD4044BE
SCL4044BC	CD4044BF
SCL4044BD	CD4044BD
SCL4044BE	CD4044BE
SCL4046BC	CD4046BF
SCL4046BD	CD4046BD
SCL4046BE	CD4046BE
SCL4047BC	CD4047BF
SCL4047BD	CD4047BD
SCL4047BE	CD4047BE
SCL4049UBC	CD4049UBF
SCL4049UBD	CD4049UBD
SCL4049UBE	CD4049UBE
SCL4050BC	CD4050BF
SCL4050BD	CD4050BD
SCL4050BE	CD4050BE
SCL4051BC	CD4051BF
SCL4051BD	CD4051BD
SCL4051BE	CD4051BE
SCL4052BC	CD4052BF
SCL4052BD	CD4052BD
SCL4052BE	CD4052BE
SCL4053BC	CD4053BF
SCL4053BD	CD4053BD

## Cross-Reference Guide

Industry Type	RCA Replacement Type
SCL4053BE	CD4053BE
SCL4060ABC	CD4060BF
SCL4060ABD	CD4060BD
SCL4060ABE	CD4060BE
SCL4060BC	CD4060BF
SCL4060BD	CD4060BD
SCL4060BE	CD4060BE
SCL4066BC	CD4066BF
SCL4066BD	CD4066BD
SCL4066BE	CD4066BE
SCL4068BC	CD4068BF
SCL4068BD	CD4068BD
SCL4068BE	CD4068BE
SCL4069UBC	CD4069UBF
SCL4069UBD	CD4069UBD
SCL4069UBE	CD4069UBE
SCL4070BC	CD4070BF
SCL4070BD	CD4070BD
SCL4070BE	CD4070BE
SCL4071BC	CD4071BF
SCL4071BD	CD4071BD
SCL4071BE	CD4071BE
SCL4072BC	CD4072BF
SCL4072BD	CD4072BD
SCL4072BE	CD4072BE
SCL4073BC	CD4073BF
SCL4073BD	CD4073BD
SCL4073BE	CD4073BE
SCL4075BC	CD4075BF
SCL4075BD	CD4075BD
SCL4075BE	CD4075BE
SCL4076BC	CD4076BF
SCL4076BD	CD4076BD
SCL4076BE	CD4076BE
SCL4077BC	CD4077BF
SCL4077BD	CD4077BD
SCL4077BE	CD4077BE
SCL4078BC	CD4078BF
SCL4078BD	CD4078BD
SCL4078BE	CD4078BE
SCL4081BC	CD4081BF
SCL4081BD	CD4081BD
SCL4081BE	CD4081BE
SCL4082BC	CD4082BF
SCL4082BD	CD4082BD
SCL4082BE	CD4082BE
SCL4085BC	CD4085BF
SCL4085BD	CD4085BD
SCL4085BE	CD4085BE
SCL4086BC	CD4086BF
SCL4086BD	CD4086BD
SCL4086BE	CD4086BE
SCL4093BC	CD4093BF
SCL4093BD	CD4093BD
SCL4093BE	CD4093BE

Industry Type	RCA Replacement Type
SCL4094BC	CD4094BF
SCL4094BD	CD4094BD
SCL4094BE	CD4094BE
SCL4099BC	CD4099BF
SCL4099BD	CD4099BD
SCL4099BE	CD4099BE
SCL4160BC	CD40160BF
SCL4160BD	CD40160BD
SCL4160BE	CD40160BE
SCL4161BC	CD40161BF
SCL4161BD	CD40161BD
SCL4161BE	CD40161BE
SCL4162BC	CD40162BF
SCL4162BD	CD40162BD
SCL4162BE	CD40162BE
SCL4163BC	CD40163BF
SCL4163BD	CD40163BD
SCL4163BE	CD40163BE
SCL4174BC	CD40174BF
SCL4174BD	CD40174BD
SCL4174BE	CD40174BE
SCL4502BC	CD4502BF
SCL4502BD	CD4502BD
SCL4502BE	CD4502BE
SCL4508BC	CD4508BF
SCL4508BD	CD4508BD
SCL4508BE	CD4508BE
SCL4510BC	CD4510BF
SCL4510BD	CD4510BD
SCL4510BE	CD4510BE
SCL4511BC	CD4511BF
SCL4511BD	CD4511BD
SCL4511BE	CD4511BE
SCL4512BC	CD4512BF
SCL4512BD	CD4512BD
SCL4512BE	CD4512BE
SCL4514BC	CD4514BF
SCL4514BD	CD4514BD
SCL4514BE	CD4514BE
SCL4515BC	CD4515BF
SCL4515BD	CD4515BD
SCL4515BE	CD4515BE
SCL4516BC	CD4516BF
SCL4516BD	CD4516BD
SCL4516BE	CD4516BE
SCL4517BC	CD4517BF
SCL4517BD	CD4517BD
SCL4517BE	CD4517BE
SCL4518BC	CD4518BF
SCL4518BD	CD4518BD
SCL4518BE	CD4518BE
SCL4520BC	CD4520BF
SCL4520BD	CD4520BD
SCL4520BE	CD4520BE
SCL4527BC	CD4527BD

Industry Type	RCA Replacement Type
SCL4527BD	CD4527BF
SCL4527BE	CD4527BE
SCL4528BC	CD4528BF
SCL4528BD	CD4528BD
SCL4528BE	CD4528BF
SCL4532BC	CD4532BF
SCL4532BD	CD4532BD
SCL4532BE	CD4532BE
SCL4543BC	CD4543BF
SCL4543BD	CD4543BD
SCL4543BE	CD4543BE
SCL4555BC	CD4555BF
SCL4555BD	CD4555BD
SCL4555BE	CD4555BE
SCL4556BC	CD4556BF
SCL4556BD	CD4556BD
SCL4556BE	CD4556BE
SCL4581BC	CD40181BF
SCL4581BD	CD40181BD
SCL4581BE	CD40181BE
SCL4582BC	CD40182BF
SCL4582BD	CD40182BD
SCL4582BE	CD40182BE
SCL4584BC	CD40106BF
SCL4584BD	CD40106BD
SCL4584BE	CD40106BE
SCL4585BC	CD4585BF
SCL4585BD	CD4585BD
SCL4585BE	CD4585BE
TC4001BP	CD4001BE
TC4001UBP	CD4001UBE
TC4002BP	CD4002BE
TC4006BP	CD4006BE
TC4007UBP	CD4007UBE
TC4008BP	CD4008BE
TC4009UBP	CD4009UBE
TC4010BP	CD4010BE
TC4011BP	CD4011BE
TC4011UBP	CD4011UBE
TC4012BP	CD4012BE
TC4013BP	CD4013BE
TC4014BP	CD4014BE
TC4015BP	CD4015BE
TC4016BP	CD4016BE
TC4017BP	CD4017BE
TC4018BP	CD4018BE
TC4019BP	CD4019BE
TC4020BP	CD4020BE
TC4021BP	CD4021BE
TC4022BP	CD4022BE
TC4023BP	CD4023BE
TC4024BP	CD4024BE
TC4025BP	CD4025BE
TC4027BP	CD4027BE
TC4028BP	CD4028BE

## Cross-Reference Guide

Industry Type	RCA Replacement Type
TC4029BP	CD4029BE
TC4030BP	CD4030BE
TC4032BP	CD4032BE
TC4034BP	CD4034BE
TC4035BP	CD4035BE
TC4036B	CD4036A
TC4038BP	CD4038BE
TC4039B	CD4039A
TC4040BP	CD4040BE
TC4042BP	CD4042BE
TC4043BP	CD4043BE
TC4044BP	CD4044BE
TC4047BP	CD4047BE
TC4049BP	CD4049UBE
TC4050BP	CD4050BE
TC4051BP	CD4051BE
TC4052BP	CD4052BE
TC4053BP	CD4053BE
TC4054BP	CD4054BE
TC4055BP	CD4055BE
TC4056BP	CD4056BE
TC4061	CD4061A
TC4063BP	CD4063BE
TC4066BP	CD4066BE
TC4068BP	CD4068BE
TC4069BP	CD4069UBE
TC4071BP	CD4071BE
TC4072BP	CD4072BE
TC4073BP	CD4073BE
TC4075BP	CD4075BE
TC4076BP	CD4076BE
TC4078BP	CD4078BE
TC4081BP	CD4081BE
TC4082BP	CD4082BE
TC4083BP	CD4083BE
TC4085BP	CD4085BE
TC4086BP	CD4086BE
TC4093BP	CD4093BE
TC4094BP	CD4094BE
TC40160BP	CD40160BE
TC40161BP	CD40161BE
TC40162BP	CD40162BE
TC40163BP	CD40163BE
TC40174BP	CD40174BE
TC40175BP	CD40175BE
TC40192BP	CD40192BE
TC40193BP	CD40193BE
TC4508BP	CD4508BE
TC4510BP	CD4510BE
TC4511BP	CD4511BE
TC4512BP	CD4512BE
TC4514BP	CD4514BE
TC4515BP	CD4515BE
TC4516BP	CD4516BE
TC4518BP	CD4518BE

Industry Type	RCA Replacement Type
TC4520BP	CD4520BE
TC4527BP	CD4527BE
TC4532BP	CD4532BE
TC4543BP	CD4543BE
TC4544BP	CD4555BE
TC4556BP	CD4556BE
TC4585BP	CD4585BE
TP4000AN	CD4000AE
TP4001AN	CD4001AE
TP4001AN	CD4002AE
TP4001BN	CD4001BE
TP4007AN	CD4007AE
TP4007UBN	CD4007UBE
TP4008BN	CD4008BE
TP4009AN	CD4009AE
TP4009UBN	CD4009UBE
TP4010AN	CD4010AE
TP4010BN	CD4010BE
TP4011AN	CD4011AE
TP4011BN	CD4011BE
TP4012AN	CD4012AE
TP4013AN	CD4013AE
TP4013BN	CD4013BE
TP4014AN	CD4014AE
TP4015AN	CD4015AE
TP4015BN	CD4015BE
TP4016AN	CD4016AE
TP4016UBN	CD4016BE
TP4017AN	CD4017AE
TP4018AN	CD4018AE
TP4018BN	CD4018BE
TP4019AN	CD4019AE
TP4019BN	CD4019BE
TP4020AN	CD4020AE
TP4020BN	CD4020BE
TP4021AN	CD4021AE
TP4022AN	CD4022AE
TP4023AN	CD4023AE
TP4024AN	CD4024AE
TP4024BN	CD4024BE
TP4025AN	CD4025AE
TP4027AN	CD4027AE
TP4027BN	CD4027BE
TP4028AN	CD4028AE
TP4028BN	CD4028BE
TP4029AN	CD4029AE
TP4030AN	CD4030AE
TP4030BN	CD4030BE
TP4035BN	CD4035BE
TP4040AN	CD4040AE
TP4040BN	CD4040BE
TP4042AN	CD4042AE
TP4042BN	CD4042BE
TP4043AN	CD4043AN
TP4043BN	CD4043BE

Industry Type	RCA Replacement Type
TP4044AN	CD4044AE
TP4044BN	CD4044BE
TP4049AN	CD4049AE
TP4049UBN	CD4049UBE
TP4050AN	CD4050AE
TP4050BN	CD4050BE
TP4051AN	CD4051AE
TP4051BN	CD4051BE
TP4052AN	CD4052AE
TP4052BN	CD4052BE
TP4053AN	CD4053AE
TP4053BN	CD4053BE
TP4066AN	CD4066AE
TP4068AN	CD4068AE
TP4069UBN	CD4069UBE
TP4070BN	CD4070BE
TP4071BN	CD4071BE
TP4072BN	CD4072BE
TP4073BN	CD4073BE
TP4075BN	CD4075BE
TP4081BN	CD4081BE
TP4082BN	CD4082BE
TP4083BN	CD4083BE
TP4511BN	CD4511BE
TP4512BN	CD4512BE
TP4520AN	CD4520AE
$\mu$ PD4001C	CD4001AE
$\mu$ PD4002C	CD4002AE
$\mu$ PD4011C	CD4011AE
$\mu$ PD4012C	CD4012AE
$\mu$ PD4013C	CD4013AE
$\mu$ PD4014C	CD4014AE
$\mu$ PD4015C	CD4015AE
$\mu$ PD4017C	CD4017BE
$\mu$ PD4019C	CD4019AE
$\mu$ PD4020C	CD4020AE
$\mu$ PD4021C	CD4023AE
$\mu$ PD4023C	CD4023AE
$\mu$ PD4024C	CD4024BE
$\mu$ PD4025C	CD4025AE
$\mu$ PD4027C	CD4027AE
$\mu$ PD4028C	CD4028AE
$\mu$ PD4029C	CD4029AE
$\mu$ PD4030C	CD4030AE
$\mu$ PD4034C	CD4034BE
$\mu$ PD4035C	CD4035BE
$\mu$ PD4040C	CD4040BE
$\mu$ PD4042C	CD4042AE
$\mu$ PD4043C	CD4043BE
$\mu$ PD4044C	CD4044BE
$\mu$ PD4049C	CD4049AE
$\mu$ PD4050C	CD4050AE
$\mu$ PD4051C	CD4051BE
$\mu$ PD4052C	CD4052BE
$\mu$ PD4053C	CD4053BE

## Cross-Reference Guide

Industry Type	RCA Replacement Type
$\mu$ PD4063C	CD4063BE
$\mu$ PD4066C	CD4066AE
$\mu$ PD4069C	CD4069UBE
$\mu$ PD4071C	CD4071BE
$\mu$ PD4072C	CD4072BE
$\mu$ PD4073C	CD4073BE
$\mu$ PD4075C	CD4075BE
$\mu$ PD4081C	CD4081BE
$\mu$ PD4082C	CD4082BE
$\mu$ PD4093C	CD4093BE

Industry Type	RCA Replacement Type
$\mu$ PD4094C	CD4094BE
$\mu$ PD4099C	CD4099BE
$\mu$ PD4508C	CD4508BE
$\mu$ PD4510C	CD4510BE
$\mu$ PD4511C	CD4511BE
$\mu$ PD4514C	CD4515BE
$\mu$ PD4516C	CD4516BE
$\mu$ PD4518C	CD4518BE
$\mu$ PD4520C	CD4520BE
$\mu$ PD4532C	CD4532BE

Industry Type	RCA Replacement Type
$\mu$ PD4555C	CD4555BE
$\mu$ PD4556C	CD4556BE

---

# General Operating and Application Considerations

	Page
General Operating and Handling Considerations .....	44
A-Series CMOS Integrated Circuits .....	48
High-Voltage B-Series CMOS Integrated Circuits .....	48

## General Operating and Application Considerations

This section is intended as a guide to circuit and equipment designers in the operation and application of MOS integrated circuits. It covers general operating and handling considerations with respect to the following critical factors:

- Operating supply-voltage range
- Power dissipation and derating
- System noise considerations
- Power-source rules
- Gate-oxide protection networks
- Input signals and ratings
- Chip assembly and storage
- Device mounting
- Testing

More specific information is then given on significant features, special design and application requirements, and standard ratings and electrical characteristics for CMOS A- and B-series logic circuits, and on CMOS special-function circuits (telecommunications and special interface and display driver circuits).

### GENERAL OPERATING AND HANDLING CONSIDERATIONS

The following paragraphs discuss some key operating and handling considerations that must be taken into account to achieve maximum advantage of the CMOS technology. Additional information on the operation and handling of CMOS integrated circuits is given in ICAN-6525, "Guide to Better Handling and Operation of CMOS Integrated Circuits," included in the Application Notes Section of this DATABOOK.

#### Operating Supply-Voltage Range

Because logic systems occasionally experience transient conditions on the power-supply line which, when added to the nominal power-bus voltage, could exceed the safe limits of circuits connected to the power bus, the recommended operating supply-voltage ranges are 3 to 12 volts for A-series devices and 3 to 18 volts for B-series devices. The recommended maximum power-supply limit is substantially below the minimum primary breakdown limit for the devices to allow for limited power-supply transient and regulation limits. For circuits that operate in a linear mode over a portion of the voltage range, such as RC or

crystal oscillators, a minimum supply voltage of 4 volts is recommended.

#### Power Dissipation and Derating

The power dissipation of a CMOS integrated circuit is the sum of a dc (quiescent) component and an ac (dynamic) component. The dc component is the sum of the net integrated-circuit reverse diode-junction current and the surface leakage current times the supply voltage. In standard A- or B-series logic devices, the dc dissipation typically ranges, depending upon device complexity, from 100 to 400 nanowatts for a supply voltage of 10 volts. Worst-case dc dissipation is the product of the maximum quiescent current (given in the data sheet on each device) and the dc supply voltage  $V_{DD}$ .

Dynamic power dissipation has 3 components:

- The dissipation that results from current that charges and discharges the external load capacitance of the output buffers. The dissipation of each output buffer is equal to  $CV^2f$ , where C is the load capacitance, V is the supply voltage, and F is the switching frequency of that output.
- The dissipation that results from current that charges and discharges the internal node capacitances.
- The dissipation caused by the current spikes through the PMOS and NMOS transistors in series at the instant of switching. This component amounts to approximately 10 per cent of the total dissipation, shown graphically in the data sheets of most RCA CMOS circuits.

All CMOS devices are rated at 200 mW per package at the maximum operating ambient temperature rating ( $T_A$ ) for the package type (85°C for plastic packages and 125°C for ceramic packages). Power ratings for temperatures below the maximum operating temperature are shown in the standard CMOS thermal derating chart in Fig. 1. This chart assumes that (a) the device is mounted and soldered (or placed in a socket) on a PC board; (b) there is natural convection cooling, with the PC board mounted horizontally; and (c) the pressure is standard (14.7 psia). In addition to the over-all package dissipation, device dissipation per output transistor is limited to 100 mW maximum over the full package operating-temperature range.

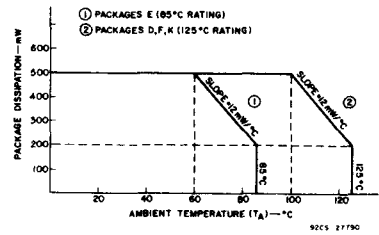

Fig. 1—Standard CMOS thermal derating chart.

#### System Noise Considerations

In general, CMOS devices are much less sensitive to noise on power and ground lines than bipolar logic families (such as TTL or DTL). However, this sensitivity varies as a function of the power-supply voltage, and more importantly as a function of synchronism between noise spikes and input transitions. Good power distribution in digital systems requires that the power bus have a low dynamic impedance; for this purpose, discrete decoupling capacitors should be distributed across the power bus. A more detailed discussion of CMOS noise immunity is provided by ICAN-6587, "Noise Immunity of B-series CMOS Integrated Circuits," in the Application Notes Section.

#### Power-Source Rules

Fig. 2 shows the basic CMOS inverter and its gate-oxide protection network plus inherent diodes. The safe operating procedures listed below can be understood by reference to this inverter.

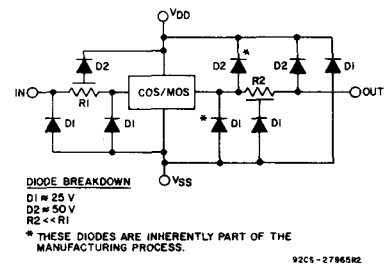

Fig. 2—Basic CMOS inverter with B-series types protection network.

- When separate power supplies are used for the CMOS device and for the device inputs, the device power supply should always be turned on

## General Operating and Application Considerations

before the independent input signal sources, and the input signals should be turned off before the power supply is turned off ( $V_{SS} \leq V_i \leq V_{DD}$  as a maximum limit). This rule will prevent over-dissipation and possible damage to the D2 input-protection diode when the device power supply is grounded. When the device power supply is an open circuit, violation of this rule can result in undesired circuit operation although device damage should not result; ac inputs can be rectified by diode D2 to act as a power supply.

- The power-supply operating voltage should be kept safely below the absolute maximum supply rating, as indicated previously.
- The power-supply polarity for CMOS circuits should not be reversed. The positive ( $V_{DD}$ ) terminal should never be more than 0.5 volt negative with respect to the negative ( $V_{SS}$ ) terminal ( $V_{DD} - V_{SS} > -0.5V$ ). Reversal of polarities will forward-bias and short the structural and protection diode between  $V_{DD}$  and  $V_{SS}$ .
- $V_{DD}$  should be equal to or greater than  $V_{CC}$  for CMOS buffers which have two power supplies (except for the CD40109B, and in particular, for CD-4009 and CD4010 CMOS-to-TTL "down"-conversion devices).
- Power-source current capability should be limited to as low a value as reasonable to assure good logic operation.
- Large values of resistors in series with  $V_{DD}$  or  $V_{SS}$  should be avoided; transient turn-on of input protection diodes can result from drops across such resistors during switching.

### Gate-Oxide Protection Network

A problem occasionally encountered in handling and testing low-power semiconductor devices, including MOS and small-geometry bipolar devices, has been damage to gate oxide and/or p-n junctions. Fig. 3 shows the gate-oxide protection circuits used to protect CMOS devices from static electricity damage. ICAN-6572 gives further information on protection circuits. Although these circuits are included in all CMOS devices, the handling precautions in ICAN-6572 and ICAN-6525 should be observed.

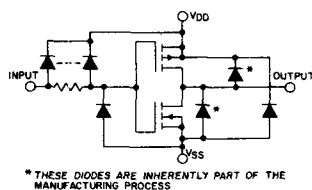

(a) For standard A-series CMOS product.

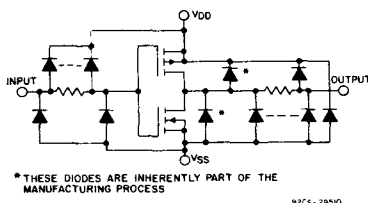

(b) For improved B-series CMOS product.

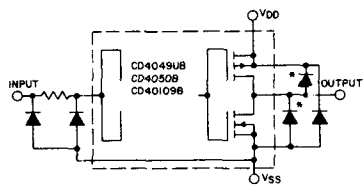

(c) For CD4049UB, CD4050B, and CD40109B CMOS types.

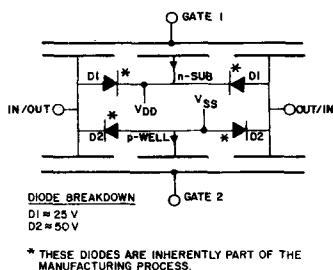

(d) For CMOS transmission gates.

Fig. 3—Gate-oxide protection networks used in RCA CMOS integrated circuits.

### Input Signals and Ratings

- Input signals should be maintained within the power-supply voltage range,  $V_{SS} \leq V_i \leq V_{DD}$ . If the input signal exceeds the recommended input-signal-swing range, the input current

should be limited to  $\pm 100 \mu A$  to minimize cross talk between input signals on adjacent terminals, and also to minimize any reduction in noise immunity.

The absolute-maximum input-current rating of  $\pm 10$  mA, shown in the published data, protects the device against the possible occurrence of an induced  $V_{DD} - V_{SS}$  latch condition, or damage to the input protection diodes. Latch-up conditions are explained in ICAN-6525.

- ALL CMOS inputs should be terminated. An exception can be made in the case of unbuffered NOR and NAND gates (A-series and UB types) where terminating one of the series inputs to the proper polarity will not permit current flow caused by a floating input. Thus, tying low one of the inputs of an unbuffered NAND gate, or tying high one of the inputs of an unbuffered NOR gate will satisfy this requirement.

When CMOS inputs are wired to edge card connectors with CMOS drive coming from another PC board, a shunt resistor in the range of 100 kohms should be connected to  $V_{DD}$  or  $V_{SS}$ , as applicable, in case the inputs become unterminated with the power supply on.

- When CMOS circuits are driven by TTL logic, a "pull-up" resistor should be connected from the CMOS input to 5 volts (further information is given in ICAN-6602).

### Output Rules

- The power dissipation in a CMOS package should not exceed the rated value for the ambient temperature specified. The actual dissipation should be calculated when (a) shorting outputs directly to  $V_{DD}$  or  $V_{SS}$ , (b) driving low-impedance loads, or (c) directly driving the base of p-n-p or n-p-n bi-polar transistor.
- Output short circuits often result from testing errors or improper board assembly. Shorts on buffer outputs or across power supplies greater than 5 volts can damage CMOS devices.
- CMOS, like active pull-up TTL, cannot be connected in the "wire-OR" configuration because an "on" PMOS and an "on" NMOS transistor could be

## General Operating and Application Considerations

directly shorted across the power-supply rails. (Exception: CD40107B)

- Paralleling inputs and outputs of gates is recommended only when the gates are within the same IC package.
- Output loads should return to a voltage within the supply-voltage range ( $V_{DD}$  to  $V_{SS}$ ).
- Large capacitive loads (greater than 5000 pF) on CMOS buffers or high-current drivers act like short circuits and may over-dissipate output transistors.
- Output transistors may be over-dissipated by operating buffers as linear amplifiers or using these types as one-shot or astable multivibrators.

### Noise Immunity and Noise Margin

The complementary structure of the inverter, common to all CMOS logic devices, results in a near-ideal input-output transfer characteristic, with switching point midway (45% to 55%) between the 0 and 1 output logic levels. The result is high dc noise immunity.

Fig. 4 shows a typical transfer curve that may be used to define the dc noise immunity of CMOS integrated circuits. The noise-immunity voltage ( $V_{IL}$  or  $V_{IH}$ ) is the noise voltage at any one input that does not propagate through the system. Minimum noise immunity for buffered B-series CMOS devices is 30, 30, and 27 per cent, respectively for supply voltages  $V_{DD}$  of 5, 10, 15 volts and 20 per cent of  $V_{DD}$  for all unbuffered gates. The  $V_{IL}$  and  $V_{IH}$  specifications define the maximum permissible additive noise voltage at an input terminal when input signals are within 50 millivolts of the supply rails.

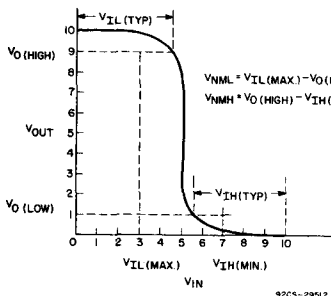

Fig. 4—Typical transfer curve for an inverting gate at  $V_{DD} = 10$  V.

Noise margin is the difference between the noise-immunity voltage ( $V_{IL}$  or  $V_{IH}$ ) and the output voltage  $V_O$ . Noise-margin voltage is the maximum voltage that can be impressed upon an input voltage  $V_{IN}$  (where  $V_{IN}$  is the  $V_{OL}$  or  $V_{OH}$  voltage of the preceding stage) at any (or all) logic I/O terminals without upsetting the logic or causing any output to exceed the output voltage ( $V_O$ ) conditions specified for  $V_{IL}$  and  $V_{IH}$  ratings. Fig. 5 illustrates the noise-margin concept in a simple system. Minimum noise margins for buffered B-series CMOS devices are 1, 2, and 2.5 volts, respectively, for supply voltages of 5, 10, and 15 volts.

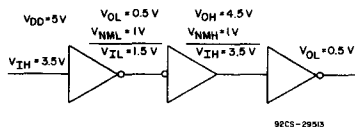

Fig. 5—Noise margin example using inverters.

Of the two noise-limitation specifications (noise immunity and noise margin), RCA considers noise immunity to be more practical for CMOS devices because CMOS outputs are normally within 50 millivolts of supply rails.

Noise immunity increases as the input pulse width becomes less than the propagation delay of the circuit. This condition is often described as ac noise immunity. (Further information on noise immunity is given in ICAN-6587).

### Clock Rise- and Fall-Time Requirements

Most CMOS clocked devices have maximum rise- and fall-time ratings (normally 5 to 15 microseconds). With longer rise or fall times, a device may not function properly because of data ripple-through, false triggering problems, etc. Some B-series CMOS counters have Schmitt-trigger shaping circuits built into the clock circuit, removing the restriction for input rise or fall times. Long rise and fall times on CMOS buffer-type inputs cause increased power dissipation which may exceed device capability for operating power-supply voltages greater than 5 volts.

### Parallel Clocking

Process variations leading to differences in input threshold voltage among random device samples can cause loss of

data between certain synchronously clocked sequential circuits, as shown in Fig. 6. This problem can be avoided if the maximum clock rise time ( $t_{r,CL}$ ) for cascading any two CMOS sequential devices is limited in accordance with the following equations:

#### A Series Types

$$\text{Maximum } t_{r,CL} = \frac{0.8 V_{DD} (v)}{1.25 (v)} \times t_p(ns)$$

#### B Series Types

$$\text{Maximum } t_{r,CL} = \frac{0.8 V_{DD} (v)}{1.15 (v)} \times t_p(ns)$$

where  $t_p = t_{PHL}$  or  $t_{PLH}$  (whichever is smaller) for the unit A in Fig. 6 as specified on the device data sheet at the specified value of  $V_{DD}$  and loading conditions. Schmitt trigger circuits such as the CD-4093B are an ideal solution to applications requiring wave-shaping.

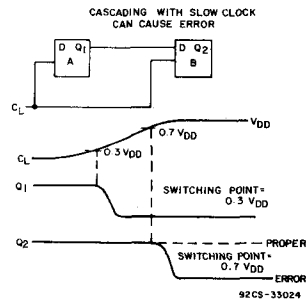

Fig. 6—Error effect that results from a slow clock in cascaded circuits.

### Three-State Logic

Three-state logic can be easily implemented by use of a transmission gate in the output circuit; this technique provides a solution to the wire-OR problem in many cases.

### Chip Assembly and Storage

RCA CMOS integrated circuits are provided in a chip form (H suffix) to allow customer design of special and complex circuits to suit individual needs. CMOS chips are electrically identical to and offer the features of their counterparts sealed in ceramic and plastic packages. The following paragraphs describe mounting considerations, packaging, shipping and storage criteria, handling criteria, visual



## General Operating and Application Considerations

inspection criteria, testing criteria, and bonding pad layout and dimensions for each chip.

**Mounting Considerations.** All CMOS chips are non-gold backed and require the use of epoxy mounting. DuPont No's. 6838 or 5504A conductive silver paste or equivalent is recommended. In any case the manufacturer's recommendations for storage and use should be followed. If DuPont No., 6838 or 5504A paste is used, the bond should be cured at temperatures between 185°C and 200°C for 75 minutes.

**In CMOS circuits MOS-transistor p-channel substrates (n-type bulk material) are connected to  $V_{DD}$ , therefore, when chips are mounted and a conductive paste is used care must be taken to keep the active substrate isolated from ground or other circuit elements.**

**Packing, Shipping, and Storage Criteria.** Solid-state chips, being small in size and unencapsulated, are physically fragile and small in physical size, and therefore, require special handling considerations as follows:

1. Chips must be stored under proper conditions to insure that they are not subjected to a moist and/or contaminated atmosphere that could alter their electrical, physical, or mechanical characteristics. After the shipping container is opened, the chip must be stored under the following conditions:
  - A. Storage temperature, 40°C max.
  - B. Relative humidity, 50% max.
  - C. Clean, dust-free environment.
2. The user must exercise proper care when handling chips to prevent even the slightest physical damage to the chip.
3. During mounting and lead bonding of chips the user must use proper assembly techniques to obtain proper electrical, thermal, and mechanical performance.
4. After the chip has been mounted and bonded, any necessary procedure must be followed by the user to insure that these non-hermetic chips are not subjected to a moist and contaminated atmosphere which might cause the development of electrical conductive paths across the relatively small insulating surfaces. In addition, proper consideration must be given to the

protection of these devices from other harmful environments which could conceivably affect their performance and/or reliability.

**Handling Criteria.** The user should find the following suggested precautions helpful in handling CMOS chips.

Because of the extremely small size and fragile nature of chips, the equipment designer should exercise care in handling these devices.

For additional handling considerations for CMOS devices, refer to ICAN-6525, "Guide to Better Handling and Operation of CMOS integrated Circuits."

### 1. Grounding

- a. Bonders, pellet pick-up tools, table tops, trim and form tools, sealing equipment, and other equipment used in chip handling should be properly grounded.
- b. The operator should be properly grounded.

### 2. In-Process Handling

- a. Assemblies or subassemblies of chips should be transported and stored in conductive carriers.
- b. All external leads of the assemblies or subassemblies should be shorted together.

### 3. Bonding Sequence

- a. Connect  $V_{DD}$  first to external connections, for example, terminal 14 of the CD4001AH.
- b. Remaining functions may be connected to their external connections in any sequence.

### 4. Testing

- a. Transport all assemblies of chips in conductive carriers.
- b. In testing chip assemblies or subassemblies, the operator should be properly grounded.

**Visual Inspection Criteria.** All standard commercial CMOS chips undergo a visual inspection which is patterned after MIL-STD-883, Method 2010, Condition B with modifications reflecting CMOS requirements.

**Testing Criteria.** CMOS chips are dc electrically tested 100% in accordance with the same standards prescribed for RCA devices in standard packages.

### Device Testing

RCA CMOS circuits are 100-percent

tested by circuit probe in the wafer stage and are 100-percent tested again after they have been packaged. DC tests of RCA devices are performed at 5, 10, 15, and 20 volts; functionality is checked at 2.8, 17, and 20 volts depending on family (i.e., A or B series). Sample testing is used to assure adherence to quality requirements and ac specifications.

Static tests, high-speed functional and dc parametric tests, are performed at wafer and package stages by means of a Teradyne J283 test set. A Teradyne S157CM test set and a Macrodata MD154 test set are used in dynamic testing. Dynamic tests are performed with 15 and 50 picofarad loads. Testing at 15 picofarads is accomplished primarily by laboratory "bench-test" techniques; automatic testing at 15 picofarads is difficult because of the high input capacitance (approximately 20 to 35 picofarads) of most automatic ac test sets.

Users should follow the sequence below when testing CMOS devices:

1. Insert the device into the test socket.
2. Apply  $V_{DD}$ .
3. Apply the input signal.
4. Perform the test.
5. On completion of test, remove the input signal.
6. Turn off the power supply ( $V_{DD}$ ).
7. Remove the device from the test socket and insert it into a conductive carrier. CMOS devices under test must not be exposed to electrostatic discharge or forward biasing of the intrinsic protective diodes shown in Fig. 3.

Detailed information on the techniques employed in the testing of RCA CMOS integrated circuits are described in ICAN-6532 included in the Application Notes Section of this DATABOOK.

### Device Mounting

Integrated circuits are normally supplied with lead-tin plated leads to facilitate soldering into circuit boards. In those relatively few applications requiring welding of the device leads, rather than soldering, the devices may be obtained with nickel-plated Kovar leads.\* It should be recognized that this type of plating will not provide complete protection against lead corrosion in the presence of high humidity and mechanical stress.

\*MIL-M-38510, paragraph 3.5.6.1 (a), lead material

# General Operating and Application Considerations

In any method of mounting integrated circuits which involves bending or forming of the device leads, it is extremely important that the lead be supported and clamped between the bend and the package seal, and that bending be done with care to avoid damage to lead plating. In no case should the radius of the bend be less than the diameter of the lead. It is also extremely important that the ends of bent leads be straight to assure proper insertion through the holes in the printed-circuit board.

## A-SERIES CMOS INTEGRATED CIRCUITS

RCA CD4000A-series types have a maximum dc supply-voltage rating of -0.5 to 15 volts, and a recommended operating supply-voltage range of 3 to 12 volts. The major features of this series are as follows:

- Quiescent current specified to 15 volts
- 5-volt and 10-volt parametric ratings
- Maximum input leakage of  $1 \mu\text{A}$  at 15 volts over the full package operating-temperature range
- 1-volt noise margin (full package temperature range)

Table I shows the maximum ratings and the recommended operating supply-voltage range for RCA A-series CMOS integrated circuits.

### Static Electrical Characteristics

Table II shows the standard dc electrical characteristics for A-series types. The data sheet for each of these types contains the family characteristics shown in Table I plus additional dc characteristics that are type-dependent.

### Dynamic Electrical Characteristics

A-series dynamic electrical characteristics are specified for individual types under the following conditions:  $V_{DD} = 5 \text{ V}$  and  $10 \text{ V}$ ;  $T_A = 25^\circ\text{C}$  (temperature coefficient is typically  $0.3\%/^\circ\text{C}$ );  $C_L = 15 \text{ pF}$ ;  $t_r$  and  $t_f$  of inputs =  $20 \text{ ns}$ .

## HIGH-VOLTAGE B-SERIES CMOS INTEGRATED CIRCUITS

RCA-CD4000B-series types have a maximum dc supply-voltage rating of -0.5 to 20 volts, and a recommended operating supply-voltage range of 3 to 18 volts. The

major features of this series are as follows:

- High-voltage (20-V) ratings
- 100% tested for quiescent current at 20 V
- 5-V, 10-V, and 15-V parametric ratings
- Standardized, symmetrical output characteristics
- Maximum input current of  $1 \mu\text{A}$  at 18 V over full-package-temperature range;  $100 \text{ nA}$  at 18 V and  $25^\circ\text{C}$
- Noise margin (full package-temperature range) =
  - $1 \text{ V}$  at  $V_{DD} = 5 \text{ V}$
  - $2 \text{ V}$  at  $V_{DD} = 10 \text{ V}$
  - $2.5 \text{ V}$  at  $V_{DD} = 15 \text{ V}$
- Meets all requirements of JEDEC Tentative Standard No. 13B, "Standard Specifications for Description of 'B' Series CMOS Devices"

### JEDEC Minimum Standard

Under the sponsorship of the Joint Electron Devices Engineering Council (JEDEC) of the Electronic Industries Association (EIA), minimum industrial standards have been established for the

**Table I — Maximum Ratings and Recommended Operating Conditions for A-Series CMOS Integrated Circuits**

#### MAXIMUM RATINGS, Absolute-Maximum Values:

DC SUPPLY-VOLTAGE RANGE, ( $V_{DD}$ ) (Voltages referenced to $V_{SS}$ Terminal)	-0.5 to +15 V
INPUT VOLTAGE RANGE, ALL INPUTS	-0.5 to $V_{DD} + 0.5 \text{ V}$
POWER DISSIPATION PER PACKAGE ( $P_D$ ):	
For $T_A = -40$ to $+80^\circ\text{C}$ (PACKAGE TYPE E)	500 mW
For $T_A = +60$ to $+85^\circ\text{C}$ (PACKAGE TYPE E)	Derate Linearly to 200 mW
For $T_A = -55$ to $+100^\circ\text{C}$ (PACKAGE TYPES D, F, K, H)	500 mW
For $T_A = +100$ to $+125^\circ\text{C}$ (PACKAGE TYPES D, F, K, H)	Derate Linearly to 100 mW
DEVICE DISSIPATION PER OUTPUT TRANSISTOR:	
For $T_A = \text{FULL PACKAGE-TEMPERATURE RANGE}$ (All Package Types)	100 mW
OPERATING-TEMPERATURE RANGE ( $T_A$ ):	
PACKAGE TYPES D, F, K, H	-55 to $+125^\circ\text{C}$
PACKAGE TYPE E	-40 to $+85^\circ\text{C}$
STORAGE TEMPERATURE RANGE ( $T_{STG}$ )	-65 to $+150^\circ\text{C}$
LEAD TEMPERATURE (DURING SOLDERING):	
At distance $1/16 \pm 1/32$ inch ( $1.59 \pm 0.79 \text{ mm}$ ) from case for 10 s max.	$+265^\circ\text{C}$

### RECOMMENDED OPERATING CONDITIONS

For maximum reliability, nominal operating conditions should be selected so that operation is always within the following ranges:

CHARACTERISTIC	LIMITS		UNITS
	Min.	Max.	
Supply-Voltage Range (For $T_A = \text{Full Package-Temperature Range}$ )	3	12	V

## General Operating and Application Considerations

**Table II — A-Series Static Electrical Characteristics (Full Package Temperature Range)**

SYMBOL	PARAMETER	CONDITIONS				LIMITS			UNITS
		V <sub>IN</sub>	V <sub>O</sub> (volts)		V <sub>DD</sub>	MIN.	TYP.	MAX.	
		VOLTS	MIN.	MAX.	VOLTS				
V <sub>OL</sub>	Output Low Voltage	5	—	—	5	—	0	0.05	V
		10	—	—	10	—	0	0.05	V
V <sub>OH</sub>	Output High Voltage	0	—	—	5	4.95	5	—	V
		0	—	—	10	9.95	10	—	V
V <sub>NL</sub> (SSI Types)	Noise Voltage (Input Low)	—	3.6	—	5	1.5	2.25	—	V
		—	7.2	—	10	3	4.5	—	V
V <sub>NH</sub> (SSI Types)	Noise Voltage (Input High)	—	—	1.4	5	1.5	2.25	—	V
		—	—	2.8	10	3	4.5	—	V
V <sub>NL</sub> (MSI Types)	Noise Voltage (Input Low)	—	4.2	—	5	1.5	2.25	—	V
		—	9.0	—	10	3	4.5	—	V
V <sub>NH</sub> (MSI Types)	Noise Voltage (Input High)	—	—	0.8	5	1.5	2.25	—	V
		—	—	1.0	10	3	4.5	—	V
V <sub>NML</sub>	Noise Margin (Input Low)	—	4.5	—	5	1	—	—	V
		—	9.0	—	10	1	—	—	V
V <sub>NMH</sub>	Noise Margin (Input High)	—	—	0.5	5	1	—	—	V
		—	—	1.0	10	1	—	—	V
I <sub>IL</sub> , I <sub>IH</sub>	Input Leakage Low	—	—	—	15	—	± 10 <sup>-5</sup>	± 1	μA
I <sub>L</sub>	Quiescent Device Leakage	—	—	—	5, 10, 15	See Data Sheets			μA
I <sub>DN</sub> , I <sub>DP</sub>	Output Source and Sink current	—	—	—	5, 10	See Data Sheets			mA

Note: Logic Level Inversion Assumed in Table II.

maximum ratings, static and ac electrical characteristics of B-series CMOS integrated circuits. The JEDEC standard (JEDEC Tentative Standard No. 13B) defines B-series CMOS integrated circuits as a uniform family of both buffered and unbuffered types that have an absolute dc supply-voltage rating of at least 18 volts.

**Buffered CMOS devices** are types in which the output "on" impedance is independent of any and all valid input logic conditions, both preceding and present. All such CMOS product are designated by the suffix "B" following the basic type number.

**Unbuffered CMOS devices** are types that meet all B-series specifications except that the logical outputs are not buffered and the noise-immunity voltages, V<sub>IL</sub> and V<sub>IH</sub>, are specified as 20 and 80 per cent, respectively, of V<sub>DD</sub> for operation from 5 or 10 volts, and 17 and 83 per cent, respectively, of V<sub>DD</sub> for operation from 15 volts. All such CMOS product are designated by the suffix "UB".

The JEDEC minimum standard also includes in the B-series CMOS types that have analog inputs or outputs and, in addition, have maximum ratings and logical input and output parameters that conform to B-series specifications wherever applicable. These CMOS devices are also designated by the suffix "B".

All B-series CMOS devices can directly replace their A-series counterparts in most applications. The UB types are high-voltage versions of corresponding A-series (unbuffered) types.

Table III lists the JEDEC minimum standards established for the maximum ratings and recommended operating conditions for B-series CMOS integrated circuits.

Table IV shows the JEDEC standards for the static electrical characteristics of CMOS B-series integrated circuits.

### Standardized RCA Ratings and Static Characteristics

RCA B-series CMOS integrated cir-

cuits meet or exceed the most stringent requirements of the JEDEC B-series specifications. Table V shows the standardized maximum ratings and recommended operating supply-voltage range for RCA B-series CMOS integrated circuits. The standardized static electrical characteristics for these devices are shown in Table VI. As with the JEDEC specifications, the RCA standardized characteristics classifies the B-series devices into three leakage (quiescent-device-current) categories. Table VII lists the RCA types in each category and indicates types that, although they are still B-series types, differ in one or more static characteristics.

Tables V and VI show that, in a number of important respects, RCA has established new performance standards for B-series CMOS logic circuits.

### 1. Tight limits for all packages

RCA devices use the same set of limits for all package styles. The JEDEC standard establishes two sets of limits for most dc (static) parameters; a

# General Operating and Application Considerations

**Table III - JEDEC Minimum Standards for Maximum Ratings and Recommended Operating Conditions for B-series CMOS Integrated Circuits\***

**Absolute Maximum Ratings** (Voltages referenced to  $V_{SS}$ ):

DC Supply Voltage	$V_{DD}$	-0.5 to +18	Vdc
Input Voltage	$V_{IN}$	-0.5 to $V_{DD} + 0.5$	Vdc
DC Input Current (any one input)	$I_{IN}$	$\pm 10$	mAdc
Storage-Temperature Range	$T_s$	-65 to +150	°C

**Recommended Operating Conditions:**

DC Supply Voltage	$V_{DD}$	+3 to +15	Vdc
Operating-Temperature Range, $T_A$			
Military-Range Devices		-55 to +125	°C
Commercial-Range Devices		-40 to +85	°C

\*Reprinted from JEDEC Tentative Standard No. 13-B, "Standard Specifications for Description of B-Series CMOS Devices."

**Table IV - JEDEC Standard for Static Characteristics of B-Series CMOS Integrated Circuits<sup>▲</sup>**

PARAMETER	TEMP. RANGE	$V_{DD}$ (Vdc)	CONDITIONS	LIMITS						Units		
				T <sub>LOW</sub> *		+25°C			T <sub>HIGH</sub> *			
				Min	Max	Min	Typ	Max	Min		Max	
$I_{DD}$	Quiescent Device Current	Mil	5 10 15	$V_{IN} = V_{SS}$ or $V_{DD}$		0.25 0.5 1.0			0.25 0.5 1.0		7.5 15 30	uAdc
	BUFFERS, FLIP-FLOPS	Mil	5 10 15	$V_{IN} = V_{SS}$ or $V_{DD}$		1.0 2.0 4.0			1.0 2.0 4.0		30 60 120	
	MSI	Mil	5 10 15	$V_{IN} = V_{SS}$ or $V_{DD}$		5 10 20			5 10 20		150 300 600	
$V_{OL}$	Low-Level Output Voltage	All	5 10 15	$V_{IN} = V_{SS}$ or $V_{DD}$ $ I_O  < 1\mu A$		0.05 0.05 0.05				0.05 0.05 0.05	Vdc	
$V_{OH}$	High-Level Output Voltage	All	5 10 15	$V_{IN} = V_{SS}$ or $V_{DD}$ $ I_O  < 1\mu A$	4.95 9.95 14.95				4.95 9.95 14.95			Vdc
$V_{IL}$	Input Low Voltage	All	5 10 15	$V_O = 0.5V$ or $4.5V$ $V_O = 1.0V$ or $9.0V$ $V_O = 1.5V$ or $13.5V$ $ I_O  < 1\mu A$		1.5 3.0 4.0			1.5 3.0 4.0		1.5 3.0 4.0	Vdc
$V_{IH}$	Input High Voltage	All	5 10 15	$V_O = 0.5V$ or $4.5V$ $V_O = 1.0V$ or $9.0V$ $V_O = 1.5V$ or $13.5V$ $ I_O  < 1\mu A$		3.5 7.0 11.0			3.5 7.0 11.0		3.5 7.0 11.0	Vdc

## General Operating and Application Considerations

Table IV - JEDEC Standard for Static Characteristics of B-series CMOS Integrated Circuits (cont'd)

PARAMETER	TEMP. RANGE	V <sub>DD</sub> (Vdc)	CONDITIONS	LIMITS						Units	
				T <sub>LOW</sub> *		+25° C			T <sub>HIGH</sub> *		
				Min	Max	Min	Typ	Max	Min		Max
I <sub>OL</sub>	Output Low (Sink) Current	Mil	5	V <sub>O</sub> = 0.4V V <sub>IN</sub> = 0 or 5V	0.64		0.51			0.36	mAdc
			10	V <sub>O</sub> = 0.5V, V <sub>IN</sub> = 0 or 10V	1.6		1.3		0.9		
			15	V <sub>O</sub> = 1.5V, V <sub>IN</sub> = 0 or 15V	4.2		3.4		2.4		
		Comm	5	V <sub>O</sub> = 0.4V, V <sub>IN</sub> = 0 or 5V					0.36		
			10	V <sub>O</sub> = 0.5V, V <sub>IN</sub> = 0 or 10V	0.52		0.44		0.9		
			15	V <sub>O</sub> = 1.5V, V <sub>IN</sub> = 0 or 15V	1.3		1.1		2.4		
I <sub>OH</sub>	Output High (Source) Current	Mil	5	V <sub>O</sub> = 4.6V, V <sub>IN</sub> = 0 or 5V	-0.25		-0.2			-0.14	mAdc
			10	V <sub>O</sub> = 9.5V, V <sub>IN</sub> = 0 or 10V	-0.62		-0.5			-0.35	
			15	V <sub>O</sub> = 13.5V, V <sub>IN</sub> = 0 or 15V	-1.8		-1.5			-1.1	
		Comm	5	V <sub>O</sub> = 4.6V V <sub>IN</sub> = 0 or 5V					-0.12		
			10	V <sub>O</sub> = 9.5V, V <sub>IN</sub> = 0 or 10V	-0.2		-0.16		-0.3		
			15	V <sub>O</sub> = 13.5V, V <sub>IN</sub> = 0 or 15V	-0.5		-0.4		-1.0		
I <sub>IN</sub>	Input Current	Mil	15	V <sub>IN</sub> = 0 or 15V		±0.1			±0.1	±1.0	uAdc
		Comm	15	V <sub>IN</sub> = 0 or 15V		±0.3			±0.3	±1.0	uAdc
I <sub>OUTMAX</sub>	3-State Output Leakage Current	Mil	15	V <sub>IN</sub> = 0 or 15V		±0.4			±0.4	±12	uAdc
		Comm	15	V <sub>IN</sub> = 0 or 15V		±1.6			±1.6	±12	uAdc
C <sub>IN</sub>	Input Capacitance per Unit Load	All	—	Any Input					7.5		pF

\*T<sub>LOW</sub> = -55° C for Military Temp. Range device, -40° C for Commercial Temp. Range device

\*T<sub>HIGH</sub> = +125° C for Military Temp. Range device, +85° C for Commercial Temp. Range device

▲ Reprinted from JEDEC Tentative Standard No. 13-B, "JEDEC Standard Specification for Description of B-series CMOS Devices."

tight set for products having a full operating temperature range of -55°C to +125°C (normally used for ceramic packages), and a relaxed set for products having a limited temperature range of -40°C to +85°C (normally used for plastic packages). Because RCA supplies only one premium grade of B-series product in all package styles (i.e., fall-out chips are not used), all B-series CMOS devices are specified to the tight set of limits only.

### 2. Improved voltage rating

All RCA B-series devices are tested to voltages that insure safe operation at the absolute maximum dc supply voltage rating of 20 volts. This higher rating permits greater derating for reliable 15-volt operation, permits greater 15-volt supply tolerance and peak transients, and permits system use to 18-volts with confidence.

### 3. Wider operating range

All RCA B-series devices have a rec-

ommended maximum operating voltage of 18 volts. This higher limit permits 18-volt system supply operation, and also permits wider power-source tolerances and transients for supplies normally set up to 18 volts.

### 4. Lower leakage current

The JEDEC standard establishes three sets of limits for quiescent device current (I<sub>DD</sub>) intended to match chip complexity to device leakage current as realistically as possible.

# General Operating and Application Considerations

**Table V - RCA Standardized Maximum Ratings and Recommended Operating Conditions for B-Series CMOS Integrated Circuits**

**Maximum Ratings, Absolute-Maximum Values**

DC SUPPLY-VOLTAGE RANGE, ( $V_{DD}$ ) (Voltages referenced to $V_{SS}$ Terminal)	-0.5 to +20 V
INPUT VOLTAGE RANGE, ALL INPUTS	-0.5 to $V_{DD}$ +0.5 V
DC INPUT CURRENT, ANY ONE INPUT	$\pm 10$ mA
POWER DISSIPATION PER PACKAGE ( $P_D$ ):	
For $T_A = -40$ to $+60^\circ$ C (PACKAGE TYPE E)	500 mW
For $T_A = +60$ to $+85^\circ$ C (PACKAGE TYPE E)	Derate Linearly at 12mW/ $^\circ$ C to 200 mW
For $T_A = -55$ to $+100^\circ$ C (PACKAGE TYPES D, F, K)	500 mW
For $T_A = +100$ to $+125^\circ$ C (PACKAGE TYPES D, F, K)	Derate Linearly at 12 mW/ $^\circ$ C to 200 mW
DEVICE DISSIPATION PER OUTPUT TRANSISTOR	
For $T_A =$ FULL PACKAGE-TEMPERATURE RANGE (All Package Types)	100 mW
OPERATING-TEMPERATURE RANGE ( $T_A$ ):	
PACKAGE TYPES D, F, K, H	-55 to $+125^\circ$ C
PACKAGE TYPE E	-40 to $+85^\circ$ C
STORAGE-TEMPERATURE RANGE ( $T_{stg}$ )	-65 to $+150^\circ$ C
LEAD TEMPERATURE (DURING SOLDERING):	
At distance $1/16 \pm 1/32$ inch ( $1.59 \pm 0.79$ mm) from case for 10 s max	$+265^\circ$ C

**Recommended Operating Conditions:**

For maximum reliability, nominal operating conditions should be selected so that operation is always within the following ranges:

CHARACTERISTIC	LIMITS		UNITS
	MIN.	MAX.	
Supply-Voltage Range (For $T_A =$ Full Package Temperature Range)	3	18	V

For all three levels of chip complexity, all RCA B-series devices (regardless of package) conform to the tighter set of limits established in the standard. In addition, a maximum rating is specified at 20V, as well as at 5V, 10V, and 15V. As a result:

- (a) In current-limited applications, CMOS users can depend on one tight leakage limit independent of package style selected.
- (b) Customer use of CMOS product up through 18 volts is protected by a published tight leakage current specification at 20 volts (as well as by an input leakage specification at 18 volts).

**5. Symmetrical output**

Most RCA B-series devices have balanced complementary output drive (i.e., the output high current  $I_{OH}$  rating is the same as the output low current  $I_{OL}$  rating) specified to the tighter set

of limits established in the JEDEC standard. The balanced output provides uniform rise and fall time performance, improved system noise energy (dynamic) immunity, optimum device speed for both output switching low-to-high ( $t_{PLH}$ ) and output switching high-to-low ( $t_{PHL}$ ), and in general the identical high and low dc and ac characteristics normally associated with a good complementary output drive circuit. MOS system design, simulation, and performance are significantly enhanced by equal high and low dc and ac performance ratings and one tight specification limit for all package styles.

**6. Improved input current (leakage) ratings**

All RCA B-series devices (regardless of package) have a maximum input leakage current ( $I_{IK}$ ) rating of 100 nA specified at voltages up to 18 V, and a

maximum limit of 1  $\mu$ A at the upper limit of the package-temperature range. Actually, the 100 nA rating is a practical specification limited by the inability of commercial test equipment to measure lower currents. Laboratory tests show that input leakage currents of RCA B-series CMOS devices are significantly lower than this limit, typically ranging from 10 to 100 pA.

**7. Buffered and unbuffered gates**

The new industry standard establishes a suffix "UB" for CMOS products that meet all B-series specifications except that the logical outputs of the devices are not buffered and the  $V_{IL}$  and  $V_{IH}$  specifications are relaxed. The suffix "B" defines only buffered-output devices in which the output "on" impedance is independent of any and all valid input logic conditions, both preceding and present.

# General Operating and Application Considerations

**Table VI — RCA B-series CMOS Standardized Electrical Characteristics**

CHARACTER- ISTIC	CONDITIONS			LIMITS AT INDICATED TEMPERATURES (°C)							UNITS
	V <sub>O</sub> (V)	V <sub>IN</sub> (V)	V <sub>DD</sub> (V)	Values at -55, +25, +125 Apply to D, F, K, H Packages				Values at -40, +25, +85 Apply to E Package			
				-55	-40	+85	+125	+25			
				Min.      Typ.      Max.							
Quiescent Device Current, I <sub>DD</sub> Max. Gates, Inverters <sup>▲</sup>	—	0,5	5	0.25	0.25	7.5	7.5	—	0.01	0.25	μA
	—	0,10	10	0.5	0.5	15	15	—	0.01	0.5	
	—	0,15	15	1	1	30	30	—	0.01	1	
	—	0,20	20	5	5	150	150	—	0.02	5	
Buffers, Flip-Flops, Latches, Multi- Level Gates (MSI-1 Types) <sup>▲</sup>	—	0,5	5	1	1	30	30	—	0.02	1	
	—	0,10	10	2	2	60	60	—	0.02	2	
	—	0,15	15	4	4	120	120	—	0.02	4	
	—	0,20	20	20	20	600	600	—	0.04	20	
Complex Logic (MSI-2 Types) <sup>▲</sup>	—	0,5	5	5	5	150	150	—	0.04	5	
	—	0,10	10	10	10	300	300	—	0.04	10	
	—	0,15	15	20	20	600	600	—	0.04	20	
	—	0,20	20	100	100	3000	3000	—	0.08	100	
Output Low (Sink) Current I <sub>OL</sub> Min.	0.4	0,5	5	0.64	0.61	0.42	0.36	0.51	1	—	mA
	0.5	0,10	10	1.6	1.5	1.1	0.9	1.3	2.6	—	
	1.5	0,15	15	4.2	4	2.8	2.4	3.4	6.8	—	
Output High (Source) Current, I <sub>OH</sub> Min.	4.6	0,5	5	-0.64	-0.61	-0.42	-0.36	-0.51	-1	—	
	2.5	0,5	5	-2	-1.8	-1.3	-1.15	-1.6	-3.2	—	
	9.5	0,10	10	-1.6	-1.5	-1.1	-0.9	-1.3	-2.6	—	
—	13.5	0,15	15	-4.2	-4	-2.8	-2.4	-3.4	-6.8	—	
Output Voltage: Low-Level, V <sub>OL</sub> Max.	—	0,5	5	0.05				—	0	0.05	V
	—	0,10	10	0.05				—	0	0.05	
	—	0,15	15	0.05				—	0	0.05	
Output Voltage: High-Level V <sub>OH</sub> Min.	—	0,5	5	4.95				4.95	5	—	
	—	0,10	10	9.95				9.95	10	—	
	—	0,15	15	14.95				14.95	15	—	
Input Low Voltage, V <sub>IL</sub> Max. B Types UB Types	0.5, 4.5	—	5	1.5				—	—	1.5	V
	1, 9	—	10	3				—	—	3	
	1.5, 13.5	—	15	4				—	—	4	
	0.5, 4.5	—	5	1				—	—	1	
	1, 9	—	10	2				—	—	2	
	1.5, 13.5	—	15	2.5				—	—	2.5	
Input High Voltage, V <sub>IH</sub> Min. B Types UB Types	0.5, 4.5	—	5	3.5				3.5	—	—	
	1, 9	—	10	7				7	—	—	
	1.5, 13.5	—	15	11				11	—	—	
	0.5, 4.5	—	5	4				4	—	—	
	1, 9	—	10	8				8	—	—	
	1.5, 13.5	—	15	12.5				12.5	—	—	
Input Current I <sub>IN</sub> Max.	—	0,18	18	±0.1	±0.1	±1	±1	—	±10 <sup>-5</sup>	±0.1	μA
3-State Output Leakage Current I <sub>OUT</sub> Max.	0, 18	0,18	18	±0.4	±0.4	±12	±12	—	±10 <sup>-4</sup>	±0.4	μA

<sup>▲</sup>Classifications of RCA CMOS B-Series Types are shown in Table VII.

# General Operating and Application Considerations

Table VII—Classification of RCA B-series CMOS Integrated Circuits According to Circuit Complexity

Gates/ Inverters		Buffers/Flip-Flop/ Latches/Multi-Level Gates (MSI-1)		Complex Logic (MSI-2)		
CD4000B	CD4023UB	CD4009UB■	CD4070B	CD4006B	CD4051B■	CD4527B
CD4000UB	CD4025B	CD4010B■	CD4077B	CD4008B	CD4052B■	CD4532B
CD4001B	CD4025UB	CD4013B	CD4085B	CD4014B	CD4053B■	CD4536B
CD4001UB	CD4048B	CD4019B	CD4086B	CD4015B	CD4054B■	CD4538B
CD4002B	CD4066B■	CD4027B	CD4093B	CD4017B	CD4055B■	CD4541B
CD4002UB	CD4068B	CD4030B	CD4095B	CD4018B	CD4056B■	CD4543B
CD4007UB	CD4069UB	CD4041UB■	CD4096B	CD4020B	CD4060B	CD4555B
CD4011B	CD4071B	CD4042B	CD4098B	CD4021B	CD4063B	CD4556B
CD4011UB	CD4072B	CD4043B	CD4502B■	CD4022B	CD4067B■	CD4585B
CD4012B	CD4073B	CD4044B	CD4503B	CD4024B	CD4076B	CD4724B
CD4012UB	CD4075B	CD4047B	CD40106B	CD4026B	CD4089B	CD40100B
CD4016B■	CD4078B	CD4049UB■	CD40107B■	CD4028B	CD4094B	CD40101B
CD4023B	CD4081B	CD4050B■	CD40109B■	CD4029B	CD4097B■	CD40102B
	CD4082B		CD40174B	CD4031B	CD4099B	CD40103B
	CD40117B		CD40175B	CD4032B	CD4508B	CD40104B
			CD40257B	CD4033B	CD4510B	CD40105B
				CD4034B	CD4511B■	CD40108B
				CD4035B	CD4512B	CD40110B■
				CD4038B	CD4514B	CD40147B
				CD4040B	CD4515B	CD40160B
				CD4045B■	CD4516B	CD40161B
				CD4046B■	CD4517B	CD40162B
					CD4518B	CD40163B
					CD4520B	CD40181B
						CD40182B
						CD40192B
						CD40193B
						CD40194B
						CD40208B

■Indicates types for which, because of special design requirements, one or more static characteristics differ from the standardized data. Refer to RCA data pages on these types for specific differences.

RCA will supply both buffered ("B") and unbuffered ("UB") versions of the popular NOR and NAND gates to make available to designers the advantages of both. The chart below briefly compares the features of the two versions (a more detailed coverage of the special features of B- and UB-series CMOS gates is provided by ICAN-6558 in the Application-Notes section):

### 8. Reliability

RCA B-series CMOS integrated circuits incorporate the latest im-

provements in processing technology and plastic and ceramic packaging techniques. Product quality is real-time controlled using accelerated-temperature group quality screening in which measured dc parameters are criticized against tight B-series limits.

Figs. 7 through 10 show the standardized n- and p-channel drain characteristics for B-series CMOS devices, and Figs. 11 through 14 shows the normalized variation of output source and sink currents with respect to temperature and voltage in these devices.

Characteristic	Buffered Version ("B")	Unbuffered Version ("UB")
Propagation Delay (Speed)	Moderate	Fast
Noise Immunity/Margin	Excellent	Good
Output Impedance and Output Transition Time	Constant	Variable
AC Gain	High	Medium
Output Oscillation for Slow Inputs	Yes	No
Input Capacitance	Low	High

### B-Series Dynamic Electrical Characteristics

B-series dynamic electrical characteristics are specified for individual types under the following conditions:  $V_{DD} = 5V, 10V, \text{ and } 15V; T_A = 25^\circ C; C_L = 50 \text{ pF}; R_L = 200 \text{ k}\Omega; t_r \text{ and } t_f = 20 \text{ ns}$ . Table VIII lists dynamic characteristics specified for RCA B-series CMOS integrated circuits. Fig. 13 shows the variation of B-series dynamic parameters with temperature. Fig. 14 shows the variation of output transition time with supply voltage. Fig. 15 shows the variation of the standardized output transition time with load capacitance.

Maximum propagation delay or transition times for values of  $C_L$  other than the specified 50 picofarads can be determined by use of the multiplication factor (usually 2) between the typical and maximum values given in the dynamic characteristics chart included in the technical data for each device applied to the typical curves, and also shown in the device technical data.



# General Operating and Application Considerations

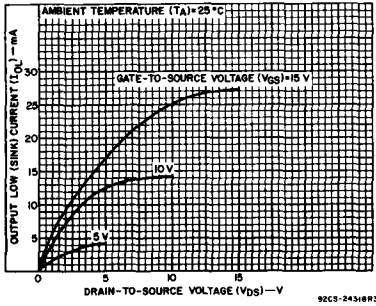

Fig. 7—Typical output low (sink) current characteristics.

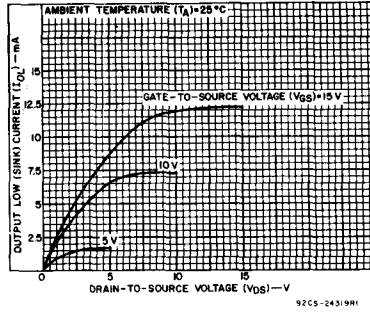

Fig. 8—Minimum output low (sink) current characteristics.

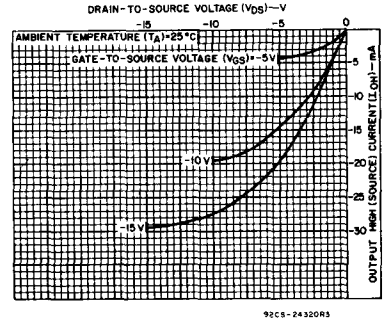

Fig. 9—Typical output high (source) current characteristics.

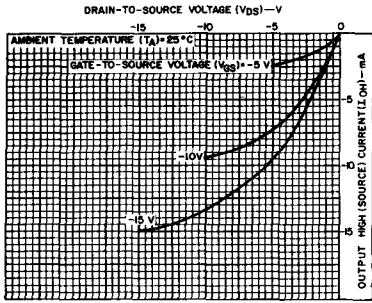

Fig. 10—Minimum output high (source) current characteristics.

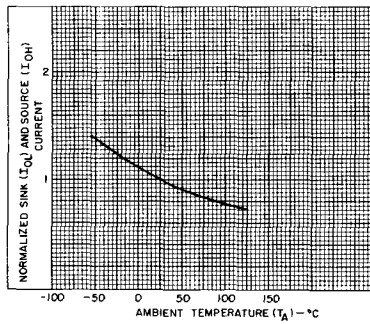

Fig. 11—Variation of normalized output low (sink) current  $I_{OL}$  and output high (source) current  $I_{OH}$  with temperature.

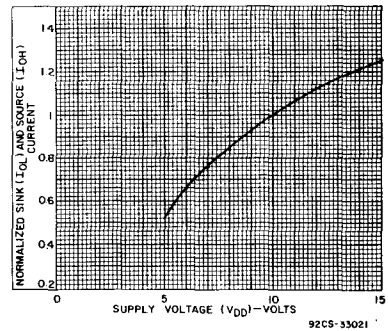

Fig. 12—Variation of normalized output low (sink) current  $I_{OL}$  and output high (source) current  $I_{OH}$  with supply voltage.

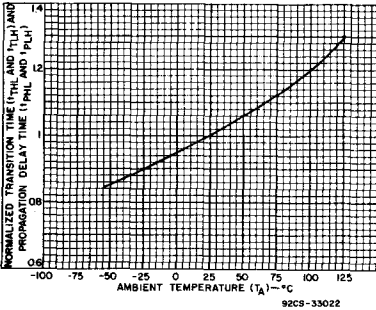

Fig. 13—Variation of low-to-high ( $t_{TLH}$ ) and high-to-low ( $t_{TLH}$ ) transition time, and low-to-high ( $t_{PLH}$ ) and high-to-low ( $t_{PLH}$ ) propagation delay time with temperature.

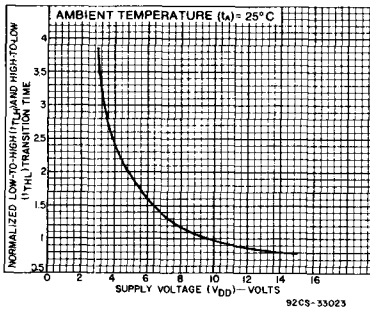

Fig. 14—Variation of low-to-high ( $t_{TLH}$ ) and high-to-low ( $t_{TLH}$ ) transition time with supply voltage.

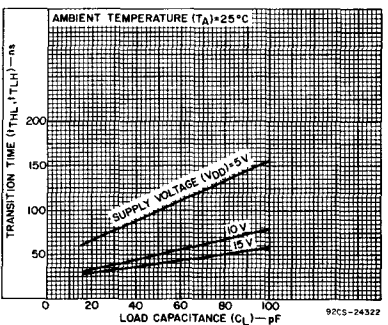

Fig. 15—Variation of transition time ( $t_{TLH}$ ,  $t_{TLH}$ ) with load capacitance.

## B-Series Dynamic (AC) Switching Parameters

Table VIII defines the major CMOS ac characteristics, with reference to the waveforms shown in Fig. 16 through 19. Test conditions of  $V_{DD}$ , low capacitance ( $C_L$ ), and input conditions are given for individual types in the published data.

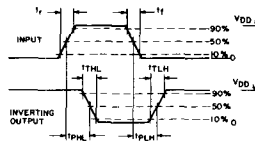

Fig. 16—Transition times and propagation delay times, combination logic.

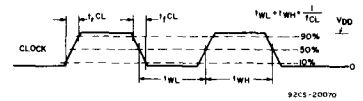

Fig. 17—Clock-pulse rise and fall times and pulse width.

Outputs should be switching from 10%  $V_{DD}$  to 90%  $V_{DD}$  in accordance with device truth table.

## General Operating and Application Considerations

Table VIII - Dynamic Electrical Characteristics - Definitions

Characteristic	Symbol	Limits		Notes
		Max.	Min.	
Propagation Delay: Outputs going high to low Outputs going low to high	$t_{PHL}$ $t_{PLH}$	X X		
Output Transition Time: Outputs going high to low Outputs going low to high	$t_{THL}$ $t_{TLH}$	X X		
Pulse Width-Set, Reset, Preset Enable, Disable, Strobe, Clock	$t_{WL}$ OR $t_{WH}$		X	1
Clock Input Frequency	$f_{CL}$	X		1,2
Clock Input Rise and Fall Time	$t_{rCL}, t_{fCL}$	X		
Set-Up Time	$t_{SU}$		X	1
Hold Time	$t_H$		X	1
Removal Time - Set, Reset, Preset-Enable	$t_{REM}$		X	1
Three State Disable Delay Times: High level to high impedance High impedance to low level Low level to high impedance High impedance to high level	$t_{PHZ}$ $t_{PZL}$ $t_{PLZ}$ $t_{PZH}$	X X X X		

- NOTE: (1) By placing a defining min. or max. in front of definition, the limits can change from min. to max., or vice versa.  
 (2) Clock input waveform should have a 50% duty cycle and be such as to cause the outputs to be switching from 10%  $V_{DD}$  to 90%  $V_{DD}$  in accordance with the device truth table.

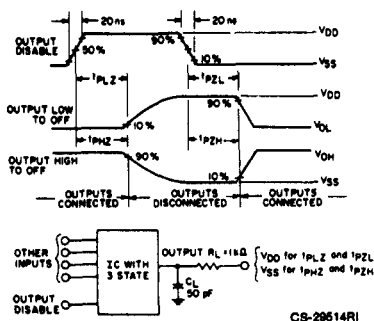

Fig. 18 - Three-state propagation delay wave shapes and test circuit.

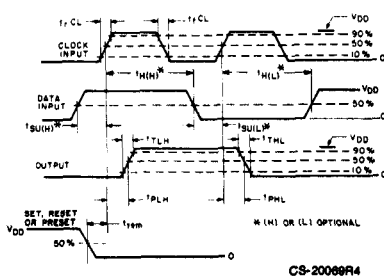

Fig. 19 - Setup times, hold times, removal time, and propagation delay times for positive-edge triggered sequential logic circuits.

### CMOS Special Products

RCA supplies a variety of special CMOS products that have operating supply-voltage ranges and other characteristics that differ from the standardized data specified for A- and B-series CMOS integrated circuits.

These special applications types include **flash A/D converters** for use in low-power consumption, high-speed digitization applications; **crosspoint switches** for use in telephone and PBX systems, in studio audio switching applications, and as multisystem bus interconnects; **tone generators** for use in dual-tone telephone dialing systems; **interface circuits** for level-shifting applications to interface CMOS logic levels with different logic types; and **display drivers** non-multiplexed, 4-digit, 7-segment LCD types containing all the circuitry necessary for driving conventional LCD displays without the need for external components.

---

# **CMOS High-Voltage B-Series Integrated Circuits**

## **Technical Data**

**3**

# CD4000B, CD4001B, CD4002B, CD4025B Types

## CMOS NOR Gates

High-Voltage Types (20-Volt Rating)

- Dual 3 Input plus Inverter – CD4000B
- Quad 2 Input – CD4001B
- Dual 4 Input – CD4002B
- Triple 3 Input – CD4025B

RCA-CD4000B, CD4001B, CD4002B, and CD4025B NOR gates provide the system designer with direct implementation of the NOR function and supplement the existing family of CMOS gates. All inputs and outputs are buffered.

The CD4000B, CD4001B, CD4002B, and CD4025B types are supplied in 14-lead hermetic dual-in-line ceramic packages (D and F suffixes), 14-lead dual-in-line plastic packages (E suffix), 14-lead ceramic flat packages (K suffix), and in chip form (H suffix).

### Features:

- Propagation delay time = 60 ns (typ.) at  $C_L = 50 \text{ pF}$ ,  $V_{DD} = 10 \text{ V}$
- Buffered inputs and outputs
- Standardized symmetrical output characteristics
- 100% tested for maximum quiescent current at 20 V
- 5-V, 10-V, and 15-V parametric ratings
- Maximum input current of  $1 \mu\text{A}$  at 18 V over full package-temperature range; 100 nA at 18 V and 25°C
- Noise margin (over full package temperature range):

1 V at  $V_{DD} = 5 \text{ V}$   
 2 V at  $V_{DD} = 10 \text{ V}$   
 2.5 V at  $V_{DD} = 15 \text{ V}$

- Meets all requirements of JEDEC Tentative Standard No. 13A, "Standard Specifications for Description of "B" Series CMOS Devices"

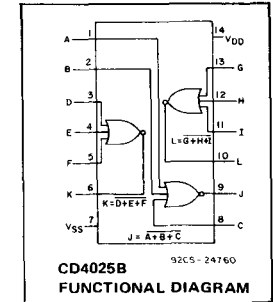
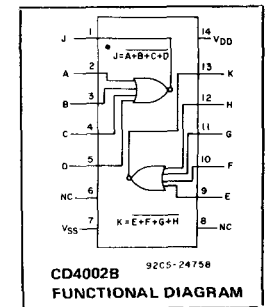
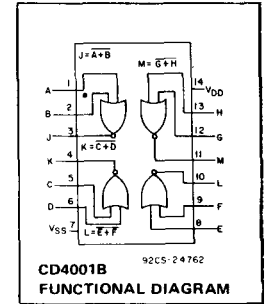
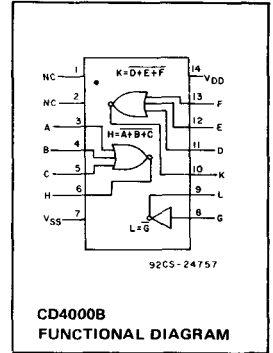

### STATIC ELECTRICAL CHARACTERISTICS

CHARACTERISTIC	CONDITIONS			LIMITS AT INDICATED TEMPERATURES (°C)							UNITS
	V <sub>O</sub> (V)	V <sub>IN</sub> (V)	V <sub>DD</sub> (V)	Values at -55, +25, +125 Apply to D,F,K,H Packages				Values at -40, +25, +85 Apply to E Package			
				-55	-40	+85	+125	+25			
								Min.	Typ.	Max.	
Quiescent Device Current, I <sub>DD</sub> Max.	-	0,5	5	0.25	0.25	7.5	7.5	-	0.01	0.25	μA
	-	0,10	10	0.5	0.5	15	15	-	0.01	0.5	
	-	0,15	15	1	1	30	30	-	0.01	1	
	-	0,20	20	5	5	150	150	-	0.02	5	
Output Low (Sink) Current I <sub>OL</sub> Min.	0.4	0,5	5	0.64	0.61	0.42	0.36	0.51	1	-	mA
	0.5	0,10	10	1.6	1.5	1.1	0.9	1.3	2.6	-	
	1.5	0,15	15	4.2	4	2.8	2.4	3.4	6.8	-	
Output High (Source) Current, I <sub>OH</sub> Min.	4.6	0,5	5	-0.64	-0.61	-0.42	-0.36	-0.51	-1	-	mA
	2.5	0,5	5	-2	-1.8	-1.3	-1.15	-1.6	-3.2	-	
	9.5	0,10	10	-1.6	-1.5	-1.1	-0.9	-1.3	-2.6	-	
	13.5	0,15	15	-4.2	-4	-2.8	-2.4	-3.4	-6.8	-	
Output Voltage: Low-Level, V <sub>OL</sub> Max.	-	0,5	5	0.05				-	0	0.05	V
	-	0,10	10	0.05				-	0	0.05	
	-	0,15	15	0.05				-	0	0.05	
Output Voltage: High-Level, V <sub>OH</sub> Min.	-	0,5	5	4.95				4.95	5	-	V
	-	0,10	10	9.95				9.95	10	-	
	-	0,15	15	14.95				14.95	15	-	
Input Low Voltage, V <sub>IL</sub> Max.	0.5, 4.5	-	5	1.5				-	-	1.5	V
	1.9	-	10	3				-	-	3	
	1.5, 13.5	-	15	4				-	-	4	
Input High Voltage, V <sub>IH</sub> Min.	0.5	-	5	3.5				3.5	-	-	V
	1	-	10	7				7	-	-	
	1.5	-	15	11				11	-	-	
Input Current I <sub>IN</sub> Max.		0,18	18	±0.1	±0.1	±1	±1	-	±10 <sup>-5</sup>	±0.1	μA

# CD4000B, CD4001B, CD4002B, CD4025B Types

## RECOMMENDED OPERATING CONDITIONS

For maximum reliability, nominal operating conditions should be selected so that operation is always within the following ranges:

CHARACTERISTIC	LIMITS		UNITS
	MIN.	MAX.	
Supply-Voltage Range (For $T_A$ = Full Package Temperature Range)	3	18	V

## MAXIMUM RATINGS, Absolute-Maximum Values:

DC SUPPLY-VOLTAGE RANGE, ( $V_{DD}$ ) (Voltages referenced to $V_{SS}$ Terminal)	-0.5 to +20 V
INPUT VOLTAGE RANGE, ALL INPUTS	-0.5 to $V_{DD} + 0.5$ V
DC INPUT CURRENT, ANY ONE INPUT	$\pm 10$ mA
POWER DISSIPATION PER PACKAGE ( $P_D$ ):	
For $T_A = -40$ to $+60^\circ\text{C}$ (PACKAGE TYPE E)	500 mW
For $T_A = +60$ to $+85^\circ\text{C}$ (PACKAGE TYPE E)	Derate Linearly at 12 mW/ $^\circ\text{C}$ to 200 mW
For $T_A = -55$ to $+100^\circ\text{C}$ (PACKAGE TYPES D, F, K)	500 mW
For $T_A = +100$ to $+125^\circ\text{C}$ (PACKAGE TYPES D, F, K)	Derate Linearly at 12 mW/ $^\circ\text{C}$ to 200 mW
DEVICE DISSIPATION PER OUTPUT TRANSISTOR	
FOR $T_A$ = FULL PACKAGE-TEMPERATURE RANGE (All Package Types)	100 mW
OPERATING-TEMPERATURE RANGE ( $T_A$ ):	
PACKAGE TYPES D, F, K, H	-55 to $+125^\circ\text{C}$
PACKAGE TYPE E	-40 to $+85^\circ\text{C}$
STORAGE TEMPERATURE RANGE ( $T_{stg}$ )	-65 to $+150^\circ\text{C}$
LEAD TEMPERATURE (DURING SOLDERING):	
At distance 1/16 $\pm$ 1/32 inch (1.59 $\pm$ 0.79 mm) from case for 10 s max.	$+265^\circ\text{C}$

## DYNAMIC ELECTRICAL CHARACTERISTICS

At  $T_A = 25^\circ\text{C}$ ; Input  $t_r, t_f = 20$  ns,  $C_L = 50$  pF,  $R_L = 200k\Omega$

CHARACTERISTIC	TEST CONDITIONS	ALL TYPES LIMITS		UNITS	
		$V_{DD}$ VOLTS	TYP.		MAX.
Propagation Delay Time, $t_{PHL}, t_{PLH}$		5	125	250	ns
		10	60	120	
		15	45	90	
Transition Time, $t_{THL}, t_{TLH}$		5	100	200	ns
		10	50	100	
		15	40	80	
Input Capacitance, $C_{iN}$	Any Input	5	7.5	pF	

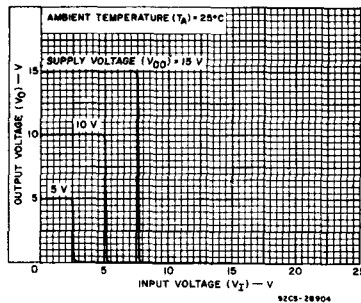

Fig. 1 - Typical voltage transfer characteristics.

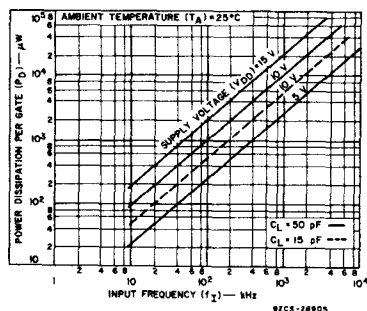

Fig. 2 - Typical power dissipation vs. frequency.

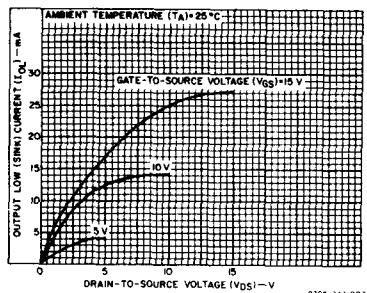

Fig. 3 - Typical output low (sink) current characteristics.

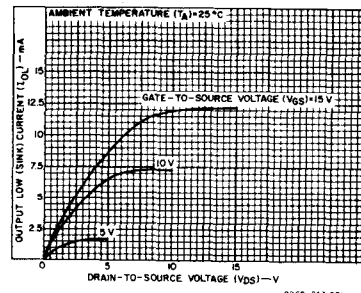

Fig. 5 - Minimum output low (sink) current characteristics.

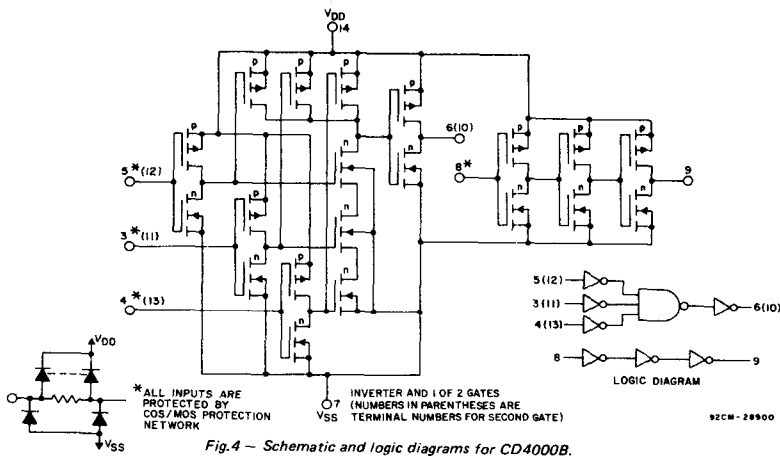

Fig. 4 - Schematic and logic diagrams for CD4000B.

# CD4000B, CD4001B, CD4002B, CD4025B Types

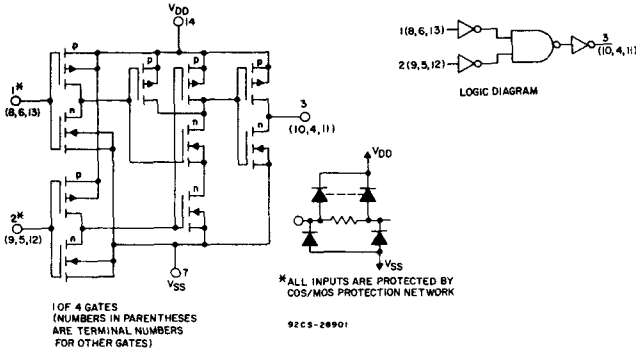

Fig.6 - Schematic and logic diagrams for CD4001B.

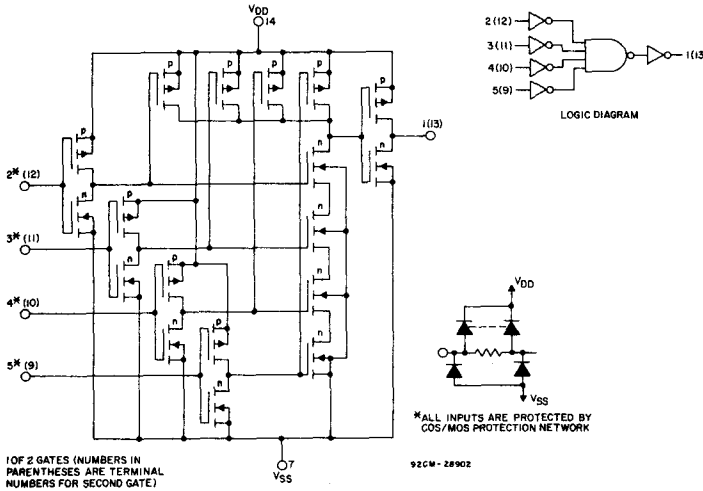

Fig.7 - Schematic and logic diagrams for CD4002B.

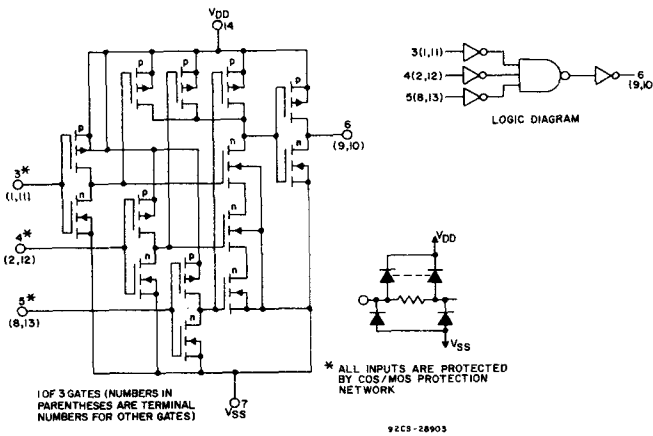

Fig.8 - Schematic and logic diagrams for CD4025B.

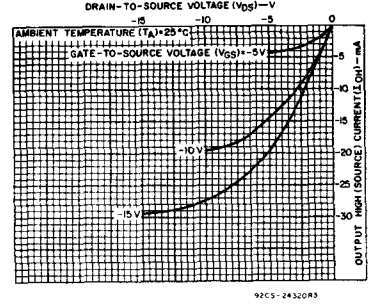

Fig.9 - Typical output high (source) current characteristics.

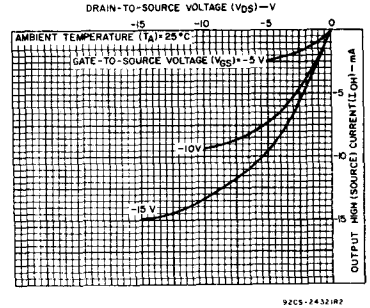

Fig.10 - Minimum output high (source) current characteristics.

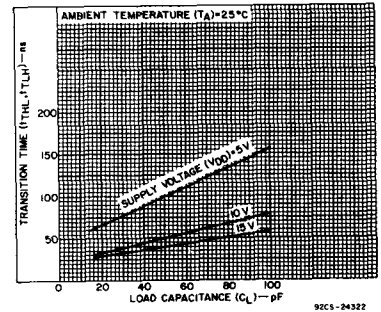

Fig.11 - Typical transition time vs. load capacitance.

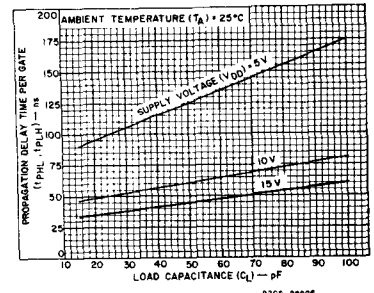

Fig.12 - Typical propagation delay time vs. load capacitance.

# CD4000B, CD4001B, CD4002B, CD4025B Types

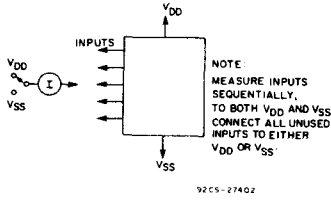

Fig. 13 - Input leakage current test circuit.

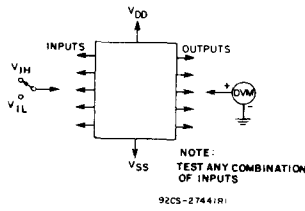

Fig. 14 - Input-voltage test circuit.

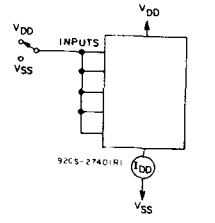
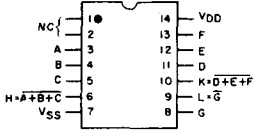

Fig. 15 - Quiescent-device current test circuit.

## TERMINAL ASSIGNMENTS (TOP VIEW)



NC=NO CONNECTION

CD4000B

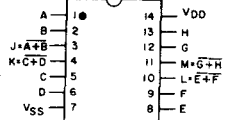

NC=NO CONNECTION

CD4001B

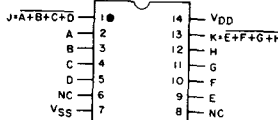

NC=NO CONNECTION

CD4002B

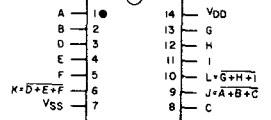

NC=NO CONNECTION

CD4025B

## CHIP PHOTOGRAPHS Dimensions and Pad Layouts

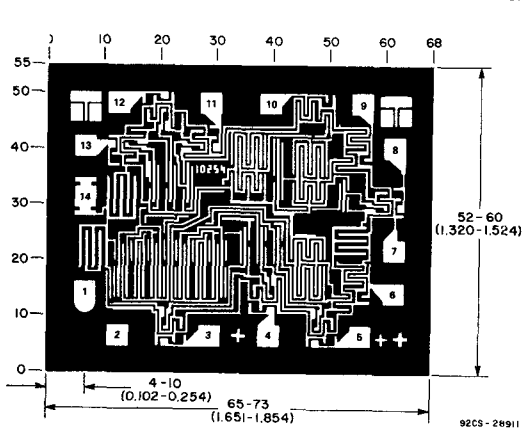

CD4000B

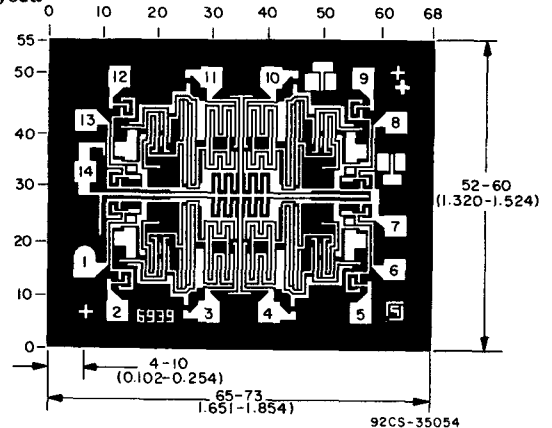

CD4001B

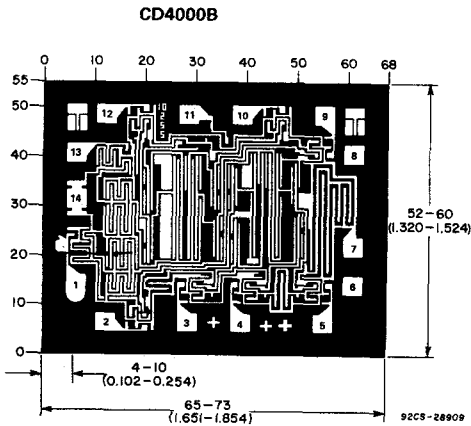

CD4002B

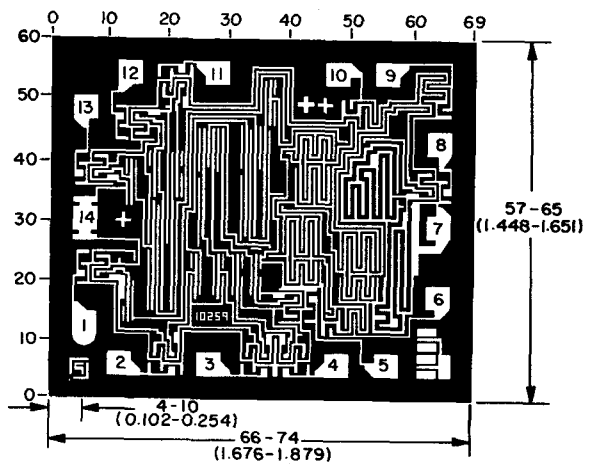

CD4025B

# CD4000UB, CD4001UB, CD4002UB, CD4025UB Types

## CMOS NOR Gates

High-Voltage Types (20-Volt Rating)  
Dual 3 Input  
plus Inverter—CD4000UB  
Quad 2 Input—CD4001UB  
Dual 4 Input—CD4002UB  
Triple 3 Input—CD4025UB

RCA-CD4000UB, CD4001UB, CD4002UB, and CD4025UB NOR gates provide the system designer with direct implementation of the NOR function and supplement the existing family of CMOS gates.

The CD4000UB, CD4001UB, CD4002UB, and CD4025UB types are supplied in 14-lead hermetic dual-in-line ceramic packages (D and F suffixes), 14-lead dual-in-line plastic packages (E suffix), 14-lead ceramic flat packages (K suffix), and in chip form (H suffix).

### Features:

- Propagation delay time = 30 ns (typ.) at  $C_L = 50$  pF,  $V_{DD} = 10$  V
- Standardized symmetrical output characteristics
- 100% tested for maximum quiescent current at 20 V
- Meets all requirements of JEDEC Tentative Standard No. 13A, "Standard Specifications for Description of 'B' Series CMOS Devices"
- Maximum input current of 1  $\mu$ A at 18 V over full package-temperature range; 100 nA at 18 V and 25°C
- 5-V, 10-V, and 15-V parametric ratings

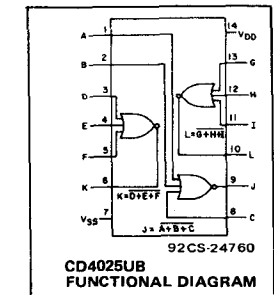
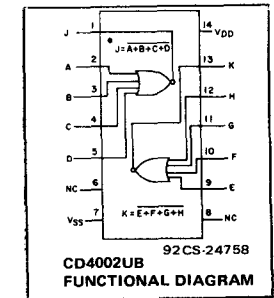
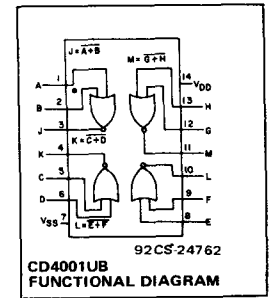
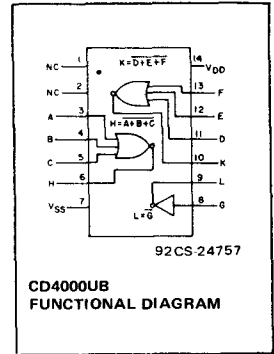

### STATIC ELECTRICAL CHARACTERISTICS

CHARACTER- ISTIC	CONDITIONS			LIMITS AT INDICATED TEMPERATURES (°C)							UNITS
	$V_D$ (V)	$V_{IN}$ (V)	$V_{DD}$ (V)	Values at -55, +25, +125 Apply to D, F, K, H Packages Values at -40, +25, +85 Apply to E Package							
				-55	-40	+85	+125	+25			
				Min.	Typ.	Max.					
Quiescent Device Current, $I_{DD}$ Max.	-	0.5	5	0.25	0.25	7.5	7.5	-	0.01	0.25	$\mu$ A
	-	0.10	10	0.5	0.5	15	15	-	0.01	0.5	
	-	0.15	15	1	1	30	30	-	0.01	1	
	-	0.20	20	5	5	150	150	-	0.02	5	
Output Low (Sink) Current $I_{OL}$ Min.	0.4	0.5	5	0.64	0.61	0.42	0.36	0.51	1	-	mA
	0.5	0.10	10	1.6	1.5	1.1	0.9	1.3	2.6	-	
	1.5	0.15	15	4.2	4	2.8	2.4	3.4	6.8	-	
Output High (Source) Current, $I_{OH}$ Min.	4.6	0.5	5	-0.64	-0.61	-0.42	-0.36	-0.51	-1	-	mA
	2.5	0.5	5	-2	-1.8	-1.3	-1.15	-1.6	-3.2	-	
	9.5	0.10	10	-1.6	-1.5	-1.1	-0.9	-1.3	-2.6	-	
	13.5	0.15	15	-4.2	-4	-2.8	-2.4	-3.4	-6.8	-	
Output Voltage: Low-Level, $V_{OL}$ Max.	-	0.5	5	0.05			-	0	0.05	V	
	-	0.10	10	0.05			-	0	0.05		
	-	0.15	15	0.05			-	0	0.05		
Output Voltage: High-Level, $V_{OH}$ Min.	-	0.5	5	4.95			4.95	5	-	V	
	-	0.10	10	9.95			9.95	10	-		
	-	0.15	15	14.95			14.95	15	-		
Input Low Voltage, $V_{IL}$ Max.	0.5, 4.5	-	5	1			-	-	1	V	
	1, 9	-	10	2			-	-	2		
	1.5, 13.5	-	15	2.5			-	-	2.5		
Input High Voltage, $V_{IH}$ Min.	0.5	-	5	4			4	-	-	V	
	1	-	10	8			8	-	-		
	1.5	-	15	12.5			12.5	-	-		
Input Current $I_{IN}$ Max.	-	0.18	18	$\pm 0.1$	$\pm 0.1$	$\pm 1$	$\pm 1$	-	$\pm 10^{-5}$	$\pm 0.1$	$\mu$ A



# CD4000UB, CD4001UB, CD4002UB, CD4025UB Types

## RECOMMENDED OPERATING CONDITIONS

For maximum reliability, nominal operating conditions should be selected so that operation is always within the following ranges:

CHARACTERISTIC	LIMITS		UNITS
	MIN.	MAX.	
Supply-Voltage Range (For $T_A$ = Full Package Temperature Range)	3	18	V

## MAXIMUM RATINGS, Absolute-Maximum Values:

DC SUPPLY-VOLTAGE RANGE, ( $V_{DD}$ ) (Voltages referenced to $V_{SS}$ Terminal)	-0.5 to +20 V
INPUT VOLTAGE RANGE, ALL INPUTS	-0.5 to $V_{DD}$ + 0.5 V
DC INPUT CURRENT, ANY ONE INPUT	$\pm 10$ mA
POWER DISSIPATION PER PACKAGE ( $P_D$ ):	
For $T_A$ = -40 to +60°C (PACKAGE TYPE E)	500 mW
For $T_A$ = +60 to +85°C (PACKAGE TYPE E)	Derate Linearly at 12 mW/°C to 200 mW
For $T_A$ = -55 to +100°C (PACKAGE TYPES D, F, K)	500 mW
For $T_A$ = +100 to +125°C (PACKAGE TYPES D, F, K)	Derate Linearly at 12 mW/°C to 200 mW
DEVICE DISSIPATION PER OUTPUT TRANSISTOR FOR $T_A$ = FULL PACKAGE-TEMPERATURE RANGE (All Package Types)	100 mW
OPERATING-TEMPERATURE RANGE ( $T_A$ ):	
PACKAGE TYPES D, F, K, H	-55 to +125°C
PACKAGE TYPE E	-40 to +85°C
STORAGE TEMPERATURE RANGE ( $T_{stg}$ )	-65 to +150°C
LEAD TEMPERATURE (DURING SOLDERING):	
At distance 1/16 $\pm$ 1/32 inch (1.59 $\pm$ 0.79 mm) from case for 10 s max.	+265°C

DYNAMIC ELECTRICAL CHARACTERISTICS at  $T_A = 25^\circ\text{C}$ , Input  $t_r, t_f = 20$  ns, and  $C_L = 50$  pF,  $R_L = 200$  K $\Omega$

CHARACTERISTIC	TEST CONDITIONS	ALL TYPES LIMITS		UNITS	
		$V_{DD}$ Volts	TYP.		MAX.
Propagation Delay Time, $t_{PHL}, t_{PLH}$		5	60	120	ns
		10	30	60	
		15	25	50	
Transition Time, $t_{THL}, t_{TLH}$		5	100	200	ns
		10	50	100	
		15	40	80	
Input Capacitance, $C_{IN}$	Any Input		10	15	pF

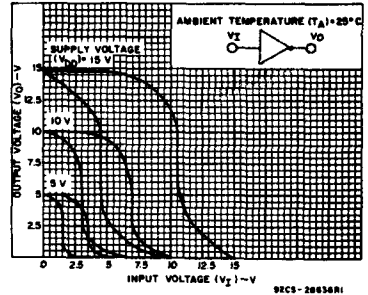

Fig. 1 - Minimum and maximum voltage transfer characteristics.

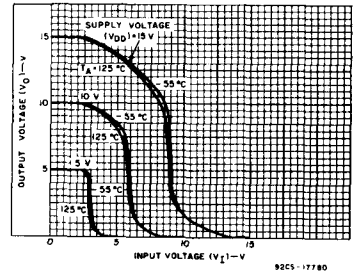

Fig. 2 - Typical voltage transfer characteristics as a function of temperature.

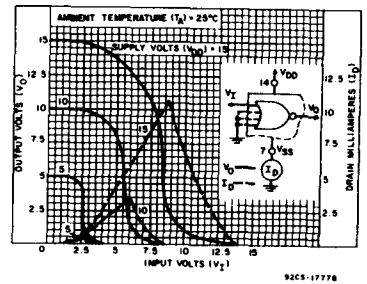

Fig. 3 - Typical current & voltage transfer characteristics.

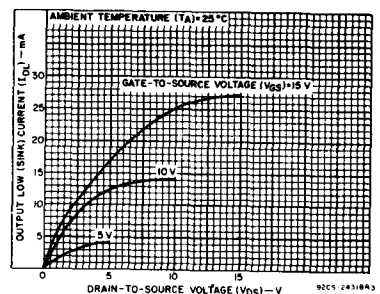

Fig. 5 - Typical output low (sink) current characteristics.

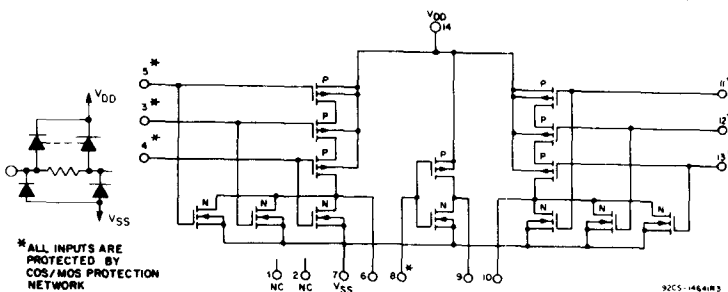

Fig. 4 - Schematic diagram for type CD4000UB.

# CD4000UB, CD4001UB, CD4002UB, CD4025UB Types

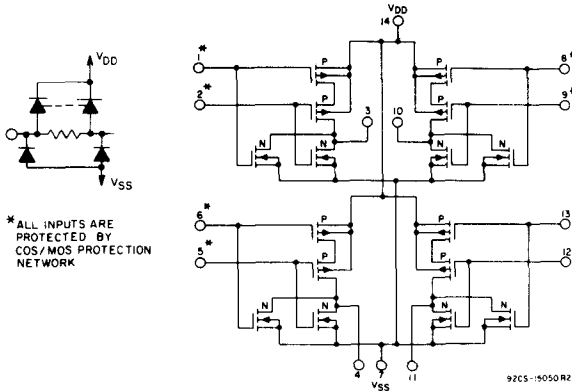

Fig. 6 - Schematic diagram for type CD4001UB.

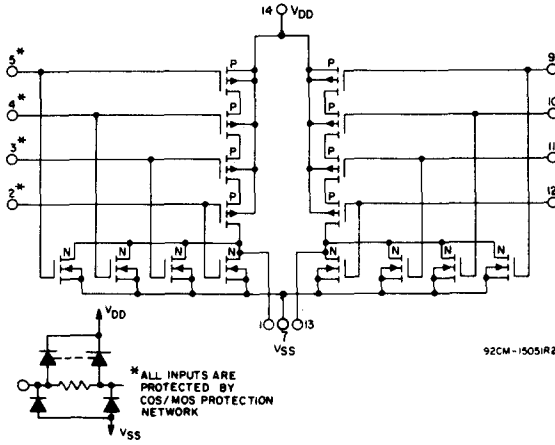

Fig. 7 - Schematic diagram for type CD4002UB.

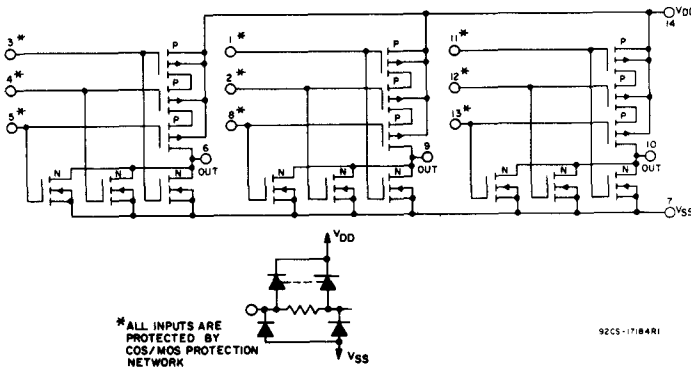

Fig. 8 - Schematic diagram for type CD4025UB.

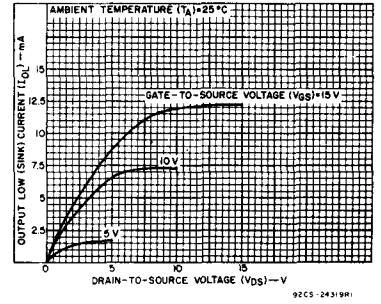

Fig. 9 - Minimum output low (sink) current characteristics.

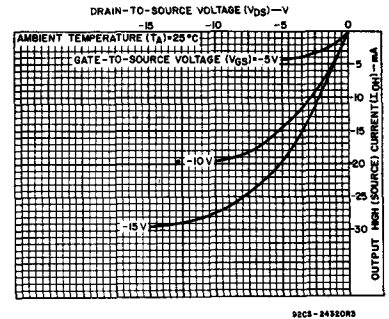

Fig. 10 - Typical output high (source) current characteristics.

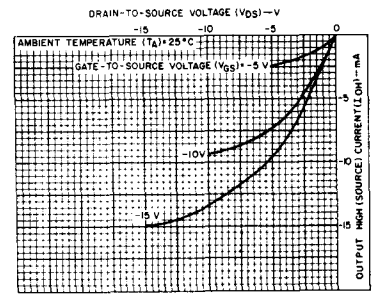

Fig. 11 - Minimum output high (source) current characteristics.

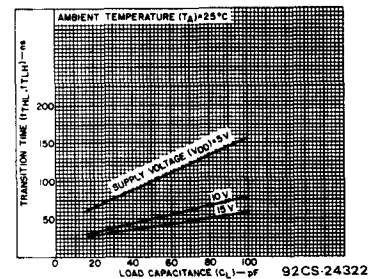

Fig. 12 - Typical transition time vs. load capacitance.

# CD4000UB, CD4001UB, CD4002UB, CD4025UB Types

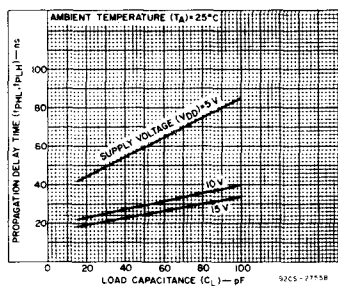

Fig. 13 - Typical propagation delay time vs. load capacitance.

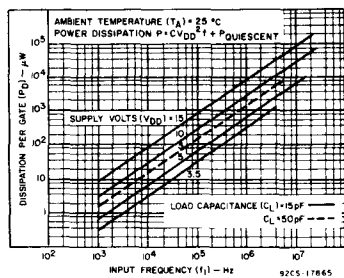

Fig. 14 - Typical power dissipation vs. frequency.

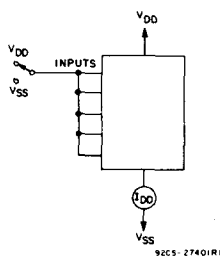

Fig. 15 - Quiescent device current test circuit.

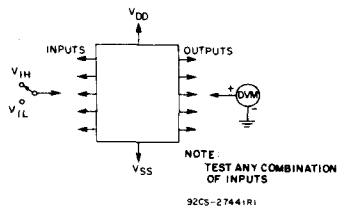

Fig. 16 - Input voltage test circuit.

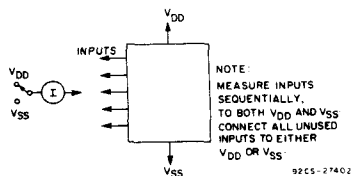
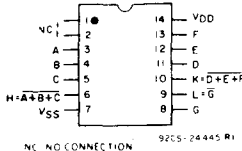
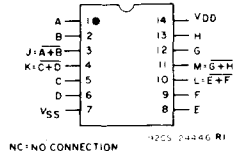

Fig. 17 - Input leakage current test circuit.

## TERMINAL ASSIGNMENTS



CD4000UB



CD4001UB

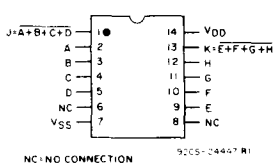

CD4002UB

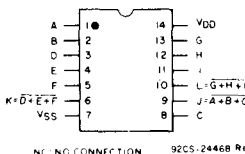

CD4025UB

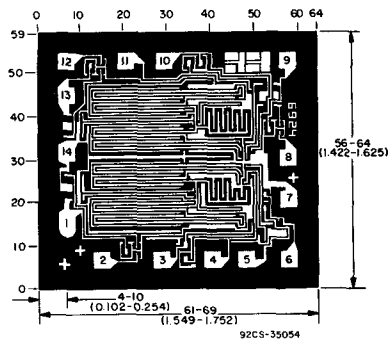

CD4001UB

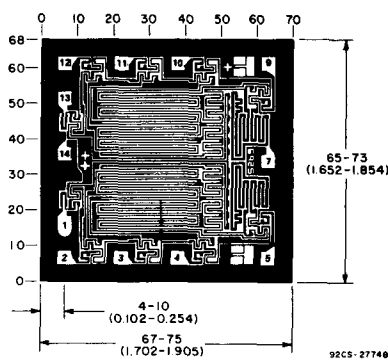

CD4002UB

## CHIP PHOTOGRAPHS Dimensions and Pad Layouts

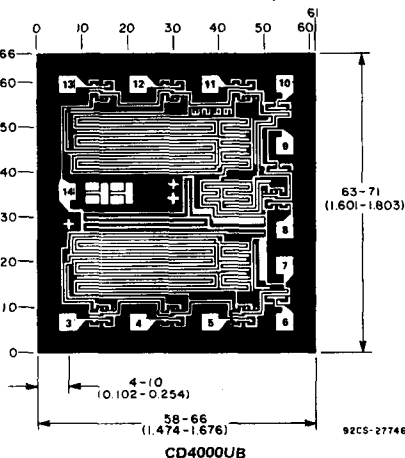

CD4000UB

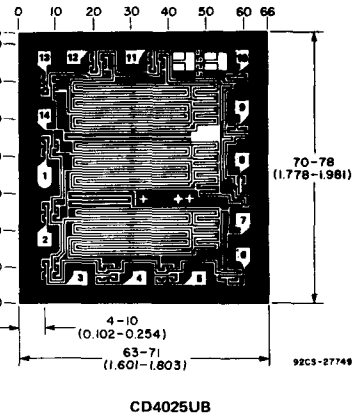

CD4025UB

Dimensions in parentheses are in millimeters and are derived from the basic inch dimensions as indicated. Grid graduations are in mils ( $10^{-3}$  inch).

The photographs and dimensions of each CMOS chip represent a chip when it is part of the wafer. When the wafer is separated into individual chips, the angle of cleavage may vary with respect to the chip face for different chips. The actual dimensions of the isolated chip, therefore, may differ slightly from the nominal dimensions shown. The user should consider a tolerance of  $\pm 9$  mils to  $\pm 16$  mils applicable to the nominal dimensions shown.

# CD4006B Types

## CMOS 18-Stage Static Shift Register

High-Voltage Types (20-Volt Rating)

The RCA-CD4006B types are composed of 4 separate shift register sections: two sections of four stages and two sections of five stages with an output tap at the fourth stage. Each section has an independent single-rail data path.

A common clock signal is used for all stages. Data are shifted to the next stage on negative-going transitions of the clock. Through appropriate connections of inputs and outputs, multiple register sections of 4, 5, 8, and 9 stages or single register sections of 10, 12, 13, 14, 16, 17 and 18 stages can be implemented using one CD4006B package. Longer shift register sections can be assembled by using more than one CD4006B.

To facilitate cascading stages when clock rise and fall times are slow, an optional output ( $D_1+4'$ ) that is delayed one-half clock-cycle, is provided (see Truth Table for Output from Term. 2).

The CD4006B types are supplied in 14-lead hermetic dual-in-line ceramic packages (D and F suffixes), 14-lead dual-in-line plastic packages (E suffix), 14-lead ceramic flat packages (K suffix), and in chip form (H suffix).

### Features:

- Fully static operation
- Shifting rates up to 12 MHz @ 10 V (typ.)
- Permanent register storage with clock line high or low — no information recirculation required
- 100% tested for quiescent current at 20 V
- Standardized, symmetrical output characteristics
- 5-V, 10-V, and 15-V parametric ratings
- Maximum input current of 1  $\mu$ A at 18 V over full package-temperature range; 100 nA at 18 V and 25°C
- Noise margin (full package-temperature range) =
  - 1 V at  $V_{DD} = 5$  V
  - 2 V at  $V_{DD} = 10$  V
  - 2.5 V at  $V_{DD} = 15$  V
- Meets all requirements of JEDEC Tentative Standard No. 13A, "Standard Specifications for Description of 'B' Series CMOS Devices"

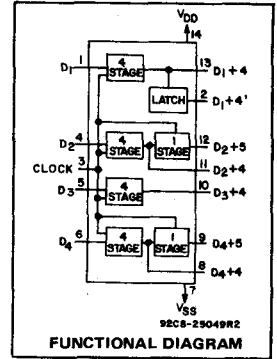

### Applications:

- Serial shift registers
- F frequency division
- Time delay circuits

TRUTH TABLE FOR SHIFT REGISTER STAGE

D	CL <sup>▲</sup>	D + 1
0		0
1		1
X		NC

TRUTH TABLE FOR OUTPUT FROM TERM2

$D_1+4$	CL <sup>▲</sup>	$D_1+4'$
0		0
1		1
X		NC

1 = HIGH      X = DON'T CARE  
 0 = LOW      ▲ = LEVEL CHANGE  
 NC = NO CHANGE

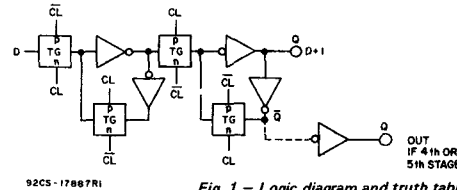
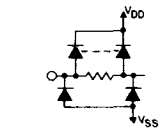
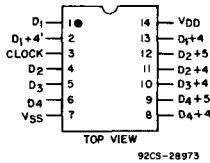

Fig. 1 - Logic diagram and truth table (one register stage).

### TERMINAL ASSIGNMENT



ALL INPUTS (TERMINALS 1, 3, 4, 5, 6) PROTECTED BY COS/MOS PROTECTION NETWORK

RECOMMENDED OPERATING CONDITIONS at  $T_A = 25^\circ\text{C}$ , Except as Noted. For maximum reliability, nominal operating conditions should be selected so that operation is always within the following ranges:

CHARACTERISTIC	$V_{DD}$ (V)	LIMITS		UNITS
		Min.	Max.	
Supply-Voltage Range (For $T_A =$ Full Package Temperature Range)	—	3	18	V
Clock Pulse Width, $t_{W}$	5	180	—	ns
	10	80	—	
	15	50	—	
Data Setup Time, $t_S$	5	100	—	ns
	10	50	—	
	15	40	—	
Data Hold Time, $t_H$	5	60	—	ns
	10	40	—	
	15	30	—	
Clock Rise or Fall Time: $t_r, t_f$	5, 10,	—	15	$\mu$ S
	15	—	—	
Clock Input Frequency, $f_{CL}$	5	—	2.5	MHz
	10	—	5	
	15	—	7	

# CD4006B Types

## MAXIMUM RATINGS, Absolute-Maximum Values:

DC SUPPLY-VOLTAGE RANGE, ( $V_{DD}$ ) (Voltages referenced to $V_{SS}$ Terminal)	-0.5 to +20 V
INPUT VOLTAGE RANGE, ALL INPUTS	-0.5 to $V_{DD} + 0.5$ V
DC INPUT CURRENT, ANY ONE INPUT	$\pm 10$ mA
POWER DISSIPATION PER PACKAGE ( $P_D$ ):	
For $T_A = -40$ to $+60^\circ\text{C}$ (PACKAGE TYPE E)	500 mW
For $T_A = +60$ to $+85^\circ\text{C}$ (PACKAGE TYPE E)	Derate Linearly at $12\text{ mW}/^\circ\text{C}$ to 200 mW
For $T_A = -55$ to $+100^\circ\text{C}$ (PACKAGE TYPES D, F, K)	500 mW
For $T_A = +100$ to $+125^\circ\text{C}$ (PACKAGE TYPES D, F, K)	Derate Linearly at $12\text{ mW}/^\circ\text{C}$ to 200 mW
DEVICE DISSIPATION PER OUTPUT TRANSISTOR	
FOR $T_A = \text{FULL PACKAGE-TEMPERATURE RANGE (All Package Types)}$	100 mW
OPERATING-TEMPERATURE RANGE ( $T_A$ ):	
PACKAGE TYPES D, F, K, H	$-55$ to $+125^\circ\text{C}$
PACKAGE TYPE E	$-40$ to $+85^\circ\text{C}$
STORAGE TEMPERATURE RANGE ( $T_{stg}$ )	$-65$ to $+150^\circ\text{C}$
LEAD TEMPERATURE (DURING SOLDERING):	
At distance $1/16 \pm 1/32$ inch ( $1.59 \pm 0.79$ mm) from case for 10 s max.	$+265^\circ\text{C}$

## STATIC ELECTRICAL CHARACTERISTICS

CHARACTERISTIC	CONDITIONS			LIMITS AT INDICATED TEMPERATURES ( $^\circ\text{C}$ )							UNITS
				Values at $-55, +25, +125$ Apply to D, F, K, H Packages Values at $-40, +25, +85$ Apply to E Package							
	$V_O$ (V)	$V_{IN}$ (V)	$V_{DD}$ (V)	-55	-40	+85	+125	+25			
								Min.	Typ.	Max.	
Quiescent Device Current, $I_{DD}$ Max.	-	0.5	5	5	5	150	150	-	0.04	5	$\mu\text{A}$
	-	0.10	10	10	10	300	300	-	0.04	10	
	-	0.15	15	20	20	600	600	-	0.04	20	
	-	0.20	20	100	100	3000	3000	-	0.08	100	
Output Low (Sink) Current $I_{OL}$ Min.	0.4	0.5	5	0.64	0.61	0.42	0.36	0.51	1	-	$\text{mA}$
	0.5	0.10	10	1.6	1.5	1.1	0.9	1.3	2.6	-	
	1.5	0.15	15	4.2	4	2.8	2.4	3.4	6.8	-	
Output High (Source) Current, $I_{OH}$ Min.	4.6	0.5	5	-0.64	-0.61	-0.42	-0.36	-0.51	-1	-	$\text{mA}$
	2.5	0.5	5	-2	-1.8	-1.3	-1.15	-1.6	-3.2	-	
	9.5	0.10	10	-1.6	-1.5	-1.1	-0.9	-1.3	-2.6	-	
	13.5	0.15	15	-4.2	-4	-2.8	-2.4	-3.4	-6.8	-	
Output Voltage: Low-Level, $V_{OL}$ Max.	-	0.5	5			0.05		-	0	0.05	V
	-	0.10	10			0.05		-	0	0.05	
	-	0.15	15			0.05		-	0	0.05	
Output Voltage: High-Level, $V_{OH}$ Min.	-	0.5	5			4.95		4.95	5	-	V
	-	0.10	10			9.95		9.95	10	-	
	-	0.15	15			14.95		14.95	15	-	
Input Low Voltage, $V_{IL}$ Max.	0.5, 4.5	-	5			1.5		-	-	1.5	V
	1, 9	-	10			3		-	-	3	
	1.5, 13.5	-	15			4		-	-	4	
Input High Voltage, $V_{IH}$ Min.	0.5, 4.5	-	5			3.5		3.5	-	-	V
	1, 9	-	10			7		7	-	-	
	1.5, 13.5	-	15			11		11	-	-	
Input Current $I_{IN}$ Max.	-	0.18	18	$\pm 0.1$	$\pm 0.1$	$\pm 1$	$\pm 1$	-	$\pm 10^{-5}$	$\pm 0.1$	$\mu\text{A}$

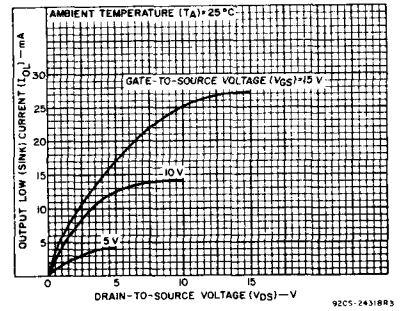

Fig. 2 - Typical output low (sink) current characteristics.

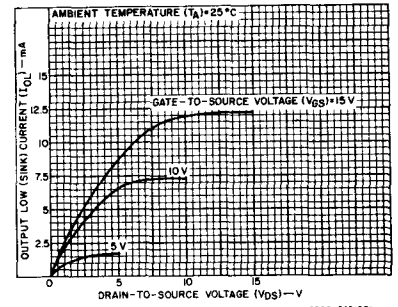

Fig. 3 - Minimum output low (sink) current characteristics.

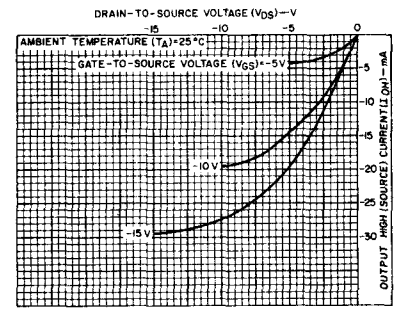

Fig. 4 - Typical output high (source) current characteristics.

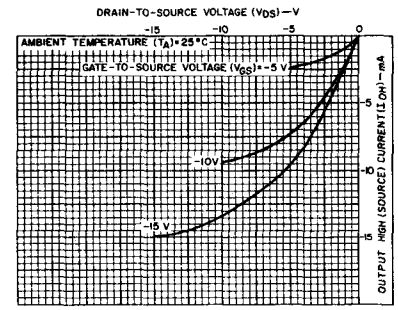

Fig. 5 - Minimum output high (source) current characteristics.

# CD4006B Types

DYNAMIC ELECTRICAL CHARACTERISTICS at  $T_A = 25^\circ\text{C}$ ; Input  $t_r, t_f = 20\text{ ns}$ ,  
 $C_L = 50\text{ pF}$ ,  $R_L = 200\text{ K}\Omega$

CHARACTERISTIC	TEST CONDITIONS $V_{DD}$ (V)	TYPICAL VALUES	UNITS
Propagation Delay Time, $t_{PHL}, t_{PLH}$	5 10 15	200 100 80	ns
Transition Time, $t_{THL}, t_{TLH}$	5 10 15	100 50 40	ns
Minimum Data Setup Time, $t_S$	5 10 15	50 25 20	ns
Minimum Clock Pulse Width, $t_W$	5 10 15	100 45 30	ns
Maximum Clock Input Frequency, $f_{CL}$	5 10 15	5 12 16	MHz
Maximum Clock Input Rise or Fall Time $t_{rCL}, t_{fCL}^*$	5 10 15	15 15 15	$\mu\text{s}$
Input Capacitance, $C_{IN}$	Any Input	5	pF

\* If more than one unit is cascaded  $t_{rCL}$  should be made less than or equal to the sum of the transition time and the fixed propagation delay of the output of the driving stage for the estimated capacitive load.

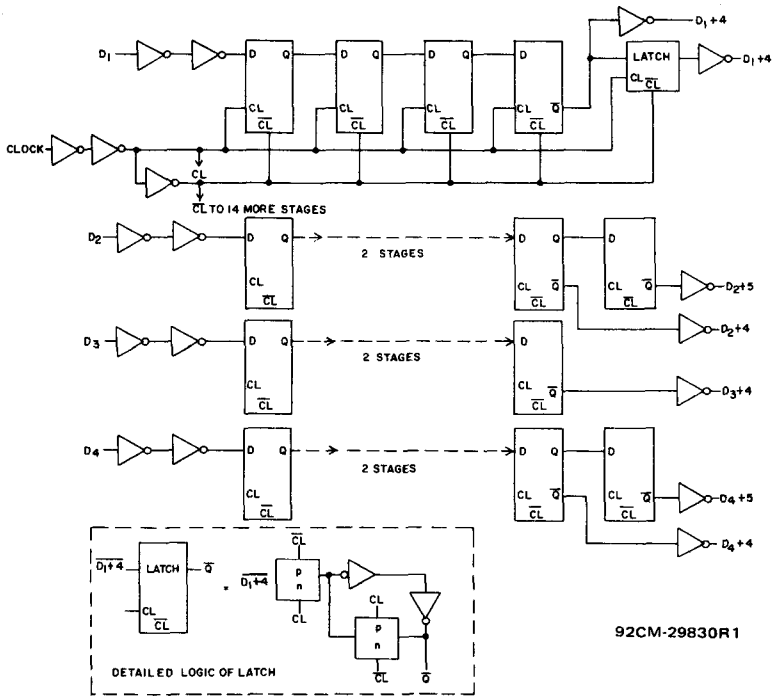

Fig. 6 - Logic diagram with detail of latch.

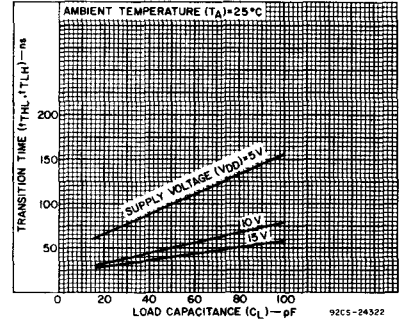

Fig. 7 - Typical transition time as a function of load capacitance.

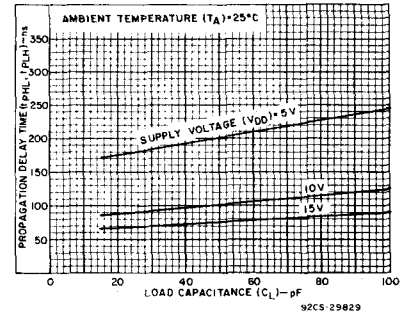

Fig. 8 - Typical propagation delay time as a function of load capacitance.

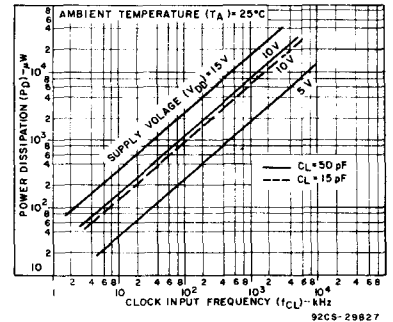

Fig. 9 - Typical dynamic power dissipation as a function of clock frequency.

# CD4006B Types

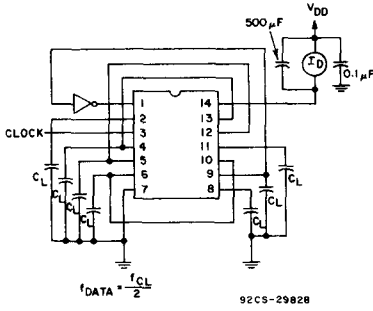

Fig. 10 - Dynamic power dissipation test circuit.

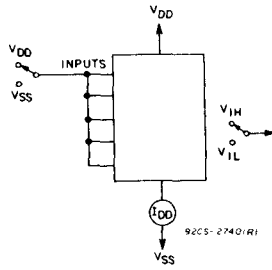

Fig. 11 - Quiescent device current test circuit.

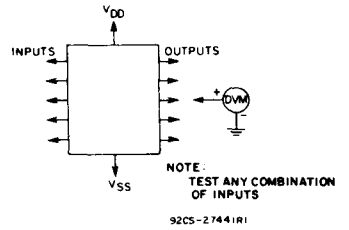

Fig. 12 - Input voltage test circuit.

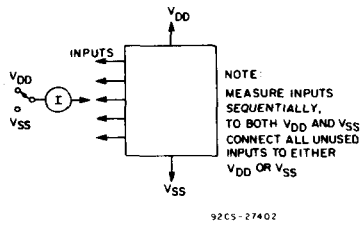
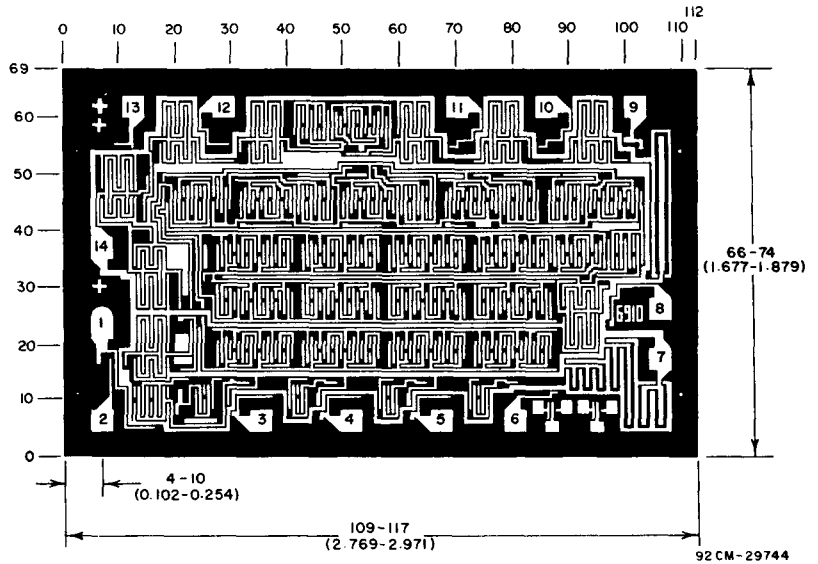

Fig. 13 - Input current test circuit.



Dimensions in parentheses are in millimeters and are derived from the basic inch dimensions as indicated. Grid graduations are in mils ( $10^{-3}$  inch).

The photographs and dimensions of each CMOS chip represent a chip when it is part of the wafer. When the wafer is separated into individual chips, the angle of cleavage may vary with respect to the chip face for different chips. The actual dimensions of the isolated chip, therefore, may differ slightly from the nominal dimensions shown. The user should consider a tolerance of  $-3$  mils to  $+16$  mils applicable to the nominal dimensions shown.

Dimensions and pad layout for CD4006BH.

# CD4007UB Types

## CMOS Dual Complementary Pair Plus Inverter

High-Voltage Types (20-Volt Rating)

The RCA-CD4007UB types are comprised of three n-channel and three p-channel enhancement-type MOS transistors. The transistor elements are accessible through the package terminals to provide a convenient means for constructing the various typical circuits as shown in Fig. 2.

More complex functions are possible using multiple packages. Numbers shown in parentheses indicate terminals that are connected together to form the various configurations listed.

The CD4007UB types are supplied in 14-lead hermetic dual-in-line ceramic packages (D and F suffixes), 14-lead dual-in-line plastic packages (E suffix), 14-lead ceramic flat packages (K suffix), and in chip form (H suffix).

### Applications:

- Extremely high-input impedance amplifiers
- Shapers
- Inverters
- Threshold detector
- Linear amplifiers
- Crystal oscillators

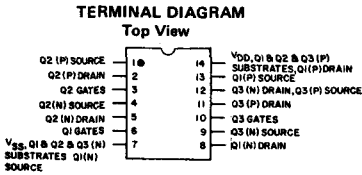

### Features:

- Standardized symmetrical output characteristics
- Medium Speed Operation —  $t_{PHL}$ ,  $t_{PLH}$  = 30 ns (typ.) at 10 V
- 100% tested for quiescent current at 20 V
- Meets all requirements of JEDEC Tentative Standard No. 13A, "Standard Specifications for Description of 'B' Series CMOS Devices"
- Maximum input current of 1  $\mu$ A at 18 V over full package-temperature range; 100 nA at 18 V and 25°C

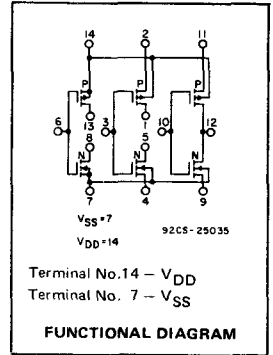

### RECOMMENDED OPERATING CONDITIONS

For maximum reliability, nominal operating conditions should be selected so that operation is always within the following ranges:

CHARACTERISTIC	LIMITS		UNITS
	MIN.	MAX.	
Supply-Voltage Range (For $T_A$ = Full Package Temperature Range)	3	18	V

### STATIC ELECTRICAL CHARACTERISTICS

CHARACTERISTIC	CONDITIONS			LIMITS AT INDICATED TEMPERATURES (°C)						UNITS	
	$V_O$ (V)	$V_{IN}$ (V)	$V_{DD}$ (V)	Values at -55, +25, +125 Apply to D, F, K, H Packages Values at -40, +25, +85 Apply to E Package				+25			
				-55	-40	+85	+125	Min.	Typ.		Max.
Quiescent Device Current, $I_{DD}$ Max.	—	0,5	5	0,25	0,25	7,5	7,5	—	0,01	0,25	$\mu$ A
	—	0,10	10	0,5	0,5	15	15	—	0,01	0,5	
	—	0,15	15	1	1	30	30	—	0,01	1	
	—	0,20	20	5	5	150	150	—	0,02	5	
Output Low (Sink) Current $I_{OL}$ Min.	0,4	0,5	5	0,64	0,61	0,42	0,36	0,51	1	—	mA
	0,5	0,10	10	1,6	1,5	1,1	0,9	1,3	2,6	—	
	1,5	0,15	15	4,2	4	2,8	2,4	3,4	6,8	—	
Output High (Source) Current, $I_{OH}$ Min.	4,6	0,5	5	-0,64	-0,61	-0,42	-0,36	-0,51	-1	—	mA
	2,5	0,5	5	-2	-1,8	-1,3	-1,15	-1,6	-3,2	—	
	9,5	0,10	10	-1,6	-1,5	-1,1	-0,9	-1,3	-2,6	—	
Output Voltage: Low-Level, $V_{OL}$ Max.	—	0,5	5	0,05				—	0	0,05	V
	—	0,10	10	0,05				—	0	0,05	
	—	0,15	15	0,05				—	0	0,05	
Output Voltage: High-Level, $V_{OH}$ Min.	—	0,5	5	4,95				4,95	5	—	V
	—	0,10	10	9,95				9,95	10	—	
	—	0,15	15	14,95				14,95	15	—	
Input Low Voltage, $V_{IL}$ Max.	4,5	—	5	1				—	—	1	V
	9	—	10	2				—	—	2	
	13,5	—	15	2,5				—	—	2,5	
Input High Voltage, $V_{IH}$ Min.	0,5	—	5	4				4	—	—	V
	1	—	10	8				8	—	—	
	1,5	—	15	12,5				12,5	—	—	
Input Current $I_{IN}$ Max.		0,18	18	$\pm 0,1$	$\pm 0,1$	$\pm 1$	$\pm 1$	—	$\pm 10^{-5}$	$\pm 0,1$	$\mu$ A



# CD4007UB Types

## MAXIMUM RATINGS, Absolute-Maximum Values:

DC SUPPLY-VOLTAGE RANGE, ( $V_{DD}$ ) (Voltages referenced to $V_{SS}$ Terminal)	-0.5 to +20 V
INPUT VOLTAGE RANGE, ALL INPUTS	-0.5 to $V_{DD} + 0.5$ V
DC INPUT CURRENT, ANY ONE INPUT	$\pm 10$ mA
POWER DISSIPATION PER-PACKAGE ( $P_D$ ):	
For $T_A = -40$ to $+60^\circ\text{C}$ (PACKAGE TYPE E)	500 mW
For $T_A = +60$ to $+85^\circ\text{C}$ (PACKAGE TYPE E)	Derate Linearly at 12 mW/ $^\circ\text{C}$ to 200 mW
For $T_A = -55$ to $+100^\circ\text{C}$ (PACKAGE TYPES D, F, K)	500 mW
For $T_A = +100$ to $+125^\circ\text{C}$ (PACKAGE TYPES D, F, K)	Derate Linearly at 12 mW/ $^\circ\text{C}$ to 200 mW
DEVICE DISSIPATION PER OUTPUT TRANSISTOR	
FOR $T_A = \text{FULL PACKAGE-TEMPERATURE RANGE}$ (All Package Types)	100 mW
OPERATING-TEMPERATURE RANGE ( $T_A$ ):	
PACKAGE TYPES D, F, K, H	$-55$ to $+125^\circ\text{C}$
PACKAGE TYPE E	$-40$ to $+85^\circ\text{C}$
STORAGE TEMPERATURE RANGE ( $T_{stg}$ )	$-65$ to $+150^\circ\text{C}$
LEAD TEMPERATURE (DURING SOLDERING):	
At distance $1/16 \pm 1/32$ inch ( $1.59 \pm 0.79$ mm) from case for 10 s max.	$+265^\circ\text{C}$

DYNAMIC ELECTRICAL CHARACTERISTICS at  $T_A = 25^\circ\text{C}$ ; Input  $t_r, t_f = 20$  ns,  
 $C_L = 50$  pF,  $R_L = 200$  K $\Omega$

CHARACTERISTIC	CONDITIONS	ALL TYPES LIMITS		UNITS	
		$V_{DD}$ Volts	Typ.		Max.
Propagation Delay Time: $t_{PHL}$ , $t_{PLH}$		5	55	110	ns
		10	30	60	
		15	25	50	
Transition Time $t_{THL}$ , $t_{TLH}$		5	100	200	ns
		10	50	100	
		15	40	80	
Input Capacitance	$C_{IN}$	Any Input	10	15	pF

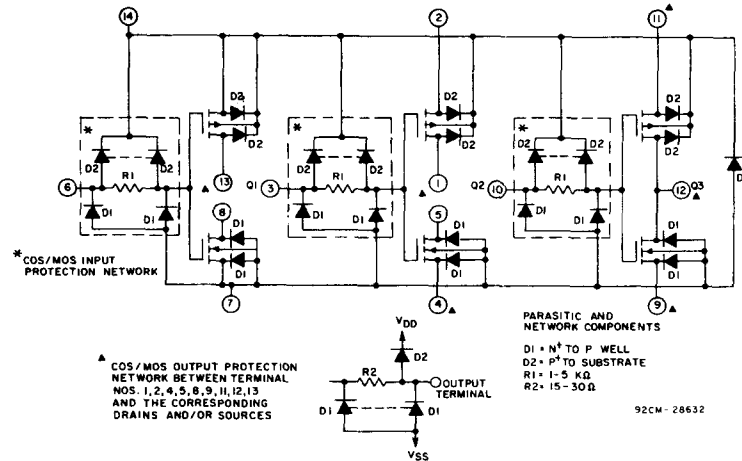
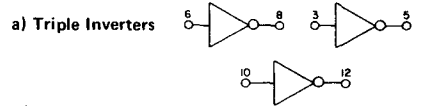
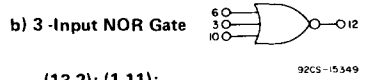

Fig. 1 - Detailed schematic diagram of CD4007UB showing input, output, and parasitic diodes.



(14,2,11); (8,13);  
(1,5); (7,4,9)



(13,2); (1,11);  
(12,5,8); (7,4,9)



(1,12,13); (2,14,11);  
(4,8); (5,9)

## d) Tree (Relay) Logic

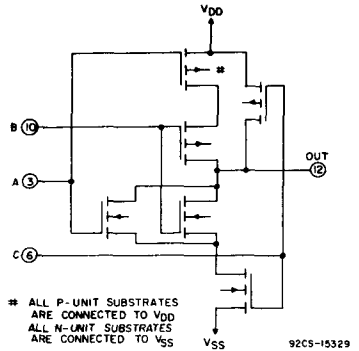

# ALL P-UNIT SUBSTRATES  
ARE CONNECTED TO  $V_{DD}$   
ALL N-UNIT SUBSTRATES  
ARE CONNECTED TO  $V_{SS}$

(13,12,5); (4,9,8);  
(14,2); (1,11)

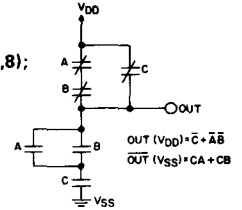

Fig. 2 - Sample COS/MOS logic circuit arrangements using type CD4007UB.

# CD4007UB Types

## e) High Sink-Current Driver

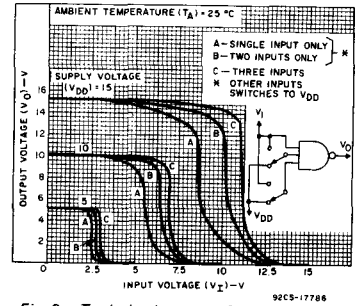
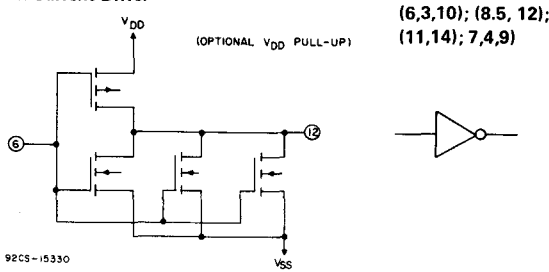

Fig. 3 - Typical voltage-transfer characteristics for NAND gate.

## f) High Source-Current Driver

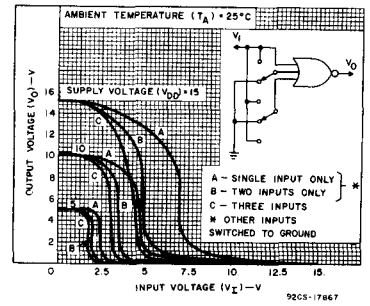
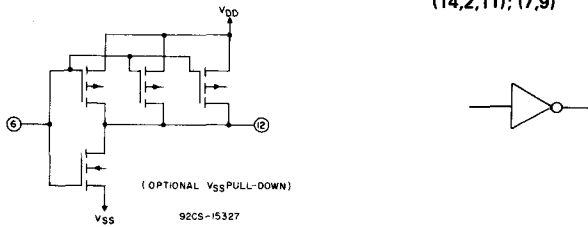
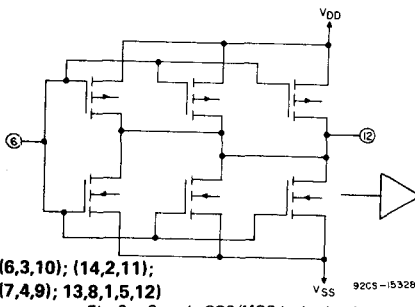

Fig. 4 - Typical voltage-transfer characteristics for NOR gate.

## g) High Sink - and Source-Current Driver



## h) Dual Bi-Directional Transmission Gating

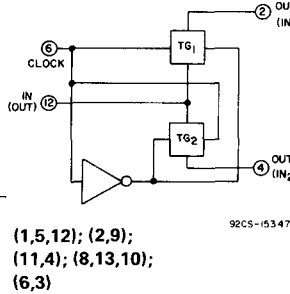

Fig. 2 - Sample COS/MOS logic circuit arrangements using type CD4007UB (Cont'd).

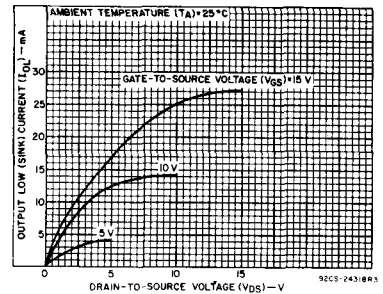

Fig. 5 - Typical output low (sink) current characteristics.

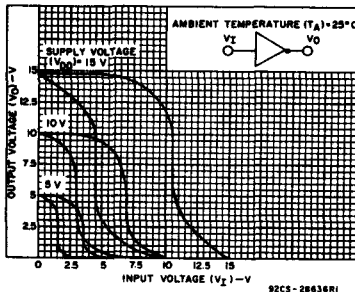

Fig. 6 - Minimum and maximum voltage-transfer characteristics for inverter.

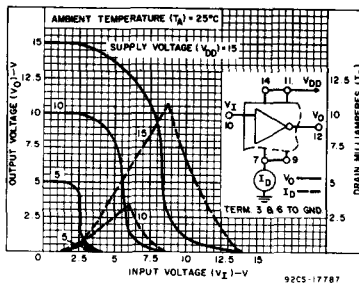

Fig. 7 - Typical current and voltage-transfer characteristics for inverter.

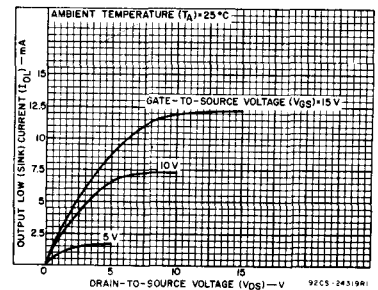

Fig. 8 - Minimum output low (sink) current characteristics.

# CD4007UB Types

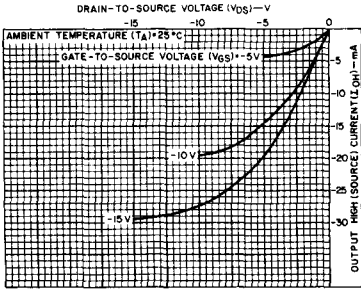

Fig. 9 - Typical output high (source) current characteristics.

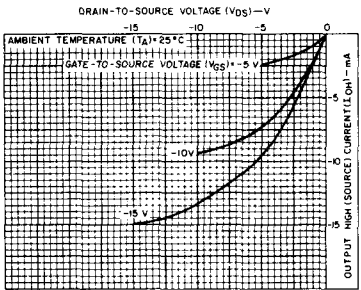

Fig. 10 - Minimum output high (source) current characteristics.

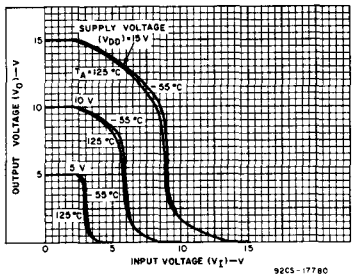

Fig. 11 - Typical voltage-transfer characteristics as a function of temperature.

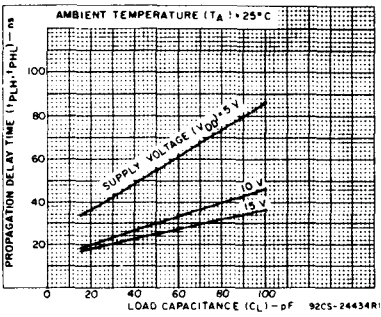

Fig. 12 - Typical propagation delay time vs. load capacitance.

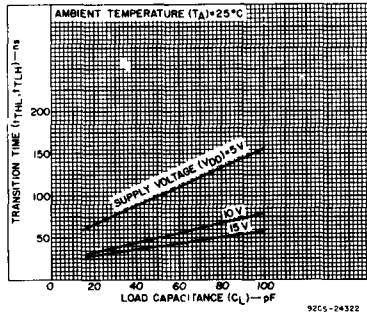

Fig. 13 - Typical transition time vs. load capacitance.

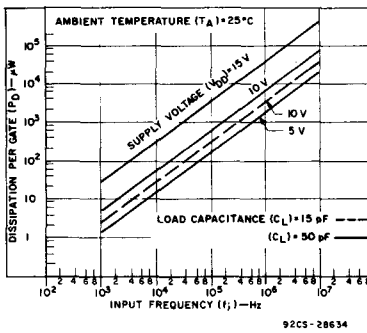

Fig. 14 - Typical dissipation vs. frequency characteristics.

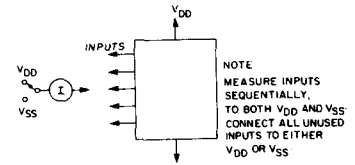

Fig. 15 - Input current test circuit.

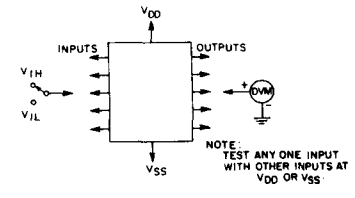

Fig. 16 - Input voltage test circuit.

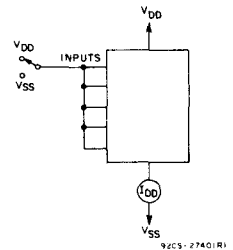
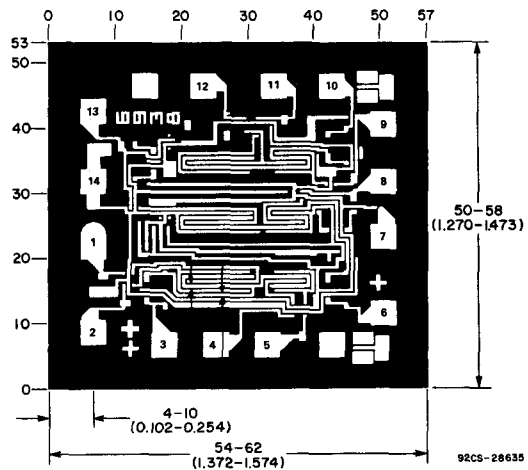

Fig. 17 - Quiescent device current test circuit.



## DIMENSIONS AND PAD LAYOUT FOR CD4007UBH

The photographs and dimensions of each CMOS chip represent a chip when it is part of the wafer. When the wafer is separated into individual chips, the angle of cleavage may vary with respect to the chip face for different chips. The actual dimensions of the isolated chip, therefore, may differ slightly from the nominal dimensions shown. The user should consider a tolerance of  $\pm 3$  mils to  $\pm 16$  mils applicable to the nominal dimensions shown.

# CD4008B Types

## CMOS 4-Bit Full Adder

With Parallel Carry Out

High-Voltage Types (20-Volt Rating)

The RCA-CD4008B types consist of four full adder stages with fast look ahead carry provision from stage to stage. Circuitry is included to provide a fast "parallel-carry-out" but to permit high-speed operation in arithmetic sections using several CD4008B's.

CD4008B inputs include the four sets of bits to be added, A<sub>1</sub> to A<sub>4</sub> and B<sub>1</sub> to B<sub>4</sub>, in addition to the "Carry In" bit from a previous section. CD4008B outputs include the four sum bits, S<sub>1</sub> to S<sub>4</sub>. In addition to the high speed "parallel-carry-out" which may be utilized at a succeeding CD4008B section.

The CD4008B types are supplied in 16-lead hermetic dual-in-line ceramic packages (D and F suffixes), 16-lead dual-in-line plastic packages (E suffix), 16-lead ceramic flat packages (K suffix), and in chip form (H suffix).

### Features:

- 4 sum outputs plus parallel look-ahead carry-output
- High-speed operation — sum in-to-sum out, 160 ns typ; carry in-to-carry out, 50 ns typ. at V<sub>DD</sub> = 10 V, C<sub>L</sub> = 50 pF
- Standardized, symmetrical output characteristics
- 100% tested for quiescent current at 20 V
- Maximum input current of 1 μA at 18 V over full package-temperature range; 100 nA at 18 V and 25°C
- Noise margin (over full package temperature range): 1 V at V<sub>DD</sub> = 5 V  
2 V at V<sub>DD</sub> = 10 V  
2.5 V at V<sub>DD</sub> = 15 V
- 5-V, 10-V, and 15-V parametric ratings
- Meets all requirements of JEDEC Tentative Standard No. 13A, "Standard Specifications for Description of 'B' Series CMOS Devices"

### Applications:

- Binary addition/arithmetic units

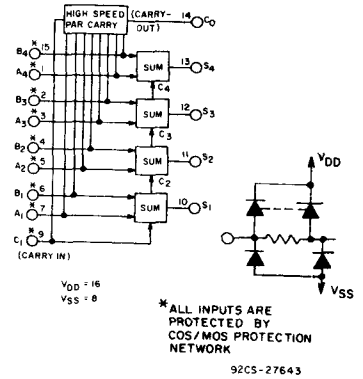
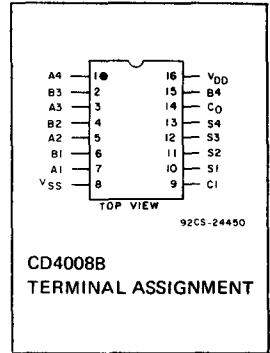

Fig. 1 — CD4008B logic diagram.

### STATIC ELECTRICAL CHARACTERISTICS

CHARACTER- ISTIC	CONDITIONS			LIMITS AT INDICATED TEMPERATURES (°C)							UNITS
	V <sub>O</sub> (V)	V <sub>IN</sub> (V)	V <sub>DD</sub> (V)	+25							
				-55	-40	+85	+125	Min.	Typ.	Max.	
Quiescent Device Current, I <sub>DD</sub> Max.	-	0,5	5	5	5	150	150	-	0.04	5	μA
	-	0,10	10	10	10	300	300	-	0.04	10	
	-	0,15	15	20	20	600	600	-	0.04	20	
	-	0,20	20	100	100	3000	3000	-	0.08	100	
Output Low (Sink) Current I <sub>OL</sub> Min.	0.4	0,5	5	0.64	0.61	0.42	0.36	0.51	1	-	mA
	0.5	0,10	10	1.6	1.5	1.1	0.9	1.3	2.6	-	
	1.5	0,15	15	4.2	4	2.8	2.4	3.4	6.8	-	
	9.5	0,15	15	-4.2	-4	-2.8	-2.4	-3.4	-6.8	-	
Output High (Source) Current, I <sub>OH</sub> Min.	4.6	0,5	5	-0.64	-0.61	-0.42	-0.36	-0.51	-1	-	mA
	2.5	0,5	5	-2	-1.8	-1.3	-1.15	-1.6	-3.2	-	
	9.5	0,10	10	-1.6	-1.5	-1.1	-0.9	-1.3	-2.6	-	
	13.5	0,15	15	-4.2	-4	-2.8	-2.4	-3.4	-6.8	-	
Output Voltage: Low-Level, V <sub>OL</sub> Max.	-	0,5	5	0.05			-	0	0.05	V	
	-	0,10	10	0.05			-	0	0.05		
	-	0,15	15	0.05			-	0	0.05		
Output Voltage: High-Level, V <sub>OH</sub> Min.	-	0,5	5	4.95			4.95	5	-	V	
	-	0,10	10	9.95			9.95	10	-		
	-	0,15	15	14.95			14.95	15	-		
Input Low Voltage, V <sub>IL</sub> Max.	0.5, 4.5	-	5	1.5			-	-	1.5	V	
	1, 9	-	10	3			-	-	3		
	1.5, 13.5	-	15	4			-	-	4		
Input High Voltage, V <sub>IH</sub> Min.	0.5, 4.5	-	5	3.5			3.5	-	-	V	
	1, 9	-	10	7			7	-	-		
	1.5, 13.5	-	15	11			11	-	-		
Input Current I <sub>IN</sub> Max.	-	0,18	18	±0.1	±0.1	±1	±1	-	±10 <sup>-5</sup>	±0.1	μA

**TRUTH TABLE**

A <sub>i</sub>	B <sub>i</sub>	C <sub>i</sub>	C <sub>0</sub>	SUM
0	0	0	0	0
1	0	0	0	1
0	1	0	0	1
1	1	0	1	0
0	0	1	0	1
1	0	1	1	0
0	1	1	1	0
1	1	1	1	1

# CD4008B Types

**RECOMMENDED OPERATING CONDITIONS** at  $T_A = 25^\circ\text{C}$ , Except as Noted.  
For maximum reliability, nominal operating conditions should be selected so that operation is always within the following ranges:

CHARACTERISTIC	LIMITS		UNITS
	MIN.	MAX.	
Supply-Voltage Range (For $T_A = \text{Full Package Temperature Range}$ )	3	18	V

**MAXIMUM RATINGS, Absolute-Maximum Values:**

DC SUPPLY-VOLTAGE RANGE, ( $V_{DD}$ ) (Voltages referenced to $V_{SS}$ Terminal)	-0.5 to +20 V
INPUT VOLTAGE RANGE, ALL INPUTS	-0.5 to $V_{DD} + 0.5$ V
DC INPUT CURRENT, ANY ONE INPUT	$\pm 10$ mA
POWER DISSIPATION PER PACKAGE ( $P_D$ ):	
For $T_A = -40$ to $+60^\circ\text{C}$ (PACKAGE TYPE E)	500 mW
For $T_A = +60$ to $+85^\circ\text{C}$ (PACKAGE TYPE E)	Derate Linearly at $12 \text{ mW}/^\circ\text{C}$ to 200 mW
For $T_A = -55$ to $+100^\circ\text{C}$ (PACKAGE TYPES D, F, K)	500 mW
For $T_A = +100$ to $+125^\circ\text{C}$ (PACKAGE TYPES D, F, K)	Derate Linearly at $12 \text{ mW}/^\circ\text{C}$ to 200 mW
DEVICE DISSIPATION PER OUTPUT TRANSISTOR	
For $T_A = \text{FULL PACKAGE-TEMPERATURE RANGE}$ (All Package Types)	100 mW
OPERATING-TEMPERATURE RANGE ( $T_A$ ):	
PACKAGE TYPES D, F, K, H	$-55$ to $+125^\circ\text{C}$
PACKAGE TYPE E	$-40$ to $+85^\circ\text{C}$
STORAGE TEMPERATURE RANGE ( $T_{stg}$ )	$-65$ to $+150^\circ\text{C}$
LEAD TEMPERATURE (DURING SOLDERING):	
At distance $1/16 \pm 1/32$ inch ( $1.59 \pm 0.79$ mm) from case for 10 s max.	$+265^\circ\text{C}$

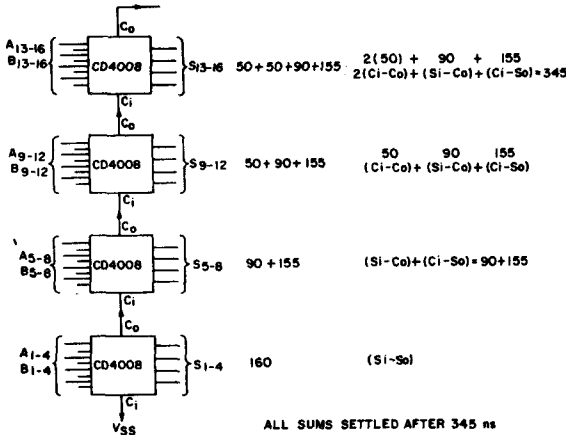

Fig.2 - Typical propagation delay for a 16-bit adder (10 V operation).

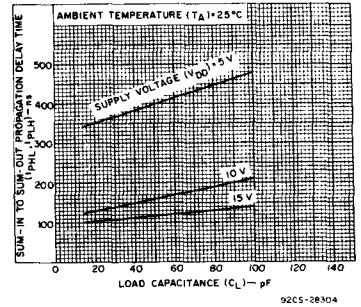

Fig.3 - Typical sum-in to sum-out propagation delay time vs. load capacitance.

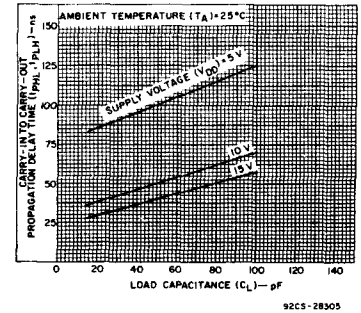

Fig.4 - Typical carry-in to carry-out propagation delay time vs. load capacitance.

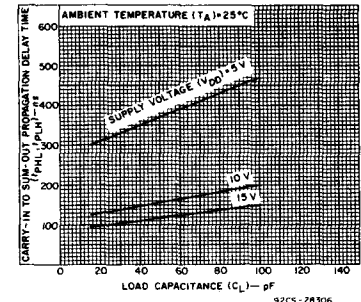

Fig.5 - Typical carry-in to sum-out propagation delay time vs. load capacitance.

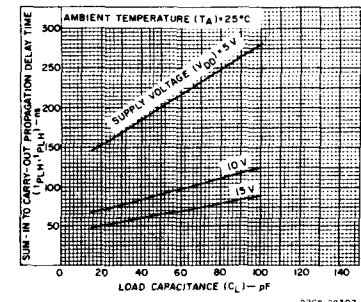

Fig.6 - Typical sum-in to carry-out propagation delay time vs. load capacitance.

# CD4008B Types

## DYNAMIC ELECTRICAL CHARACTERISTICS

At  $T_A = 25^\circ\text{C}$ ; Input  $t_r, t_f = 20\text{ ns}$ ,  $C_L = 50\text{ pF}$ ,  $R_L = 200\text{ k}\Omega$

CHARACTERISTIC	V <sub>DD</sub> (V)	LIMITS ALL TYPES		UNITS
		TYP.	MAX.	
Propagation Delay Time: t <sub>PHL</sub> , t <sub>PLH</sub> Sum In to Sum Out	5	400	800	ns
	10	160	320	
	15	115	230	
Carry In to Sum Out	5	370	740	ns
	10	155	310	
	15	115	230	
Sum In to Carry Out	5	200	400	ns
	10	90	180	
	15	65	130	
Carry In to Carry Out	5	100	200	ns
	10	50	100	
	15	40	80	
Transition Time: t <sub>THL</sub> , t <sub>TLH</sub>	5	100	200	ns
	10	50	100	
	15	40	80	
Input Capacitance, C <sub>IN</sub>	—	5	7.5	pF

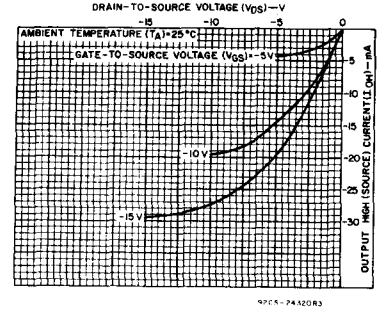

Fig.7 — Typical output high (source) current characteristics.

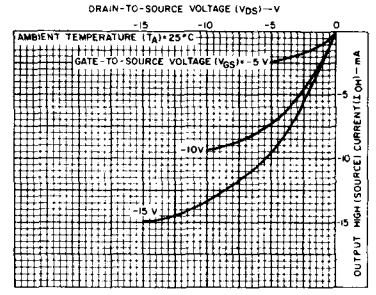

Fig.8 — Minimum output high (source) current characteristics.

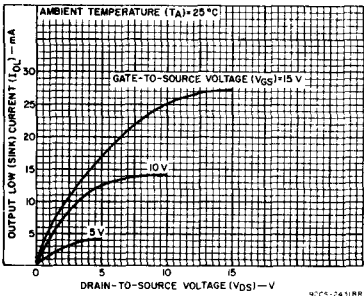

Fig.9 — Typical output low (sink) current characteristics.

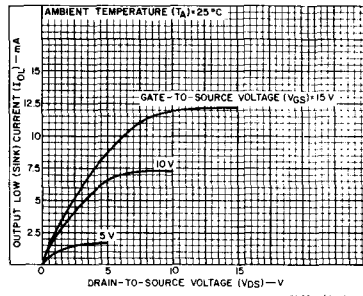

Fig.10 — Minimum output low (sink) current characteristics.

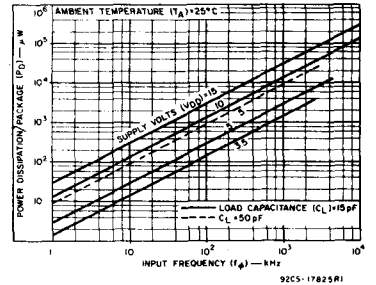

Fig.11 — Typical dissipation characteristics.

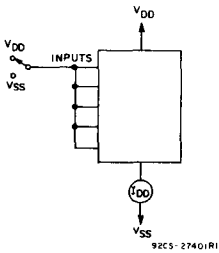

Fig.12 — Quiescent-device-current test circuit.

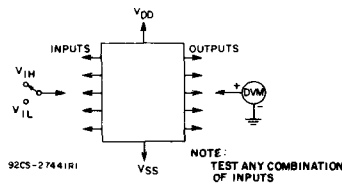

Fig.13 — Input-voltage test circuit.

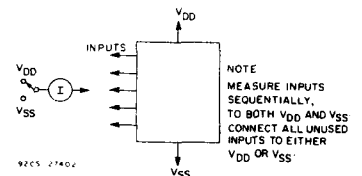
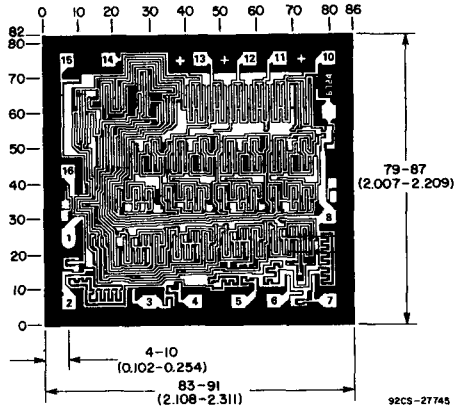

Fig.14 — Input current test circuit.

## CD4008B Types



*Dimensions in parentheses are in millimeters and are derived from the basic inch dimensions as indicated. Grid graduations are in mils ( $10^{-3}$  inch).*

*The photographs and dimensions of each CMOS chip represent a chip when it is part of the wafer. When the wafer is separated into individual chips, the angle of cleavage may vary with respect to the chip face for different chips. The actual dimensions of the isolated chip, therefore, may differ slightly from the nominal dimensions shown. The user should consider a tolerance of  $-3$  mils to  $+16$  mils applicable to the nominal dimensions shown.*

### Dimensions and Pad Layout for CD4008BH

# CD4009UB, CD4010B Types

## CMOS Hex Buffers/Converters

High-Voltage Types (20-Volt Rating)  
 Inverting Type: CD4009UB  
 Non-Inverting Type: CD4010B

The RCA-CD4009UB and CD4010B Hex Buffer/Converters may be used as CMOS to TTL or DTL logic-level converters or CMOS high-sink-current drivers.

The CD4049UB and CD4050B are preferred hex buffer replacements for the CD4009UB and CD4010B, respectively, in all applications except multiplexers. For applications not requiring high sink current or voltage conversion, the CD4069UB Hex Inverter is recommended.

The CD4009UB and CD4010B types are supplied in 16-lead hermetic dual-in-line ceramic packages (D and F suffixes), 16-lead dual-in-line plastic packages (E suffix), 16-lead ceramic flat packages (K suffix), and in chip form (H suffix).

### Features:

- 100% tested for quiescent current at 20 V
- Maximum input current of 1  $\mu$ A at 18 V over full package-temperature range; 100 nA at 18 V and 25°C
- 5-V, 10-V, and 15-V parametric ratings

### Applications:

- CMOS to DTL/TTL hex converter
- CMOS current "sink" or "source" driver
- CMOS high-to-low logic-level converter
- Multiplexer — 1 to 6 or 6 to 1

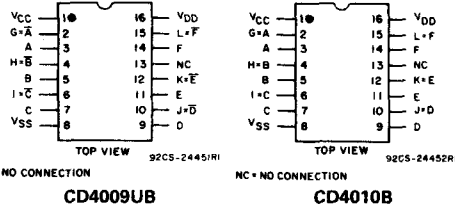

### TERMINAL ASSIGNMENTS

### MAXIMUM RATINGS, Absolute-Maximum Values:

DC SUPPLY-VOLTAGE RANGE, (V <sub>DD</sub> , V <sub>CC</sub> ) (Voltages referenced to V <sub>SS</sub> Terminal)	-0.5 to +20 V
INPUT VOLTAGE RANGE, ALL INPUTS	-0.5 to V <sub>DD</sub> + 0.5 V
DC INPUT CURRENT, ANY ONE INPUT	±10 mA
POWER DISSIPATION PER PACKAGE (P <sub>D</sub> ):	
For T <sub>A</sub> = -40 to +60°C (PACKAGE TYPE E)	500 mW
For T <sub>A</sub> = +60 to +85°C (PACKAGE TYPE E)	Derate Linearly at 12 mW/°C to 200 mW
For T <sub>A</sub> = -55 to +100°C (PACKAGE TYPES D, F, K)	500 mW
For T <sub>A</sub> = +100 to +125°C (PACKAGE TYPES D, F, K)	Derate Linearly at 12 mW/°C to 200 mW
DEVICE DISSIPATION PER OUTPUT TRANSISTOR FOR T <sub>A</sub> = FULL PACKAGE-TEMPERATURE RANGE (All Package Types)	100 mW
OPERATING-TEMPERATURE RANGE (T <sub>A</sub> ):	
PACKAGE TYPES D, F, K, H	-55 to +125°C
PACKAGE TYPE E	-40 to +85°C
STORAGE TEMPERATURE RANGE (T <sub>stg</sub> )	-65 to +150°C
LEAD TEMPERATURE (DURING SOLDERING):	
At distance 1/16 ± 1/32 inch (1.59 ± 0.79 mm) from case for 10 s max.	+265°C

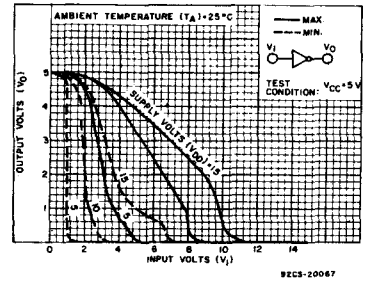
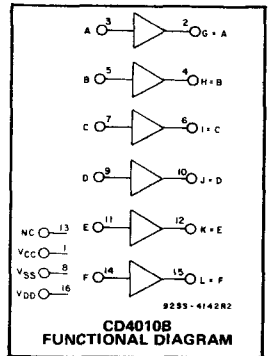
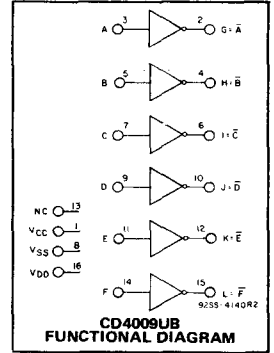

Fig. 3 — Minimum and maximum voltage transfer characteristics—CD4009UB.

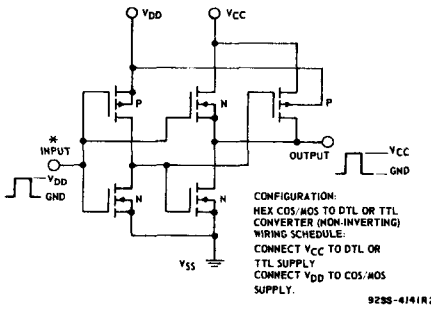
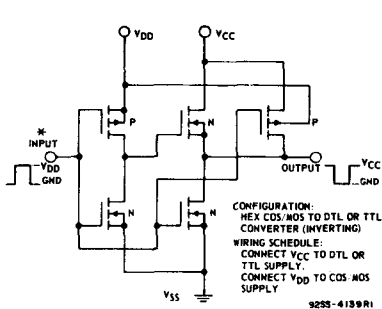
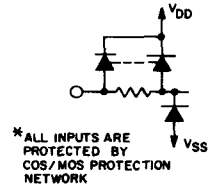

Fig. 1 — Schematic diagram of CD4009UB—1 of 6 identical stages.

Fig. 2 — Schematic diagram of CD4010B—1 of 6 identical stages.



\* ALL INPUTS ARE PROTECTED BY COS/MOS PROTECTION NETWORK



# CD4009UB, CD4010B Types

## RECOMMENDED OPERATING CONDITIONS

For maximum reliability, nominal operating conditions should be selected so that operation is always within the following ranges:

CHARACTERISTIC	LIMITS		UNITS
	MIN.	MAX.	
Supply-Voltage Range (For $T_A$ = Full Package Temperature Range), $V_{DD}$	3	18	V
$V_{CC}^*$	3	$V_{DD}$	V
Input Voltage Range ( $V_I$ )	$V_{CC}^*$	$V_{DD}$	V

\*The CD4009UB and CD4010B have high-to-low level voltage conversion capability but not low-to-high level, therefore it is recommended that  $V_{DD} > V_I > V_{CC}$ .

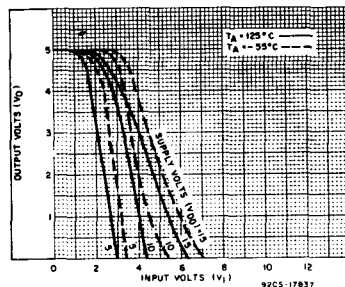

Fig. 4 - Typical voltage transfer characteristics as function of temp.—CD4009UB.

## STATIC ELECTRICAL CHARACTERISTICS

CHARACTERISTIC	CONDITIONS		Limits At Indicated Temperatures (°C)								UNITS
			Values at -55,+25,+125 Apply to D,F,K,H Pkgs.								
			Values at -40,+25,+85 Apply to E Package								
$V_O$ (V)	$V_{IN}$ (V)	$V_{DD}$ (V)	-55	-40	+85	+125	+25				
							Min.	Typ.	Max.		
Quiescent Device Current, $I_{DD}$ Max.	-	0.5	5	1	1	30	30	-	0.02	1	$\mu$ A
	-	0.10	10	2	2	60	60	-	0.02	2	
	-	0.15	15	4	4	120	120	-	0.02	4	
Output Low (Sink) Current $I_{OL}$ Min.	0.4	0.5	4.5	3.2	3.1	2.1	1.8	2.6	3.4	-	mA
	0.4	0.5	5	3.75	3.6	2.4	2.1	3	4	-	
	0.5	0.10	10	10	9.6	6.4	5.6	8	10	-	
Output High (Source) Current $I_{OH}$ Min.	1.5	0.15	15	30	40	19	16	24	36	-	mA
	4.6	0.5	5	-0.25	-0.23	-0.18	-0.15	-0.2	-0.4	-	
	2.5	0.5	5	-1	-0.9	-0.65	-0.58	-0.8	-1.6	-	
Output Voltage: Low-Level, $V_{OL}$ Max.	9.5	0.10	10	-0.55	-0.5	-0.38	-0.33	-0.45	-0.9	-	V
	13.5	0.15	15	-1.65	-1.6	-1.25	-1.1	-1.5	-3	-	
	-	0.5	5			0.05			0	0.05	
Output Voltage: High-Level, $V_{OH}$ Min.	-	0.10	10			0.05			0	0.05	V
	-	0.15	15			0.05			0	0.05	
	-	0.5	5			4.95			4.95	5	
Input Low Voltage: $V_{IL}$ Max. CD4009UB	-	0.10	10			9.95			9.95	10	V
	-	0.15	15			14.95			14.95	15	
	4.5	-	5			1			-	1	
Input Low Voltage: $V_{IL}$ Max. CD4010B	9	-	10			2			-	2	V
	13.5	-	15			2.5			-	2.5	
	0.5	-	5			1.5			-	1.5	
Input High Voltage: $V_{IH}$ Min. CD4009UB	1	-	10			3			-	3	V
	1.5	-	15			4			-	4	
	0.5	-	5			4			4	-	
Input High Voltage: $V_{IH}$ Min. CD4010B	1	-	10			8			8	-	V
	1.5	-	15			12.5			12.5	-	
	4.5	-	5			3.5			3.5	-	
Input Current, $I_{IN}$ Max.	9	-	10			7			7	-	$\mu$ A
	13.5	-	15			11			11	-	
	-	0.18	18	$\pm 0.1$	$\pm 0.1$	$\pm 1$	$\pm 1$	-	$\pm 10^{-5}$	$\pm 0.1$	

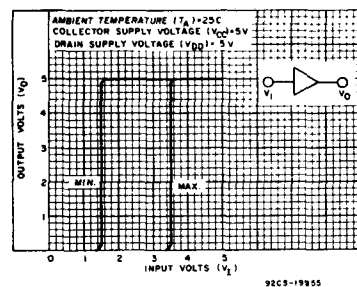

Fig. 5 - Minimum and maximum voltage transfer characteristics ( $V_{DD}=5$ )—CD4010B.

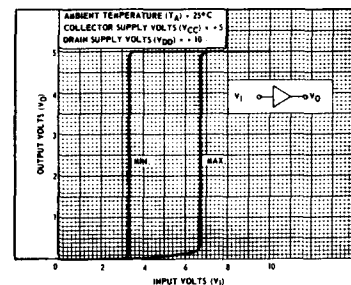

Fig. 6 - Minimum and maximum voltage transfer characteristics ( $V_{DD}=10$ )—CD4010B.

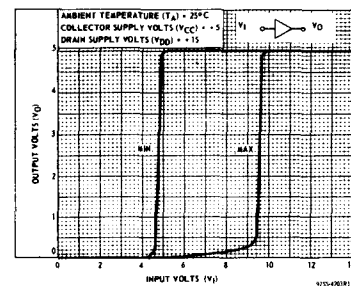

Fig. 7 - Minimum and maximum voltage transfer characteristics ( $V_{DD}=15$ )—CD4010B.

# CD4009UB, CD4010B Types

**DYNAMIC ELECTRICAL CHARACTERISTICS at  $T_A=25^\circ\text{C}$ ; Input  $t_r, t_f=20\text{ ns}$ ,  $C_L=50\text{ pF}$ ,  $R_L=200\text{ K}\Omega$**

CHARACTERISTIC	CONDITIONS			LIMITS ALL PKGS		UNIT	
	V <sub>DD</sub> (V)	V <sub>I</sub> (V)	V <sub>CC</sub> (V)	TYP.	MAX.		
Propagation Delay Time: Low-to-High, t <sub>PLH</sub>	CD4009UB	5	5	5	70	140	ns
		10	10	10	40	80	
		10	10	5	35	70	
		15	15	15	30	60	
		15	15	5	30	60	
	CD4010B	5	5	5	100	200	ns
		10	10	10	50	100	
		10	10	5	50	100	
		15	15	15	35	70	
		15	15	5	35	70	
High-to-Low, t <sub>PHL</sub>	CD4009UB	5	5	5	30	60	ns
		10	10	10	20	40	
		10	10	5	15	30	
		15	15	15	15	30	
		15	15	5	10	20	
	CD4010B	5	5	5	65	130	ns
		10	10	10	35	70	
		10	10	5	30	70	
		15	15	15	25	50	
		15	15	5	20	40	
Transition Time: Low-to-High, t <sub>TLH</sub>	CD4009UB	5	5	5	150	350	ns
		10	10	10	75	150	
		15	15	15	55	110	
	CD4010B	5	5	5	35	70	ns
		10	10	10	20	40	
		15	15	15	15	30	
Input Capacitance, C <sub>IN</sub>	CD4009UB	—	—	—	15	22.5	pF
	CD4010B	—	—	—	5	7.5	

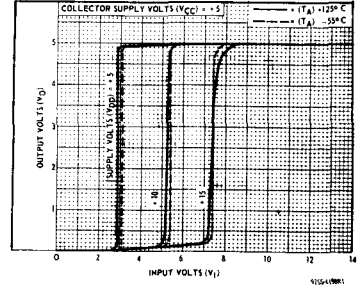

Fig. 8 – Typical voltage transfer characteristics as a function of temperature—CD4010B.

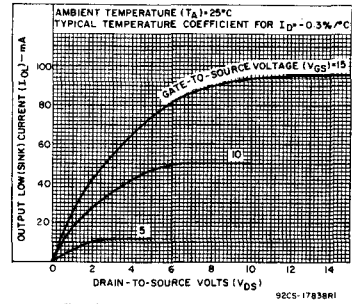

Fig. 9 – Typical output low (sink) current characteristics.

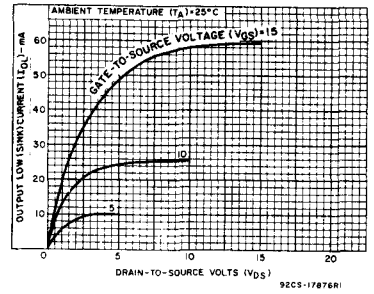

Fig. 10 – Minimum output low (sink) current characteristics.

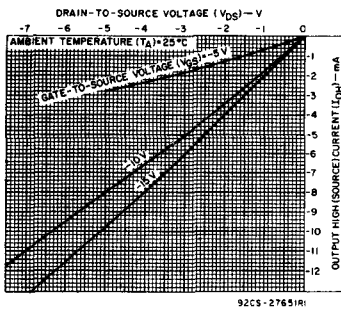

Fig. 11 – Typical output high (source) current characteristics.

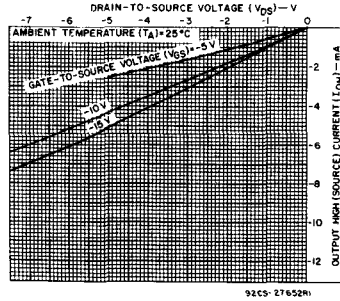

Fig. 12 – Minimum output high (source) current characteristics.

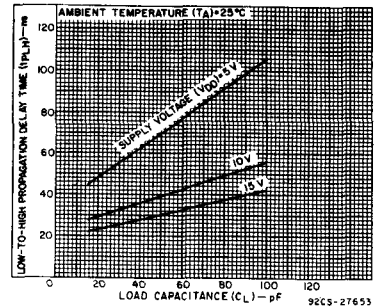

Fig. 13 – Typical low-to-high propagation delay time vs. load capacitance (CD4009UB).

# CD4009UB, CD4010B Types

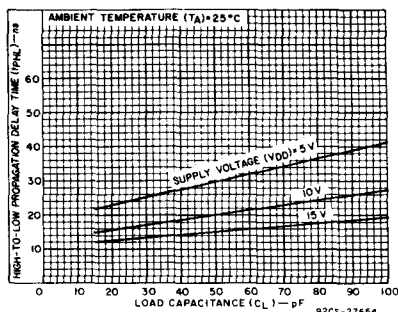

Fig. 14 - Typical high-to-low propagation delay time vs. load capacitance (CD4009UB).

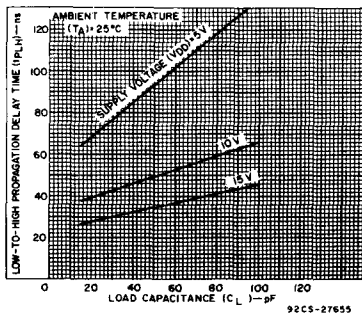

Fig. 15 - Typical low-to-high propagation delay time vs. load capacitance (CD4010B).

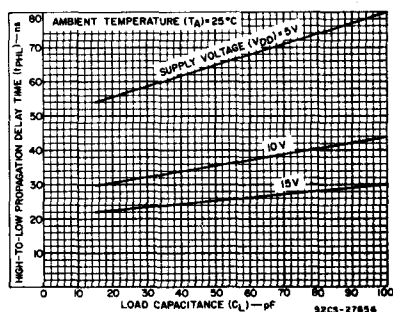

Fig. 16 - Typical high-to-low propagation delay time vs. load capacitance (CD4010B).

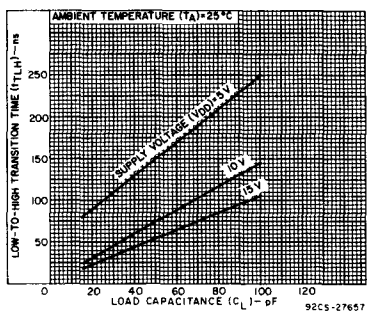

Fig. 17 - Typical low-to-high transition time vs. load capacitance.

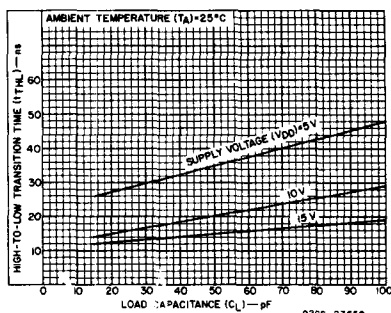

Fig. 18 - Typical high-to-low transition time vs. load capacitance.

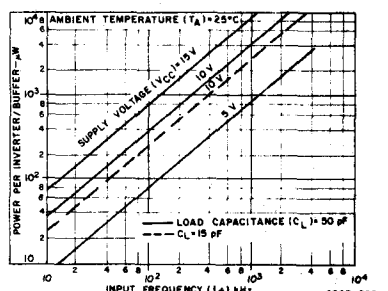

Fig. 19 - Typical dissipation characteristics.

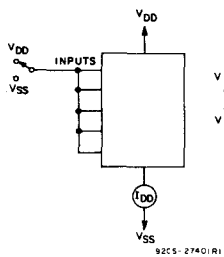

Fig. 20 - Quiescent device current test circuit.

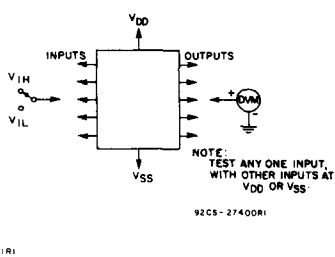

Fig. 21 - Noise immunity test circuit.

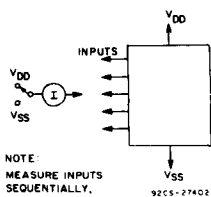
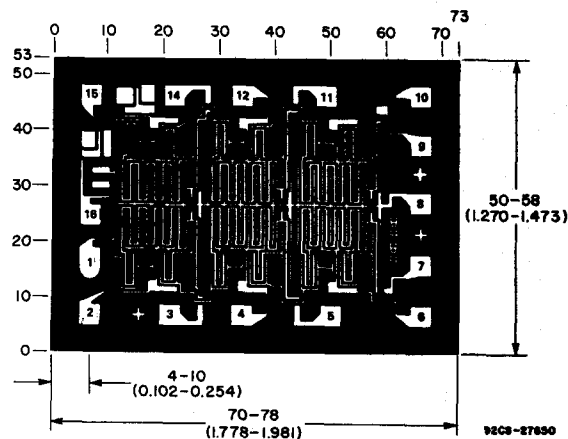

Fig. 22 - Input current test circuit.



Dimensions in parentheses are in millimeters and are derived from the basic inch dimensions as indicated. Grid Graduations Are In Mil (10<sup>-3</sup> Inch)

The photographs and dimensions of each CMOS chip represent a chip when it is part of the wafer. When the wafer is separated into individual chips, the angle of cleavage may vary with respect to the chip face for different chips. The actual dimensions of the isolated chip, therefore, may differ slightly from the nominal dimensions shown. The user should consider a tolerance of -3 mils to +16 mils applicable to the nominal dimensions shown.

Photograph of chip for CD4009UB. Dimensions and pad layout for CD4010B are identical.

# CD4011B, CD4012B, CD4023B Types

## CMOS NAND GATES

High-Voltage Types (20-Volt Rating)

Quad 2 Input – CD4011B  
Dual 4 Input – CD4012B  
Triple 3 Input – CD4023B

RCA-CD4011B, CD4012B, and CD4023B NAND gates provide the system designer with direct implementation of the NAND function and supplement the existing family of CMOS gates. All inputs and outputs are buffered.

The CD4011B, CD4012B, and CD4023B types are supplied in 14-lead hermetic dual-in-line ceramic packages (D and F suffixes), 14-lead dual-in-line plastic packages (E suffix), 14-lead ceramic flat packages (K suffix), and in chip form (H suffix).

### Features:

- Propagation delay time = 60 ns (typ.) at  $C_L = 50$  pF,  $V_{DD} = 10$  V
- Buffered inputs and outputs
- Standardized symmetrical output characteristics
- Maximum input current of 1  $\mu$ A at 18 V over full package temperature range; 100 nA at 18 V and 25°C
- 100% tested for quiescent current at 20 V
- 5-V, 10-V, and 15-V parametric ratings
- Noise margin (over full package temperature range):
  - 1 V at  $V_{DD} = 5$  V
  - 2 V at  $V_{DD} = 10$  V
  - 2.5 V at  $V_{DD} = 15$  V
- Meets all requirements of JEDEC Tentative Standard No.13A, "Standard Specifications for Description of "B" Series CMOS Devices"

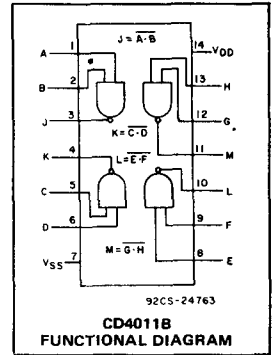

### MAXIMUM RATINGS, Absolute-Maximum Values:

DC SUPPLY-VOLTAGE RANGE, ( $V_{DD}$ ) (Voltages referenced to $V_{SS}$ Terminal)	-0.5 to +20 V
INPUT VOLTAGE RANGE, ALL INPUTS	-0.5 to $V_{DD} + 0.5$ V
DC INPUT CURRENT, ANY ONE INPUT	$\pm 10$ mA
POWER DISSIPATION PER PACKAGE ( $P_D$ ):	
For $T_A = -40$ to $+60^\circ\text{C}$ (PACKAGE TYPE E)	500 mW
For $T_A = +60$ to $+85^\circ\text{C}$ (PACKAGE TYPE E)	Derate Linearly at 12 mW/ $^\circ\text{C}$ to 200 mW
For $T_A = -55$ to $+100^\circ\text{C}$ (PACKAGE TYPES D, F, K)	500 mW
For $T_A = +100$ to $+125^\circ\text{C}$ (PACKAGE TYPES D, F, K)	Derate Linearly at 12 mW/ $^\circ\text{C}$ to 200 mW
DEVICE DISSIPATION PER OUTPUT TRANSISTOR	
FOR $T_A =$ FULL PACKAGE-TEMPERATURE RANGE (All Package Types)	100 mW
OPERATING-TEMPERATURE RANGE ( $T_A$ ):	
PACKAGE TYPES D, F, K, H	$-55$ to $+125^\circ\text{C}$
PACKAGE TYPE E	$-40$ to $+85^\circ\text{C}$
STORAGE TEMPERATURE RANGE ( $T_{stg}$ )	$-65$ to $+150^\circ\text{C}$
LEAD TEMPERATURE (DURING SOLDERING):	
At distance 1/16 $\pm$ 1/32 inch (1.59 $\pm$ 0.79 mm) from case for 10 s max.	$+265^\circ\text{C}$

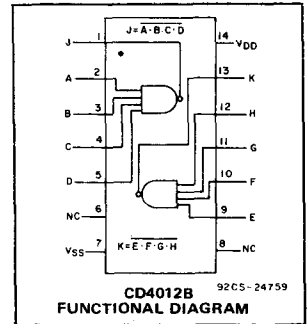

### RECOMMENDED OPERATING CONDITIONS

For maximum reliability, nominal operating conditions should be selected so that operation is always within the following ranges:

CHARACTERISTIC	LIMITS		UNITS
	MIN.	MAX.	
Supply-Voltage Range (For $T_A =$ Full Package Temperature Range)	3	18	V

### TERMINAL ASSIGNMENTS

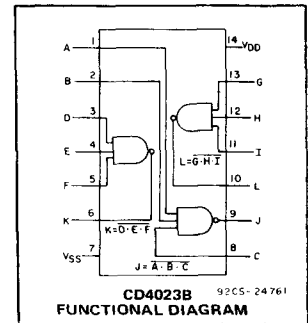
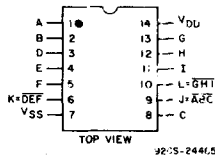
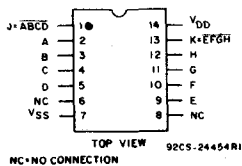
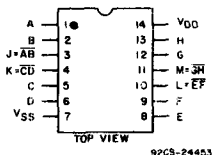

# CD4011B, CD4012B, CD4023B Types

## STATIC ELECTRICAL CHARACTERISTICS

CHARACTERISTIC	CONDITIONS			LIMITS AT INDICATED TEMPERATURES (°C)							UNITS
	V <sub>O</sub> (V)	V <sub>IN</sub> (V)	V <sub>DD</sub> (V)	Values at -55, +25, +125 Apply to D, F, K, H Packages Values at -40, +25, +85 Apply to E Package							
				-55	-40	+85	+125	+25		Max.	
				Min.	Typ.						
Quiescent Device Current, I <sub>DD</sub> Max.	-	0,5	5	0.25	0.25	7.5	7.5	-	0.01	0.25	μA
	-	0,10	10	0.5	0.5	15	15	-	0.01	0.5	
	-	0,15	15	1	1	30	30	-	0.01	1	
Output Low (Sink) Current I <sub>OL</sub> Min.	0.4	0,5	5	0.64	0.61	0.42	0.36	0.51	1	-	mA
	0.5	0,10	10	1.6	1.5	1.1	0.9	1.3	2.6	-	
	1.5	0,15	15	4.2	4	2.8	2.4	3.4	6.8	-	
Output High (Source) Current, I <sub>OH</sub> Min.	4.6	0,5	5	-0.64	-0.61	-0.42	-0.36	-0.51	-1	-	mA
	2.5	0,5	5	-2	-1.8	-1.3	-1.15	-1.6	-3.2	-	
	9.5	0,10	10	-1.6	-1.5	-1.1	-0.9	-1.3	-2.6	-	
	13.5	0,15	15	-4.2	-4	-2.8	-2.4	-3.4	-6.8	-	
Output Voltage: Low-Level, V <sub>OL</sub> Max.	-	0,5	5	0.05				-	0	0.05	V
	-	0,10	10	0.05				-	0	0.05	
	-	0,15	15	0.05				-	0	0.05	
Output Voltage: High-Level, V <sub>OH</sub> Min.	-	0,5	5	4.95				4.95	5	-	V
	-	0,10	10	9.95				9.95	10	-	
	-	0,15	15	14.95				14.95	15	-	
Input Low Voltage, V <sub>IL</sub> Max.	4.5	-	5	1.5				-	-	1.5	V
	9	-	10	3				-	-	3	
	13.5	-	15	4				-	-	4	
Input High Voltage, V <sub>IH</sub> Min.	0.5,4.5	-	5	3.5				3.5	-	-	V
	1.9	-	10	7				7	-	-	
	1.5,13.5	-	15	11				11	-	-	
Input Current I <sub>IN</sub> Max.		0,18	18	±0.1	±0.1	±1	±1	-	±10 <sup>-5</sup>	±0.1	μA

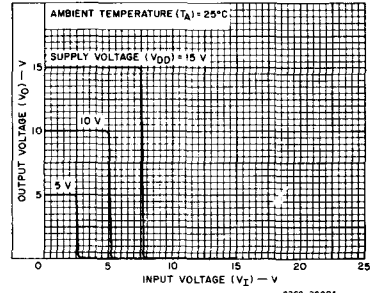

Fig. 1 - Typical voltage transfer characteristics.

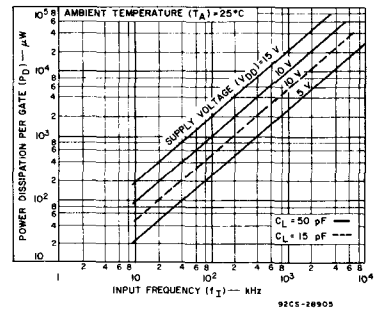

Fig. 2 - Typical power dissipation characteristics.

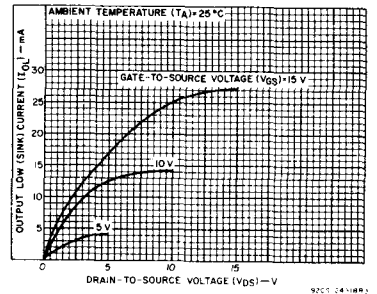

Fig. 3 - Typical output low (sink) current characteristics.

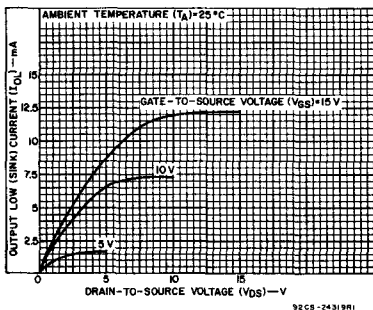

Fig. 4 - Minimum output low (sink) current characteristics.

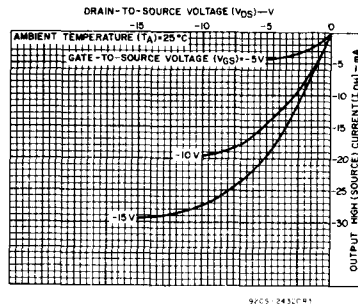

Fig. 5 - Typical output high (source) current characteristics.

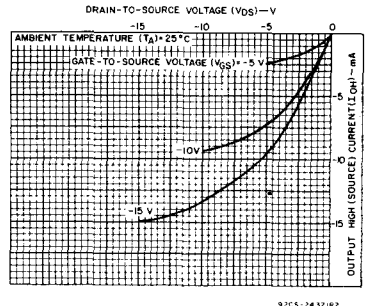

Fig. 6 - Minimum output high (source) current characteristics.

# CD4011B, CD4012B, CD4023B Types

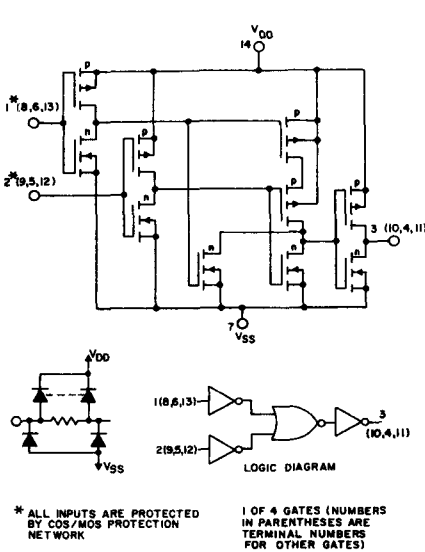

Fig. 7 - Schematic and logic diagrams for CD4011B.

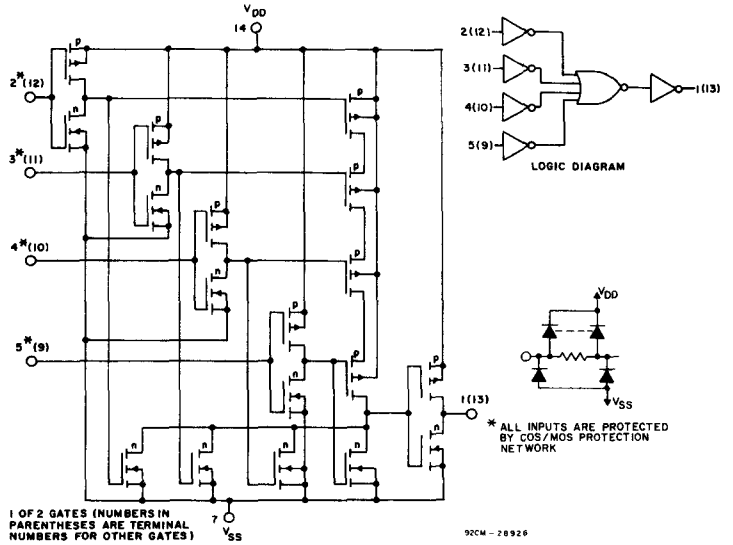

Fig. 8 - Schematic and logic diagrams for CD4012B.

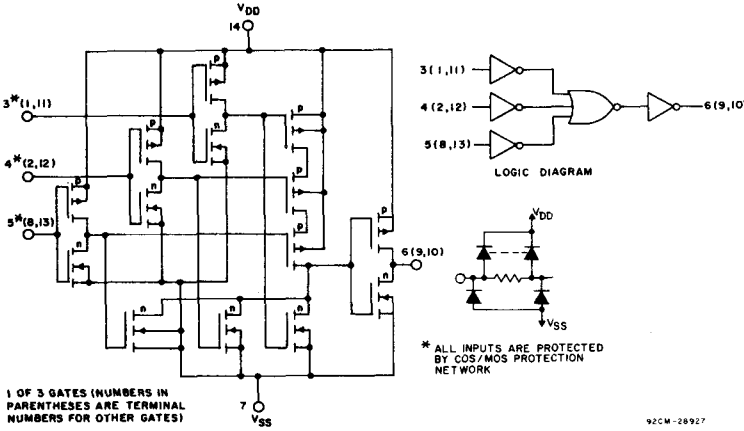

Fig. 9 - Schematic and logic diagrams for CD4023B.

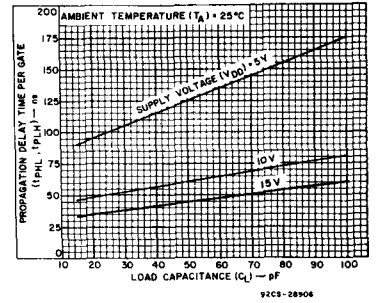

Fig. 10 - Typical propagation delay time per gate as a function of load capacitance.

## DYNAMIC ELECTRICAL CHARACTERISTICS

At  $T_A = 25^\circ\text{C}$ ; Input  $t_r, t_f = 20\text{ ns}$ ,  $C_L = 50\text{ pF}$ ,  $R_L = 200\text{ k}\Omega$

CHARACTERISTIC	TEST CONDITIONS	ALL TYPES LIMITS		UNITS	
		$V_{DD}$ VOLTS	TYP.		MAX.
Propagation Delay Time, $t_{PHL}, t_{PLH}$	Any Input	5	125	250	ns
		10	60	120	
		15	45	90	
Transition Time, $t_{THL}, t_{TLH}$	Any Input	5	100	200	ns
		10	50	100	
		15	40	80	
Input Capacitance, $C_{iN}$	Any Input		5	7.5	pF

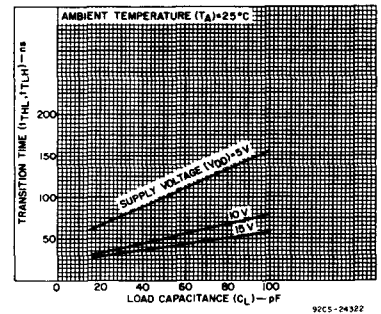

Fig. 11 - Typical transition time as a function of load capacitance.

# CD4011B, CD4012B, CD4023B Types

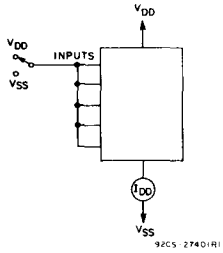

Fig. 12 - Quiescent-device-current test circuit.

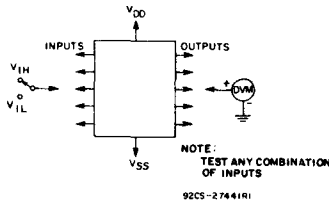

Fig. 13 - Input-voltage test circuit.

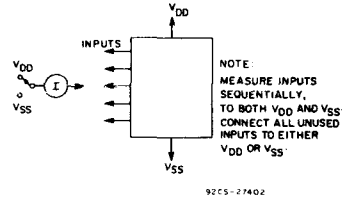
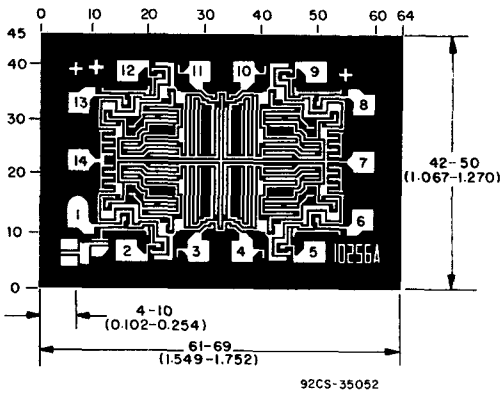
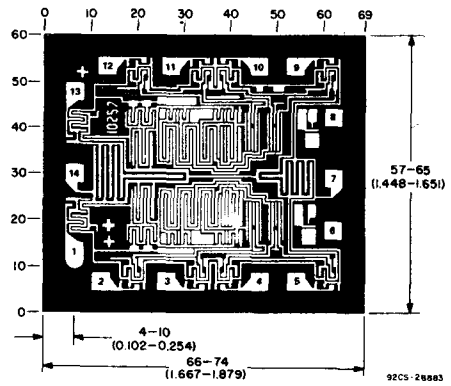

Fig. 14 - Input-current test circuit.

## CHIP PHOTOGRAPHS Dimensions and Pad Layouts



CD4011BH



CD4012BH

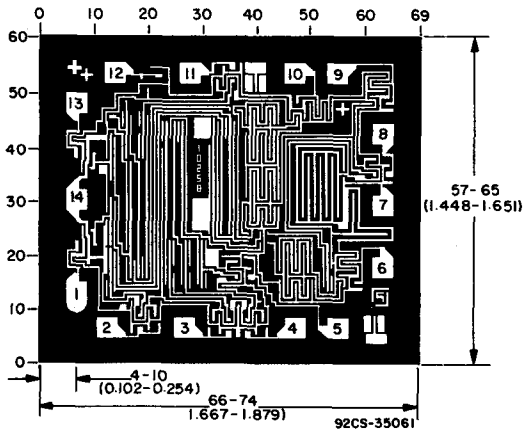

CD4023BH

Dimensions in parentheses are in millimeters and are derived from the basic inch dimensions as indicated. Grid graduations are in mils ( $10^{-3}$  inch).

The photographs and dimensions of each CMOS chip represent a chip when it is part of the wafer. When the wafer is separated into individual chips, the angle of cleavage may vary with respect to the chip face for different chips. The actual dimensions of the isolated chip, therefore, may differ slightly from the nominal dimensions shown. The user should consider a tolerance of  $-3$  mils to  $+16$  mils applicable to the nominal dimensions shown.

# CD4011UB, CD4012UB, CD4023UB Types

## CMOS NAND Gates

High-Voltage Types (20-Volt Rating)

- Quad 2 Input – CD4011UB
- Dual 4 Input – CD4012UB
- Triple 3 Input – CD4023UB

The RCA-CD4011UB, CD4012UB, and CD4023UB NAND gates provide the system designer with direct implementation of the NAND function and supplement the existing family of CMOS gates.

The CD4011UB, CD4012UB, and CD4023UB types are supplied in 14-lead hermetic dual-in-line ceramic packages (D and F suffixes), 14-lead dual-in-line plastic packages (E suffix), 14-lead ceramic flat packages (K suffix), and in chip form (H suffix).

### Features:

- Propagation delay time = 30 ns (typ.) at  $C_L = 50$  pF,  $V_{DD} = 10$  V
- Standardized symmetrical output characteristics
- 100% tested for quiescent current at 20 V
- Maximum input current of 1  $\mu$ A at 18 V over full package temperature range; 100 nA at 18 V and 25°C
- 5-V, 10-V, and 15-V parametric ratings
- Meets all requirements of JEDEC Tentative Standard No. 13A, "Standard Specifications for Description of 'B' Series CMOS Devices"

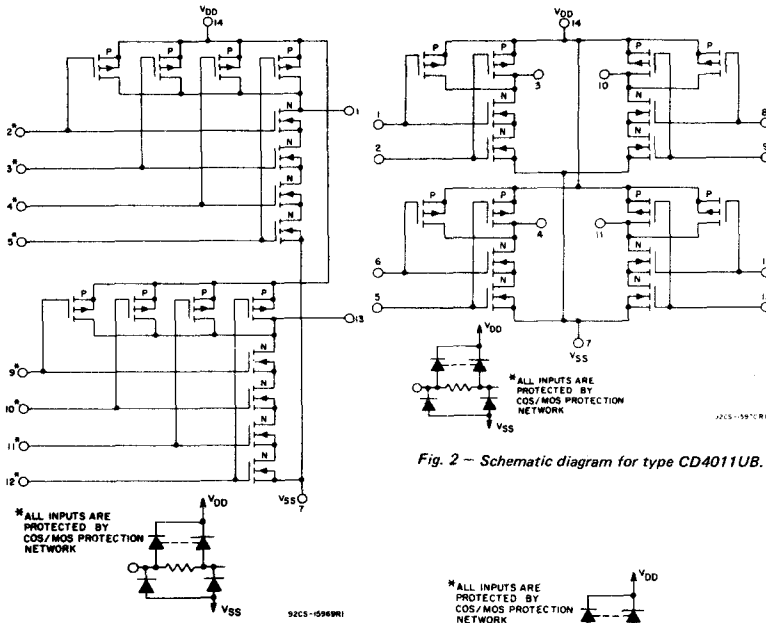
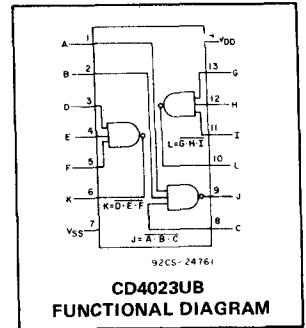
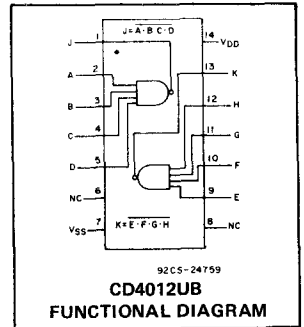
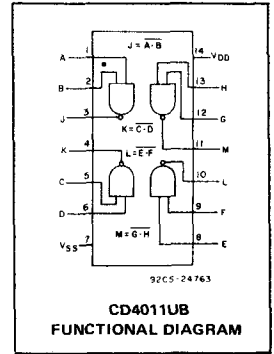
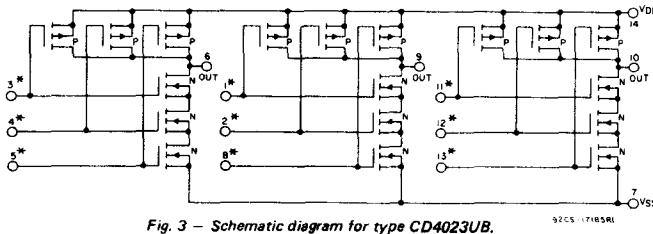

Fig. 1 – Schematic diagram for type CD4012UB.



### RECOMMENDED OPERATING CONDITIONS

For maximum reliability, nominal operating conditions should be selected so that operation is always within the following ranges.

CHARACTERISTIC	MIN.	MAX.	UNITS
Supply Voltage Range (For $T_A =$ Full Package Temperature Range)	3	18	V



# CD4011UB, CD4012UB, CD4023UB Types

## MAXIMUM RATINGS, Absolute-Maximum Values:

DC SUPPLY-VOLTAGE RANGE, ( $V_{DD}$ ) (Voltages referenced to $V_{SS}$ Terminal)	-0.5 to +20 V
INPUT VOLTAGE RANGE, ALL INPUTS	-0.5 to $V_{DD}$ +0.5 V
DC INPUT CURRENT, ANY ONE INPUT	$\pm 10$ mA
POWER DISSIPATION PER PACKAGE ( $P_D$ ):	
For $T_A = -40$ to $+60^\circ\text{C}$ (PACKAGE TYPE E)	500 mW
For $T_A = +60$ to $+85^\circ\text{C}$ (PACKAGE TYPE E)	Derate Linearly at $12\text{ mW}/^\circ\text{C}$ to 200 mW
For $T_A = -55$ to $+100^\circ\text{C}$ (PACKAGE TYPES D, F, K)	500 mW
For $T_A = +100$ to $+125^\circ\text{C}$ (PACKAGE TYPES D, F, K)	Derate Linearly at $12\text{ mW}/^\circ\text{C}$ to 200 mW
DEVICE DISSIPATION PER OUTPUT TRANSISTOR	
FOR $T_A =$ FULL PACKAGE-TEMPERATURE RANGE (All Package Types)	100 mW
OPERATING-TEMPERATURE RANGE ( $T_A$ ):	
PACKAGE TYPES D, F, K, H	$-55$ to $+125^\circ\text{C}$
PACKAGE TYPE E	$-40$ to $+85^\circ\text{C}$
STORAGE TEMPERATURE RANGE ( $T_{stg}$ )	$-65$ to $+150^\circ\text{C}$
LEAD TEMPERATURE (DURING SOLDERING):	
At distance $1/16 \pm 1/32$ inch ( $1.59 \pm 0.79$ mm) from case for 10 s max.	$+265^\circ\text{C}$

## STATIC ELECTRICAL CHARACTERISTICS

CHARACTERISTIC	CONDITIONS			LIMITS AT INDICATED TEMPERATURES ( $^\circ\text{C}$ )							UNITS
	$V_O$ (V)	$V_{IN}$ (V)	$V_{DD}$ (V)	Values at $-55$ , $+25$ , $+125$ Apply to D, F, K, H Packages Values at $-40$ , $+25$ , $+85$ Apply to E Package				$+25$			
				$-55$	$-40$	$+85$	$+125$	Min.	Typ.	Max.	
Quiescent Device Current, $I_{DD}$ Max.	-	0.5	5	0.25	0.25	7.5	7.5	-	0.01	0.25	$\mu\text{A}$
	-	0.10	10	0.5	0.5	15	15	-	0.01	0.5	
	-	0.15	15	1	1	30	30	-	0.01	1	
	-	0.20	20	5	5	150	150	-	0.02	5	
Output Low (Sink) Current $I_{OL}$ Min.	0.4	0.5	5	0.64	0.61	0.42	0.36	0.51	1	-	$\text{mA}$
	0.5	0.10	10	1.6	1.5	1.1	0.9	1.3	2.6	-	
	1.5	0.15	15	4.2	4	2.8	2.4	3.4	6.8	-	
Output High (Source) Current, $I_{OH}$ Min.	4.6	0.5	5	-0.64	-0.61	-0.42	-0.36	-0.51	-1	-	$\text{mA}$
	2.5	0.5	5	-2	-1.8	-1.3	-1.15	-1.6	-3.2	-	
	9.5	0.10	10	-1.6	-1.5	-1.1	-0.9	-1.3	-2.6	-	
Output Voltage: Low-Level, $V_{OL}$ Max.	-	0.5	5			0.05			0	0.05	V
	-	0.10	10			0.05			0	0.05	
	-	0.15	15			0.05			0	0.05	
Output Voltage: High-Level, $V_{OH}$ Min.	-	0.5	5			4.95			4.95	5	V
	-	0.10	10			9.95			9.95	10	
	-	0.15	15			14.95			14.95	15	
Input Low Voltage, $V_{IL}$ Max.	4.5	-	5			1			-	1	V
	9	-	10			2			-	2	
	13.5	-	15			2.5			-	2.5	
Input High Voltage, $V_{IH}$ Min.	0.5, 4.5	-	5			4			4	-	V
	1.9	-	10			8			8	-	
	1.5, 13.5	-	15			12.5			12.5	-	
Input Current $I_{IN}$ Max.		0.18	18	$\pm 0.1$	$\pm 0.1$	$\pm 1$	$\pm 1$	-	$\pm 10^{-5}$	$\pm 0.1$	$\mu\text{A}$

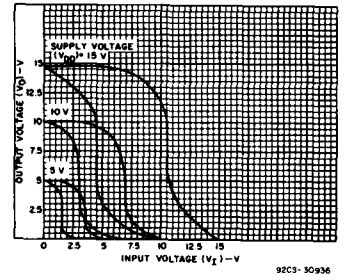

Fig. 4 - Minimum and maximum voltage transfer characteristics.

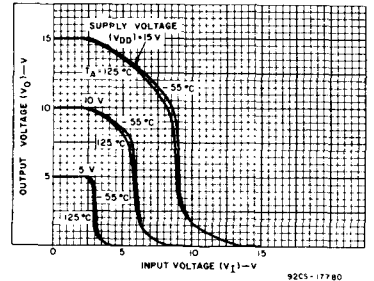

Fig. 5 - Typical voltage transfer characteristics as a function of temperature.

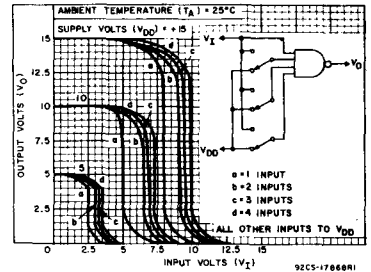

Fig. 6 - Typical multiple input switching transfer characteristics for CD4012UB.

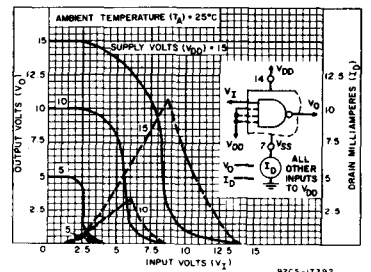

Fig. 7 - Typical current and voltage transfer characteristics.

# CD4011UB, CD4012UB, CD4023UB Types

## DYNAMIC ELECTRICAL CHARACTERISTICS

At  $T_A = 25^\circ\text{C}$ , Input  $t_r, t_f = 20\text{ ns}$ , and  $C_L = 50\text{ pF}$ ,  $R_L = 200\text{ k}\Omega$

CHARACTERISTIC	TEST CONDITIONS	ALL TYPES LIMITS		UNITS	
		$V_{DD}$ VOLTS	TYP.		MAX
Propagation Delay Time, $t_{PHL}, t_{PLH}$		5	60	120	ns
		10	30	60	
		15	25	50	
Transition Time, $t_{THL}, t_{TLH}$		5	100	200	ns
		10	50	100	
		15	40	80	
Input Capacitance, $C_{IN}$	Any Input		10	15	pF

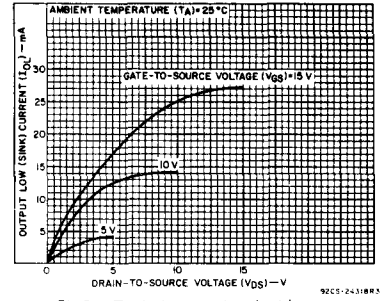

Fig. 8 - Typical output low (sink) current characteristics.

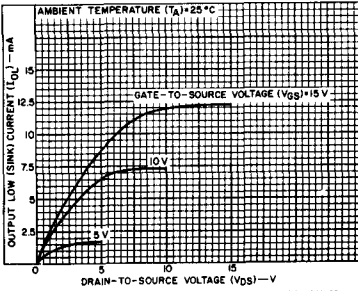

Fig. 9 - Minimum output low (sink) current characteristics.

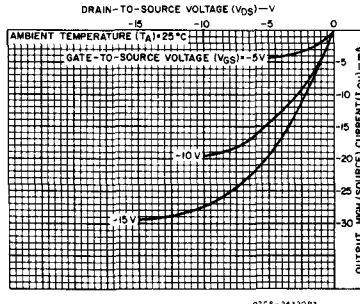

Fig. 10 - Typical output high (source) current characteristics.

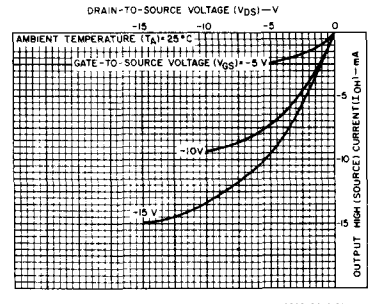

Fig. 11 - Minimum output high (source) current characteristics.

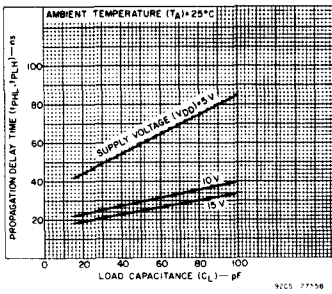

Fig. 12 - Typical propagation delay time vs. load capacitance.

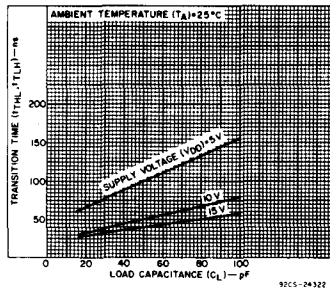

Fig. 13 - Typical transition time vs. load capacitance.

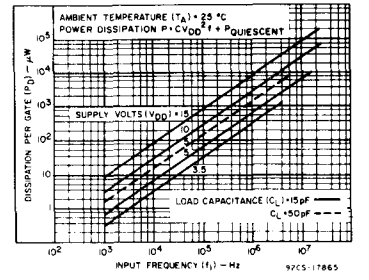

Fig. 14 - Typical power dissipation vs. frequency characteristics.

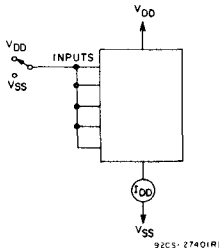

Fig. 15 - Quiescent device current test circuit.

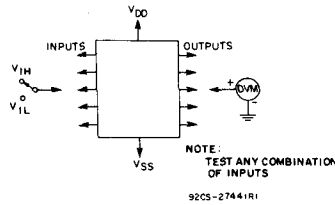

Fig. 16 - Input voltage test circuit.

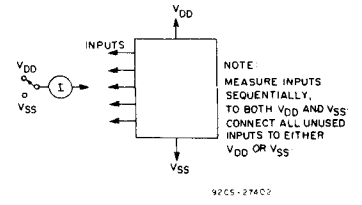
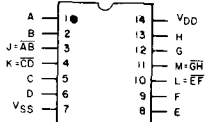

Fig. 17 - Input current test circuit.

# CD4011UB, CD4012UB, CD4023UB Types

## TERMINAL ASSIGNMENTS



92CS-24463

TOP VIEW  
CD4011UB

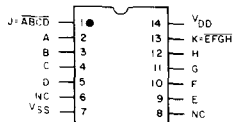

NC=NO CONNECTION

92CS-24454R1

TOP VIEW  
CD4012UB

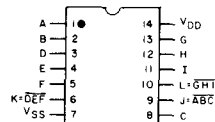

92CS-24465

TOP VIEW  
CD4023UB

## CHIP PHOTOGRAPHS Dimensions and Pad Layouts

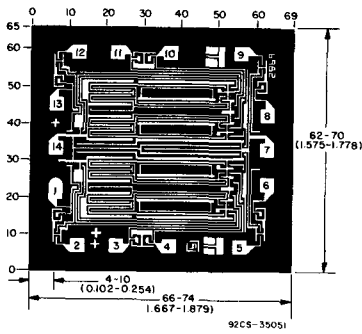

CD4011UBH

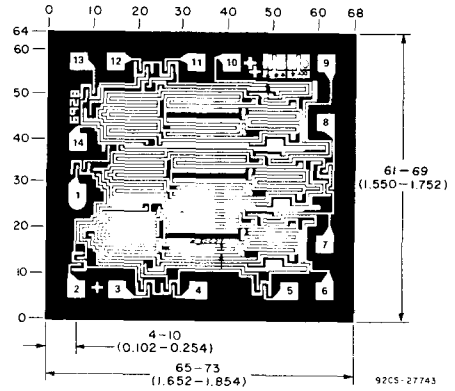

CD4023UBH

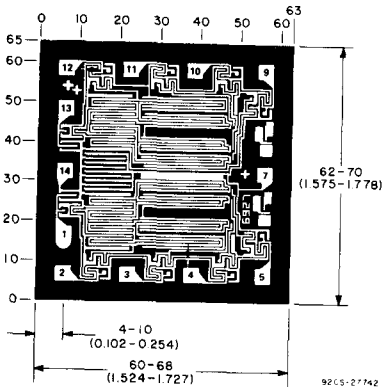

CD4012UBH

Dimensions in parentheses are in millimeters and are derived from the basic inch dimensions as indicated. Grid graduations are in mils ( $10^{-3}$  inch).

The photographs and dimensions of each CMOS chip represent a chip when it is part of the wafer. When the wafer is separated into individual chips, the angle of cleavage may vary with respect to the chip face for different chips. The actual dimensions of the isolated chip, therefore, may differ slightly from the nominal dimensions shown. The user should consider a tolerance of  $-3$  mils to  $+16$  mils applicable to the nominal dimensions shown.

# CD4013B Types

## CMOS Dual 'D'-Type Flip-Flop

High-Voltage Types (20-Volt Rating)

The RCA-CD4013B consists of two identical, independent data-type flip-flops. Each flip-flop has independent data, set, reset, and clock inputs and Q and  $\bar{Q}$  outputs. These devices can be used for shift register applications, and, by connecting  $\bar{Q}$  output to the data input, for counter and toggle applications. The logic level present at the D input is transferred to the Q output during the positive-going transition of the clock pulse. Setting or resetting is independent of the clock and is accomplished by a high level on the set or reset line, respectively.

The CD4013B types are supplied in 14-lead hermetic dual-in-line ceramic packages (D and F suffixes), 14-lead dual-in-line plastic packages (E suffix), 14-lead ceramic flat packages (K suffix), and in chip form (H suffix).

### Features:

- Set-Reset capability
- Static flip-flop operation — retains state indefinitely with clock level either "high" or "low"
- Medium-speed operation — 16 MHz (typ.) clock toggle rate at 10V
- Standardized symmetrical output characteristics
- 100% tested for quiescent current at 20 V
- Maximum input current of 1  $\mu$ A at 18 V over full package temperature range; 100 nA at 18 V and 25°C
- Noise margin (over full package temperature range): 1 V at  $V_{DD}=5$  V  
2 V at  $V_{DD}=10$  V  
2.5 V at  $V_{DD}=15$  V
- 5-V, 10-V, and 15-V parametric ratings
- Meets all requirements of JEDEC Tentative Standard No. 13A, "Standard Specifications for Description of 'B' Series CMOS Devices"

### Applications:

- Registers, counters, control circuits

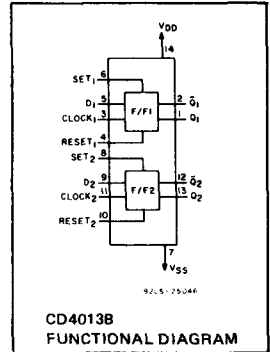

### RECOMMENDED OPERATING CONDITIONS

At  $T_A = 25^\circ\text{C}$ , Except as Noted. For maximum reliability, nominal operating conditions should be selected so that operation is always within the following ranges:

CHARACTERISTIC	$V_{DD}$ (V)	LIMITS		UNITS
		MIN.	MAX.	
Supply-Voltage Range (For $T_A =$ Full Package Temperature Range)	—	3	18	V
Data Setup Time $t_S$	5 10 15	40	—	ns
Clock Pulse Width $t_W$	5 10 15	140 60 40	—	ns
Clock Input Frequency $f_{CL}$	5 10 15	dc	3.5 8 12	MHz
Clock Rise or Fall Time $t_{rCL}, * t_{fCL}$	5 10 15	—	70 6 2	$\mu$ s
Set or Reset Pulse Width $t_W$	5 10 15	180 80 50	—	ns

\*If more than one unit is cascaded in a parallel clocked operation,  $t_{fCL}$  should be made less than or equal to the sum of the fixed propagation delay time at 15 pF and the transition time of the output driving stage for the estimated capacitive load.

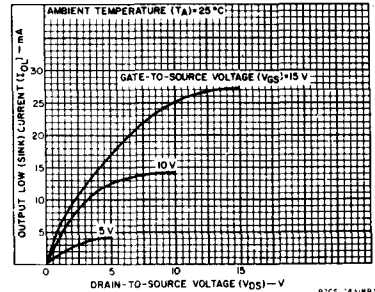

Fig. 1 — Typical output low (sink) current characteristics.

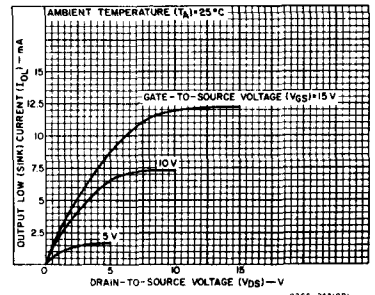

Fig. 2 — Minimum output low (sink) current characteristics.

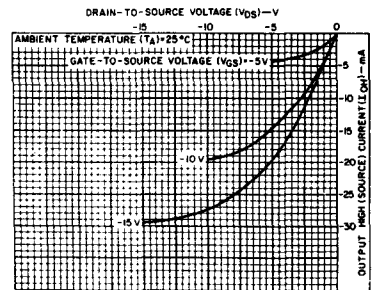

Fig. 3 — Typical output high (source) current characteristics.

# CD4013B Types

## STATIC ELECTRICAL CHARACTERISTICS

CHARACTERISTIC	CONDITIONS			LIMITS AT INDICATED TEMPERATURES (°C)								UNITS
	V <sub>O</sub> (V)	V <sub>IN</sub> (V)	V <sub>DD</sub> (V)	Values at -55,+25,+125 Apply to D,F,K,H Pkgs.				Values at -40,+25,+85 Apply to E Pkgs.				
				-55	-40	+85	+125	+25				
								Min.	Typ.	Max.		
Quiescent Device Current I <sub>DD</sub> Max.	-	0.5, 0.10, 0.15, 0.20	5, 10, 15, 20	1, 2, 4, 20	1, 2, 4, 20	30, 60, 120, 600	30, 60, 120, 600	-	0.02	0.02		1, 2, 4, 20
Output Low (Sink) Current I <sub>OL</sub> Min.	0.4, 0.5, 1.5	0.5, 0.10, 0.15	5, 10, 15	0.64, 1.6, 4.2	0.61, 1.5, 4	0.42, 1.1, 2.8	0.36, 0.9, 2.4	0.51, 1.3, 3.4	1, 2.6, 6.8	-		-
Output High (Source) Current I <sub>OH</sub> Min.	4.6, 2.5, 9.5, 13.5	0.5, 0.5, 0.10, 0.15	5, 5, 10, 15	-0.64, -2, -1.6, -4.2	-0.61, -1.8, -1.5, -4	-0.42, -1.3, -1.1, -2.8	-0.36, -1.15, -0.9, -2.4	-0.51, -1.6, -1.3, -3.4	-1, -3.2, -2.6, -6.8	-		-
Output Voltage: Low-Level, V <sub>OL</sub> Max.	-	0.5, 0.10, 0.15	5, 10, 15	0.05				-	0	0.05		-
Output Voltage: High-Level, V <sub>OH</sub> Min.	-	0.5, 0.10, 0.15	5, 10, 15	4.95, 9.95, 14.95				4.95, 9.95, 14.95	5, 10, 15	-		-
Input Low Voltage, V <sub>IL</sub> Max.	0.5, 1.9, 1.5, 13.5	-	5, 10, 15	1.5, 3, 4				-	-	1.5, 3, 4		-
Input High Voltage, V <sub>IH</sub> Min.	0.5, 1.9, 1.5, 13.5	-	5, 10, 15	3.5, 7, 11				3.5, 7, 11	-	-		-
Input Current, I <sub>IN</sub> Max.	-	0.18	18	±0.1	±0.1	±1	±1	-	±10 <sup>-5</sup>	±0.1		μA

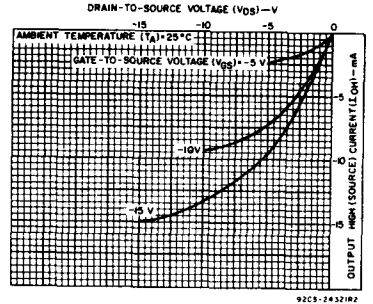

Fig. 4 - Minimum output high (source) current characteristics.

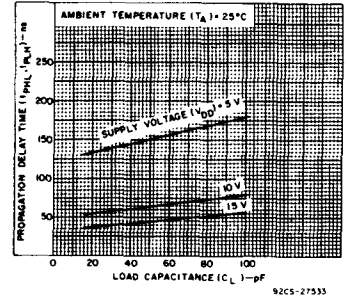

Fig. 5 - Typical propagation delay time vs. load capacitance (CLOCK or SET to Q, CLOCK or RESET to Q).

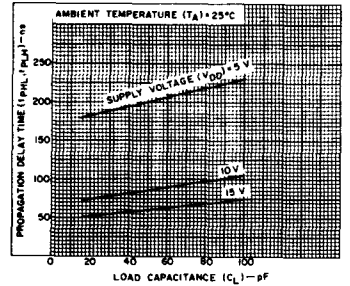

Fig. 6 - Typical propagation delay time vs. load capacitance (SET to Q or RESET to Q).

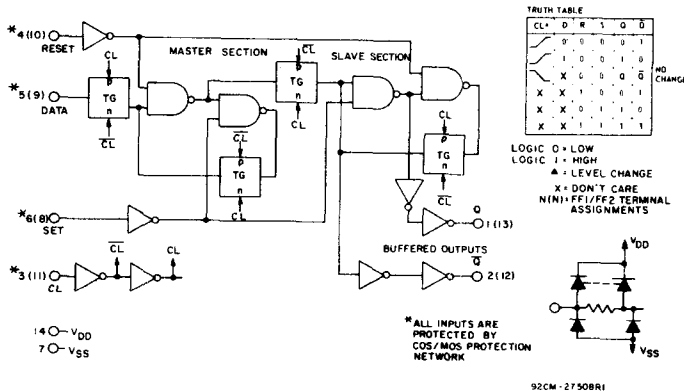

Fig. 7 - Logic diagram and truth table for CD4013B (one of two identical flip-flops).

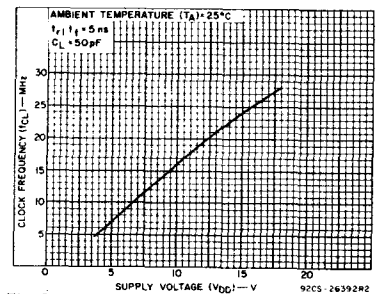

Fig. 8 - Typical maximum clock frequency vs. supply voltage.

# CD4013B Types

## MAXIMUM RATINGS, Absolute-Maximum Values:

DC SUPPLY-VOLTAGE RANGE, ( $V_{DD}$ ) (Voltages referenced to $V_{SS}$ Terminal)	-0.5 to +20 V
INPUT VOLTAGE RANGE, ALL INPUTS	-0.5 to $V_{DD} + 0.5$ V
DC INPUT CURRENT, ANY ONE INPUT	$\pm 10$ mA
POWER DISSIPATION PER PACKAGE ( $P_D$ ):	
For $T_A = -40$ to $+60^\circ\text{C}$ (PACKAGE TYPE E)	500 mW
For $T_A = +60$ to $+85^\circ\text{C}$ (PACKAGE TYPE E)	Derate Linearly at 12 mW/ $^\circ\text{C}$ to 200 mW
For $T_A = -55$ to $+100^\circ\text{C}$ (PACKAGE TYPES D, F, K)	500 mW
For $T_A = +100$ to $+125^\circ\text{C}$ (PACKAGE TYPES D, F, K)	Derate Linearly at 12 mW/ $^\circ\text{C}$ to 200 mW
DEVICE DISSIPATION PER OUTPUT TRANSISTOR FOR $T_A = \text{FULL PACKAGE-TEMPERATURE RANGE}$ (All Package Types)	100 mW
OPERATING-TEMPERATURE RANGE ( $T_A$ ):	
PACKAGE TYPES D, F, K, H	-55 to $+125^\circ\text{C}$
PACKAGE TYPE E	-40 to $+85^\circ\text{C}$
STORAGE TEMPERATURE RANGE ( $T_{stg}$ )	-65 to $+150^\circ\text{C}$
LEAD TEMPERATURE (DURING SOLDERING):	
At distance $1/16 \pm 1/32$ inch ( $1.59 \pm 0.79$ mm) from case for 10 s max.	$+265^\circ\text{C}$

## DYNAMIC ELECTRICAL CHARACTERISTICS

At  $T_A = 25^\circ\text{C}$ ; Input  $t_r, t_f = 20$  ns,  $C_L = 50$  pF,  $R_L = 200$  k $\Omega$

CHARACTERISTIC	TEST CONDITIONS	LIMITS			UNITS	
		$V_{DD}$ (V)	MIN.	TYP.		MAX.
Propagation Delay Time: Clock to Q or $\bar{Q}$ Outputs $t_{PHL}, t_{PLH}$		5	-	150	300	ns
		10	-	65	130	
		15	-	45	90	
Set to Q or Reset to $\bar{Q}$ $t_{PLH}$		5	-	150	300	ns
		10	-	65	130	
		15	-	45	90	
Set to $\bar{Q}$ or Reset to Q $t_{PHL}$		5	-	200	400	ns
		10	-	85	170	
		15	-	60	120	
Transition Time $t_{THL}, t_{TLH}$		5	-	100	200	ns
		10	-	50	100	
		15	-	40	80	
Maximum Clock Input Frequency Frequency # $f_{CL}$		5	3.5	7	-	MHz
		10	8	16	-	
		15	12	24	-	
Minimum Clock Pulse Width $t_W$		5	-	70	140	ns
		10	-	30	60	
		15	-	20	40	
Minimum Set or Reset Pulse Width $t_W$		5	-	90	180	ns
		10	-	40	80	
		15	-	25	50	
Minimum Data Setup Time $t_S$		5	-	20	40	ns
		10	-	10	20	
		15	-	7	15	
Clock Input Rise or Fall Time $t_{rCL}, t_{fCL}$		5	-	-	70	$\mu\text{s}$
		10	-	-	6	
		15	-	-	2	
Input Capacitance $C_{IN}$	Any Input	-	5	7.5	pF	

#Input  $t_r, t_f = 5$  ns.

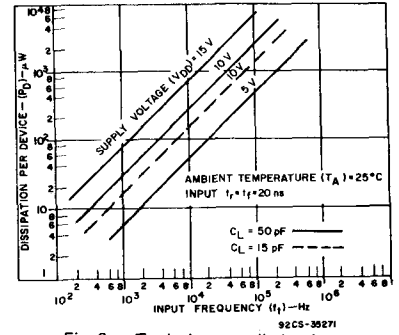

Fig. 9 - Typical power dissipation vs. frequency.

## TEST CIRCUITS

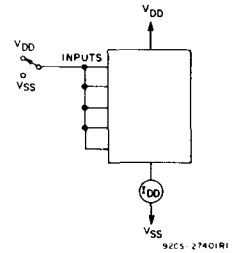

Fig. 10 - Quiescent device current.

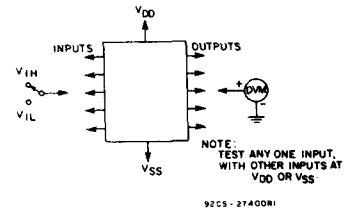

Fig. 11 - Input voltage.

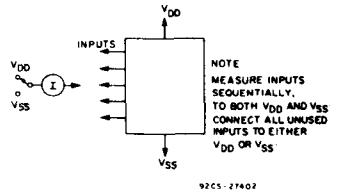
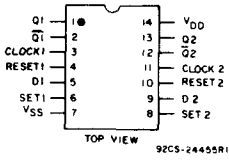

Fig. 12 - Input current.



TOP VIEW 92CS-24455R1  
TERMINAL ASSIGNMENT

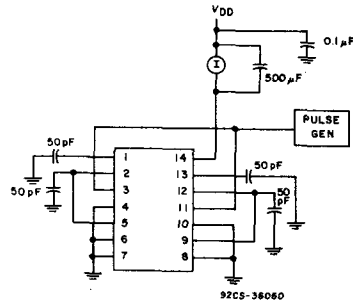
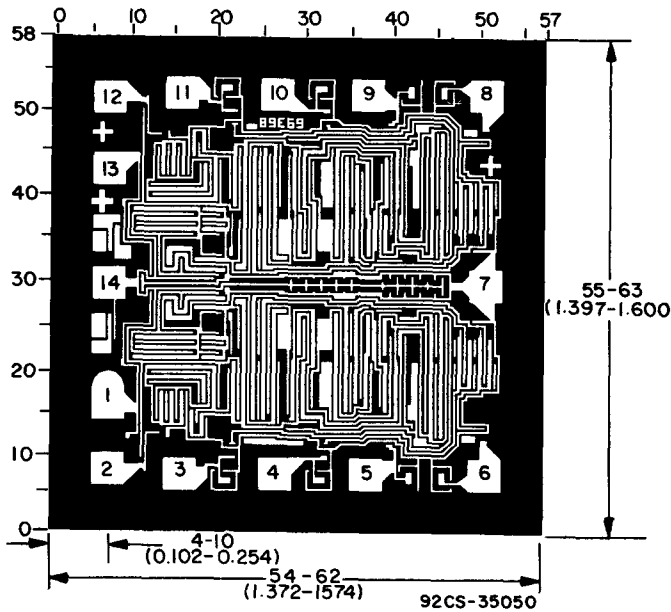

Fig. 13—Dynamic power dissipation test circuit.

## DIMENSIONS AND PAD LAYOUT FOR CD4013BH



Dimensions in parentheses are in millimeters and are derived from the basic inch dimensions as indicated. Grid graduations are in mils ( $10^{-3}$  inch).

The photographs and dimensions of each CMOS chip represent a chip when it is part of the wafer. When the wafer is separated into individual chips, the angle of cleavage may vary with respect to the chip face for different chips. The actual dimensions of the isolated chip, therefore, may differ slightly from the nominal dimensions shown. The user should consider a tolerance of  $-3$  mils to  $+15$  mils applicable to the nominal dimensions shown.

## CD4014B, CD4021B Types

### CMOS 8-Stage Static Shift Registers

High-Voltage Types (20-Volt Rating)

#### CD4014B:

Synchronous Parallel or  
Serial Input/Serial Output

#### CD4021B:

Asynchronous Parallel Input or  
Synchronous Serial Input/Serial Output

The RCA-CD4014B and CD4021B series types are 8-stage parallel- or serial-input/serial-output registers having common CLOCK and PARALLEL/SERIAL CONTROL inputs, a single SERIAL data input, and individual parallel "JAM" inputs to each register stage. Each register stage is a D-type, master-slave flip-flop. In addition to an output from stage 8, "Q" outputs are also available from stages 6 and 7. Parallel as well as serial entry is made into the register synchronously with the positive clock line transition in the CD4014B. In the CD4021B serial entry is synchronous with the clock but parallel entry is asynchronous. In both types, entry is controlled by the PARALLEL/SERIAL CONTROL input. When the PARALLEL/SERIAL CONTROL input is low, data is serially shifted into the 8-stage register synchronously with the positive transition of the clock line. When the PARALLEL/SERIAL CONTROL input is high, data is jammed into the 8-stage register via the parallel input lines and synchronous with the positive transition of the clock line. In the CD4021B, the CLOCK input of the internal stage is "forced" when asynchronous parallel entry is made. Register expansion using multiple packages is permitted.

The CD4014B and CD4021B series types are supplied in 16-lead hermetic dual-in-line ceramic packages (D and F suffixes), 16-lead dual-in-line plastic packages (E suffix), 16-lead ceramic flat packages (K suffix), and in chip form (H suffix).

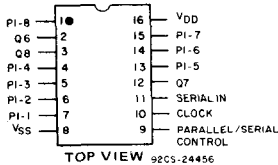

TOP VIEW 92CS-24456  
TERMINAL DIAGRAM  
CD4014B, CD4021B

#### Features:

- Medium-speed operation . . . 12 MHz (typ.) clock rate at  $V_{DD}-V_{SS} = 10\text{ V}$
- Fully static operation
- 8 master-slave flip-flops plus output buffering and control gating
- 100% tested for quiescent current at 20 V
- Maximum input current of  $1\ \mu\text{A}$  at 18 V over full package-temperature range; 100 nA at 18 V and 25°C
- Noise margin (full package-temperature range) =  $1\text{ V}$  at  $V_{DD} = 5\text{ V}$   
 $2\text{ V}$  at  $V_{DD} = 10\text{ V}$   
 $2.5\text{ V}$  at  $V_{DD} = 15\text{ V}$
- Standardized, symmetrical output characteristics
- 5-V, 10-V, and 15-V parametric ratings
- Meets all requirements of JEDEC Tentative Standard No. 13A, "Standard Specifications for Description of 'B' Series CMOS Devices"

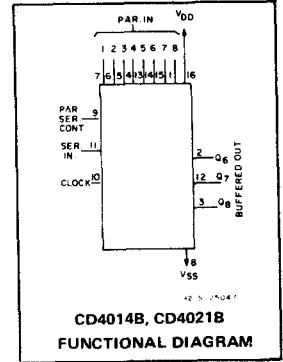

CD4014B, CD4021B  
FUNCTIONAL DIAGRAM

#### Applications:

- Parallel input/serial output data queueing
- Parallel to serial data conversion
- General-purpose register

#### RECOMMENDED OPERATING CONDITIONS AT $T_A = 25^\circ\text{C}$ , Unless Otherwise Specified

For maximum reliability, nominal operating conditions should be selected so that operation is always within the following ranges.

CHARACTERISTIC	$V_{DD}$ (V)	LIMITS		UNITS			
		Min.	Max.				
Supply-Voltage Range ( $T_A = \text{Full Package-Temperature Range}$ )	—	3	18	V			
Clock Pulse Width, $t_{W}$	5	180	—	ns			
	10	80	—				
	15	50	—				
Clock Frequency, $f_{CL}$	5	—	3	MHz			
	10	—	6				
	15	—	8.5				
Clock Rise and Fall Time, $t_{rCL}, t_{fCL}$	5	—	15	$\mu\text{s}$			
	10	—	15				
	15	—	15				
Set-up Time, $t_s$ :	5	120	—	ns			
					Serial Input (ref. to CL)	80	—
					15	60	—
Parallel Inputs CD4014B (ref. to CL)	5	80	—	ns			
					10	50	—
					15	40	—
Parallel Inputs CD4021B (ref. to P/S)	5	50	—	ns			
					10	30	—
					15	20	—
Parallel/Serial Control CD4014B (ref. to CL)	5	180	—	ns			
					10	80	—
					15	60	—
Parallel/Serial Pulse Width, $t_{W}$ (CD4021B)	5	160	—	ns			
					10	80	—
					15	50	—
Parallel/Serial Removal Time, $t_{REM}$ (CD4021B)	5	280	—	ns			
					10	140	—
					15	100	—



# CD4014B, CD4021B Types

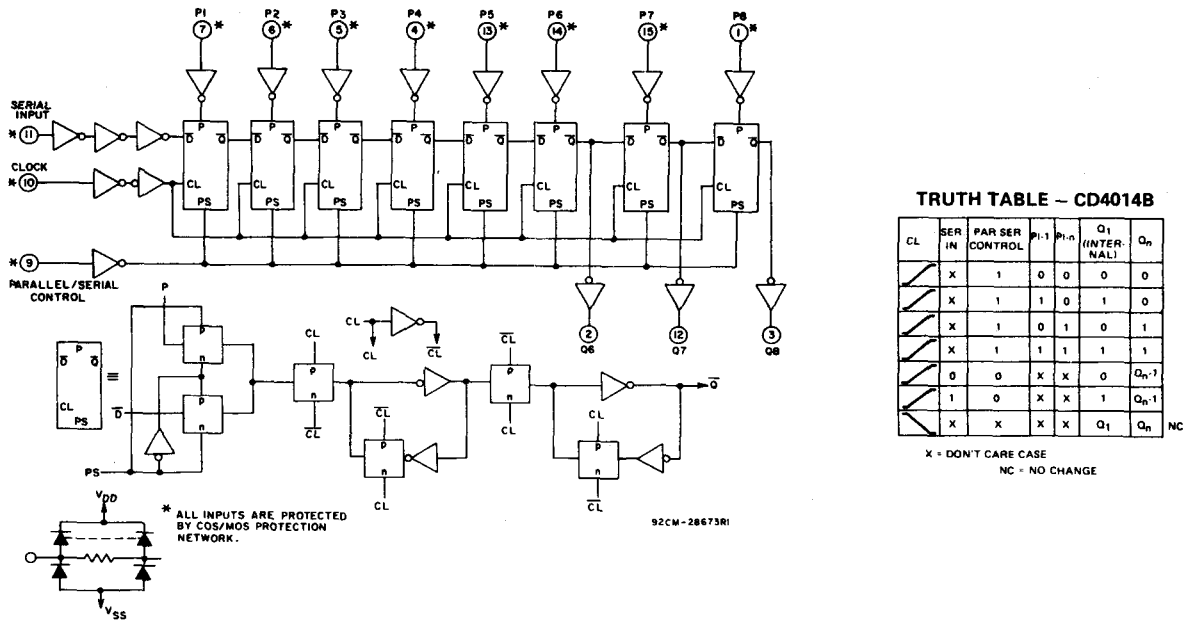

Fig. 1 - Logic diagram for CD4014B.

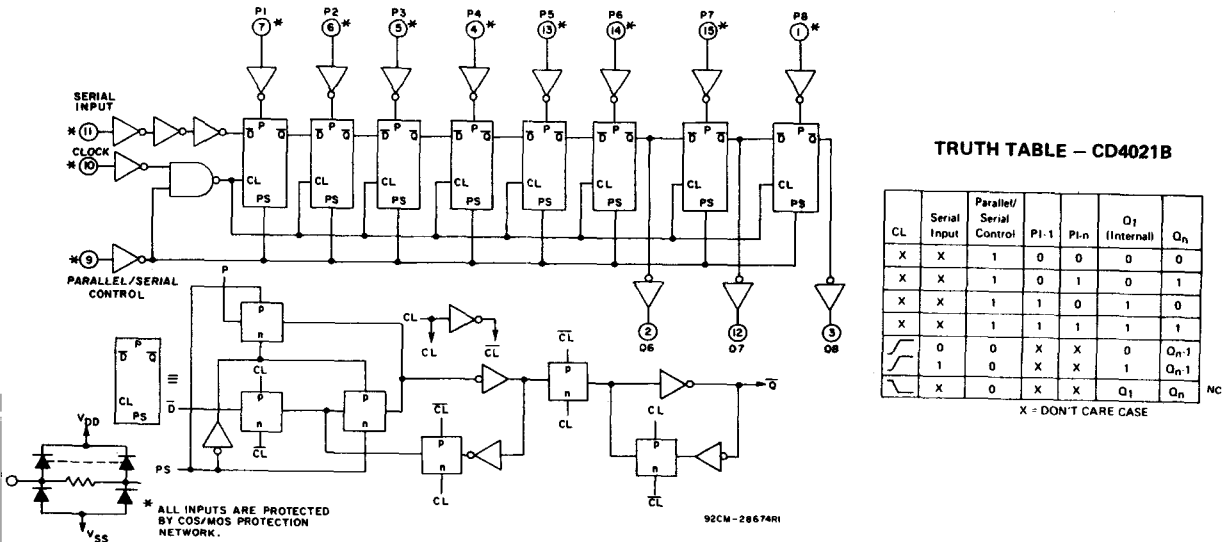

Fig. 2 - Logic diagram for CD4021B.

# CD4014B, CD4021B Types

## MAXIMUM RATINGS, Absolute-Maximum Values:

DC SUPPLY-VOLTAGE RANGE, ( $V_{DD}$ ) (Voltages referenced to $V_{SS}$ Terminal)	-0.5 to +20 V
INPUT VOLTAGE RANGE, ALL INPUTS	-0.5 to $V_{DD} + 0.5$ V
DC INPUT CURRENT, ANY ONE INPUT	$\pm 10$ mA
POWER DISSIPATION PER PACKAGE ( $P_D$ ):	
For $T_A = -40$ to $+60^\circ\text{C}$ (PACKAGE TYPE E)	500 mW
For $T_A = +80$ to $+85^\circ\text{C}$ (PACKAGE TYPE E)	Derate Linearly at 12 mW/ $^\circ\text{C}$ to 200 mW
For $T_A = -55$ to $+100^\circ\text{C}$ (PACKAGE TYPES D, F, K)	500 mW
For $T_A = +100$ to $+125^\circ\text{C}$ (PACKAGE TYPES D, F, K)	Derate Linearly at 12 mW/ $^\circ\text{C}$ to 200 mW
DEVICE DISSIPATION PER OUTPUT TRANSISTOR:	
For $T_A = \text{FULL PACKAGE-TEMPERATURE RANGE (All Package Types)}$	100 mW
OPERATING-TEMPERATURE RANGE ( $T_A$ ):	
PACKAGE TYPES D, F, K, H	-55 to $+125^\circ\text{C}$
PACKAGE TYPE E	-40 to $+85^\circ\text{C}$
STORAGE TEMPERATURE RANGE ( $T_{stg}$ )	-65 to $+150^\circ\text{C}$
LEAD TEMPERATURE (DURING SOLDERING):	
At distance 1/16 $\pm$ 1/32 inch (1.59 $\pm$ 0.79 mm) from case for 10 s max.	$+265^\circ\text{C}$

## STATIC ELECTRICAL CHARACTERISTICS

CHARACTERISTIC	CONDITIONS			LIMITS AT INDICATED TEMPERATURES ( $^\circ\text{C}$ )							UNITS
				Values at -55, +25, +125 Apply to D, F, K, H, Packages Values at -40, +25, +85 Apply to E Package							
	$V_O$ (V)	$V_{IN}$ (V)	$V_{DD}$ (V)	-55	-40	+85	+125	+25			
								Min.	Typ.	Max.	
Quiescent Device Current, $I_{DD}$ Max.	-	0.5	5	5	5	150	150	-	0.04	5	$\mu\text{A}$
	-	0.10	10	10	10	300	300	-	0.04	10	
	-	0.15	15	20	20	600	600	-	0.04	20	
	-	0.20	20	100	100	3000	3000	-	0.08	100	
Output Low (Sink) Current $I_{OL}$ Min.	0.4	0.5	5	0.64	0.61	0.42	0.36	0.51	1	-	mA
	0.5	0.10	10	1.6	1.5	1.1	0.9	1.3	2.6	-	
	1.5	0.15	15	4.2	4	2.8	2.4	3.4	6.8	-	
Output High (Source) Current, $I_{OH}$ Min.	4.6	0.5	5	-0.64	-0.61	-0.42	-0.36	-0.51	-1	-	mA
	2.5	0.5	5	-2	-1.8	-1.3	-1.15	-1.6	-3.2	-	
	9.5	0.10	10	-1.6	-1.5	-1.1	-0.9	-1.3	-2.6	-	
	13.5	0.15	15	-4.2	-4	-2.8	-2.4	-3.4	-6.8	-	
Output Voltage: Low-Level, $V_{OL}$ Max.	-	0.5	5	0.05			-	0	0.05	-	V
	-	0.10	10	0.05			-	0	0.05	-	
	-	0.15	15	0.05			-	0	0.05	-	
Output Voltage: High-Level, $V_{OH}$ Min.	-	0.5	5	4.95			4.95	5	-	-	V
	-	0.10	10	9.95			9.95	10	-	-	
	-	0.15	15	14.95			14.95	15	-	-	
Input Low Voltage $V_{IL}$ Max.	0.5, 4.5	-	5	1.5			-	-	1.5	-	V
	1.9	-	10	3			-	-	3	-	
	1.5, 13.5	-	15	4			-	-	4	-	
Input High Voltage, $V_{IH}$ Min.	0.5, 4.5	-	5	3.5			3.5	7	-	-	V
	1.9	-	10	7			7	7	-	-	
	1.5, 13.5	-	15	11			11	11	-	-	
Input Current $I_{IN}$ Max.	-	0.18	18	$\pm 0.1$	$\pm 0.1$	$\pm 1$	$\pm 1$	-	$\pm 10^{-5}$	$\pm 0.1$	$\mu\text{A}$

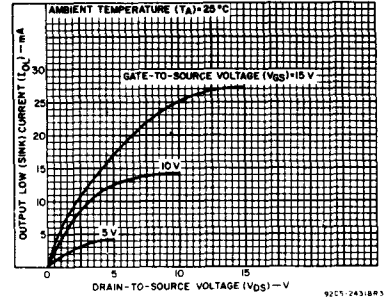

Fig. 3 - Typical output low (sink) current characteristics.

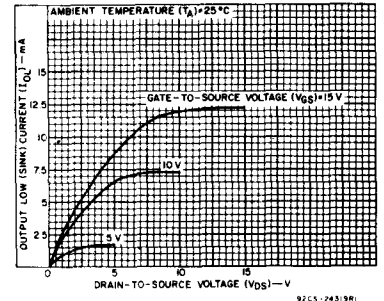

Fig. 4 - Minimum output low (sink) current characteristics.

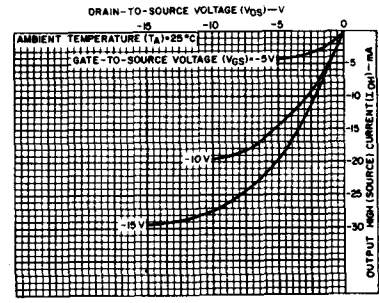

Fig. 5 - Typical output high (source) current characteristics.

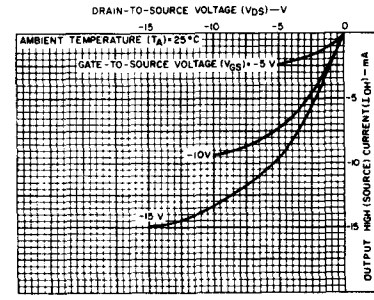

Fig. 6 - Minimum output high (source) current characteristics.

# CD4014B, CD4021B Types

DYNAMIC ELECTRICAL CHARACTERISTICS at  $T_A=25^\circ\text{C}$ , Input  $t_r, t_f=20\text{ ns}$ ,  $C_L=50\text{ pF}$ ,  $R_L=200\text{ K}\Omega$

CHARACTERISTIC	TEST CONDITIONS	LIMITS			UNITS
		$V_{DD}$ (V)	Min.	Typ.	
Propagation Delay Time, $t_{PLH}, t_{PHL}$	5	—	160	320	ns
	10	—	80	160	
	15	—	60	120	
Transition Time, $t_{THL}, t_{TLH}$	5	—	100	200	ns
	10	—	50	100	
	15	—	40	80	
Maximum Clock Input Frequency, $f_{CL}$	5	3	6	—	MHz
	10	6	12	—	
	15	8.5	17	—	
Minimum Clock Pulse Width, $t_W$	5	—	90	180	ns
	10	—	40	80	
	15	—	25	50	
Clock Rise and Fall Time, $t_r, t_f$ *	5	—	—	15	$\mu\text{s}$
	10	—	—	15	
	15	—	—	15	
Minimum Set-up Time, $t_s$ : Serial Input (ref. to CL)	5	—	60	120	ns
	10	—	40	80	
	15	—	30	60	
Parallel Inputs CD4014B (ref. to CL)	5	—	40	80	ns
	10	—	25	50	
	15	—	20	40	
Parallel Inputs CD4021B (ref. to P/S)	5	—	25	50	ns
	10	—	15	30	
	15	—	10	20	
Parallel/Serial Control CD4014B (ref. to CL)	5	—	90	180	ns
	10	—	40	80	
	15	—	30	60	
Minimum Hold Time, $t_H$ : Serial In, Parallel In, Parallel/Serial Control	5	—	—	0	ns
	10	—	—	0	
	15	—	—	0	
Minimum P/S Pulse Width, $t_{WH}$ (CD4021B)	5	—	80	160	ns
	10	—	40	80	
	15	—	25	50	
Minimum P/S Removal Time, $t_{REM}$ CD4021B (ref. to CL)	5	—	140	280	ns
	10	—	70	140	
	15	—	50	100	
Average Input Capacitance, $C_I$	Any Input	—	5	7.5	pF

\* If more than one unit is cascaded  $t_r, t_f$  should be made less than or equal to the sum of the transition time and the fixed propagation delay of the output of the driving stage for the estimated capacitive load.

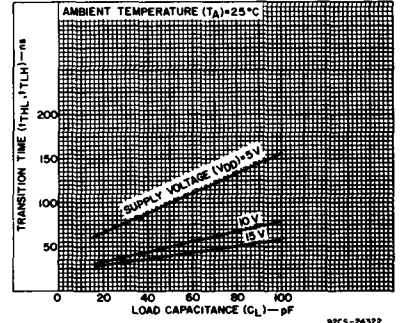

Fig. 7 — Typical transition time as a function of load capacitance.

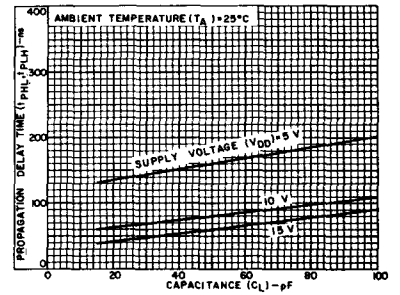

Fig. 8 — Typical propagation delay time as a function of load capacitance.

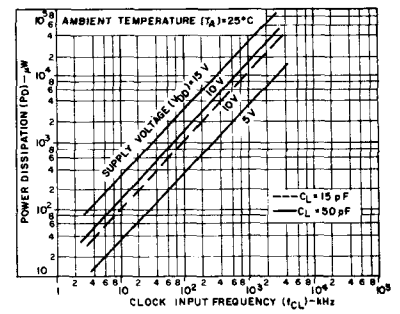

Fig. 9 — Typical dynamic power dissipation as a function of clock input frequency.

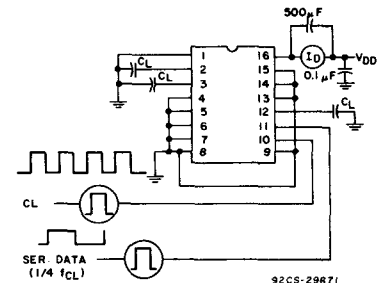

Fig. 10 — Dynamic power dissipation test circuit.

# CD4014B, CD4021B Types

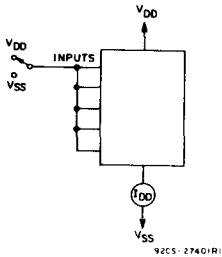

Fig. 11 - Quiescent device current test circuit.

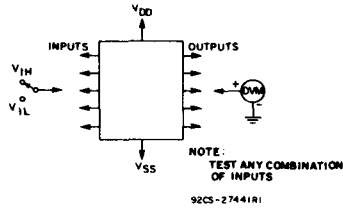

Fig. 12 - Input voltage test circuit.

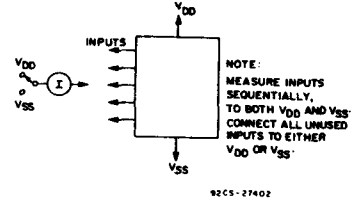
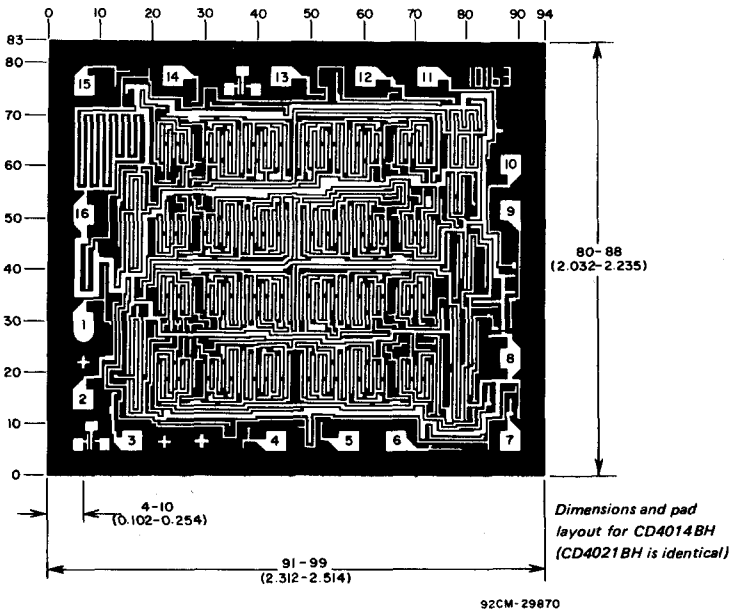

Fig. 13 - Input current test circuit.



The photographs and dimensions of each CMOS chip represent a chip when it is part of the wafer. When the wafer is separated into individual chips, the angle of cleavage may vary with respect to the chip face for different chips. The actual dimensions of the isolated chip, therefore, may differ slightly from the nominal dimensions shown. The user should consider a tolerance of  $-3$  mils to  $+16$  mils applicable to the nominal dimensions shown.

Dimensions in parentheses are in millimeters and are derived from the basic inch dimensions as indicated. Grid graduations are in mils ( $10^{-3}$  inch).

# CMOS Dual 4-Stage Static Shift Register

With Serial Input/Parallel Output  
High-Voltage Types (20-Volt Rating)

The RCA-CD4015B consists of two identical, independent, 4-stage serial-input/parallel-output registers. Each register has independent CLOCK and RESET inputs as well as a single serial DATA input. "Q" outputs are available from each of the four stages on both registers. All register stages are D-type, master-slave flip-flops. The logic level present at the DATA input is transferred into the first register stage and shifted over one stage at each positive-going clock transition. Resetting of all stages is accomplished by a high level on the reset line. Register expansion to 8 stages using one CD4015B package, or to more than 8 stages using additional CD4015B's is possible.

The CD4015B-series types are supplied in 16-lead hermetic dual-in-line ceramic packages (D and F suffixes), 16-lead dual-in-line plastic package (E suffix), 16-lead ceramic flat package (K suffix), and in chip form (H suffix).

**Features:**

- Medium speed operation . . . . . 12 MHz (typ.) clock rate at  $V_{DD} - V_{SS} = 10\text{ V}$
- Fully static operation
- 8 master-slave flip-flops plus input and output buffering
- 100% tested for quiescent current at 20 V
- 5-V, 10-V, and 15-V parametric ratings
- Standardized, symmetrical output characteristics
- Maximum input current of 1  $\mu\text{A}$  at 18 V over full package-temperature range; 100 nA at 18 V and 25°C
- Noise margin (full package-temperature range) =
  - 1 V at  $V_{DD} = 5\text{ V}$
  - 2 V at  $V_{DD} = 10\text{ V}$
  - 2.5 V at  $V_{DD} = 15\text{ V}$
- Meets all requirements of JEDEC Tentative Standard No. 13A, "Standard Specifications for Description of 'B' Series CMOS Devices"

**Applications:**

- Serial-input/parallel-output data queuing
- Serial to parallel data conversion
- General-purpose register

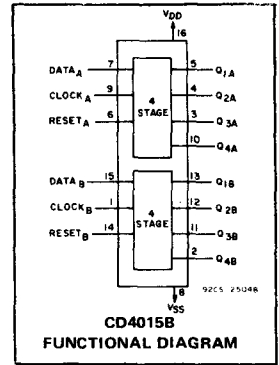

TERMINAL DIAGRAM

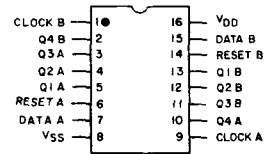

92CS-24457

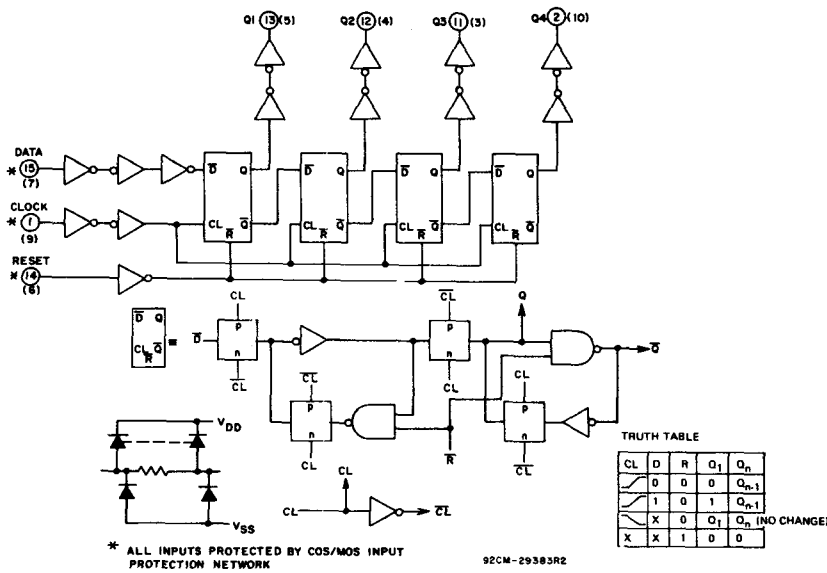

Fig. 1 - Logic diagram (1 register).

# CD4015B Types

## MAXIMUM RATINGS, Absolute-Maximum Values:

DC SUPPLY-VOLTAGE RANGE, ( $V_{DD}$ ) (Voltages referenced to $V_{SS}$ Terminal)	-0.5 to +20 V
INPUT VOLTAGE RANGE, ALL INPUTS	-0.5 to $V_{DD} + 0.5$ V
DC INPUT CURRENT, ANY ONE INPUT	$\pm 10$ mA
POWER DISSIPATION PER PACKAGE ( $P_D$ ):	
For $T_A = -40$ to $+60^\circ\text{C}$ (PACKAGE TYPE E)	500 mW
For $T_A = +60$ to $+85^\circ\text{C}$ (PACKAGE TYPE E)	Derate Linearly at 12 mW/ $^\circ\text{C}$ to 200 mW
For $T_A = -55$ to $+100^\circ\text{C}$ (PACKAGE TYPES D, F, K)	500 mW
For $T_A = +100$ to $+125^\circ\text{C}$ (PACKAGE TYPES D, F, K)	Derate Linearly at 12 mW/ $^\circ\text{C}$ to 200 mW
DEVICE DISSIPATION PER OUTPUT TRANSISTOR	
FOR $T_A =$ FULL PACKAGE-TEMPERATURE RANGE (All Package Types)	100 mW
OPERATING-TEMPERATURE RANGE ( $T_A$ ):	
PACKAGE TYPES D, F, K, H	-55 to $+125^\circ\text{C}$
PACKAGE TYPE E	-40 to $+85^\circ\text{C}$
STORAGE TEMPERATURE RANGE ( $T_{STG}$ )	-65 to $+150^\circ\text{C}$
LEAD TEMPERATURE (DURING SOLDERING):	
At distance 1/16 $\pm$ 1/32 inch (1.59 $\pm$ 0.79 mm) from case for 10 s max.	$+265^\circ\text{C}$

RECOMMENDED OPERATING CONDITIONS at  $T_A = 25^\circ\text{C}$ , Except as Noted. For maximum reliability, nominal operating conditions should be selected so that operation is always within the following ranges:

CHARACTERISTIC	$V_{DD}$ (V)	LIMITS		UNITS
		Min.	Max.	
Supply-Voltage Range (For $T_A =$ Full Package-Temperature Range)		3	18	V
Clock Pulse Width, $t_{WCL}$	5	180	—	ns
	10	80	—	
	15	50	—	
Clock Rise and Fall Time, $t_{rCL}, t_{fCL}$	5	—	15	$\mu\text{s}$
	10	—	—	
	15	—	—	
Clock Input Frequency, $f_{CL}$	5	—	3	MHz
	10	DC	6	
	15	—	8.5	
Data Setup Time, $t_{SU}$	5	70	—	ns
	10	40	—	
	15	30	—	
Reset Pulse Width, $t_{WR}$	5	200	—	ns
	10	80	—	
	15	60	—	

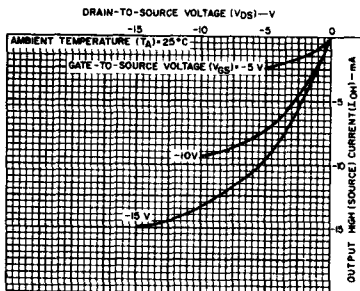

Fig. 5 - Minimum output high (source) current characteristics.

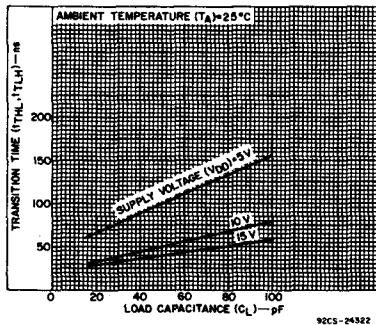

Fig. 6 - Typical transition time as a function of load capacitance.

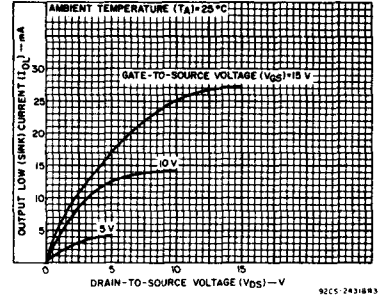

Fig. 2 - Typical output low (sink) current characteristics.

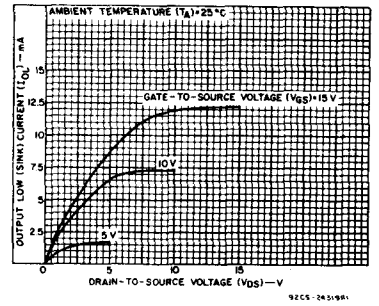

Fig. 3 - Minimum output low (sink) current characteristics.

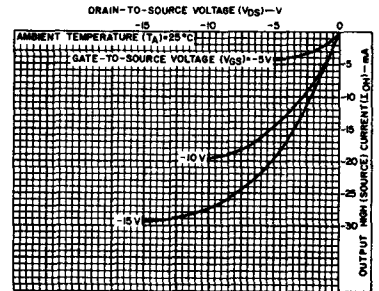

Fig. 4 - Typical output high (source) current characteristics.

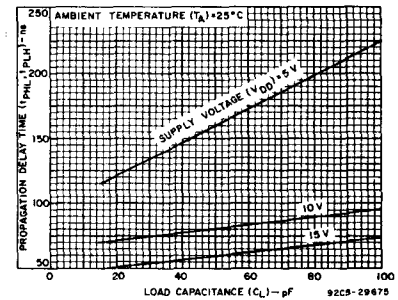
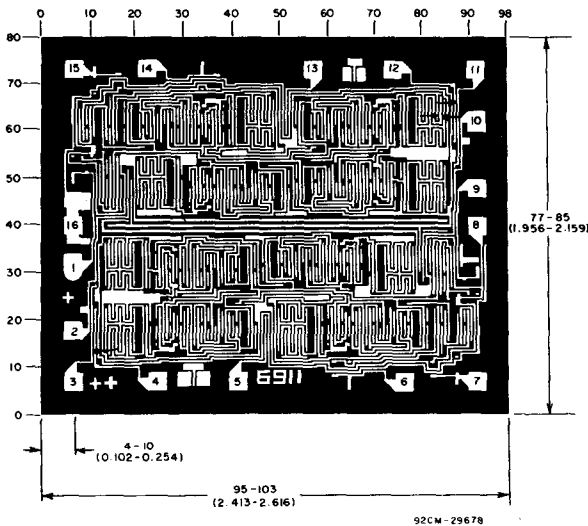

Fig. 7 - Typical propagation delay time as a function of load capacitance.

## STATIC ELECTRICAL CHARACTERISTICS

CHARACTERISTIC	CONDITIONS			LIMITS AT INDICATED TEMPERATURES (°C)						UNITS	
	V <sub>O</sub> (V)	V <sub>IN</sub> (V)	V <sub>DD</sub> (V)	+25							
				-55	-40	+85	+125	Min.	Typ.		Max.
Quiescent Device Current, I <sub>DD</sub> Max.	-	0,5	5	5	5	150	150	-	0,04	5	μA
	-	0,10	10	10	10	300	300	-	0,04	10	
	-	0,15	15	20	20	600	600	-	0,04	20	
	-	0,20	20	100	100	3000	3000	-	0,08	100	
Output Low (Sink) Current I <sub>OL</sub> Min.	0,4	0,5	5	0,64	0,61	0,42	0,36	0,51	1	-	mA
	0,5	0,10	10	1,6	1,5	1,1	0,9	1,3	2,6	-	
	1,5	0,15	15	4,2	4	2,8	2,4	3,4	6,8	-	
Output High (Source) Current, I <sub>OH</sub> Min.	4,6	0,5	5	-0,64	-0,61	-0,42	-0,36	-0,51	-1	-	mA
	2,5	0,5	5	-2	-1,8	-1,3	-1,15	-1,6	-3,2	-	
	9,5	0,10	10	-1,6	-1,5	-1,1	-0,9	-1,3	-2,6	-	
	13,5	0,15	15	-4,2	-4	-2,8	-2,4	-3,4	-6,8	-	
Output Voltage: Low-Level, V <sub>OL</sub> Max.	-	0,5	5	0,05			-	0	0,05	-	V
	-	0,10	10	0,05			-	0	0,05	-	
	-	0,15	15	0,05			-	0	0,05	-	
Output Voltage: High-Level, V <sub>OH</sub> Min.	-	0,5	5	4,95			-	4,95	5	-	V
	-	0,10	10	9,95			-	9,95	10	-	
	-	0,15	15	14,95			-	14,95	15	-	
Input Low Voltage, V <sub>IL</sub> Max.	0,5, 4,5	-	5	1,5			-	-	1,5	-	V
	1, 9	-	10	3			-	-	3	-	
	1,5, 13,5	-	15	4			-	-	4	-	
Input High Voltage, V <sub>IH</sub> Min.	0,5, 4,5	-	5	3,5			-	3,5	-	-	V
	1, 9	-	10	7			-	7	-	-	
	1,5, 13,5	-	15	11			-	11	-	-	
Input Current I <sub>IN</sub> Max.	-	0,18	18	±0,1	±0,1	±1	±1	-	±10 <sup>-5</sup>	±0,1	μA



Photograph of Chip Layout for CD4015B.

Dimensions in parentheses are in millimeters and are derived from the basic inch dimensions as indicated. Grid graduations are in mils (10<sup>-3</sup> inch).

The photographs and dimensions of each CMOS chip represent a chip when it is part of the wafer. When the wafer is separated into individual chips, the angle of cleavage may vary with respect to the chip face for different chips. The actual dimensions of the isolated chip, therefore, may differ slightly from the nominal dimensions shown. The user should consider a tolerance of -3 mils to +16 mils applicable to the nominal dimensions shown.

# CD4015B Types

DYNAMIC ELECTRICAL CHARACTERISTICS at  $T_A = 25^\circ\text{C}$ , Input  $t_r, t_f = 20\text{ ns}$ ,  $C_L = 50\text{ pF}$ ,  $R_L = 200\text{ k}\Omega$

CHARACTERISTIC	TEST CONDITIONS	LIMITS			UNITS	
		$V_{DD}(V)$	Min.	Typ.		Max.
<b>CLOCKED OPERATION</b>						
Propagation Delay Time; $T_{PHL}, T_{PLH}$		5	—	160	320	
		10	—	80	160	
		15	—	60	120	
Transition Time; $t_{THL}, t_{TLH}$		5	—	100	200	ns
		10	—	50	100	
		15	—	40	80	
Minimum Clock Pulse Width, $t_{WCL}$		5	—	90	180	
		10	—	40	80	
		15	—	25	50	
Clock Rise & Fall Time; $t_{rCL}, t_{fCL}^*$		5	—	—	15	$\mu\text{s}$
		10	—	—	15	
		15	—	—	15	
Minimum Data Setup Time, $t_{SU}$		5	—	35	70	ns
		10	—	20	40	
		15	—	15	30	
Maximum Clock Input Frequency, $f_{CL}$		5	3	6	—	MHz
		10	6	12	—	
		15	8.5	17	—	
Input Capacitance, $C_{IN}$	Any Input	—	5	7.5	$\text{pF}$	
<b>RESET OPERATION</b>						
Propagation Delay Time, $T_{PHL}$		5	—	200	400	ns
		10	—	100	200	
		15	—	80	160	
Minimum Reset Pulse Width $t_{WR}$		5	—	100	200	
		10	—	40	80	
		15	—	30	60	

\* If more than one unit is cascaded  $t_{rCL}$  should be made less than or equal to the sum of the transition time and the fixed propagation delay of the output of the driving stage for the estimated capacitive load.

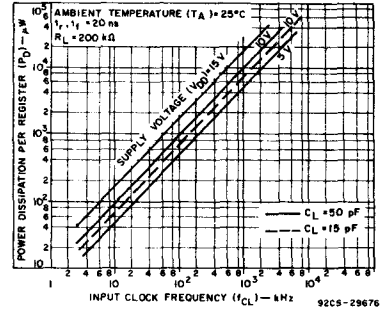

Fig. 8 — Typical power dissipation as a function of frequency.

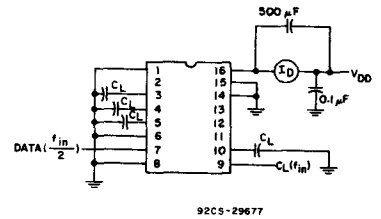

Fig. 9 — Power dissipation test circuit.

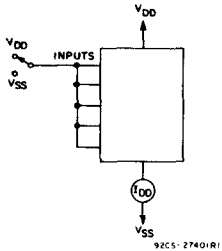

Fig. 10 — Quiescent device current test circuit.

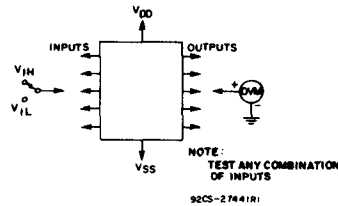

Fig. 11 — Input voltage test circuit.

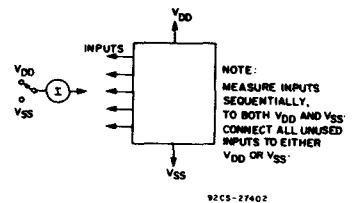

Fig. 12 — Input current test circuit.



# CMOS Quad Bilateral Switch

For Transmission or Multiplexing of Analog or Digital Signals

High-Voltage Types (20-Volt Rating)

The RCA-CD4016B Series types are quad bilateral switches intended for the transmission or multiplexing of analog or digital signals. Each of the four independent bilateral switches has a single control signal input which simultaneously biases both the p and n device in a given switch on or off.

The CD4016 "B" Series types are supplied in 14-lead hermetic dual-in-line ceramic packages (D and F suffixes), 14-lead dual-in-line plastic packages (E suffix), 14-lead ceramic flat packages (K suffix), and in chip form (H suffix).

**Features:**

- 20-V digital or  $\pm 10$ -V peak-to-peak switching
- 280- $\Omega$  typical on-state resistance for 15-V operation
- Switch on-state resistance matched to within 10  $\Omega$  typ. over 15-V signal-input range
- High on/off output-voltage ratio: 65 dB typ. @  $f_{is} = 10$  kHz,  $R_L = 10$  k $\Omega$
- High degree of linearity: <0.5% distortion typ. @  $f_{is} = 1$  kHz,  $V_{is} = 5$  V<sub>p-p</sub>,  $V_{DD}-V_{SS} \geq 10$  V,  $R_L = 10$  k $\Omega$
- Extremely low off-state switch leakage resulting in very low offset current and high effective off-state resistance: 100 pA typ. @  $V_{DD}-V_{SS}=18$  V,  $T_A=25^\circ\text{C}$
- Extremely high control input impedance (control circuit isolated from signal circuit: 10<sup>12</sup>  $\Omega$  typ.)
- Low crosstalk between switches: -50 dB typ. @  $f_{is} = 0.9$  MHz,  $R_L = 1$  k $\Omega$
- Matched control-input to signal-output capacitance: Reduces output signal transients
- Frequency response, switch on = 40 MHz (typ.)
- 100% tested for quiescent current at 20 V
- Maximum control input current of 1  $\mu\text{A}$  at 18 V over full package temperature range; 100 nA at 18 V at 25 $^\circ\text{C}$

**Applications:**

- Analog signal switching/multiplexing
  - Signal gating                      ■ Modulator
  - Squelch control                   ■ Demodulator
  - Chopper                             ■ Commutating switch
- Digital signal switching/multiplexing
- CMOS logic implementation
- Analog-to-digital & digital-to-analog conversion
- Digital control of frequency, impedance, phase, and analog-signal gain

**Terminal Assignment**

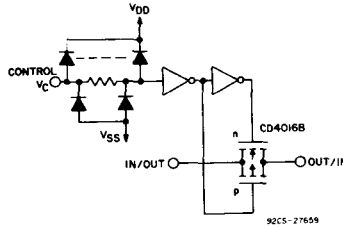
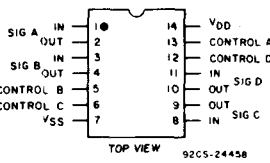

Schematic diagram - 1 of 4 identical sections.

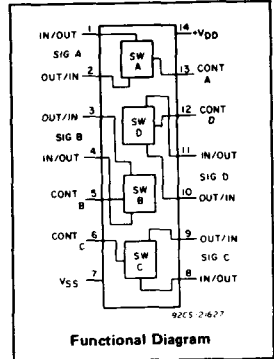

**RECOMMENDED OPERATING CONDITIONS**

For maximum reliability, nominal operating conditions should be selected so that operation is always within the following range:

CHARACTERISTIC	LIMITS		UNITS
	Min.	Max.	
Supply Voltage Range (For T <sub>A</sub> = Full Package Temperature Range)	3	18	V

**MAXIMUM RATINGS, Absolute-Maximum Values:**

- DC SUPPLY-VOLTAGE RANGE, (V<sub>DD</sub>) (Voltages referenced to V<sub>SS</sub> Terminal) - 0.5 to +20 V
- INPUT VOLTAGE RANGE, ALL INPUTS 0.5 to V<sub>DD</sub> + 0.5 V
- DC INPUT CURRENT, ANY ONE INPUT (INCLUDING TRANSMISSION GATE)  $\pm 10$  mA
- POWER DISSIPATION PER PACKAGE (P<sub>D</sub>) 500 mW
  - For T<sub>A</sub> = -40 to +60 $^\circ\text{C}$  (PACKAGE TYPE E)
  - For T<sub>A</sub> = +60 to +85 $^\circ\text{C}$  (PACKAGE TYPE E) Derate Linearly at 12 mW/ $^\circ\text{C}$  to 200 mW
  - For T<sub>A</sub> = -55 to +100 $^\circ\text{C}$  (PACKAGE TYPES D, F, K) 500 mW
  - For T<sub>A</sub> = +100 to +125 $^\circ\text{C}$  (PACKAGE TYPES D, F, K) Derate Linearly at 12 mW/ $^\circ\text{C}$  to 200 mW
- DEVICE DISSIPATION PER TRANSMISSION GATE 100 mW
- FOR T<sub>A</sub> = FULL PACKAGE-TEMPERATURE RANGE (All Package Types)
- OPERATING-TEMPERATURE RANGE (T<sub>A</sub>)
  - PACKAGE TYPES D, F, K, H -55 to +125 $^\circ\text{C}$
  - PACKAGE TYPE E -40 to +85 $^\circ\text{C}$
- STORAGE TEMPERATURE RANGE (T<sub>stg</sub>) -65 to +150 $^\circ\text{C}$
- LEAD TEMPERATURE (DURING SOLDERING): At distance 1/16  $\pm$  1/32 inch (1.59  $\pm$  0.79 mm) from case for 10 s max. +265 $^\circ\text{C}$

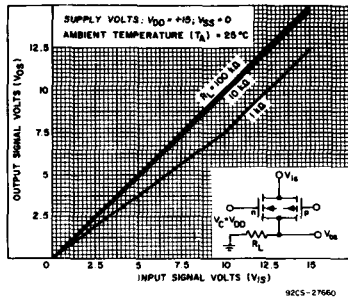

Fig. 1— Typ. on-state characteristics for 1 of 4 switches with V<sub>DD</sub> = +15 V, V<sub>SS</sub> = 0 V.

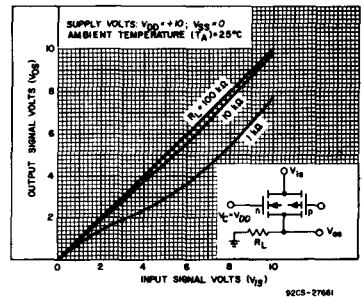

Fig. 2— Typ. on-state characteristics for 1 of 4 switches with V<sub>DD</sub> = +10 V, V<sub>SS</sub> = 0 V.

# CD4016B Types

## ELECTRICAL CHARACTERISTICS

Characteristic	Test Conditions	LIMITS AT INDICATED TEMPERATURE (°C)							UNITS	
		VIN (V)		VDD (V)		+25				
		-55	-40	+85	+125	Typ.	Max.			
Quiescent Device Current, $I_{DD}$		0.5	5	0.25	0.25	7.5	7.5	0.01	0.25	$\mu A$
		0.10	10	0.5	0.5	15	15	0.01	0.5	
		0.15	15	1	1	30	30	0.01	1	
		0.20	20	5	5	150	150	0.02	5	
Signal Inputs ( $V_{is}$ ) and Output ( $V_{os}$ )										
On-State Resistance, $r_{on}$ Max.	$V_C = V_{DD}$ $R_L = 10 k\Omega$ Returned to $V_{DD} - V_{SS}$ 2	$V_{is} = V_{DD}$ or $V_{SS}$	10	600	610	840	960	-	660	$\Omega$
		$V_{is} = 4.75$ to $5.75$ V	10	1870	1900	2380	2600	-	2000	
		$V_{is} = V_{DD}$ or $V_{SS}$	15	360	370	520	600	-	400	
		$V_{is} = 7.25$ to $7.75$ V	15	775	790	1080	1230	-	850	
$\Delta$ On-State Resistance Between Any 2 Switches, $\Delta r_{on}$	$R_L = 10 k\Omega$ , $V_C = V_{DD}$	5	-	-	-	-	15	-	$\Omega$	
		10	-	-	-	-	10	-		
		15	-	-	-	-	5	-		
Total Harmonic Distortion, THD	$V_C = V_{DD} = 5$ V, $V_{SS} = -5$ V, $V_{is}(p-p) = 5$ V (Sine wave centered on 0 V) $R_L = 10 k\Omega$ , $f_{is} = 1$ kHz sine wave		-	-	-	-	0.4	-	%	
-3dB Cutoff Frequency (Switch on)	$V_C = V_{DD} = 5$ V, $V_{SS} = -5$ V, $V_{is}(p-p) = 5$ V (Sine wave centered on 0 V) $R_L = 1 k\Omega$ ,		-	-	-	-	40	-	MHz	
-50dB Feed-through Frequency (Switch off)	$V_C = V_{SS} = -5$ V, $V_{is}(p-p) = 5$ V (Sine wave centered on 0 V) $R_L = 1 k\Omega$		-	-	-	-	1.25	-	MHz	
Input/Output Leakage Current (Switch off) $I_{is}$ Max.	$V_C = 0$ V $V_{is} = 18$ V, $V_{os} = 0$ V; $V_{is} = 0$ V, $V_{os} = 18$ V	18	$\pm 0.1$	$\pm 0.1$	$\pm 1$	$\pm 1$	$10^{-4}$	$\pm 0.1$	$\mu A$	
-50 dB Crosstalk Frequency	$V_C(A) = V_{DD} = +5$ V, $V_C(B) = V_{SS} = -5$ V, $V_{is}(A) = 5$ V p-p, 50 $\Omega$ source $R_L = 1 k\Omega$		-	-	-	-	0.9	-	MHz	
Propagation Delay (Signal Input to Signal Output) $t_{pd}$	$R_L = 200 k\Omega$ $V_C = V_{DD}$ , $V_{SS} = GND$ , $C_L = 50$ pF $V_{is} =$ Square Wave 0 to $V_{DD}$ $t_r, t_f = 20$ ns	5	-	-	-	-	40	100	ns	
		10	-	-	-	-	20	40		
		15	-	-	-	-	15	30		
Capacitance: Input, $C_{is}$ Output, $C_{os}$ Feedthrough, $C_{ios}$	$V_{DD} = +5$ V $V_C = V_{SS} = -5$ V		-	-	-	-	4	-	pF	
			-	-	-	-	4	-		
			-	-	-	-	0.2	-		

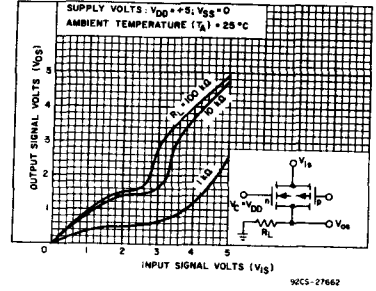

Fig. 3—Typ. on-state characteristics for 1 of 4 switches with  $V_{DD} = +5$  V,  $V_{SS} = 0$  V.

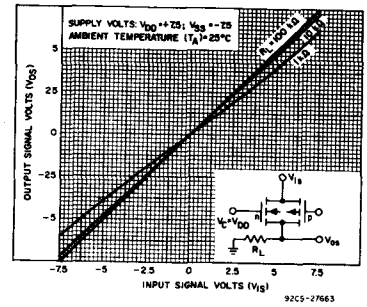

Fig. 4—Typ. on-state characteristics for 1 of 4 switches with  $V_{DD} = +7.5$  V,  $V_{SS} = -7.5$  V.

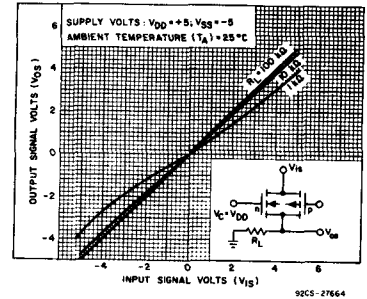

Fig. 5—Typ. on-state characteristics for 1 of 4 switches with  $V_{DD} = +5$  V,  $V_{SS} = -5$  V.

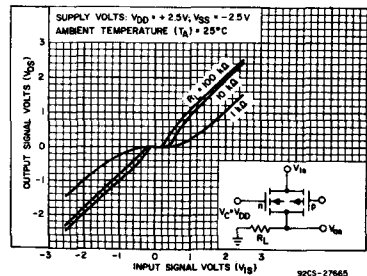

Fig. 6—Typ. on-state characteristics for 1 of 4 switches with  $V_{DD} = +2.5$  V,  $V_{SS} = -2.5$  V.

# CD4016B Types

## ELECTRICAL CHARACTERISTICS (cont'd)

Characteristic	Test Conditions	LIMITS AT INDICATED TEMPERATURE (°C)						UNITS	
		Values at -55, +25, +125 Apply to D, F, K, H Packages							
		Values at -40, +25, +85 Apply to E Package							
		V <sub>DD</sub> (V)					+25		
			-55	-40	+85	+125	Typ.	Max.	
<b>Control (V<sub>C</sub>)</b>									
Control Input Low Voltage, V <sub>ILC</sub> (Max.)	I <sub>is</sub>   < 10 μA V <sub>is</sub> = V <sub>SS</sub> , V <sub>OS</sub> = V <sub>DD</sub> and V <sub>is</sub> = V <sub>DD</sub> , V <sub>OS</sub> = V <sub>SS</sub>	5, 10, 15	0.9	0.9	0.4	0.4	-	0.7	V
Control Input High Voltage, V <sub>IHC</sub>	See Fig. 10	5, 10, 15	3.5 (Min.) 7 (Min.) 11 (Min.)						V
Input Current, I <sub>IN</sub> (Max.)	V <sub>is</sub> ≤ V <sub>DD</sub> V <sub>DD</sub> - V <sub>SS</sub> = 18 V V <sub>CC</sub> ≤ V <sub>DD</sub> - V <sub>SS</sub>	18	±0.1	±0.1	±1	±1	±10-5	±0.1	μA
Crosstalk (Control Input to Signal Output)	V <sub>C</sub> = 10 V (Sq. Wave) t <sub>r</sub> , t <sub>f</sub> = 20 ns R <sub>L</sub> = 10 kΩ	10	-	-	-	-	50	-	mV
Turn-On Propagation Delay	t <sub>r</sub> , t <sub>f</sub> = 20 ns C <sub>L</sub> = 50 pF R <sub>L</sub> = 1 kΩ	5, 10, 15	-	-	-	-	35, 20, 15	70, 40, 30	ns
Maximum Control Input Repetition Rate	V <sub>is</sub> = V <sub>DD</sub> , V <sub>SS</sub> = GND, R <sub>L</sub> = 1 kΩ to gnd, C <sub>L</sub> = 50 pF, V <sub>C</sub> = 10 V (Square wave centered on 5 V) t <sub>r</sub> , t <sub>f</sub> = 20 ns, V <sub>OS</sub> = ½ V <sub>OS</sub> @ 1 kHz	10	-	-	-	-	10	-	MHz
Input Capacitance, C <sub>IN</sub>			-	-	-	-	5	7.5	μF

V <sub>DD</sub> (V)	V <sub>is</sub> (V)	Switch Input I <sub>is</sub> (mA)						Switch Output V <sub>OS</sub> (V)	
		I <sub>is</sub> (mA)						Min.	Max.
		-55°C	-40°C	25°C*	25°C^A	+85°C	+125°C		
5	0	0.25	0.2	0.2	0.16	0.12	0.14	-	0.4
5	5	-0.25	-0.2	-0.2	-0.16	-0.12	-0.14	4.6	-
10	0	0.62	0.5	0.5	0.4	0.3	0.35	-	0.5
10	10	-0.62	-0.5	-0.5	-0.4	-0.3	-0.35	9.5	-
15	0	1.8	1.4	1.5	1.2	1	1.1	-	1.5
15	15	-1.8	-1.4	-1.5	-1.2	-1	-1.1	13.5	-

\* Plastic package

^ Ceramic package

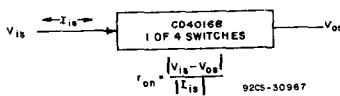

Fig. 10—Determination of  $r_{on}$  as a test condition for control input high voltage (V<sub>IHC</sub>) specification.

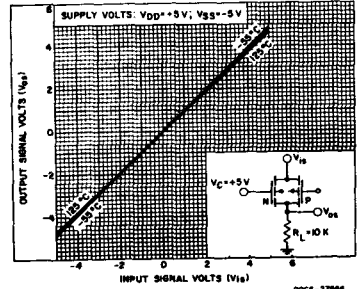

Fig. 7—Typ. on-state characteristics as a function of temp. for 1 of 4 switches with V<sub>DD</sub> = +5 V, V<sub>SS</sub> = -5 V.

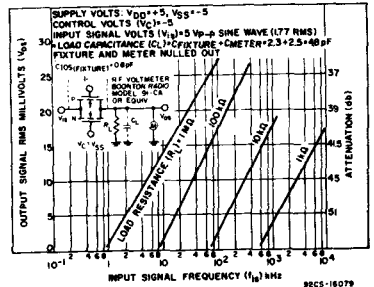

Fig. 8—Typ. feedthru vs. frequency—switch off.

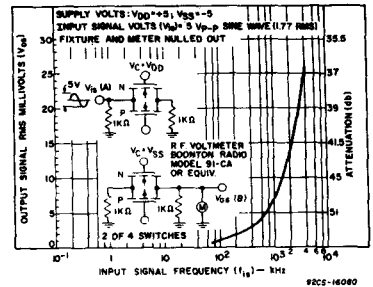

Fig. 9—Typical crosstalk between switch circuits in the same package.

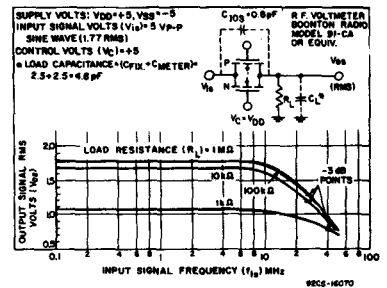

Fig. 11—Typical frequency response—switch on.

# CD4016B Types

## TYPICAL ON-STATE RESISTANCE CHARACTERISTICS, $T_A = 25^\circ\text{C}$

CHARACTERISTIC*	SUPPLY CONDITIONS		LOAD CONDITIONS					
			$R_L = 1\text{k}\Omega$		$R_L = 10\text{k}\Omega$		$R_L = 100\text{k}\Omega$	
			VALUE ( $\Omega$ )	$V_{IS}$ (V)	VALUE ( $\Omega$ )	$V_{IS}$ (V)	VALUE ( $\Omega$ )	$V_{IS}$ (V)
$r_{on}$	+15	0	200	+15	200	+15	180	+15
$r_{on}(\text{max.})$	+15	0	300	+11	300	+9.3	320	+9.2
$r_{on}$	+10	0	290	+10	250	+10	240	+10
$r_{on}(\text{max.})$	+10	0	290	0	250	0	300	0
$r_{on}$	+5	0	860	+5	470	+5	450	+5
$r_{on}(\text{max.})$	+5	0	600	0	580	0	800	0
$r_{on}$	+7.5	-7.5	200	+7.5	200	+7.5	180	+7.5
$r_{on}(\text{max.})$	+7.5	-7.5	200	-7.5	200	-7.5	180	-7.5
$r_{on}$	+5	-5	260	+5	250	+5	240	+5
$r_{on}(\text{max.})$	+5	-5	310	-5	250	-5	240	-5
$r_{on}$	+2.5	-2.5	590	+2.5	450	+2.5	490	+2.5
$r_{on}(\text{max.})$	+2.5	-2.5	720	-2.5	520	-2.5	520	-2.5
$r_{on}$	+2.5	-2.5	232k	+0.25	300k	+0.25	870k	+0.25

\* Variation from a perfect switch,  $r_{on} = 0 \Omega$ .

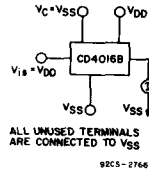

Fig. 12 - Off-state switch input or output leakage current test circuit.

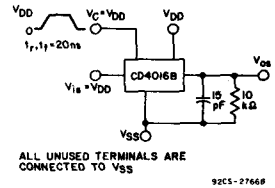
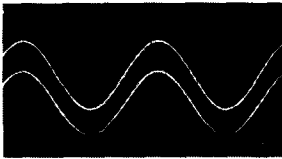

Fig. 13 - Test circuit for square-wave response.



SCALE: X = 0.2 ms/DIV Y = 2.0 V/DIV  
 $V_{DD} = V_C = +7.5\text{V}$ ,  $V_{SS} = -7.5\text{V}$ ,  $R_L = 10\text{k}\Omega$   
 $C_L = 15\text{pF}$   
 $f_{IS} = 1\text{KHz}$   $V_{IS} = 5\text{V p-p}$   
 DISTORTION = 0.2%

92CS-27612

Fig. 14 - Typical sine wave response of  $V_{DD} = +7.5\text{V}$ ,  $V_{SS} = -7.5\text{V}$ .

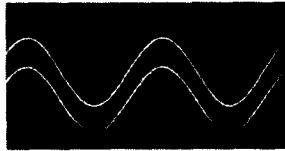

SCALE: X = 0.2 ms/DIV Y = 2.0 V/DIV  
 $V_{DD} = V_C = +5\text{V}$ ,  $V_{SS} = -5\text{V}$ ,  $R_L = 10\text{k}\Omega$   
 $C_L = 15\text{pF}$   
 $f_{IS} = 1\text{KHz}$   $V_{IS} = 5\text{V p-p}$   
 DISTORTION = 0.4%

92CS-27613

Fig. 15 - Typical sine wave response of  $V_{DD} = +5\text{V}$ ,  $V_{SS} = -5\text{V}$ .

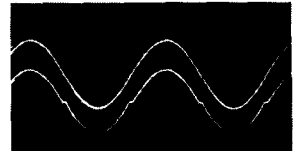

SCALE: X = 0.2 ms/DIV Y = 2.0 V/DIV  
 $V_{DD} = V_C = +2.5\text{V}$ ,  $V_{SS} = -2.5\text{V}$ ,  $R_L = 10\text{k}\Omega$   
 $C_L = 15\text{pF}$   
 $f_{IS} = 1\text{KHz}$   $V_{IS} = 5\text{V p-p}$   
 DISTORTION = 3%

92CS-27614

Fig. 16 - Typical sine wave response of  $V_{DD} = +2.5\text{V}$ ,  $V_{SS} = -2.5\text{V}$ .

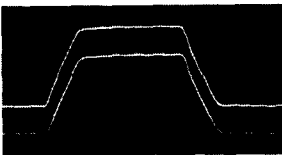

SCALE: X = 100 ns/DIV  
 Y = 5.0 V/DIV

92CS-27615

Fig. 17 - Typical square wave response at  $V_{DD} = V_C = +15\text{V}$ ,  $V_{SS} = \text{Gnd}$ .

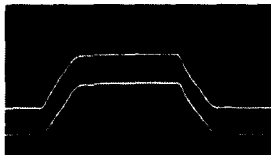

SCALE: X = 100 ns/DIV  
 Y = 5.0 V/DIV

92CS-27616

Fig. 18 - Typical square wave response at  $V_{DD} = V_C = +10\text{V}$ ,  $V_{SS} = \text{Gnd}$ .

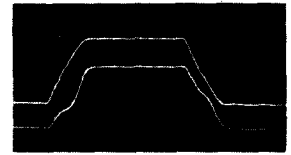

SCALE: X = 100 ns/DIV  
 Y = 2 V/DIV

92CS-27617

Fig. 19 - Typical square wave response at  $V_{DD} = V_C = +5\text{V}$ ,  $V_{SS} = \text{Gnd}$ .

# CD4016B Types

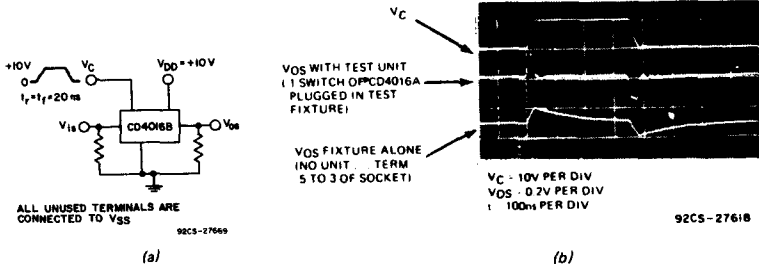

Fig.20 - Crosstalk-control input to signal output.

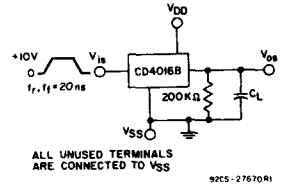

Fig.21 - Propagation delay time signal input ( $V_{IS}$ ) to signal output ( $V_{OS}$ ).

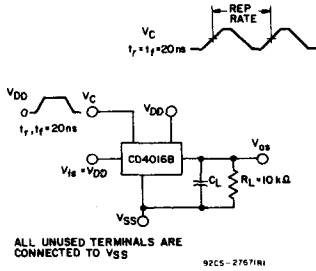

Fig. 22 - Max. control-input repetition rate.

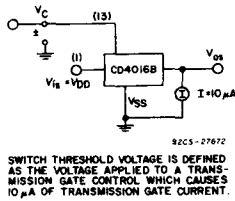

Fig.23 - Switch threshold voltage.

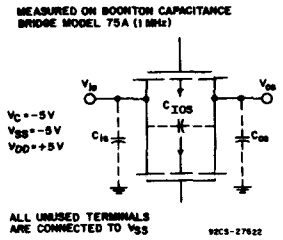

Fig.24 - Capacitance  $C_{IOS}$  and  $C_{OS}$ .

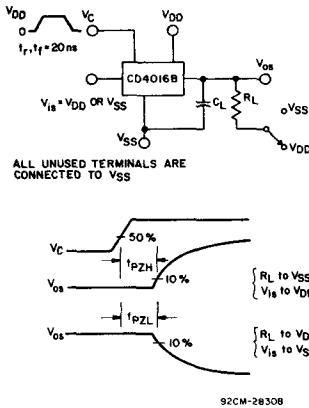
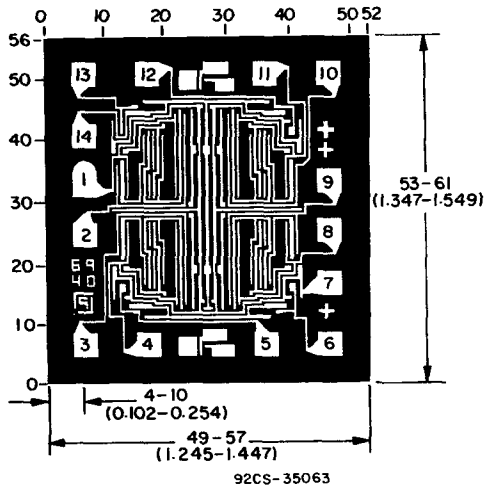

Fig.25 - Turn-On propagation delay-control input.

## Dimensions and pad layout for CD4016BH



Dimensions in parentheses are in millimeters and are derived from the basic inch dimensions as indicated. Grid graduations are in mils ( $10^{-3}$  inch).

The photographs and dimensions of each CMOS chip represent a chip when it is part of the wafer. When the wafer is separated into individual chips, the angle of cleavage may vary with respect to the chip face for different chips. The actual dimensions of the isolated chip, therefore, may differ slightly from the nominal dimensions shown. The user should consider a tolerance of  $-3$  mils to  $+16$  mils applicable to the nominal dimensions shown.

# CD4017B, CD4022B Types CMOS Counter/Dividers

High-Voltage Types (20-Volt Rating)

CD4017B—Decade Counter with  
10 Decoded Outputs

CD4022B—Octal Counter with  
8 Decoded Outputs

The RCA-CD4017B and CD4022B are 5-stage and 4-stage Johnson counters having 10 and 8 decoded outputs, respectively. Inputs include a CLOCK, a RESET, and a CLOCK INHIBIT signal. Schmitt trigger action in the CLOCK input circuit provides pulse shaping that allows unlimited clock input pulse rise and fall times.

These counters are advanced one count at the positive clock signal transition if the CLOCK INHIBIT signal is low. Counter advancement via the clock line is inhibited when the CLOCK INHIBIT signal is high. A high RESET signal clears the counter to its zero count. Use of the Johnson counter configuration permits high-speed operation, 2-input decode-gating and spike-free decoded outputs. Anti-lock gating is provided, thus assuring proper counting sequence. The decoded outputs are normally low and go high only at their respective decoded time slot. Each decoded output remains high for one full clock cycle. A CARRY-OUT signal completes one cycle every 10 clock input cycles in the CD4017B or every 8 clock input cycles in the CD4022B and is used to

### Features:

- Fully static operation
- Medium-speed operation . . . 10 MHz (typ.) at  $V_{DD} = 10\text{ V}$
- Standardized, symmetrical output characteristics
- 100% tested for quiescent current at 20 V
- 5-V, 10-V, and 15-V parametric ratings
- Meets all requirements of JEDEC Tentative Standard No. 13A, "Standard Specifications for Description of 'B' Series CMOS Devices"

### Applications:

- Decade counter/decimal decode display (CD4017B)
- Binary counter/decoder
- Frequency division
- Counter control/timers
- Divide-by-N counting
- For further application information, see ICAN-6166 "COS/MOS MSI Counter and Register Design and Applications"

ripple-clock the succeeding device in a multi-device counting chain.

The CD4017B and CD4022B-series types are supplied in 16-lead hermetic dual-in-line ceramic packages (D and F suffixes), 16-lead dual-in-line plastic package (E suffix), 16-lead ceramic flat packages (K suffix), and in chip form (H suffix).

### RECOMMENDED OPERATING CONDITIONS

For maximum reliability, nominal operating conditions should be selected so that operation is always within the following ranges:

CHARACTERISTICS	$V_{DD}$ (V)	LIMITS		UNITS
		Min.	Max.	
Supply-Voltage Range (For $T_A =$ Full Package-Temperature Range)		3	18	V
Clock Input Frequency, $f_{CL}$	5	—	2.5	MHz
	10	—	5	
	15	—	5.5	
Clock Pulse Width, $t_{PW}$	5	200	—	ns
	10	90	—	
	16	60	—	
Clock Rise & Fall Time, $t_{rCL}$ , $t_{fCL}$	5	UNLIMITED*		
	10			
	15			
Clock Inhibit Setup Time, $t_s$	5	230	—	ns
	10	100	—	
	15	70	—	
Reset Pulse Width, $t_{RW}$	5	260	—	ns
	10	110	—	
	15	60	—	
Reset Removal Time, $t_{rem}$	5	400	—	ns
	10	280	—	
	15	150	—	

\*Only if Pin 14 is used as the clock input. If Pin 13 is used as the clock input and Pin 14 is tied high (for advancing count on negative transition of the clock), rise and fall time should be  $\leq 15\ \mu\text{s}$ .

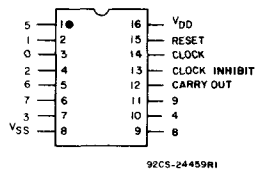
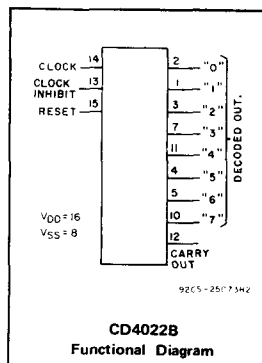
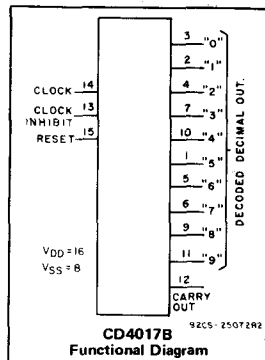

TOP VIEW  
CD4017B  
TERMINAL DIAGRAM

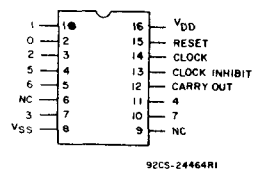

TOP VIEW  
CD4022B  
TERMINAL DIAGRAM

# CD4017B, CD4022B Types

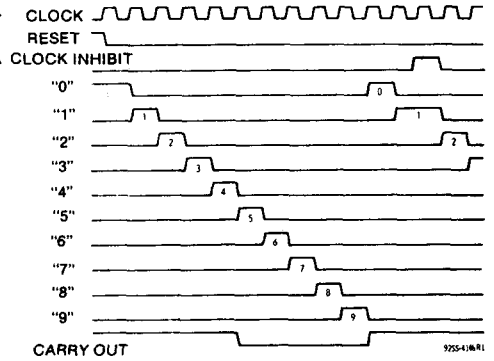
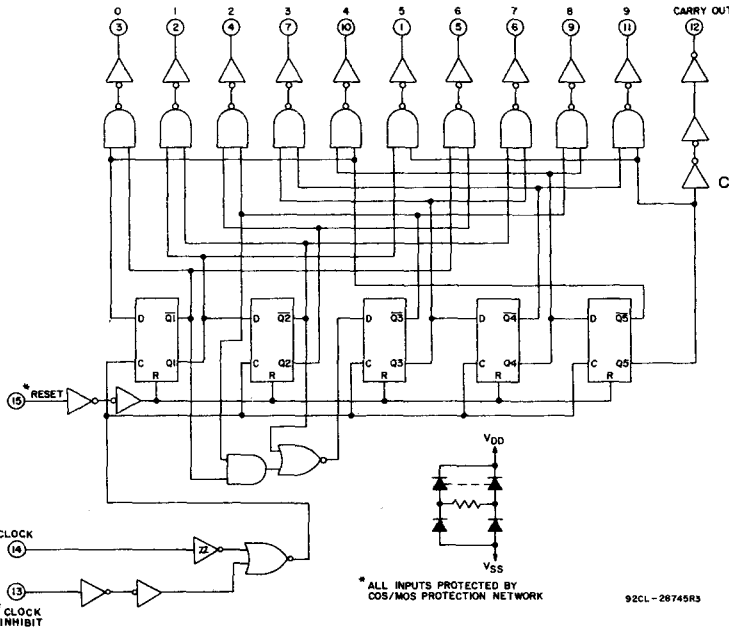

Fig. 2 - Timing diagram for CD4017B.

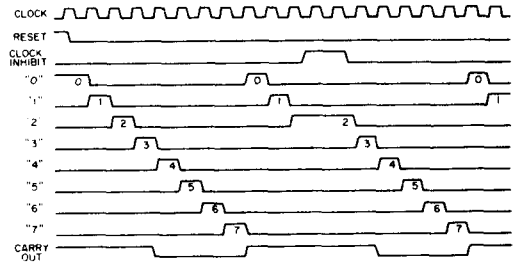
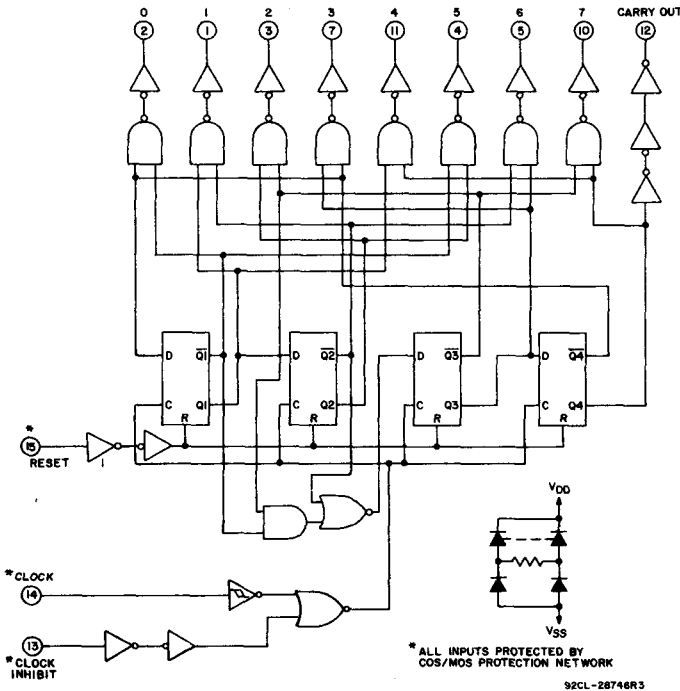

Fig. 4 - Timing diagram for CD4022B.

Fig. 3 - Logic diagram for CD4022B.

# CD4017B, CD4022B Types

## MAXIMUM RATINGS, Absolute-Maximum Values:

DC SUPPLY-VOLTAGE RANGE, (V <sub>DD</sub> ) (Voltages referenced to V <sub>SS</sub> Terminal)	-0.5 to +20 V
INPUT VOLTAGE RANGE, ALL INPUTS	-0.5 to V <sub>DD</sub> +0.5 V
DC INPUT CURRENT, ANY ONE INPUT	±10 mA
POWER DISSIPATION PER PACKAGE (P <sub>D</sub> ):	
For T <sub>A</sub> = -40 to +60°C (PACKAGE TYPE E)	500 mW
For T <sub>A</sub> = +60 to +85°C (PACKAGE TYPE E)	Derate Linearly at 12 mW/°C to 200 mW
For T <sub>A</sub> = -55 to +100°C (PACKAGE TYPES D, F, K)	500 mW
For T <sub>A</sub> = +100 to +125°C (PACKAGE TYPES D, F, K)	Derate Linearly at 12 mW/°C to 200 mW
DEVICE DISSIPATION PER OUTPUT TRANSISTOR:	
For T <sub>A</sub> = FULL PACKAGE-TEMPERATURE RANGE (All Package Types)	100 mW
OPERATING-TEMPERATURE RANGE (T <sub>A</sub> ):	
PACKAGE TYPES D, F, K, H	-55 to +125°C
PACKAGE TYPE E	-40 to +85°C
STORAGE TEMPERATURE RANGE (T <sub>stg</sub> )	-65 to +150°C
LEAD TEMPERATURE (DURING SOLDERING):	
At distance 1/16 ± 1/32 inch (1.59 ± 0.79 mm) from case for 10 s max.	+265°C

## STATIC ELECTRICAL CHARACTERISTICS

CHARACTERISTIC	CONDITIONS		LIMITS AT INDICATED TEMPERATURES (°C)								UNITS
	V <sub>O</sub> (V)	V <sub>IN</sub> (V)	V <sub>DD</sub> (V)	Values at -55, +25, +125 Apply to D, F, K, H, Packages				Values at -40, +25, +85 Apply to E Package			
				-55	-40	+85	+125	+25			
				Min.	Typ.	Max.	Min.	Typ.	Max.		
Quiescent Device Current, I <sub>DD</sub> Max.	-	0.5	5	5	5	150	150	-	0.04	5	μA
	-	0.10	10	10	10	300	300	-	0.04	10	
	-	0.15	15	20	20	600	600	-	0.04	20	
	-	0.20	20	100	100	3000	3000	-	0.08	100	
Output Low (Sink) Current I <sub>OL</sub> Min.	0.4	0.5	5	0.64	0.61	0.42	0.36	0.51	1	-	mA
	0.5	0.10	10	1.6	1.5	1.1	0.9	1.3	2.6	-	
	1.5	0.15	15	4.2	4	2.8	2.4	3.4	6.8	-	
Output High (Source) Current, I <sub>OH</sub> Min.	4.6	0.5	5	-0.64	-0.61	-0.42	-0.36	-0.51	-1	-	mA
	2.5	0.5	5	-2	-1.8	-1.3	-1.15	-1.6	-3.2	-	
	9.5	0.10	10	-1.6	-1.5	-1.1	-0.9	-1.3	-2.6	-	
	13.5	0.15	15	-4.2	-4	-2.8	-2.4	-3.4	-6.8	-	
Output Voltage: Low-Level, V <sub>OL</sub> Max.	-	0.5	5	0.05				-	0	0.05	V
	-	0.10	10	0.05				-	0	0.05	
	-	0.15	15	0.05				-	0	0.05	
Output Voltage: High-Level, V <sub>OH</sub> Min.	-	0.5	5	4.95				4.95	5	-	V
	-	0.10	10	9.95				9.95	10	-	
	-	0.15	15	14.95				14.95	15	-	
Input Low Voltage V <sub>IL</sub> Max.	0.5, 4.5	-	5	1.5				-	-	1.5	V
	1.9	-	10	3				-	-	3	
	1.5, 13.5	-	15	4				-	-	4	
Input High Voltage V <sub>IH</sub> Min.	0.5, 4.5	-	5	3.5				3.5	-	-	V
	1.9	-	10	7				7	-	-	
	1.5, 13.5	-	15	11				11	-	-	
Input Current I <sub>IN</sub> Max.	-	0.18	18	±0.1	±0.1	±1	±1	-	±10 <sup>-5</sup>	±0.1	μA

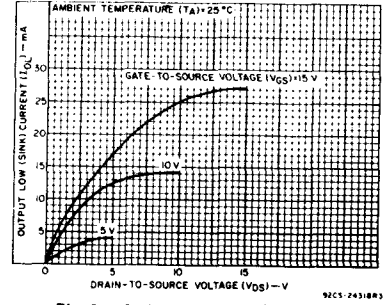

Fig. 5— Typical output low (sink) current characteristics.

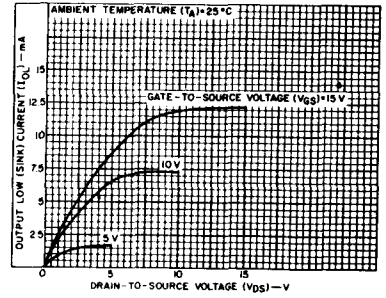

Fig. 6— Minimum output low (sink) current characteristics.

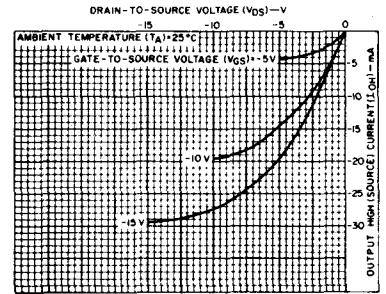

Fig. 7— Typical output high (source) current characteristics.

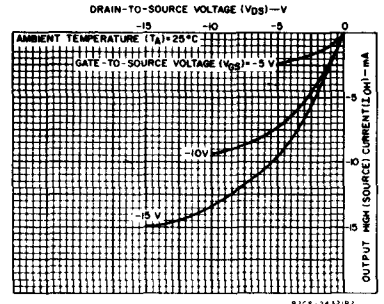

Fig. 8— Minimum output high (source) current characteristics.



# CD4017B, CD4022B Types

## DYNAMIC ELECTRICAL CHARACTERISTICS

At  $T_A = 25^\circ\text{C}$ , Input  $t_r, t_f = 20\text{ ns}$ ,  $C_L = 50\text{ pF}$ ,  $R_L = 200\text{ k}\Omega$

CHARACTERISTIC	CONDITIONS $V_{DD}$ (V)	LIMITS			UNITS
		Min.	Typ.	Max.	
<b>CLOCKED OPERATION</b>					
Propagation Delay Time, $t_{PHL}$ , $t_{PLH}$ Decode Out	5	—	325	650	ns
	10	—	135	270	
	15	—	85	170	
Carry Out	5	—	300	600	ns
	10	—	125	250	
	15	—	80	160	
Transition Time, $t_{THL}$ , $t_{TLH}$ Carry Out or Decode Out Line	5	—	100	200	ns
	10	—	50	100	
	15	—	40	80	
Maximum Clock Input Frequency, $f_{CL}^*$	5	2.5	5	—	MHz
	10	5	10	—	
	15	5.5	11	—	
Minimum Clock Pulse Width, $t_W$	5	—	100	200	ns
	10	—	45	90	
	15	—	30	60	
Clock Rise or Fall Time, $t_{rCL}$ , $t_{fCL}$	5, 10, 15	UNLIMITED			
Minimum Clock Inhibit to Clock Setup Time, $t_S$	5	—	115	230	ns
	10	—	50	100	
	15	—	35	70	
Input Capacitance, $C_{IN}$	Any Input	—	5	—	pF
<b>RESET OPERATION</b>					
Propagation Delay Time, $t_{PHL}$ , $t_{PLH}$ Carry Out or Decode Out Lines	5	—	265	530	ns
	10	—	115	230	
	15	—	85	170	
Minimum Reset Pulse Width, $t_W$	5	—	130	260	ns
	10	—	55	110	
	15	—	30	60	
Minimum Reset Removal Time	5	—	200	400	ns
	10	—	140	280	
	15	—	75	150	

\* Measured with respect to carry output line.

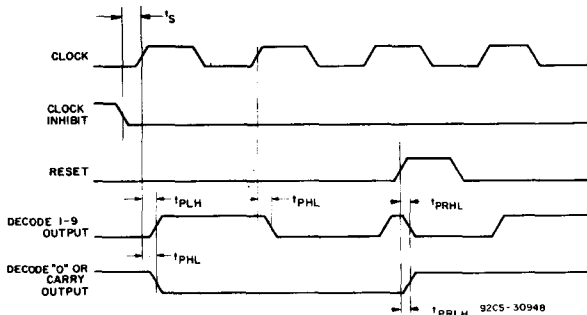

DELAYS MEASURED BETWEEN 50% LEVELS ON ALL WAVEFORMS

Fig. 9— Propagation delay, setup, and hold time waveforms.

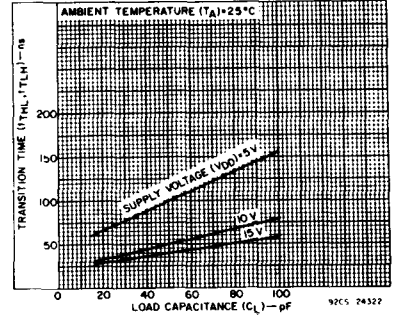

Fig. 10 — Typical transition time as a function of load capacitance.

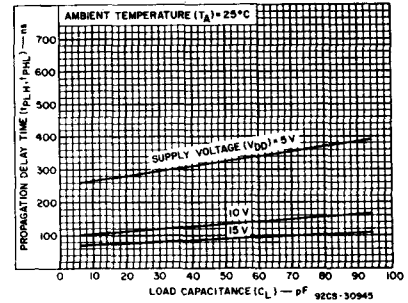

Fig. 11 — Typical propagation delay time as a function of load capacitance (clock to decode output).

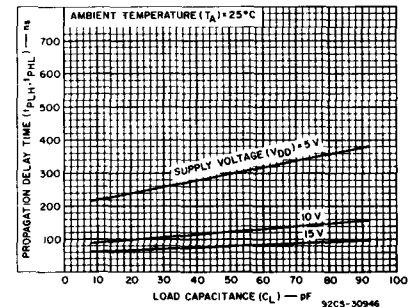

Fig. 12 — Typical propagation delay time as a function of load capacitance (clock to carry-out).

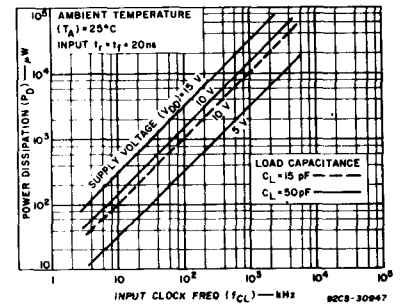

Fig. 13 — Typical dynamic power dissipation as a function of clock input frequency.

# CD4017B, CD4022B Types

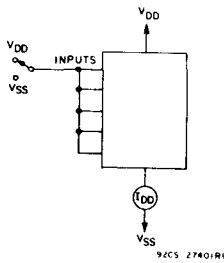

Fig. 14 - Quiescent device-current test circuit.

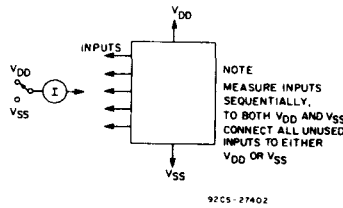

Fig. 15 - Input-leakage current.

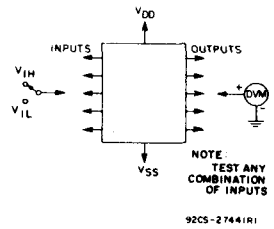

Fig. 16 - Input-voltage test circuit.

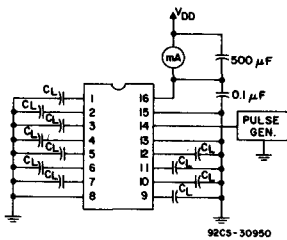

Fig. 17 - Dynamic power dissipation test circuit.

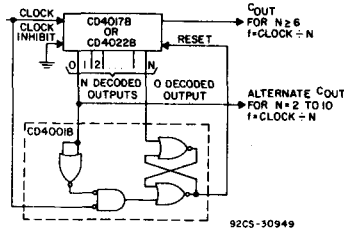
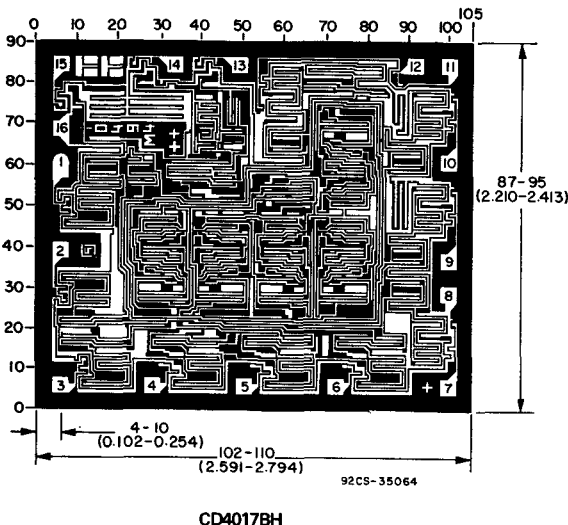
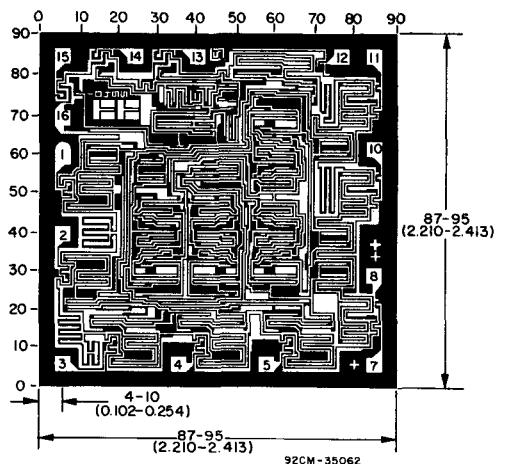

Fig. 18 - Divide by  $N$  counter ( $N \leq 10$ ) with  $N$  decoded outputs.

When the  $N^{\text{th}}$  decoded output is reached ( $N^{\text{th}}$  clock pulse) the S-R flip flop (constructed from two NOR gates of the CD4001B) generates a reset pulse which clears the CD4017B or CD4022B to its zero count. At this time, if the  $N^{\text{th}}$  decoded output is greater than or equal to 6 in the CD4017B or 5 in the CD4022B, the  $C_{\text{OUT}}$  line goes high to clock the next CD4017B or CD4022B counter section. The "0" decoded output also goes high at this time. Coincidence of the clock low and decoded "0" output low resets the S-R flip flop to enable the CD4017B or CD4022B counter section. The "0" decoded output is less than 6 (CD4017B) or 5 (CD4022B), the  $C_{\text{OUT}}$  line will not go high and, therefore, cannot be used. In this case "0" decoded output may be used to perform the clocking function for the next counter.



CD4017BH



CD4022BH

The photographs and dimensions of each CMOS chip represent a chip when it is part of the wafer. When the wafer is separated into individual chips, the angle of cleavage may vary with respect to the chip face for different chips. The actual dimensions of the isolated chip, therefore, may differ slightly from the nominal dimensions shown. The user should consider a tolerance of  $-3$  mils to  $+16$  mils applicable to the nominal dimensions shown.

Dimensions in parentheses are in millimeters and are derived from the basic inch dimensions as indicated. Grid graduations are in mils ( $10^{-3}$  inch).

# CD4018B Types

## CMOS Presettable Divide-By-'N' Counter

### High-Voltage Types (20-Volt Rating)

The RCA-CD4018B types consist of 5 Johnson-Counter stages, buffered Q outputs from each stage, and counter preset control gating. CLOCK, RESET, DATA, PRESET ENABLE, and 5 individual JAM inputs are provided. Divide by 10, 8, 6, 4, or 2 counter configurations can be implemented by feeding the  $\bar{Q}_5$ ,  $\bar{Q}_4$ ,  $\bar{Q}_3$ ,  $\bar{Q}_2$ ,  $\bar{Q}_1$  signals, respectively, back to the DATA input. Divide-by-9, 7, 5, or 3 counter configurations can be implemented by the use of a CD4011B to gate the feedback connection to the DATA input. Divide-by functions greater than 10 can be achieved by use of multiple CD4018B units. The counter is advanced one count at the positive clock-signal transition. Schmitt Trigger action on the clock line permits unlimited clock rise and fall times. A high RESET signal clears the counter to an all-zero condition. A high PRESET-ENABLE signal allows information on the JAM inputs to preset the counter. Anti-lock gating is provided to assure the proper counting sequence.

The CD4018B types are supplied in 16-lead hermetic dual-in-line ceramic packages (D and F suffixes), 16-lead dual-in-line plastic packages (E suffix), 16-lead ceramic flat packages (K suffix), and in chip form (H suffix).

### Features:

- Medium speed operation . . . . . 10 MHz (typ.) at  $V_{DD} - V_{SS} = 10\text{ V}$
- Fully static operation
- 100% tested for quiescent current at 20 V
- Standardized, symmetrical output characteristics
- 5-V, 10-V, and 15-V parametric ratings
- Maximum input current of  $1\ \mu\text{A}$  at 18 V over full package-temperature range; 100 nA at 18 V and  $25^\circ\text{C}$
- Noise margin (full package-temperature range) =  $1\text{ V}$  at  $V_{DD} = 5\text{ V}$   
 $2\text{ V}$  at  $V_{DD} = 10\text{ V}$   
 $2.5\text{ V}$  at  $V_{DD} = 15\text{ V}$
- Meets all requirements of JEDEC Tentative Standard No. 13A, "Standard Specifications for Description of 'B' Series CMOS Devices"

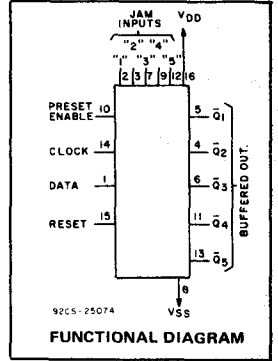

### Applications:

- Fixed and programmable divide-by-10, 9, 8, 7, 6, 5, 4, 3, 2 counters
- Fixed and programmable counters greater than 10
- Programmable decade counters
- Divide-by-"N" counters/frequency synthesizers
- Frequency division
- Counter control/timers

TERMINAL DIAGRAM  
Top View

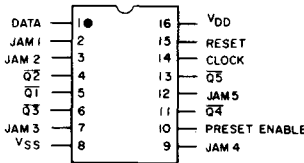

92CS-24460

### MAXIMUM RATINGS, Absolute-Maximum Values:

DC SUPPLY-VOLTAGE RANGE, ( $V_{DD}$ ) (Voltages referenced to $V_{SS}$ Terminal)	-0.5 to +20 V
INPUT VOLTAGE RANGE, ALL INPUTS	-0.5 to $V_{DD} + 0.5\text{ V}$
DC INPUT CURRENT, ANY ONE INPUT	$\pm 10\text{ mA}$
POWER DISSIPATION PER PACKAGE ( $P_D$ ):	
For $T_A = -40$ to $+60^\circ\text{C}$ (PACKAGE TYPE E)	500 mW
For $T_A = +60$ to $+85^\circ\text{C}$ (PACKAGE TYPE E)	Derate Linearly at $12\text{ mW}/^\circ\text{C}$ to 200 mW
For $T_A = -55$ to $+100^\circ\text{C}$ (PACKAGE TYPES D, F, K)	500 mW
For $T_A = +100$ to $+125^\circ\text{C}$ (PACKAGE TYPES D, F, K)	Derate Linearly at $12\text{ mW}/^\circ\text{C}$ to 200 mW
DEVICE DISSIPATION PER OUTPUT TRANSISTOR FOR $T_A = \text{FULL PACKAGE-TEMPERATURE RANGE (All Package Types)}$	100 mW
OPERATING-TEMPERATURE RANGE ( $T_A$ ):	
PACKAGE TYPES D, F, K, H	$-55$ to $+125^\circ\text{C}$
PACKAGE TYPE E	$-40$ to $+85^\circ\text{C}$
STORAGE TEMPERATURE RANGE ( $T_{stg}$ )	$-65$ to $+150^\circ\text{C}$
LEAD TEMPERATURE (DURING SOLDERING):	
At distance $1/16 \pm 1/32$ inch ( $1.59 \pm 0.79\text{ mm}$ ) from case for 10 s max.	$+265^\circ\text{C}$

# CD4018B Types

**RECOMMENDED OPERATING CONDITIONS at  $T_A = 25^\circ\text{C}$ , Unless Otherwise Specified**  
 For maximum reliability, nominal operating conditions should be selected so that operation is always within the following ranges.

CHARACTERISTIC	VDD	Min.	Max.	UNITS
Supply Voltage Range (at $T_A = \text{Full Package-Temperature Range}$ )		3	18	V
Clock Input Frequency, $f_{CL}$	5	—	3	MHz
	10	—	7	
	15	—	8.5	
Clock Pulse Width, $t_W$	5	160	—	ns
	10	70	—	
	15	50	—	
Clock Rise & Fall Time, $t_{r,CL}, t_{f,CL}$	5	Unlimited		$\mu\text{s}$
	10			
	15			
Data Input Set-Up Time, $t_S$	5	40	—	ns
	10	12	—	
	15	16	—	
Data Input Hold Time, $t_H$	5	140	—	ns
	10	80	—	
	15	60	—	
Preset or Reset Pulse Width, $t_W$	5	160	—	ns
	10	70	—	
	15	50	—	
Preset or Reset Removal Time	5	80	—	ns
	10	30	—	
	15	20	—	

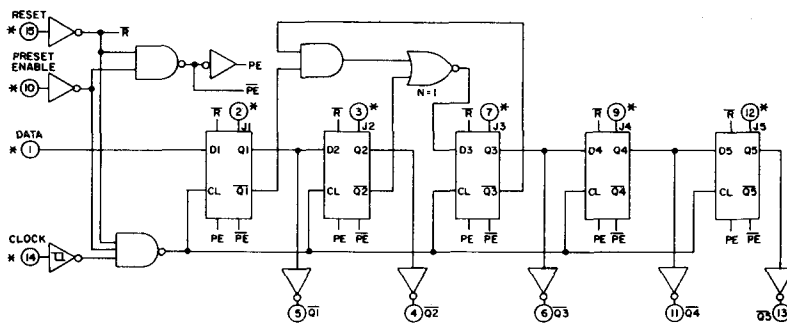

Fig. 1 - Logic diagram.

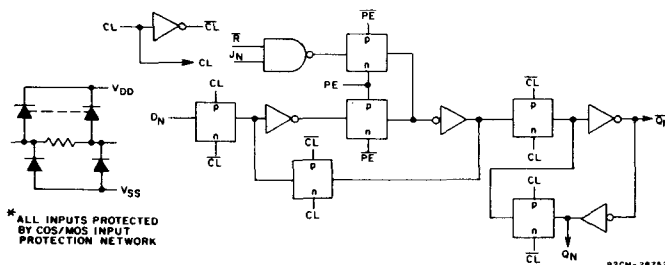

Fig. 2 - Detail of a typical stage.

# CD4018B Types

## STATIC ELECTRICAL CHARACTERISTICS

CHARACTERISTIC	CONDITIONS			LIMITS AT INDICATED TEMPERATURES (°C)							UNITS
				Values at -55, +25, +125 Apply to D, F, K, H Packages Values at -40, +25, +85 Apply to E Package							
	V <sub>O</sub> (V)	V <sub>IN</sub> (V)	V <sub>DD</sub> (V)	-55	-40	+85	+125	+25			
								Min.	Typ.	Max.	
Quiescent Device Current, I <sub>DD</sub> Max.	-	0,5	5	5	5	150	150	-	0.04	5	μA
	-	0,10	10	10	10	300	300	-	0.04	10	
	-	0,15	15	20	20	600	600	-	0.04	20	
	-	0,20	20	100	100	3000	3000	-	0.08	100	
Output Low (Sink) Current, I <sub>OL</sub> Min.	0.4	0,5	5	0.64	0.61	0.42	0.36	0.51	1	-	mA
	0.5	0,10	10	1.6	1.5	1.1	0.9	1.3	2.6	-	
	1.5	0,15	15	4.2	4	2.8	2.4	3.4	6.8	-	
Output High (Source) Current, I <sub>OH</sub> Min.	4.6	0,5	5	-0.64	-0.61	-0.42	-0.36	-0.51	-1	-	mA
	2.5	0,5	5	-2	-1.8	-1.3	-1.15	-1.6	-3.2	-	
	9.5	0,10	10	-1.6	-1.5	-1.1	-0.9	-1.3	-2.6	-	
	13.5	0,15	15	-4.2	-4	-2.8	-2.4	-3.4	-6.8	-	
Output Voltage: Low-Level, V <sub>OL</sub> Max.	-	0,5	5	0.05			-	0	0.05	-	V
	-	0,10	10	0.05			-	0	0.05	-	
	-	0,15	15	0.05			-	0	0.05	-	
Output Voltage: High-Level, V <sub>OH</sub> Min.	-	0,5	5	4.95			4.95	5	-	-	V
	-	0,10	10	9.95			9.95	10	-	-	
	-	0,15	15	14.95			14.95	15	-	-	
Input Low Voltage, V <sub>IL</sub> Max.	0.5,4.5	-	5	1.5			-	-	1.5	-	V
	1.9	-	10	3			-	-	3	-	
	1.5,13.5	-	15	4			-	-	4	-	
Input High Voltage, V <sub>IH</sub> Min.	0.5,4.5	-	5	3.5			3.5	-	-	-	V
	1.9	-	10	7			7	-	-	-	
	1.5,13.5	-	15	11			11	-	-	-	
Input Current I <sub>IN</sub> Max.	-	0,18	18	±0.1	±0.1	±1	±1	-	±10 <sup>-5</sup>	±0.1	μA

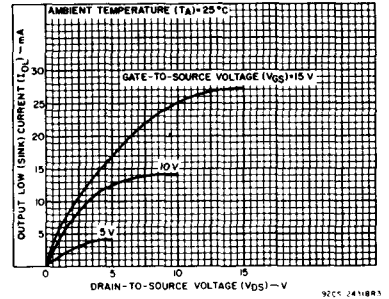

Fig. 3 - Typical output low (sink) current characteristics.

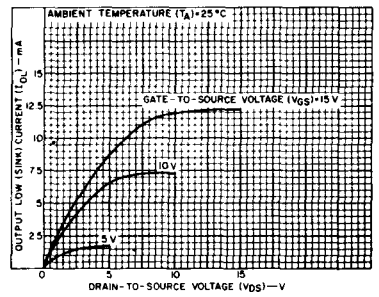

Fig. 4 - Minimum output low (sink) current characteristics.

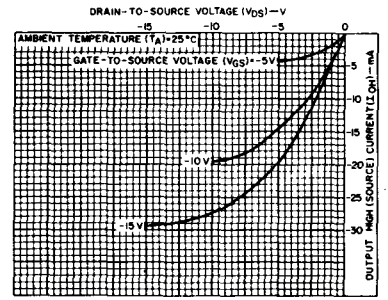

Fig. 5 - Typical output high (source) current characteristics.

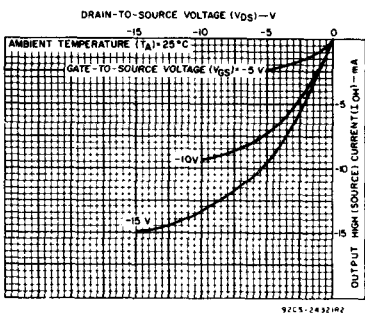

Fig. 6 - Minimum output high (source) current characteristics.

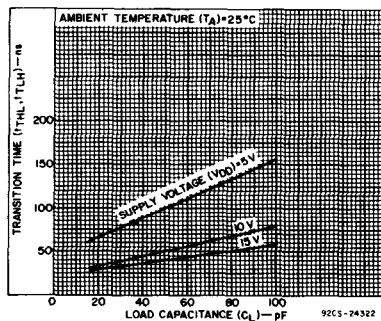

Fig. 7 - Typical transition time as a function of load capacitance.

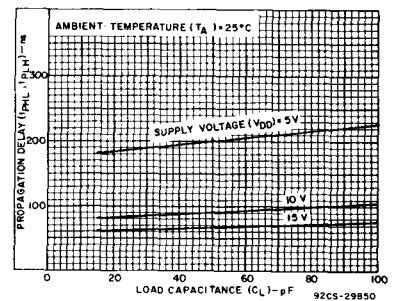

Fig. 8 - Typical propagation delay time as a function of load capacitance (CLOCK to Q).

# CD4018B Types

DYNAMIC ELECTRICAL CHARACTERISTICS at  $T_A = 25^\circ\text{C}$ , Input  $t_r, t_f = 20\text{ ns}$ ,  $C_L = 50\text{ pF}$ ,  $R_L = 200\text{ k}\Omega$

CHARACTERISTIC	TEST CONDITIONS	LIMITS			UNITS	
		V <sub>DD</sub> (V)	Min.	Typ.		Max.
<b>CLOCKED OPERATION</b>						
Propagation Delay Time; $t_{PLH}, t_{PHL}$		5	—	200	400	ns
		10	—	90	180	
		15	—	65	130	
Transition Time; $t_{THL}, t_{TLH}$		5	—	100	200	ns
		10	—	50	100	
		15	—	40	80	
Maximum Clock Input Frequency, $f_{CL}$		5	3	6	—	MHz
		10	7	14	—	
		15	8.5	17	—	
Minimum Clock Pulse Width, $t_W$		5	—	80	160	ns
		10	—	35	70	
		15	—	25	50	
Clock Rise & Fall Time; $t_{rCL}, t_{fCL}$		5	Unlimited		$\mu\text{s}$	
		10	Unlimited			
		15	Unlimited			
Minimum Data Input Set-Up Time, $t_S$		5	—	20	40	ns
		10	—	6	12	
		15	—	3	6	
Minimum Data Input Hold Time, $t_H$		5	—	70	140	ns
		10	—	40	80	
		15	—	30	60	
Average Input Capacitance, $C_I$	Any Input	—	5	7.5	pF	
<b>PRESET* OR RESET OPERATION</b>						
Propagation Delay Time; Preset or Reset to $\bar{Q}$ $t_{PLH}, t_{PHL}$		5	—	275	550	ns
		10	—	125	250	
		15	—	90	180	
Minimum Preset or Reset Pulse Width, $t_W$		5	—	80	160	ns
		10	—	35	70	
		15	—	25	50	
Minimum Preset or Reset Removal Time		5	—	40	80	ns
		10	—	15	30	
		15	—	10	20	

\* At PRESET ENABLE or JAM Inputs.

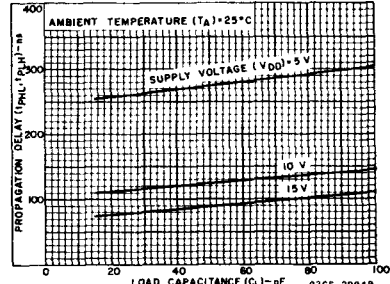

Fig. 9 - Typical propagation delay time as a function of load capacitance (RESET to Q).

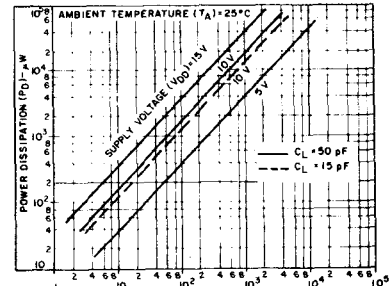

Fig. 10 - Typical dynamic power dissipation as a function of clock input frequency.

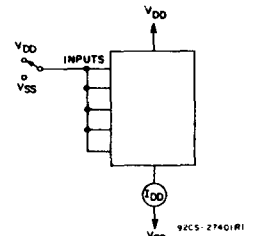

Fig. 11 - Quiescent device current test circuit.

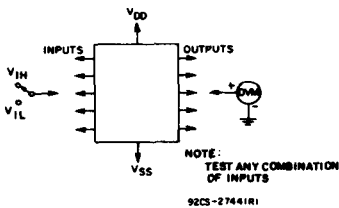

Fig. 12 - Input voltage test circuit.

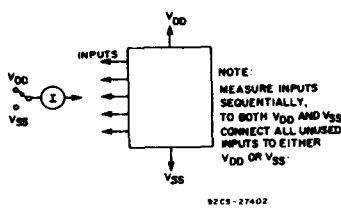

Fig. 13 - Input current test circuit.

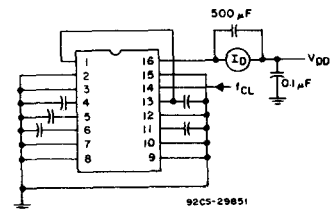

Fig. 14 - Dynamic power dissipation test circuit.

# CD4018B Types

("DATA" INPUT TIED TO  $\bar{Q}_5$  FOR DECADE COUNTER CONFIGURATION)

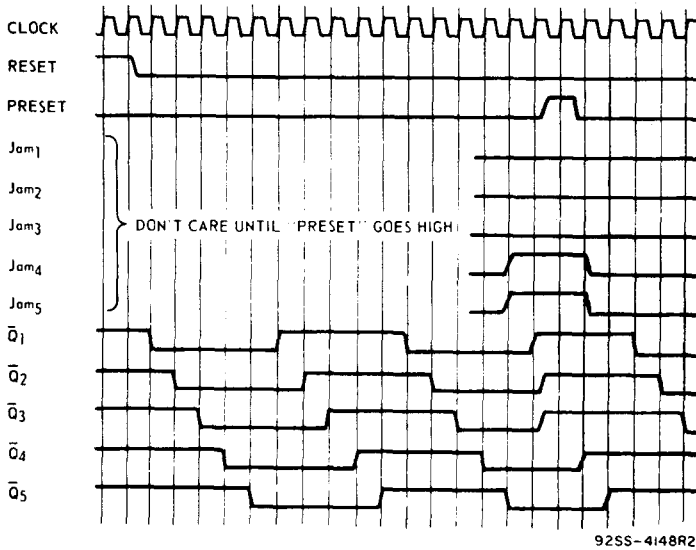

Fig. 15 -- Timing diagram.

92SS-4148R2

## EXTERNAL CONNECTIONS FOR DIVIDE BY 10, 9, 8, 7, 6, 5, 4, 3 OPERATION

DIVIDE BY 10  $\bar{Q}_5$   
 DIVIDE BY 8  $\bar{Q}_4$   
 DIVIDE BY 6  $\bar{Q}_3$   
 DIVIDE BY 4  $\bar{Q}_2$   
 DIVIDE BY 2  $\bar{Q}_1$

CONNECTED BACK TO "DATA" } NO EXTERNAL COMPONENTS REQUIRED

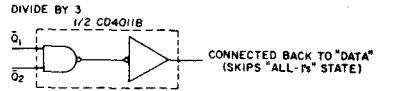
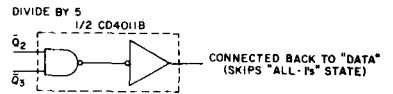
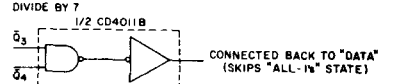
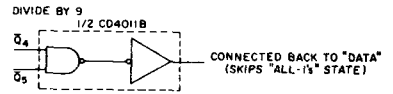

92CS-17071R3

Fig. 16 -- External connections for divide by 10, 9, 8, 7, 5, 4, 3, 2 operation.

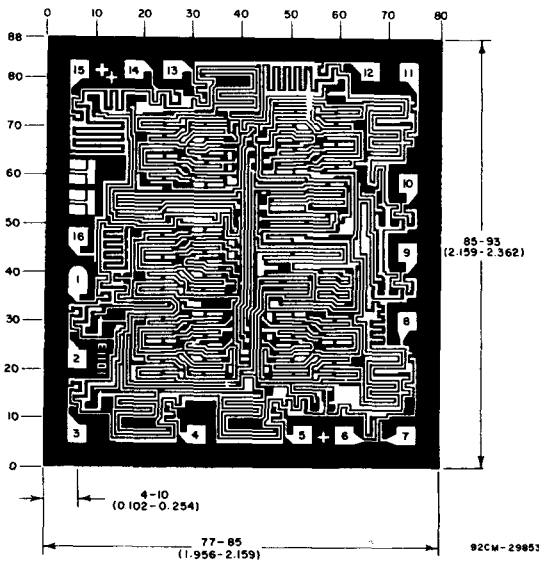

Dimensions and pad layout for CD4018B.

Dimensions in parentheses are in millimeters and are derived from the basic inch dimensions as indicated. Grid graduations are in mils ( $10^{-3}$  inch).

The photographs and dimensions of each CMOS chip represent a chip when it is part of the wafer. When the wafer is separated into individual chips, the angle of cleavage may vary with respect to the chip face for different chips. The actual dimensions of the isolated chip, therefore, may differ slightly from the nominal dimensions shown. The user should consider a tolerance of  $-3$  mils to  $+16$  mils applicable to the nominal dimensions shown.

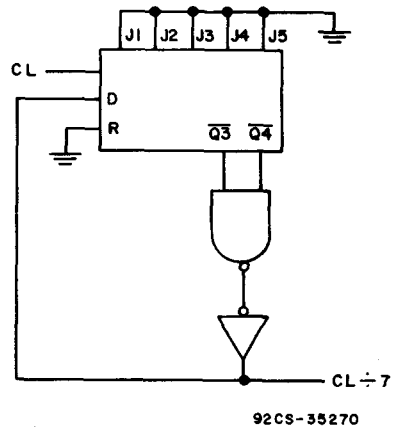

Fig. 17 -- Example of divide by 7.

# CD4019B Types

## CMOS Quad AND/OR Select Gate

High-Voltage Types (20-Volt Rating)

The RCA-CD4019B types consist of four AND/OR select gate configurations, each consisting of two 2-input AND gates driving a single 2-input OR gate. Selection is accomplished by control bits  $K_A$  and  $K_B$ . In addition to selection of either channel A or channel B information, the control bits can be applied simultaneously to accomplish the logical  $A + B$  function.

The CD4019B types are supplied in 16-lead hermetic dual-in-line ceramic packages (D and F suffixes), 16-lead dual-in-line plastic packages (E suffix), 16-lead ceramic flat packages (K suffix), and in chip form (H suffix).

### Features:

- Medium-speed operation . . . . .  
 . . .  $t_{PHL} = t_{PLH} = 60$  ns (typ.) at  $C_L = 50$  pF,  $V_{DD} = 10$  V
- Standardized, symmetrical output characteristics
- 100% tested for quiescent current at 20 V
- 5-V, 10-V, and 15-V parametric ratings
- Meets all requirements of JEDEC Tentative Standard No. 13A, "Standard Specifications for Description of 'B' Series CMOS Devices"
- Maximum input current of  $1 \mu A$  at 18 V over full package-temperature range; 100 nA at 18 V and 25°C
- Noise margin (full package-temperature range) =  $1$  V at  $V_{DD} = 5$  V  
 $2$  V at  $V_{DD} = 10$  V  
 $2.5$  V at  $V_{DD} = 15$  V

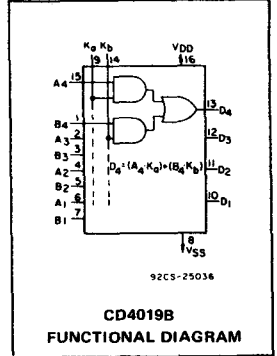

### Applications:

- AND-OR select gating
- Shift-right/shift-left registers
- True/complement selection
- AND/OR/Exclusive-OR selection

### MAXIMUM RATINGS, Absolute-Maximum Values:

DC SUPPLY-VOLTAGE RANGE, ( $V_{DD}$ ) (Voltages referenced to $V_{SS}$ Terminal)	-0.5 to +20 V
INPUT VOLTAGE RANGE, ALL INPUTS	-0.5 to $V_{DD} + 0.5$ V
DC INPUT CURRENT, ANY ONE INPUT	$\pm 10$ mA
POWER DISSIPATION PER PACKAGE ( $P_D$ ):	
For $T_A = -40$ to $+60^\circ C$ (PACKAGE TYPE E)	500 mW
For $T_A = +60$ to $+85^\circ C$ (PACKAGE TYPE E)	Derate Linearly at 12 mW/ $^\circ C$ to 200 mW
For $T_A = -55$ to $+100^\circ C$ (PACKAGE TYPES D, F, K)	500 mW
For $T_A = +100$ to $+125^\circ C$ (PACKAGE TYPES D, F, K)	Derate Linearly at 12 mW/ $^\circ C$ to 200 mW
DEVICE DISSIPATION PER OUTPUT TRANSISTOR:	
For $T_A =$ FULL PACKAGE-TEMPERATURE RANGE (All Package Types)	100 mW
OPERATING-TEMPERATURE RANGE ( $T_A$ ):	
PACKAGE TYPES D, F, K, H	-55 to $+125^\circ C$
PACKAGE TYPE E	-40 to $+85^\circ C$
STORAGE TEMPERATURE RANGE ( $T_{stg}$ )	-65 to $+150^\circ C$
LEAD TEMPERATURE (DURING SOLDERING):	
At distance 1/16 $\pm$ 1/32 inch (1.59 $\pm$ 0.79 mm) from case for 10 s max.	$+265^\circ C$

### TERMINAL DIAGRAM

Top View

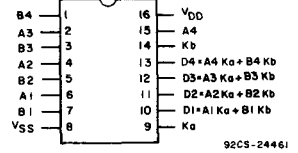

### TRUTH TABLE

$K_A$	$K_B$	$A_n$	$B_n$	$D_n$
1	0	1	X	1
1	0	0	X	0
0	1	X	1	1
0	1	X	0	0
0	0	X	X	0
1	1	0	0	0
1	1	0	1	1
1	1	1	0	1
1	1	1	1	1

X = Don't Care

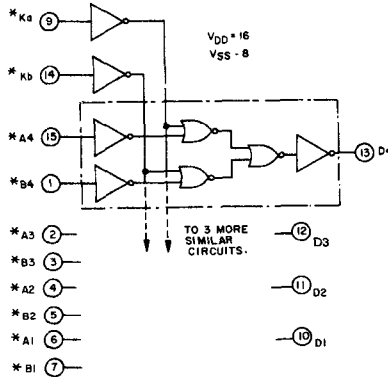
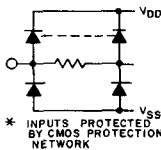

Fig. 1—Logic diagram.

### RECOMMENDED OPERATING CONDITIONS

For maximum reliability, nominal operating conditions should be selected so that operation is always within the following ranges:

CHARACTERISTIC	$V_{DD}$ (V)	Min.	Max.	Units
Supply-Voltage Range (For $T_A =$ Full Package Temperature Range)	-	3	18	V



# CD4019B Types

## STATIC ELECTRICAL CHARACTERISTICS

CHARACTERISTIC	CONDITIONS			LIMITS AT INDICATED TEMPERATURES (°C)							UNITS
	V <sub>O</sub> (V)	V <sub>IN</sub> (V)	V <sub>DD</sub> (V)	Values at -55, +25, +125 Apply to D, F, K, H Packages				+25			
				-55	-40	+85	+125	Min.	Typ.	Max.	
Quiescent Device Current, I <sub>DD</sub> Max.	-	0.5	5	1	1	30	30	-	0.02	1	μA
	-	0.10	10	2	2	60	60	-	0.02	2	
	-	0.15	15	4	4	120	120	-	0.02	4	
	-	0.20	20	20	20	600	600	-	0.04	20	
Output Low (Sink) Current I <sub>OL</sub> Min.	0.4	0.5	5	0.64	0.61	0.42	0.36	0.51	1	-	mA
	0.5	0.10	10	1.6	1.5	1.1	0.9	1.3	2.6	-	
	1.5	0.15	15	4.2	4	2.8	2.4	3.4	6.8	-	
Output High (Source) Current, I <sub>OH</sub> Min.	4.6	0.5	5	-0.64	-0.61	-0.42	-0.36	-0.51	-1	-	mA
	2.5	0.5	5	-2	-1.8	-1.3	-1.15	-1.6	-3.2	-	
	9.5	0.10	10	-1.6	-1.5	-1.1	-0.9	-1.3	-2.6	-	
	13.5	0.15	15	-4.2	-4	-2.8	-2.4	-3.4	-6.8	-	
Output Voltage: Low-Level, V <sub>OL</sub> Max.	-	0.5	5	0.05				-	0	0.05	V
	-	0.10	10	0.05				-	0	0.05	
	-	0.15	15	0.05				-	0	0.05	
Output Voltage: High-Level, V <sub>OH</sub> Min.	-	0.5	5	4.95				4.95	5	-	V
	-	0.10	10	9.95				9.95	10	-	
	-	0.15	15	14.95				14.95	15	-	
Input Low Voltage, V <sub>IL</sub> Max.	0.5, 4.5	-	5	1.5				-	-	1.5	V
	1.9	-	10	3				-	-	3	
	1.5, 13.5	-	15	4				-	-	4	
Input High Voltage, V <sub>IH</sub> Min.	0.5, 4.5	-	5	3.5				3.5	-	-	V
	1.9	-	10	7				7	-	-	
	1.5, 13.5	-	15	11				11	-	-	
Input Current I <sub>IN</sub> Max.	-	0.18	18	±0.1	±0.1	±1	±1	-	±10 <sup>-5</sup>	±0.1	μA

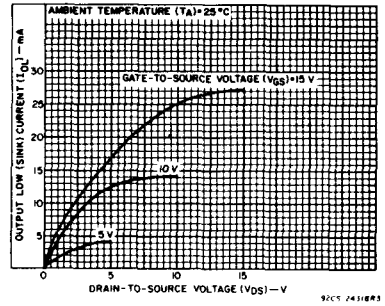

Fig. 2 - Typical output low (sink) current characteristics.

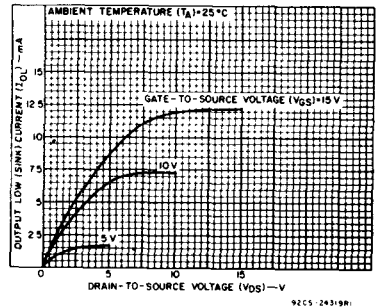

Fig. 3 - Minimum output low (sink) current characteristics.

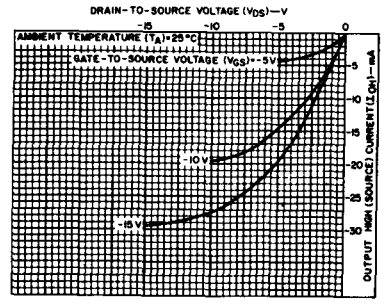

Fig. 4 - Typical output high (source) current characteristics.

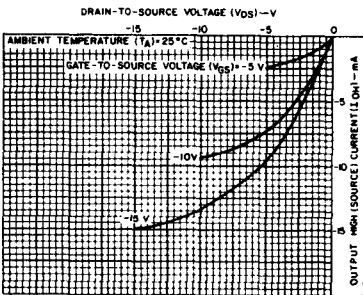

Fig. 5 - Minimum output high (source) current characteristics.

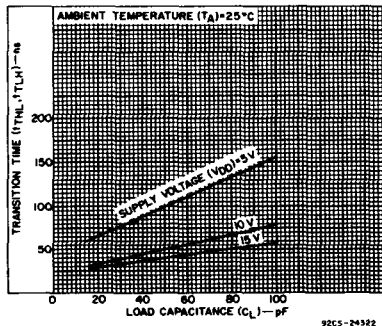

Fig. 6 - Typical transition time as a function of load capacitance.

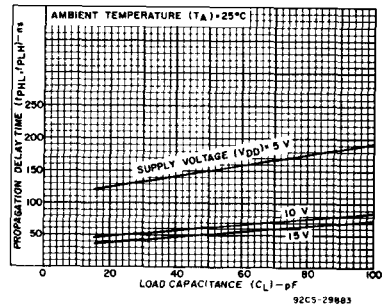

Fig. 7 - Propagation delay time as a function of load capacitance.

# CD4019B Types

DYNAMIC ELECTRICAL CHARACTERISTICS at  $T_A = 25^\circ\text{C}$ , Input  $t_r, t_f = 20 \text{ ns}$ ,  $C_L = 50 \text{ pF}$ ,  $R_L = 200 \text{ k}\Omega$

CHARACTERISTIC	TEST CONDITIONS	LIMITS			UNITS	
		VDD (V)	Min.	Typ.		Max.
Propagation Delay Time; $t_{PLH}, t_{PHL}$		5	—	150	300	ns
		10	—	60	120	
		15	—	50	100	
Transition Time; $t_{THL}, t_{TLH}$		5	—	100	200	ns
		10	—	50	100	
		15	—	40	80	
Input Capacitance, $C_{IN}$	All A and B Inputs	—	5	7.5	pF	
	$K_a$ and $K_b$ Inputs	—	10	15	pF	

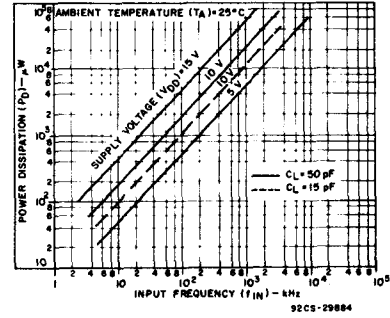

Fig. 8 — Typical dynamic power dissipation as a function of input frequency.

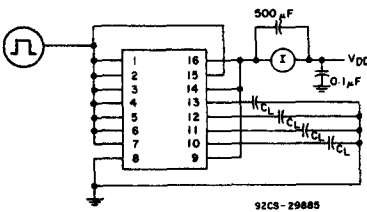

Fig. 9 — Dynamic power dissipation test circuit.

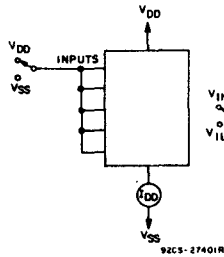

Fig. 10 — Quiescent device current test circuit.

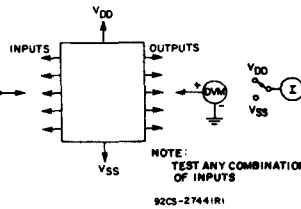

Fig. 11 — Input voltage test circuit.

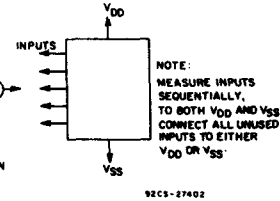

Fig. 12 — Input current test circuit.

## TYPICAL APPLICATIONS

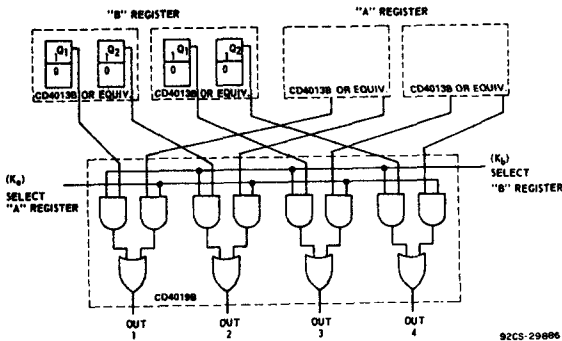

Fig. 13 — AND/OR select gating.

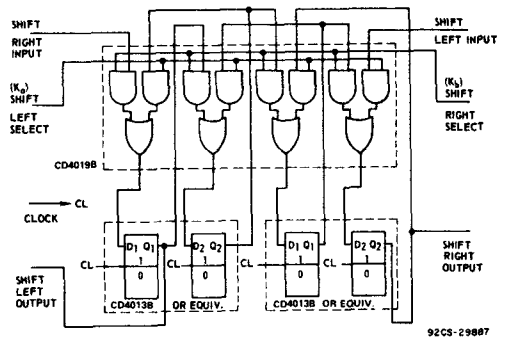

Fig. 14 — "Shift left/shift right" register.

## TYPICAL APPLICATIONS (CONT'D)

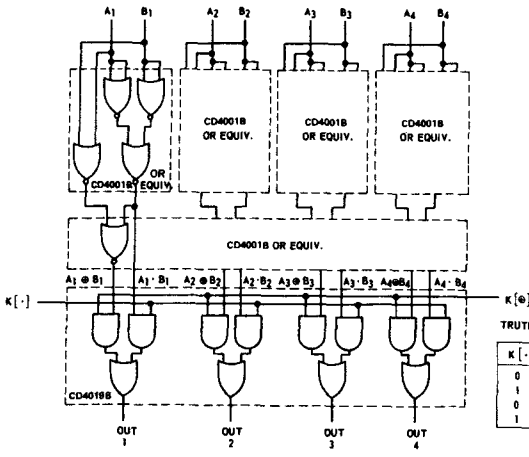

Fig. 15 - AND/OR Exclusive-OR selector.

TRUTH TABLE

K [-]	K [⊕]	OUT
0	0	0
1	0	A·B
0	1	A⊕B
1	1	A·B

92CS-29888

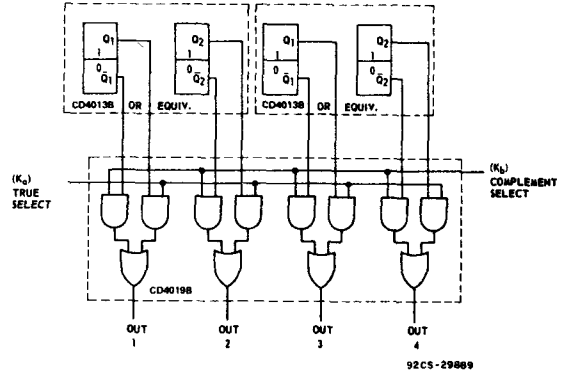
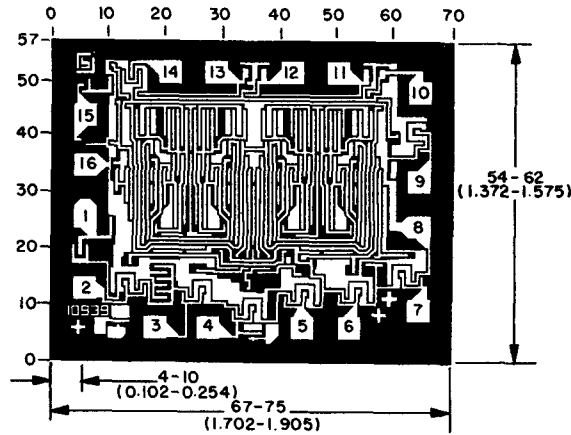

Fig. 16 - "True complement" selector.



92CS-36092

### Dimensions and pad layout for CD4019BH

Dimensions in parentheses are in millimeters and are derived from the basic inch dimensions as indicated. Grid graduations are in mils ( $10^{-3}$  inch).

The photographs and dimensions of each CMOS chip represent a chip when it is part of the wafer. When the wafer is separated into individual chips, the angle of cleavage may vary with respect to the chip face for different chips. The actual dimensions of the isolated chip, therefore, may differ slightly from the nominal dimensions shown. The user should consider a tolerance of  $-3$  mils to  $+16$  mils applicable to the nominal dimensions shown.

# CD4020B, CD4024B, CD4040B Types

## CMOS Ripple-Carry Binary Counter/Dividers

High-Voltage Types (20-Volt Rating)

CD4020B — 14 Stage

CD4024B — 7 Stage

CD4040B — 12 Stage

RCA-CD4020B, CD4024B, and CD4040B are ripple-carry binary counters. All counter stages are master-slave flip-flops. The state of a counter advances one count on the negative transition of each input pulse; a high level on the RESET line resets the counter to its all zeros state. Schmitt trigger action on the input-pulse line permits unlimited rise and fall times. All inputs and outputs are buffered.

The CD4020B and CD4040B types are supplied in 16-lead hermetic dual-in-line ceramic packages (D and F suffixes), 16-lead dual-in-line plastic packages (E suffix), 16-lead ceramic flat packages (K suffix), and in chip form (H suffix).

The CD4024B types are supplied in 14-lead hermetic dual-in-line ceramic packages (D and F suffixes), 14-lead dual-in-line plastic packages (E suffix), 14-lead ceramic flat packages (K suffix), and in chip form (H suffix).

### MAXIMUM RATINGS, Absolute-Maximum Values:

DC SUPPLY-VOLTAGE RANGE, (V <sub>DD</sub> ) (Voltages referenced to V <sub>SS</sub> Terminal)	-0.5 to +20 V
INPUT VOLTAGE RANGE, ALL INPUTS	-0.5 to V <sub>DD</sub> +0.5 V
DC INPUT CURRENT, ANY ONE INPUT	±10 mA
POWER DISSIPATION PER PACKAGE (P <sub>D</sub> ):	
For T <sub>A</sub> = -40 to +60°C (PACKAGE TYPE E)	500 mW
For T <sub>A</sub> = +60 to +85°C (PACKAGE TYPE E)	Derate Linearly at 12 mW/°C to 200 mW
For T <sub>A</sub> = -55 to +100°C (PACKAGE TYPES D, F, K)	500 mW
For T <sub>A</sub> = +100 to +125°C (PACKAGE TYPES D, F, K)	Derate Linearly at 12 mW/°C to 200 mW
DEVICE DISSIPATION PER OUTPUT TRANSISTOR FOR T <sub>A</sub> = FULL PACKAGE-TEMPERATURE RANGE (All Package Types)	100 mW
OPERATING-TEMPERATURE RANGE (T <sub>A</sub> ):	
PACKAGE TYPES D, F, K, H	-55 to +125°C
PACKAGE TYPE E	-40 to +85°C
STORAGE TEMPERATURE RANGE (T <sub>stg</sub> )	-65 to +150°C
LEAD TEMPERATURE (DURING SOLDERING):	
At distance 1/16 ± 1/32 inch (1.59 ± 0.79 mm) from case for 10 s max.	+265°C

### TERMINAL ASSIGNMENTS

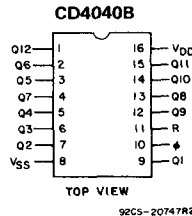
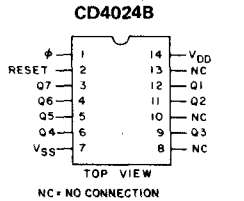
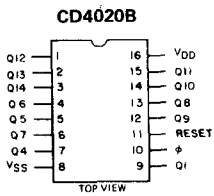

### Features:

- Medium-speed operation
- Fully static operation
- Buffered inputs and outputs
- 100% tested for quiescent current at 20 V
- Standardized, symmetrical output characteristics
- Fully static operation
- Common reset
- 5-V, 10-V, and 15-V parametric ratings
- Maximum input current of 1 μA at 18 V over full package-temperature range; 100 nA at 18 V and 25°C
- Noise margin (over full package-temperature range):  
1 V at V<sub>DD</sub> = 5 V  
2 V at V<sub>DD</sub> = 10 V  
2.5 V at V<sub>DD</sub> = 15 V

- Meets all requirements of JEDEC Tentative Standard No. 13A, "Standard Specifications for Description of 'B' Series CMOS Devices"

### Applications:

- Control counters
- Timers
- Frequency dividers
- Time-delay circuits

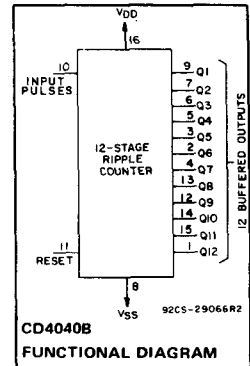
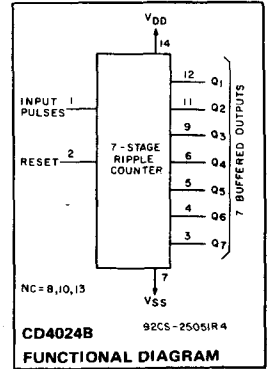
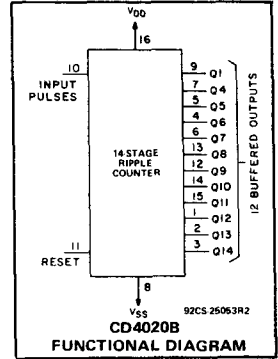

# CD4020B, CD4024B, CD4040B Types

**RECOMMENDED OPERATING CONDITIONS at  $T_A = 25^\circ\text{C}$ , Unless Otherwise Specified**  
 For maximum reliability, nominal operating conditions should be selected so that operation is always within the following ranges:

CHARACTERISTIC		$V_{DD}$	Min.	Max.	UNITS
Supply Voltage Range (at $T_A = \text{Full Package-Temperature Range}$ )			3	18	V
Input-Pulse Frequency,	$f_\phi$	5 10 15	—	3.5 8 12	MHz
Input-Pulse Width,	$t_W$	5 10 15	140 60 40	— — —	ns
Input-Pulse Rise or Fall Time,	$t_{r\phi}, t_{f\phi}$	5 10 15	Unlimited		$\mu\text{s}$
Reset Pulse Width,	$t_W$	5 10 15	200 80 60	— — —	ns
Reset Removal Time,	$t_{REM}$	5 10 15	350 150 100	— — —	ns

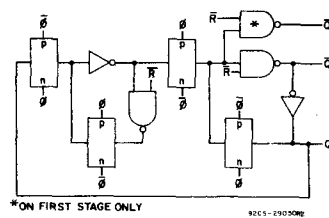

Fig. 4 - Detail of typical flip-flop stage.

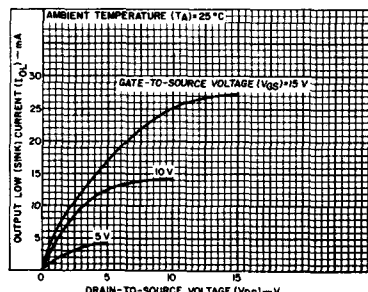

Fig. 5 - Typical output low (sink) current characteristics.

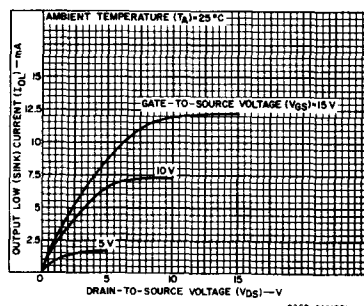

Fig. 6 - Minimum output low (sink) current characteristics.

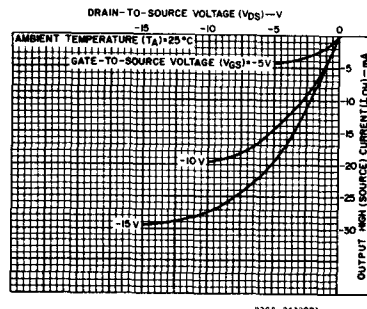

Fig. 7 - Typical output high (source) current characteristics.

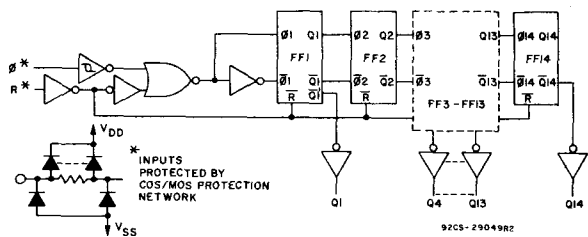

Fig. 1 - Logic diagram for CD4020B.

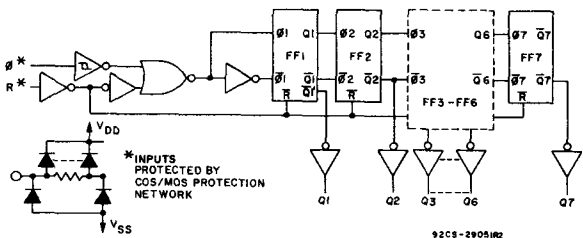

Fig. 2 - Logic diagram for CD4024B.

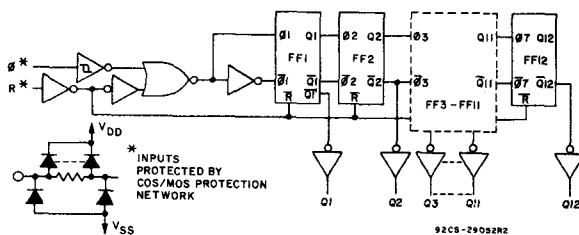

Fig. 3 - Logic diagram for CD4040B.

# CD4020B, CD4024B, CD4040B Types

## STATIC ELECTRICAL CHARACTERISTICS

CHARACTERISTIC	CONDITIONS			LIMITS AT INDICATED TEMPERATURES (°C)							UNITS
	V <sub>O</sub> (V)	V <sub>IN</sub> (V)	V <sub>DD</sub> (V)	Values at -55, +25, +125 Apply to D, F, K, H Packages				Values at -40, +25, +85 Apply to E Package			
				-55	-40	+85	+125	Min.	Typ.	Max.	
Quiescent Device Current, I <sub>DD</sub> Max.	-	0.5	5	5	5	150	150	-	0.04	5	μA
	-	0.10	10	10	10	300	300	-	0.04	10	
	-	0.15	15	20	20	600	600	-	0.04	20	
	-	0.20	20	100	100	3000	3000	-	0.08	100	
Output Low (Sink) Current I <sub>OL</sub> Min.	0.4	0.5	5	0.64	0.61	0.42	0.36	0.51	1	-	mA
	0.5	0.10	10	1.6	1.5	1.1	0.9	1.3	2.6	-	
	1.5	0.15	15	4.2	4	2.8	2.4	3.4	6.8	-	
Output High (Source) Current, I <sub>OH</sub> Min.	4.6	0.5	5	-0.64	-0.61	-0.42	-0.36	-0.51	-1	-	mA
	2.5	0.5	5	-2	-1.8	-1.3	-1.15	-1.6	-3.2	-	
	9.5	0.10	10	-1.6	-1.5	-1.1	-0.9	-1.3	-2.6	-	
Output Voltage: Low-Level, V <sub>OL</sub> Max.	-	0.5	5	0.05				-	0	0.05	V
	-	0.10	10	0.05				-	0	0.05	
	-	0.15	15	0.05				-	0	0.05	
Output Voltage: High-Level, V <sub>OH</sub> Min.	-	0.5	5	4.95				4.95	5	-	V
	-	0.10	10	9.95				9.95	10	-	
	-	0.15	15	14.95				14.95	15	-	
Input Low Voltage, V <sub>IL</sub> Max.	0.5, 4.5	-	5	1.5				-	-	1.5	V
	1, 9	-	10	3				-	-	3	
	1.5, 13.5	-	15	4				-	-	4	
Input High Voltage, V <sub>IH</sub> Min.	0.5, 4.5	-	5	3.5				3.5	-	-	V
	1, 9	-	10	7				7	-	-	
	1.5, 13.5	-	15	11				11	-	-	
Input Current I <sub>IN</sub> Max.	-	0.18	18	±0.1	±0.1	±1	±1	-	±10 <sup>-5</sup>	±0.1	μA

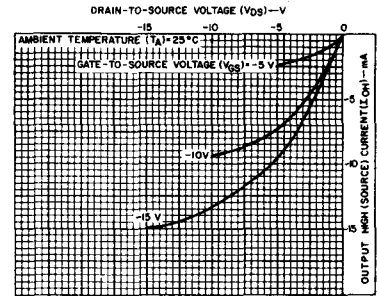

Fig. 8 - Minimum output high (source) current characteristics.

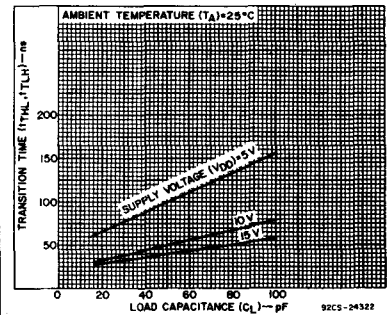
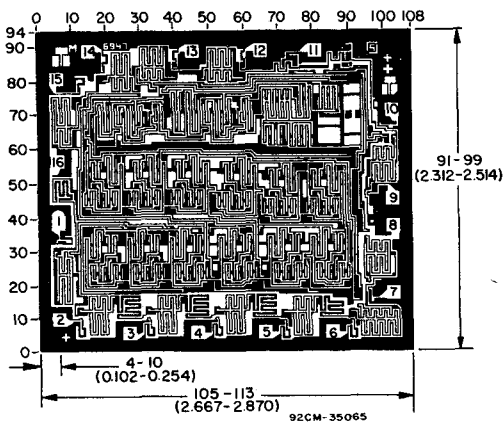
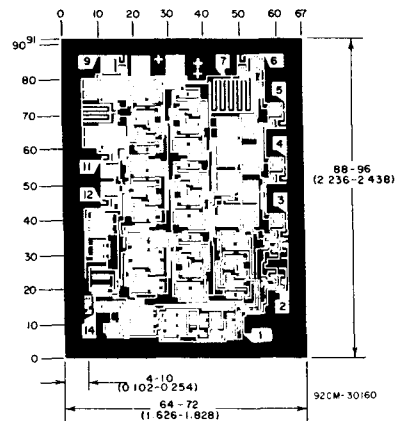

Fig. 9 - Typical transition time as a function of load capacitance.



Dimensions and Pad Layout for CD4020BH. Dimensions and pad layout for CD4040BH are identical.

Dimensions in parentheses are in millimeters and are derived from the basic inch dimensions as indicated. Grid graduations are in mils (10<sup>-3</sup> inch).



Dimensions and Pad Layout for CD4024BH.

The photographs and dimensions of each CMOS chip represent a chip when it is part of the wafer. When the wafer is separated into individual chips, the angle of cleavage may vary with respect to the chip face for different chips. The actual dimensions of the isolated chip, therefore, may differ slightly from the nominal dimensions shown. The user should consider a tolerance of -3 mils to +16 mils applicable to the nominal dimensions shown.

# CD4020B, CD4024B, CD4040B Types

DYNAMIC ELECTRICAL CHARACTERISTICS at  $T_A = 25^\circ\text{C}$ , Input  $t_r, t_f = 20\text{ ns}$ ,  
 $C_L = 50\text{ pF}$ ,  $R_L = 200\text{ k}\Omega$

CHARACTERISTIC	TEST CONDITIONS	$V_{DD}$ (V)	LIMITS			UNITS
			Min.	Typ.	Max.	
<b>Input-Pulse Operation</b>						
Propagation Delay Time, $\phi$ to $Q_1$ Out; $t_{PHL}, t_{PLH}$		5	—	180	360	ns
		10	—	80	160	
		15	—	65	130	
$Q_n$ to $Q_{n+1}$ ; $t_{PHL}, t_{PLH}$		5	—	100	200	ns
		10	—	40	80	
		15	—	30	60	
Transition Time, $t_{THL}, t_{TLH}$		5	—	100	200	ns
		10	—	50	100	
		15	—	40	80	
Minimum Input-Pulse Width, $t_W$		5	—	70	140	ns
		10	—	30	60	
		15	—	20	40	
Input-Pulse Rise or Fall Time, $t_{r\phi}, t_{f\phi}$		5	Unlimited			$\mu\text{s}$
		10				
		15				
Maximum Input-Pulse Frequency, $f_\phi$		5	3.5	7	—	MHz
		10	8	16	—	
		15	12	24	—	
Input Capacitance, $C_I$	Any Input		—	5	7.5	pF
<b>Reset Operation</b>						
Propagation Delay Time, $t_{PHL}$		5	—	140	280	ns
		10	—	60	120	
		15	—	50	100	
Minimum Reset Pulse Width, $t_W$		5	—	100	200	ns
		10	—	40	80	
		15	—	30	60	
Reset Removal Time, $t_{REM}$		5	—	175	350	ns
		10	—	75	150	
		15	—	50	100	

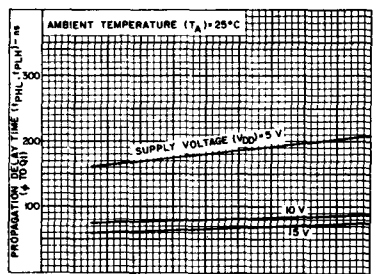

Fig. 10 - Typical propagation delay time as a function of load capacitance ( $\phi$  to  $Q_1$ ).

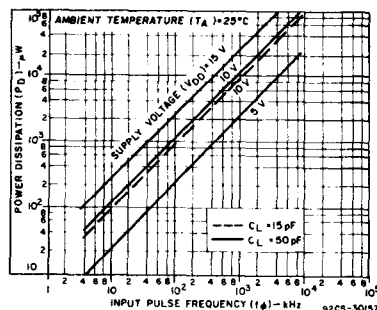

Fig. 11 - Typical dynamic power dissipation as a function of input pulse frequency for CD4020B.

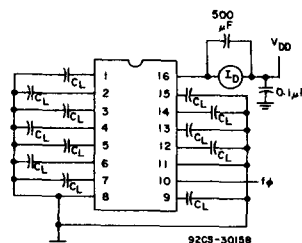

Fig. 12 - Dynamic power dissipation test circuit for CD4020B.

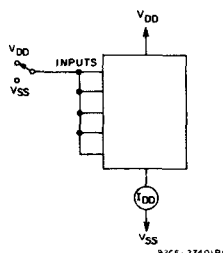

Fig. 13 - Quiescent device current test circuit.

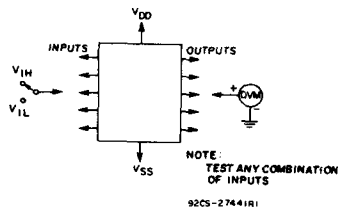

Fig. 14 - Input voltage test circuits.

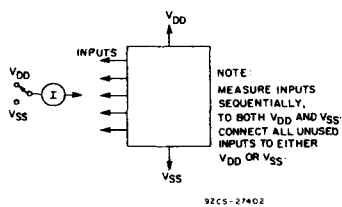

Fig. 15 - Input current test circuit.

# CD4026B, CD4033B Types

## CMOS Decade Counters/Dividers

High-Voltage Types (20-Volt Rating)  
 With Decoded 7-Segment Display Outputs and:  
 Display Enable – CD4026B  
 Ripple Blanking – CD4033B

The RCA-CD4026B and CD4033B each consist of a 5-stage Johnson decade counter and an output decoder which converts the Johnson code to a 7-segment decoded output for driving one stage in a numerical display.

These devices are particularly advantageous in display applications where low power dissipation and/or low package count are important.

Inputs common to both types are CLOCK, RESET, & CLOCK INHIBIT; common outputs are CARRY OUT and the seven decoded outputs (a, b, c, d, e, f, g). Additional inputs and outputs for the CD4026B include DISPLAY ENABLE input and DISPLAY ENABLE and UNGATED "C" SEGMENT" outputs. Signals peculiar to the CD4033B are RIPPLE-BLANKING INPUT AND LAMP TEST INPUT and a RIPPLE-BLANKING OUTPUT.

A high RESET signal clears the decade counter to its zero count. The counter is advanced one count at the positive clock signal transition if the CLOCK INHIBIT signal is low. Counter advancement via the clock line is inhibited when the CLOCK INHIBIT signal is high. The CLOCK INHIBIT signal can be used as a negative-edge clock if the clock line is held high. Antilock gating is provided on the JOHNSON counter, thus assuring proper counting sequence. The CARRY-OUT ( $C_{out}$ ) signal completes one cycle every ten CLOCK INPUT cycles and is used to clock the succeeding decade directly in a multi-decade counting chain. The seven decoded outputs (a, b, c, d, e, f, g) illuminate the proper segments in a seven

### Features:

- Counter and 7-segment decoding in one package
- Easily interfaced with 7-segment display types
- Fully static counter operation: DC to 6 MHz (typ.) at  $V_{DD}=10\text{ V}$
- Ideal for low-power displays
- Display enable output (CD4026B)
- "Ripple blanking" and lamp test (CD4033B)
- 100% tested for quiescent current at 20 V
- Standardized, symmetrical output characteristics
- 5-V, 10-V, and 15-V parametric ratings
- Schmitt-triggered clock inputs
- Meets all requirements of JEDEC Tentative Standard No. 13A, "Standard Specifications for Description of 'B' Series CMOS Devices"

### Applications

- Decade counting 7-segment decimal display
- Frequency division 7-segment decimal displays
- Clocks, watches, timers (e.g.  $\div 60, \div 60, \div 12$  counter/display)
- Counter/display driver for meter applications

segment display device used for representing the decimal numbers 0 to 9. The 7-segment outputs go high on selection in the CD4033B; in the CD4026B these outputs go high only when the DISPLAY ENABLE IN is high.

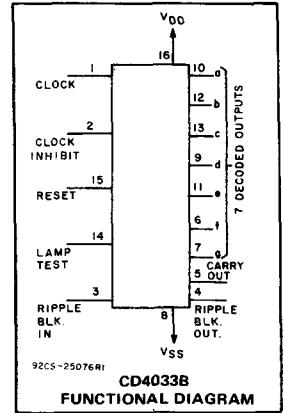
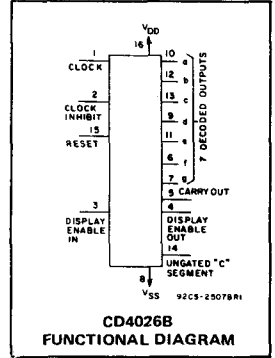

### MAXIMUM RATINGS, Absolute-Maximum Values:

DC SUPPLY-VOLTAGE RANGE, ( $V_{DD}$ ) (Voltages referenced to $V_{SS}$ Terminal)	-0.5 to +20 V
INPUT VOLTAGE RANGE, ALL INPUTS	-0.5 to $V_{DD} + 0.5\text{ V}$
DC INPUT CURRENT, ANY ONE INPUT	$\pm 10\text{ mA}$
POWER DISSIPATION PER PACKAGE ( $P_D$ ):	
For $T_A = -40$ to $+60^\circ\text{C}$ (PACKAGE TYPE E)	500 mW
For $T_A = +60$ to $+85^\circ\text{C}$ (PACKAGE TYPE E)	Derate Linearly at 12 mW/ $^\circ\text{C}$ to 200 mW
For $T_A = -55$ to $+100^\circ\text{C}$ (PACKAGE TYPES D, F, K)	500 mW
For $T_A = +100$ to $+125^\circ\text{C}$ (PACKAGE TYPES D, F, K)	Derate Linearly at 12 mW/ $^\circ\text{C}$ to 200 mW
DEVICE DISSIPATION PER OUTPUT TRANSISTOR	
For $T_A = \text{FULL PACKAGE-TEMPERATURE RANGE (All Package Types)}$	100 mW
OPERATING-TEMPERATURE RANGE ( $T_A$ ):	
PACKAGE TYPES D, F, K, H	-55 to $+125^\circ\text{C}$
PACKAGE TYPE E	-40 to $+85^\circ\text{C}$
STORAGE TEMPERATURE RANGE ( $T_{stg}$ )	-65 to $+150^\circ\text{C}$
LEAD TEMPERATURE (DURING SOLDERING):	
At distance $1/16 \pm 1/32$ inch (1.59 $\pm$ 0.79 mm) from case for 10 s max.	$+265^\circ\text{C}$

### TERMINAL DIAGRAMS

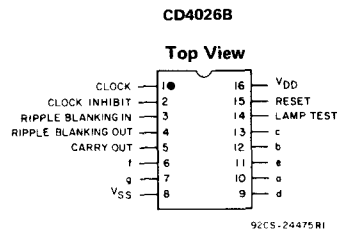
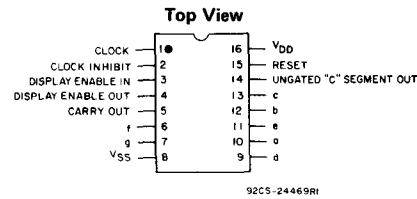



# CD4026B, CD4033B Types

## RECOMMENDED OPERATING CONDITIONS

For maximum reliability, nominal operating conditions should be selected so that operation is always within the following ranges:

CHARACTERISTIC	VDD (V)	LIMITS		UNITS
		MIN.	MAX.	
Supply-Voltage Range (For $T_A$ = Full Package Temperature Range)		3	18	V
Clock Input Frequency, $f_{CL}$	5	—	2.5	MHz
	10	—	5.5	
	15	—	8	
Clock Pulse Width, $t_{WCL}$	5	220	—	
	10	100	—	
	15	80	—	
Clock Rise and Fall Time, $t_{rCL}$ , $t_{fCL}$	5	—	Unlimited	
	10	—		
	15	—		
Clock Inhibit Set Up Time, $t_{SU}$	5	200	—	ns
	10	50	—	
	15	30	—	
Reset Pulse Width, $t_W$	5	200	—	
	10	100	—	
	15	50	—	
Reset Removal Time	5	30	—	
	10	15	—	
	15	10	—	

## CD4026B

When the DISPLAY ENABLE IN is low the seven decoded outputs are forced low regardless of the state of the counter. Activation of the display only when required results in significant power savings. This system also facilitates implementation of display-character multiplexing.

The CARRY OUT and UNGATED "CSEGMENT" signals are not gated by the DISPLAY ENABLE and therefore are available continuously. This feature is a requirement in implementation of certain divider functions such as divide-by-60 and divide-by-12.

## CD4033B

The CD4033B has provisions for automatic blanking of the non-significant zeros in a multi-digit decimal number which results in an easily readable display consistent with normal writing practice. For example, the number 0050.0700 in an eight digit display would be displayed as 50.07. Zero suppression on the integer side is obtained by connecting the RBI terminal of the CD4033B associated with the most significant digit in the display to a low-level voltage and connecting the RBO terminal of that stage to the RBI terminal of the CD4033B in the next-lower significant position in the display. This procedure is continued for each succeeding CD4033B on the integer side of the display.

On the fraction side of the display the RBI of the CD4033B associated with the least significant bit is connected to a low-level voltage and the RBO of that CD4033B is connected to the RBI terminal of the CD4033B in the next more-significant-bit position. Again, this procedure is continued for all CD4033B's on the fraction side of the display.

In a purely fractional number the zero immediately preceding the decimal point can be displayed by connecting the RBI of that stage to a high level voltage (instead of to the RBO of the next more-significant-stage). For example: optional zero → 0.7346. Likewise, the zero in a number such as 763.0 can be displayed by connecting the RBI of the CD4033B associated with it to a high-level voltage.

Ripple blanking of non-significant zeros provides an appreciable savings in display power.

The CD4033B has a LAMP TEST input which, when connected to a high-level voltage, overrides normal decoder operation and enables a check to be made on possible display malfunctions by putting the seven outputs in the high state.

The CD4026B- and CD4033B-series types are supplied in 16-lead hermetic dual-in-line ceramic packages (D and F suffixes), 16-lead dual-in-line plastic packages (E suffix), 16-lead ceramic flat packages (K suffix), and in chip form (H suffix).

## STATIC ELECTRICAL CHARACTERISTICS

CHARACTERISTIC	CONDITIONS			LIMITS AT INDICATED TEMPERATURES (°C)							UNITS
				Values at -55, +25, +125 Apply to D, F, K, H Packages Values at -40, +25, +85 Apply to E Package							
	VO (V)	VIN (V)	VDD (V)	-55	-40	+85	+125	Min.	Typ.	Max.	
Quiescent Device Current, $I_{DD}$ Max.	—	0,5	5	5	5	150	150	—	0.04	5	$\mu$ A
	—	0,10	10	10	10	300	300	—	0.04	10	
	—	0,15	15	20	20	600	600	—	0.04	20	
	—	0,20	20	100	100	3000	3000	—	0.08	100	
Output Low (Sink) Current $I_{OL}$ Min.	0.4	0,5	5	0.64	0.61	0.42	0.36	0.51	1	—	mA
	0.5	0,10	10	1.6	1.5	1.1	0.9	1.3	2.6	—	
	1.5	0,15	15	4.2	4	2.8	2.4	3.4	6.8	—	
Output High (Source) Current, $I_{OH}$ Min.	4.6	0,5	5	-0.64	-0.61	-0.42	-0.36	-0.51	-1	—	mA
	2.5	0,5	5	-2	-1.8	-1.3	-1.15	-1.6	-3.2	—	
	9.5	0,10	10	-1.6	-1.5	-1.1	-0.9	-1.3	-2.6	—	
	13.5	0,15	15	-4.2	-4	-2.8	-2.4	-3.4	-6.8	—	
Output Voltage: Low-Level, $V_{OL}$ Max.	—	0,5	5	0.05				—	0	0.05	V
	—	0,10	10	0.05				—	0	0.05	
	—	0,15	15	0.05				—	0	0.05	
Output Voltage: High-Level, $V_{OH}$ Min.	—	0,5	5	4.95				4.95	5	—	V
	—	0,10	10	9.95				9.95	10	—	
	—	0,15	15	14.95				14.95	15	—	
Input Low Voltage, $V_{IL}$ Max.	0.5, 4.5	—	5	1.5				—	—	1.5	V
	1, 9	—	10	3				—	—	3	
	1.5, 13.5	—	15	4				—	—	4	
Input High Voltage, $V_{IH}$ Min.	0.5, 4.5	—	5	3.5				3.5	—	—	V
	1, 9	—	10	7				7	—	—	
	1.5, 13.5	—	15	11				11	—	—	
Input Current $I_{IN}$ Max.	—	0,18	18	±0.1	±0.1	±1	±1	—	±10 <sup>-5</sup>	±0.1	$\mu$ A

# CD4026B, CD4033B Types

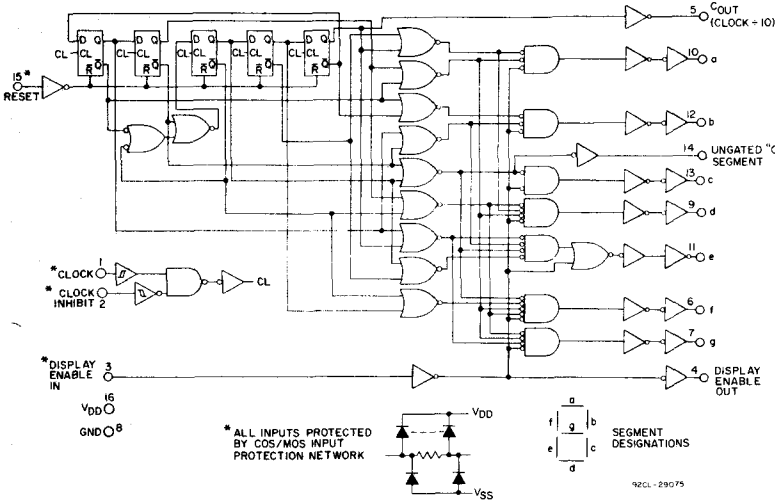

Fig. 1 - CD4026B logic diagram.

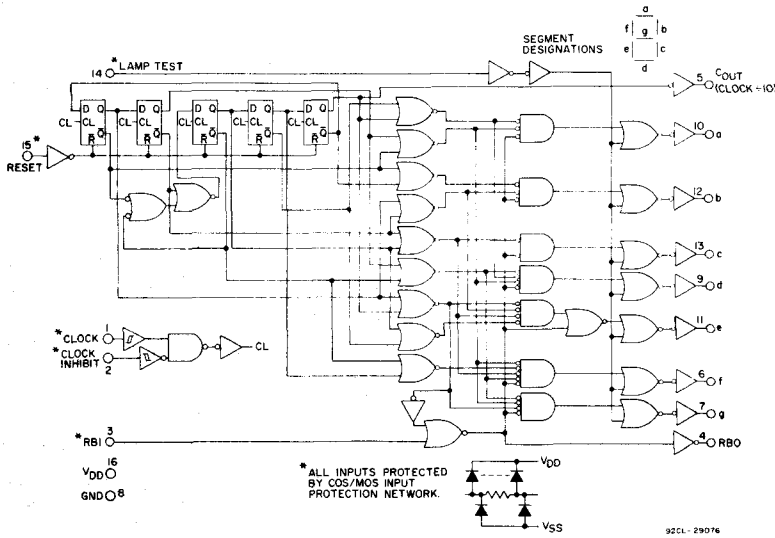

Fig. 2 - CD4033B logic diagram.

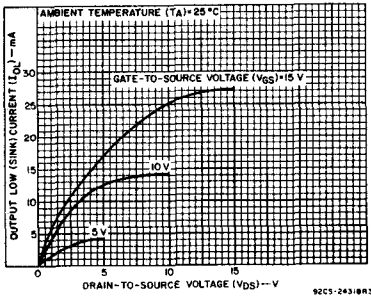

Fig. 6 - Typical n-channel output low (sink) current characteristics.

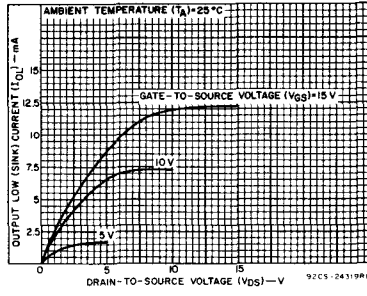

Fig. 7 - Minimum n-channel output low (sink) current characteristics.

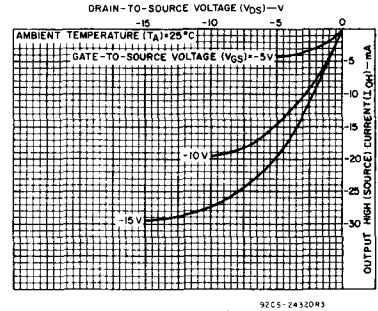

Fig. 8 - Typical p-channel output high (source) current characteristics.

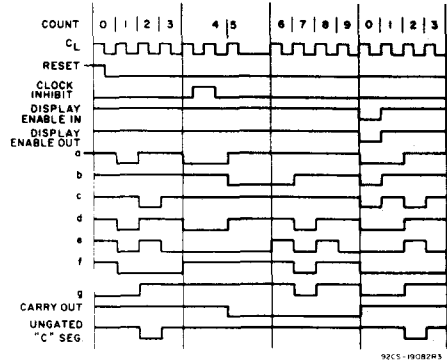

Fig. 3 - CD4026B timing diagram.

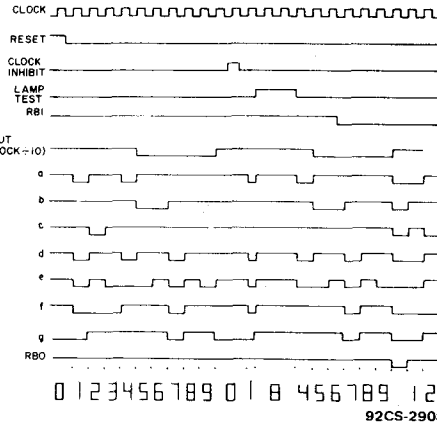

Fig. 4 - CD4033B timing diagram.

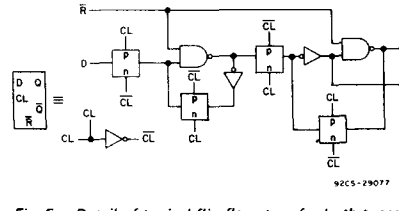

Fig. 5 - Detail of typical flip-flop stage for both types.

# CD4026B, CD4033B Types

**DYNAMIC ELECTRICAL CHARACTERISTICS** at  $T_A = 25^\circ\text{C}$ . Input  $t_r, t_f = 20\text{ ns}$ ,  
 $C_L = 50\text{ pF}$ ,  $R_L = 200\text{ k}\Omega$

CHARACTERISTIC	TEST CONDITIONS	LIMITS			UNITS	
		VDD (V)	Min.	Typ.		Max.
<b>CLOCKED OPERATION</b>						
Propagation Delay Time; Carry-Out Line $t_{PLH}, t_{PHL}$		5	—	250	500	
		10	—	100	200	
		15	—	75	150	
Decode Outlines		5	—	350	700	ns
		10	—	125	250	
		15	—	90	180	
Transition Time; Carry-Out Line $t_{THL}, t_{TLH}$		5	—	100	200	
		10	—	50	100	
		15	—	25	50	
Maximum Clock Input Frequency, $f_{CL}\Delta$		5	2.5	5	—	MHz
		10	5.5	11	—	
		15	8	16	—	
Min. Clock Pulse Width, $t_W$		5	—	110	220	
		10	—	50	100	
		15	—	40	80	
Clock and Clock Inhibit Rise or Fall Time; $t_{rCL}, t_{fCL}$		5	Unlimited		ns	
		10	Unlimited			
		15	Unlimited			
Average Input Capacitance, $C_{IN}$	Any Input	—	5	7	pF	
<b>RESET OPERATION</b>						
Propagation Delay Time; To Carry-Out Line, $t_{PLH}$		5	—	275	550	
		10	—	120	240	
		15	—	80	160	
To Decode Out Lines, $t_{PHL}, t_{PLH}$		5	—	300	600	ns
		10	—	125	250	
		15	—	90	180	
Min. Reset Pulse Width, $t_W$		5	—	100	120	
		10	—	50	100	
		15	—	25	50	
Min. Reset Removal Time		5	—	0	30	
		10	—	0	15	
		15	—	0	10	

$\Delta$  Measured with respect to carry-out line.

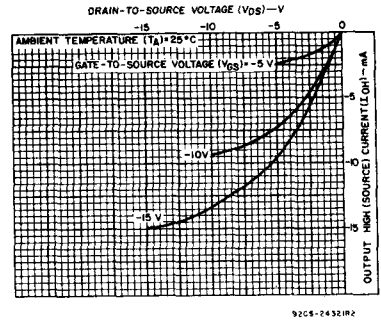

Fig. 9 — Minimum p-channel output high (source) current characteristics.

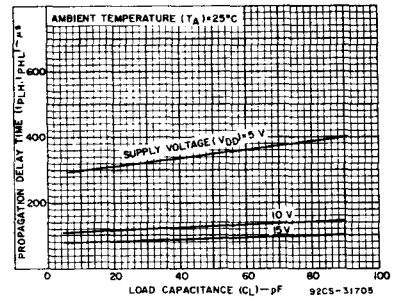

Fig. 10 — Typical propagation delay time as a function of load capacitance for decoded outputs.

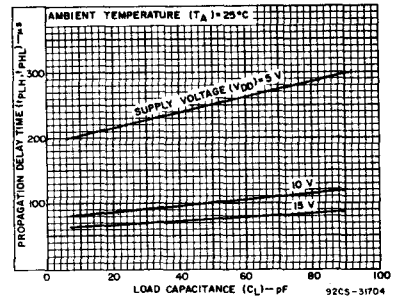

Fig. 11 — Typical propagation delay time as a function of load capacitance for carry-out outputs.

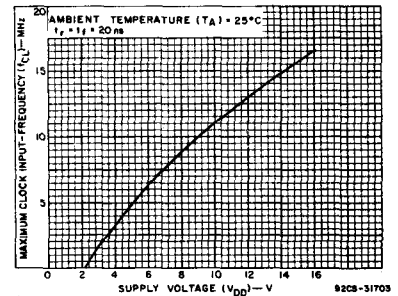

Fig. 12 — Typical maximum clock input frequency as a function of supply voltage.

# CD4026B, CD4033B Types

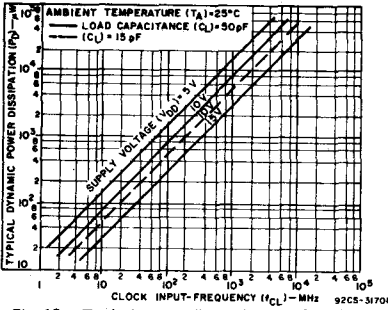

Fig. 13 - Typical power dissipation as a function of clock input frequency.

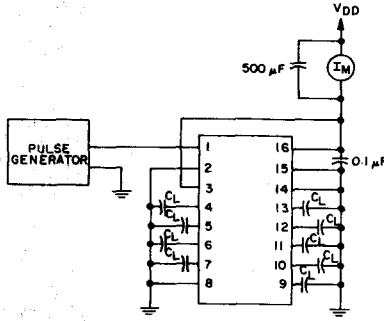

Fig. 14 - Dynamic power dissipation test circuit for CD4033B.

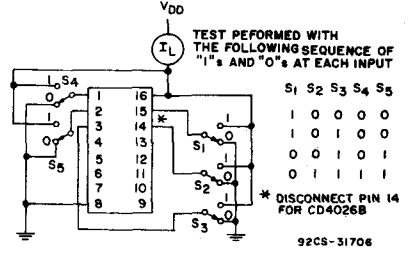
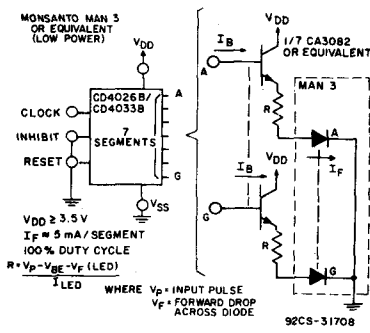
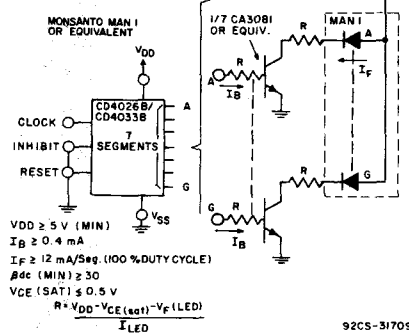

Fig. 15 - Quiescent device current.

## INTERFACING THE CD4026B AND CD4033B WITH COMMERCIALY AVAILABLE LIGHT EMITTING DIODE DISPLAYS



92CS-31708



92CS-31709

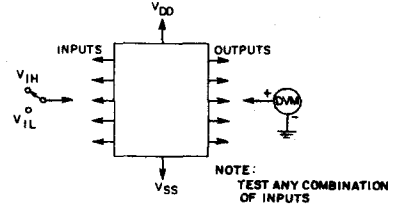
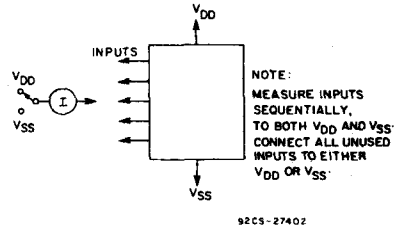
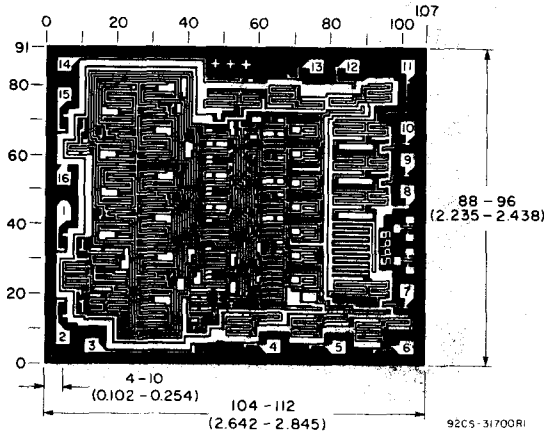

Fig. 16 - Input voltage.



92CS-27402

Fig. 17 - Input current.



Dimensions and pad layout for CD4026B.

Dimensions in parentheses are in millimeters and are derived from the basic inch dimensions as indicated. Grid graduations are in mils (10<sup>-3</sup> inch).

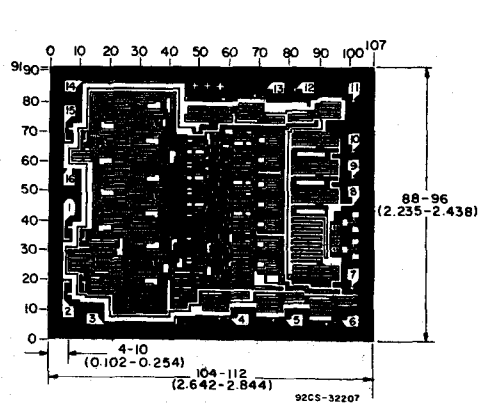

Dimensions and pad layout for CD4033B.

The photographs and dimensions of each CMOS chip represent a chip when it is part of the wafer. When the wafer is separated into individual chips, the angle of cleavage may vary with respect to the chip face for different chips. The actual dimensions of the isolated chip, therefore, may differ slightly from the nominal dimensions shown. The user should consider a tolerance of -3 mils to +16 mils applicable to the nominal dimensions shown.

# CD4026B, CD4033B Types

## INTERFACING THE CD4026B AND CD4033B WITH COMMERCIALY AVAILABLE 7-SEGMENT DISPLAY DEVICES\*

(Refer to RCA Application Note ICAN-6733 for detailed interfacing information)

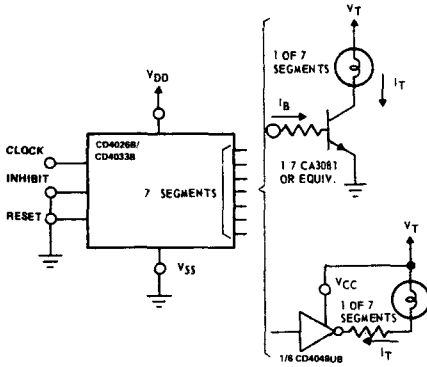

### INCANDESCENT READOUTS RCA Numitron DR2000 Series TUBE REQUIREMENTS

$V_T = 3.5\text{--}5\text{V}$   
 $I_T \approx 24\text{ mA Segment}$

ASSUMED TRANSISTOR CHARACTERISTICS @  $V_{CC} = 10\text{ V (min.)}$   
 $\beta_{dc} (\text{min.}) \geq 25$   
 $V_{CE(\text{sat.})} \leq 0.5\text{ V}$   
 $V_{DD} = 8\text{ V (min.)}$   
 $I_B = 1\text{ mA (min.)}$   
 $I_T = 24\text{ mA (min.)}$

CD4049UB

@  $V_{CC} = 10\text{ V (min.)}$   
 $V_o "0" \leq 2\text{ V}$   
 $I_T \approx 3.5\text{ V TO } 6\text{ V}$

CD4049UB

@  $V_{CC} = 10\text{ V (min.)}$   
 $V_o "0" \leq 0.6\text{ V}$   
 $I_T = 8\text{ mA (min.)}$

@  $V_{CC} = 6\text{ V (min.)}$   
 $V_o "0" \leq 1\text{ V}$   
 $I_T = 5\text{ mA (min.)}$   
 $V_T \approx 1.5\text{ V TO } 3.5\text{ V}$

### LOW-POWER INCANDESCENT READOUTS

PINLITES INC-Series O and R

TUBE REQUIREMENTS	$V_T$ (V)	mA/Segment
O-03-15	1.5	8
O-04-30	3	8
O-06-30	3	8
R-R3-20	2	4.3
R-R4-30	3	4.3

### ASSUMED TRANSISTOR CHARACTERISTICS

$\beta_{dc} (\text{min.}) \geq 30$   
 $V_{CE(\text{sat.})} \leq 0.5\text{ V}$   
 $V_{CC} \geq 3.5\text{ V (min.)}$   
 $I_B \geq 0.25\text{ mA (min.)}$   
 $I_T \leq 7.5\text{ mA (min.)}$

92CM-31707

\* The interfacing buffers shown, while a necessity with the CD4026A and CD4033A, are not required when using the "B" devices; the "B" outputs ( $\approx 10$  times the "A" outputs) can drive most display devices directly especially at voltages above 10 V.

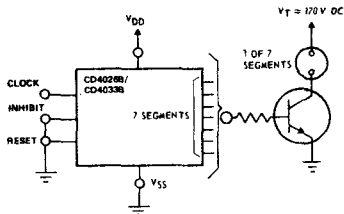

### NEON READOUT (NIXIE TUBE\*)

- Alco Electronics - MG19
- Burroughs - B5971, B7971, B8971

TUBE REQUIREMENTS	$V_T$ (Vdc)	mA Segment
Alco MG19	180	0.5
Burroughs B5971	170	3
Burroughs B7971, B8971	170	6

\* (Trademark) Burroughs Corp.

### TRANSISTOR CHARACTERISTICS

Leakage with transistor cutoff - 0.05 mA

$V_{(BR)CER} > V_T$

$\beta_{dc} (\text{min.}) \geq 30$

92CS-31710

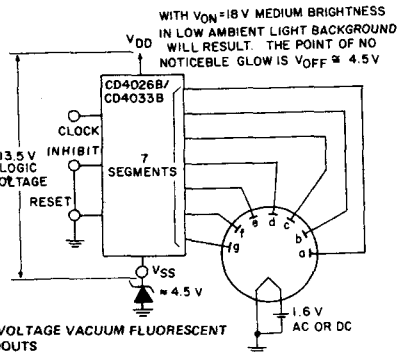

### LOW VOLTAGE VACUUM FLUORESCENT READOUTS

- Tung-Sol DIGIVAC S/G ‡ Type DT1704A or DT1705C
  - Nippon Electric (NEC); Type DG12E or LD915
- TUBE REQUIREMENTS: 100 to 300  $\mu\text{A}$ /segment at tube voltages of 12 V to 25 V depending on required brightness. Filament requirement 45 mA at 1.6 V, ac or dc.

‡ (Trademark) Wagner Electric Co.

92CS-31711

# CD4027B Types

## CMOS Dual J-K Master-Slave Flip-Flop

### High-Voltage Types (20-Volt Rating)

The RCA-CD4027B is a single monolithic chip integrated circuit containing two identical complementary-symmetry J-K master-slave flip-flops. Each flip-flop has provisions for individual J, K, Set, Reset, and Clock input signals. Buffered Q and Q signals are provided as outputs. This input-output arrangement provides for compatible operation with the RCA-CD4013B dual D-type flip-flop.

The CD4027B is useful in performing control, register, and toggle functions. Logic levels present at the J and K inputs along with internal self-steering control the state of each flip-flop; changes in the flip-flop state are synchronous with the positive-going transition of the clock pulse. Set and reset functions are independent of the clock and are initiated when a high level signal is present at either the Set or Reset input.

The CD4027B types are supplied in 16-lead hermetic dual-in-line ceramic packages (D and F suffixes), 16-lead dual-in-line plastic packages (E suffix), 16-lead ceramic flat packages (K suffix), and in chip form (H suffix).

### Features:

- Set-Reset capability
- Static flip-flop operation — retains state indefinitely with clock level either "high" or "low"
- Medium speed operation — 16 MHz (typ.) clock toggle rate at 10 V
- Standardized symmetrical output characteristics
- 100% tested for quiescent current at 20 V
- Maximum input current of 1  $\mu$ A at 18 V over full package-temperature range; 100 nA at 18 V and 25°C
- Noise margin (over full package-temperature range):
  - 1 V at  $V_{DD} = 5$  V
  - 2 V at  $V_{DD} = 10$  V
  - 2.5 V at  $V_{DD} = 15$  V
- 5-V, 10-V, and 15-V parametric ratings
- Meets all requirements of JEDEC Tentative Standard No. 13A, "Standard Specifications for Description of 'B' Series CMOS Devices"

### Applications:

- Registers, counters, control circuits

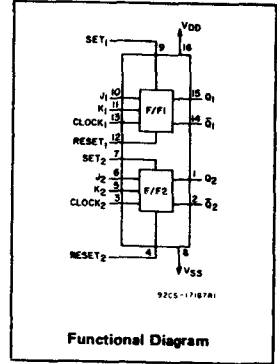

### MAXIMUM RATINGS, Absolute-Maximum Values:

DC SUPPLY-VOLTAGE RANGE, ( $V_{DD}$ )	..... -0.5 to +20 V
(Voltages referenced to $V_{SS}$ Terminal)	
INPUT VOLTAGE RANGE, ALL INPUTS	..... -0.5 to $V_{DD} + 0.5$ V
DC INPUT CURRENT, ANY ONE INPUT	..... $\pm 10$ $\mu$ A
POWER DISSIPATION PER PACKAGE ( $P_D$ ):	
For $T_A = -40$ to $+60^\circ$ C (PACKAGE TYPE E)	..... 500 mW
For $T_A = +60$ to $+85^\circ$ C (PACKAGE TYPE E)	..... Derate Linearly at 12 mW/ $^\circ$ C to 200 mW
For $T_A = -55$ to $+100^\circ$ C (PACKAGE TYPES D, F, K)	..... 500 mW
For $T_A = +100$ to $+125^\circ$ C (PACKAGE TYPES D, F, K)	..... Derate Linearly at 12 mW/ $^\circ$ C to 200 mW
DEVICE DISSIPATION PER OUTPUT TRANSISTOR:	
For $T_A =$ FULL PACKAGE-TEMPERATURE RANGE (All Package Types)	..... 100 mW
OPERATING-TEMPERATURE RANGE ( $T_A$ ):	
PACKAGE TYPES D, F, K, H	..... $-55$ to $+125^\circ$ C
PACKAGE TYPE E	..... $-40$ to $+85^\circ$ C
STORAGE TEMPERATURE RANGE ( $T_{stg}$ )	..... $-65$ to $+150^\circ$ C
LEAD TEMPERATURE (DURING SOLDERING):	
At distance $1/16 \pm 1/32$ inch (1.59 $\pm$ 0.79 mm) from case for 10 s max.	..... $+265^\circ$ C

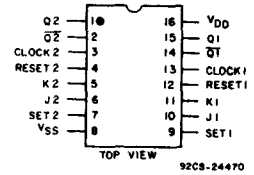

### TERMINAL ASSIGNMENT

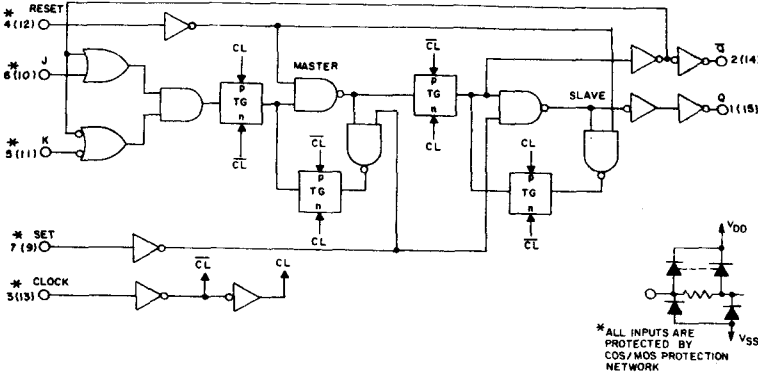

PRESENT STATE				CL*	NEXT STATE	
J	K	S	R		Q	Q
1	X	0	0	0	1	0
X	0	0	0	1	1	0
0	X	0	0	0	0	1
X	1	0	0	1	0	1
X	X	0	0	X	—	NO CHANGE
X	X	1	0	X	1	0
X	X	0	1	X	0	1
X	X	1	1	X	1	1

LOGIC 1 = HIGH LEVEL  
LOGIC 0 = LOW LEVEL  
\* STATE CHANGE  
X DONT CARE

92CM-27551R1

Fig. 1 — Logic diagram and truth table for CD4027B (one of two identical J-K flip flops).

# CD4027B Types

**RECOMMENDED OPERATING CONDITIONS at  $T_A = 25^\circ\text{C}$ , Except as Noted.**  
 For maximum reliability, nominal operating conditions should be selected so that operation is always within the following ranges:

CHARACTERISTIC	VDD (V)	LIMITS		UNITS	
		All Packages			
		Min.	Max.		
Supply-Voltage Range (For $T_A =$ Full Package Temperature Range)	—	3	18	V	
Data Setup Time	$t_S$	5 10 15	200 75 50	— — —	ns
Clock Pulse Width	$t_W$	5 10 15	140 60 40	— — —	ns
Clock Input Frequency (Toggle Mode)	$f_{CL}$	5 10 15	dc 8 12	— — —	MHz
Clock Rise or Fall Time	$t_{rCL}^*$ , $t_{fCL}$	5 10 15	— 5 2	— — —	$\mu\text{s}$
Set or Reset Pulse Width	$t_W$	5 10 15	180 80 50	— — —	ns

If more than one unit is cascaded in a parallel clocked operation,  $t_{rCL}$  should be made less than or equal to the sum of the fixed propagation delay time at 15 pF and the transition time of the output driving stage for the estimated capacitive load.

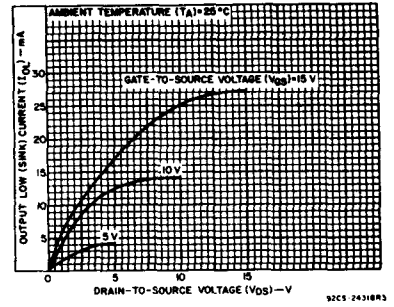

Fig. 2 - Typical output low (sink) current characteristics.

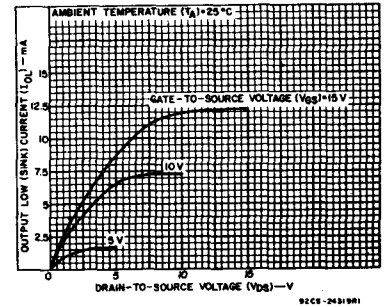

Fig. 3 - Minimum output low (sink) current characteristics.

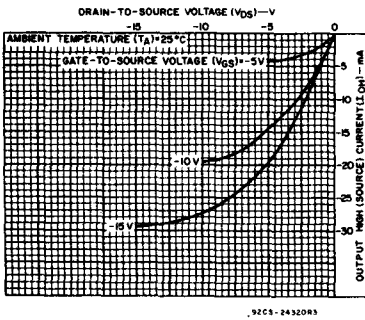

Fig. 4 - Typical output high (source) current characteristics.

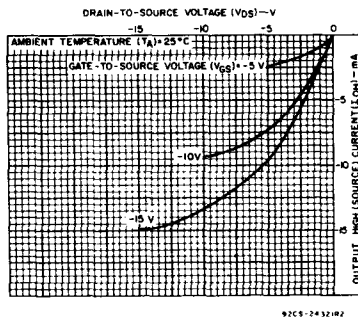

Fig. 5 - Minimum output high (source) current characteristics.

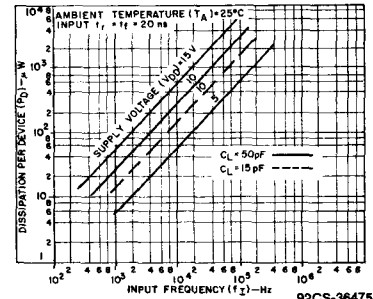

Fig. 6 - Typical power dissipation vs. frequency.

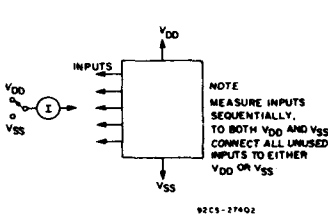

Fig. 7 - Input current test circuit.

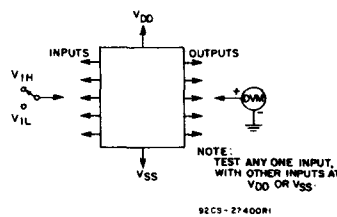

Fig. 8 - Input-voltage test circuit.

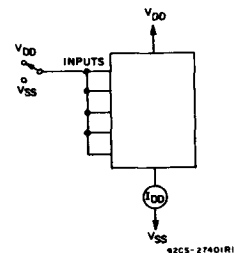
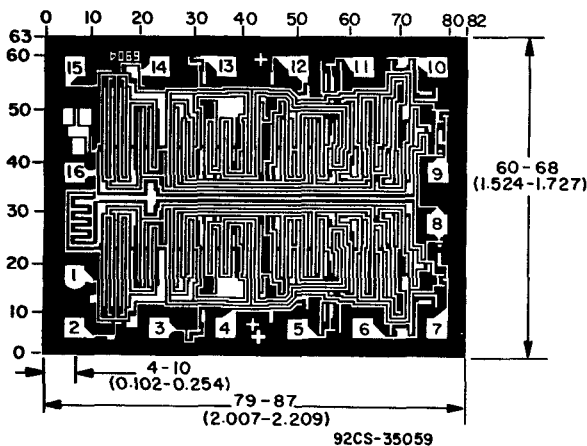

Fig. 9 - Quiescent device current test circuit.

# CD4027B Types

## STATIC ELECTRICAL CHARACTERISTICS

CHARACTERISTIC	CONDITIONS			LIMITS AT INDICATED TEMPERATURES (°C)							UNITS
	V <sub>O</sub> (V)	V <sub>IN</sub> (V)	V <sub>DD</sub> (V)	Values at -55, +25, +125 Apply to D, F, K, H Pkgs.				Values at -40, +25, +85 Apply to E Pkgs.			
				-55	-40	+85	+125	+25			
								Min.	Typ.	Max.	
Quiescent Device Current I <sub>DD</sub> Max.	-	0,5	5	1	1	30	30	-	0.02	1	μA
	-	0,10	10	2	2	60	60	-	0.02	2	
	-	0,15	15	4	4	120	120	-	0.02	4	
Output Low (Sink) Current I <sub>OL</sub> Min.	0.4	0,5	5	0.64	0.61	0.42	0.36	0.51	1	-	mA
	0.5	0,10	10	1.6	1.5	1.1	0.9	1.3	2.6	-	
	1.5	0,15	15	4.2	4	2.8	2.4	3.4	6.8	-	
Output High (Source) Current I <sub>OH</sub> Min.	4.6	0,5	5	-0.64	-0.61	-0.42	-0.36	-0.51	-1	-	mA
	2.5	0,5	5	-2	-1.8	-1.3	-1.15	-1.6	-3.2	-	
	9.5	0,10	10	-1.6	-1.5	-1.1	-0.9	-1.3	-2.6	-	
Output Voltage: Low-Level, V <sub>OL</sub> Max.	-	0,5	5	0.05				-	0	0.05	V
	-	0,10	10	0.05				-	0	0.05	
	-	0,15	15	0.05				-	0	0.05	
Output Voltage: High-Level, V <sub>OH</sub> Min.	-	0,5	5	4.95				4.95	5	-	V
	-	0,10	10	9.95				9.95	10	-	
	-	0,15	15	14.95				14.95	15	-	
Input Low Voltage, V <sub>IL</sub> Max.	0.5,4.5	-	5	1.5				-	-	1.5	V
	1,9	-	10	3				-	-	3	
	1.5,13.5	-	15	4				-	-	4	
Input High Voltage, V <sub>IH</sub> Min.	0.5,4.5	-	5	3.5				3.5	-	-	V
	1,9	-	10	7				7	-	-	
	1.5,13.5	-	15	11				11	-	-	
Input Current, I <sub>IN</sub> Max.	-	0,18	18	±0.1	±0.1	±1	±1	-	±10 <sup>-5</sup>	±0.1	μA



Dimensions in millimeters are derived from the basic inch dimensions as indicated. Grid graduations are in mils (10<sup>-3</sup>).

The photographs and dimensions of each CMOS chip represent a chip when it is part of the wafer. When the wafer is separated into individual chips, the angle of cleavage may vary with respect to the chip face for different chips. The actual dimensions of the isolated chip, therefore, may differ slightly from the nominal dimensions shown. The user should consider a tolerance of -3 mils to +16 mils applicable to the nominal dimensions shown.

Dimensions and Pad Layout for CD4027BH



# CD4027B Types

DYNAMIC ELECTRICAL CHARACTERISTICS at  $T_A = 25^\circ\text{C}$ ; Input  $t_r, t_f = 20 \text{ ns}$ ,  $C_L = 50 \text{ pF}$ ,  $R_L = 200 \text{ k}\Omega$

CHARACTERISTIC	VDD (V)	LIMITS			UNITS
		All Packages			
		Min.	Typ.	Max.	
Propagation Delay Time: Clock to Q or $\bar{Q}$ Outputs $t_{PHL}, t_{PLH}$	5	—	150	300	ns
	10	—	65	130	
	15	—	45	90	
Set to Q or Reset to $\bar{Q}$ $t_{PLH}$	5	—	150	300	ns
	10	—	65	130	
	15	—	45	90	
Set to $\bar{Q}$ or Reset to Q $t_{PHL}$	5	—	200	400	ns
	10	—	85	170	
	15	—	60	120	
Transition Time $t_{THL}, t_{TLH}$	5	—	100	200	ns
	10	—	50	100	
	15	—	40	80	
Maximum Clock Input Frequency# (Toggle Mode) $f_{CL}$	5	3.5	7	—	MHz
	10	8	16	—	
	15	12	24	—	
Minimum Clock Pulse Width $t_W$	5	—	70	140	ns
	10	—	30	60	
	15	—	20	40	
Minimum Set or Reset Pulse Width $t_W$	5	—	90	180	ns
	10	—	40	80	
	15	—	25	50	
Minimum Data Setup Time $t_S$	5	—	100	200	ns
	10	—	35	75	
	15	—	25	50	
Clock Input Rise or Fall Time $t_{rCL}, t_{fCL}$	5	—	—	45	$\mu\text{s}$
	10	—	—	5	
	15	—	—	2	
Input Capacitance $C_i$		—	5	7.5	pF

# Input  $t_r, t_f = 5 \text{ ns}$ .

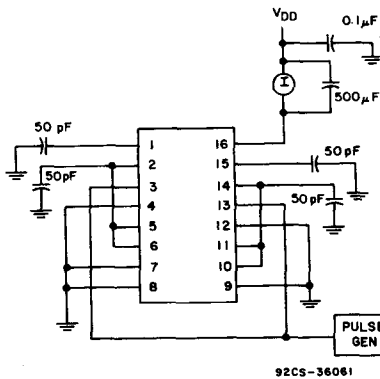

Fig. 13—Dynamic power dissipation test circuit.

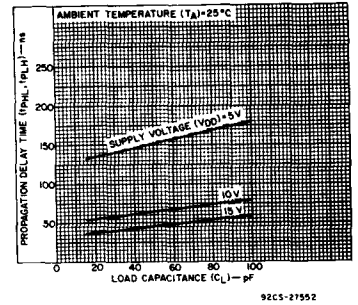

Fig. 10—Typical propagation delay time vs. load capacitance (CLOCK or SET to Q, CLOCK or RESET to Q).

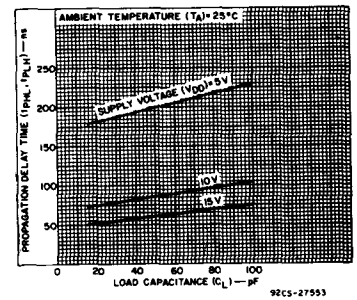

Fig. 11—Typical propagation delay time vs. load capacitance (SET to Q or RESET to Q).

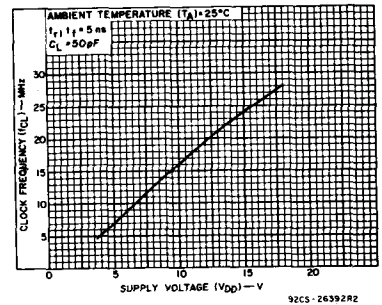

Fig. 12—Typical maximum clock frequency vs. supply voltage (toggle mode).

# CD4028B Types

## CMOS

### BCD-to-Decimal Decoder

High-Voltage Types (20-Volt Rating)

The RCA-CD4028B types are BCD-to-decimal or binary-to-octal decoders consisting of buffering on all 4 inputs, decoding logic gates, and 10 output buffers. A BCD code applied to the four inputs, A to D, results in a high level at the selected one of 10 decimal decoded outputs. Similarly, a 3-bit binary code applied to inputs A through C is decoded in octal code at output 0 to 7 if D = "0". High drive capability is provided at all outputs to enhance dc and dynamic performance in high fan-out applications.

The CD4028B-Series types are supplied in 16-lead hermetic dual-in-line ceramic packages (D and F suffixes), 16-lead dual-in-line plastic packages (E suffix), 16-lead ceramic flat packages (K suffix), and in chip form (H suffix).

#### Features:

- BCD-to-decimal decoding or binary-to-octal decoding
- High decoded output drive capability
- "Positive logic" inputs and outputs. . . . . decoded outputs go high on selection
- Medium-speed operation. . . . .  $t_{PHL}, t_{PLH} = 80 \text{ ns (typ.) @ } V_{DD} = 10 \text{ V}$
- Standardized, symmetrical output characteristics
- 100% tested for quiescent current at 20 V
- Maximum input current of 1  $\mu\text{A}$  at 18 V over full package-temperature range; 100 nA at 18 V and 25°C
- Noise margin (over full package-temperature range):  
1 V at  $V_{DD} = 5 \text{ V}$   
2 V at  $V_{DD} = 10 \text{ V}$   
2.5 V at  $V_{DD} = 15 \text{ V}$
- 5-V, 10-V, and 15-V parametric ratings
- Meets all requirements of JEDEC Tentative Standard No. 13A, "Standard Specifications for Description of 'B' Series CMOS Devices"

#### Applications:

- Code conversion
- Indicator-tube decoder
- Address decoding—memory selection control

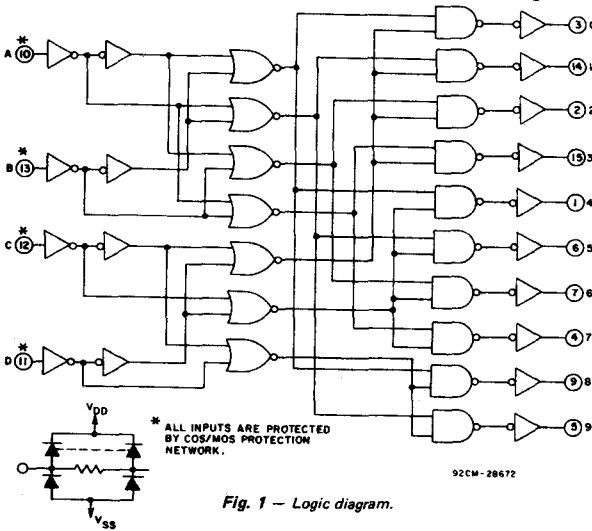
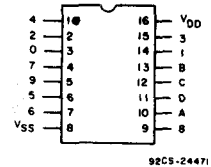
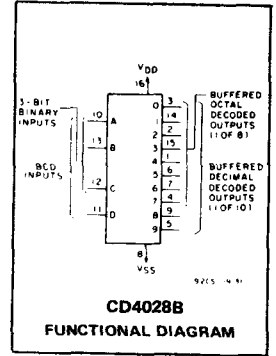

TABLE I — TRUTH TABLE

D	C	B	A	0	1	2	3	4	5	6	7	8	9
0	0	0	0	1	0	0	0	0	0	0	0	0	0
0	0	0	1	0	1	0	0	0	0	0	0	0	0
0	0	1	0	0	0	1	0	0	0	0	0	0	0
0	0	1	1	0	0	0	1	0	0	0	0	0	0
0	1	0	0	0	0	0	0	1	0	0	0	0	0
0	1	0	1	0	0	0	0	0	1	0	0	0	0
0	1	1	0	0	0	0	0	0	0	1	0	0	0
0	1	1	1	0	0	0	0	0	0	0	1	0	0
1	0	0	0	0	0	0	0	0	0	0	0	1	0
1	0	0	1	0	0	0	0	0	0	0	0	0	1
1	0	1	0	0	0	0	0	0	0	0	0	0	0
1	0	1	1	0	0	0	0	0	0	0	0	0	0
1	1	0	0	0	0	0	0	0	0	0	0	0	0
1	1	0	1	0	0	0	0	0	0	0	0	0	0
1	1	1	0	0	0	0	0	0	0	0	0	0	0
1	1	1	1	0	0	0	0	0	0	0	0	0	0

1 = HIGH LEVEL      0 = LOW LEVEL

#### MAXIMUM RATINGS, Absolute-Maximum Values:

- DC SUPPLY-VOLTAGE RANGE, ( $V_{DD}$ )  
(Voltages referenced to  $V_{SS}$  Terminal) . . . . . -0.5 to +20 V
- INPUT VOLTAGE RANGE, ALL INPUTS . . . . . -0.5 to  $V_{DD} + 0.5 \text{ V}$
- DC INPUT CURRENT, ANY ONE INPUT . . . . .  $\pm 10 \text{ mA}$
- POWER DISSIPATION PER PACKAGE ( $P_D$ ):  
For  $T_A = -40$  to  $+60^\circ\text{C}$  (PACKAGE TYPE E) . . . . . 500 mW  
For  $T_A = +60$  to  $+85^\circ\text{C}$  (PACKAGE TYPE E) . . . . . Derate Linearly at 12 mW/ $^\circ\text{C}$  to 200 mW  
For  $T_A = -55$  to  $+100^\circ\text{C}$  (PACKAGE TYPES D, F, K) . . . . . 500 mW  
For  $T_A = +100$  to  $+125^\circ\text{C}$  (PACKAGE TYPES D, F, K) . . . . . Derate Linearly at 12 mW/ $^\circ\text{C}$  to 200 mW
- DEVICE DISSIPATION PER OUTPUT TRANSISTOR  
For  $T_A = \text{FULL PACKAGE-TEMPERATURE RANGE (All Package Types)}$  . . . . . 100 mW
- OPERATING-TEMPERATURE RANGE ( $T_A$ ):  
PACKAGE TYPES D, F, K, H . . . . . -55 to  $+125^\circ\text{C}$   
PACKAGE TYPE E . . . . . -40 to  $+85^\circ\text{C}$
- STORAGE TEMPERATURE RANGE ( $T_{stg}$ ) . . . . . -65 to  $+150^\circ\text{C}$
- LEAD TEMPERATURE (DURING SOLDERING):  
At distance 1/16 ± 1/32 inch (1.59 ± 0.79 mm) from case for 10 s max. . . . .  $+265^\circ\text{C}$

# CD4028B Types

## RECOMMENDED OPERATING CONDITIONS

For maximum reliability, nominal operating conditions should be selected so that operation is always within the following ranges:

CHARACTERISTIC	LIMITS		UNITS
	MIN.	MAX.	
Supply Voltage Range (For $T_A$ = Full Package Temperature Range)	3	18	V

## STATIC ELECTRICAL CHARACTERISTICS

CHARACTERISTIC	CONDITIONS			LIMITS AT INDICATED TEMPERATURES (°C)							UNITS
	$V_O$ (V)	$V_{IN}$ (V)	$V_{DD}$ (V)	Values at -55, +25, +125 Apply to D, F, K, H Packages				Values at -40, +25, +85 Apply to E Package			
				-55	-40	+85	+125	Min.	Typ.	Max.	
Quiescent Device Current, $I_{DD}$ Max.	-	0.5	5	5	5	150	150	-	0.04	5	$\mu A$
	-	0.10	10	10	10	300	300	-	0.04	10	
	-	0.15	15	20	20	600	600	-	0.04	20	
Output Low (Sink) Current $I_{OL}$ Min.	0.4	0.5	5	0.64	0.61	0.42	0.36	0.51	1	-	mA
	0.5	0.10	10	1.6	1.5	1.1	0.9	1.3	2.6	-	
	1.5	0.15	15	4.2	4	2.8	2.4	3.4	6.8	-	
Output High (Source) Current, $I_{OH}$ Min.	4.6	0.5	5	-0.64	-0.61	-0.42	-0.36	-0.51	1	-	mA
	2.5	0.5	5	-2	-1.8	-1.3	-1.15	-1.6	-3.2	-	
	9.5	0.10	10	-1.6	-1.5	-1.1	-0.9	-1.3	-2.6	-	
Output Voltage: Low-Level, $V_{OL}$ Max.	-	0.5	5	-	-	0.05	-	0	0.05	-	V
	-	0.10	10	-	-	0.05	-	0	0.05	-	
	-	0.15	15	-	-	0.05	-	0	0.05	-	
Output Voltage: High-Level, $V_{OH}$ Min.	-	0.5	5	-	-	4.95	-	4.95	5	-	V
	-	0.10	10	-	-	9.95	-	9.95	10	-	
	-	0.15	15	-	-	14.95	-	14.95	15	-	
Input Low Voltage, $V_{IL}$ Max.	0.5, 4.5	-	5	-	-	1.5	-	-	1.5	-	V
	1.9	-	10	-	-	3	-	-	3	-	
	1.5, 13.5	-	15	-	-	4	-	-	4	-	
Input High Voltage, $V_{IH}$ Min.	0.5, 4.5	-	5	-	-	3.5	-	3.5	-	-	V
	1.9	-	10	-	-	7	-	7	-	-	
	1.5, 13.5	-	15	-	-	11	-	11	-	-	
Input Current $I_{IN}$ Max.	-	0.18	18	$\pm 0.1$	$\pm 0.1$	$\pm 1$	$\pm 1$	-	$\pm 10^{-5}$	$\pm 0.1$	$\mu A$

**DYNAMIC ELECTRICAL CHARACTERISTICS** at  $T_A = 25^\circ C$ ,  $C_L = 50$  pF, Input  $t_r, t_f = 20$  ns,  $R_L = 200$  k $\Omega$

CHARACTERISTIC	TEST CONDITIONS	LIMITS		UNITS
	$V_{DD}$ (V)	Typ.	Max.	
Propagation Delay Time: $t_{PHL}, t_{PLH}$	5	175	350	ns
	10	80	160	
	15	60	120	
Transition Time $t_{THL}, t_{TLH}$	5	100	200	ns
	10	50	100	
	15	40	80	
Input Capacitance, $C_{IN}$	-	5	7.5	pF

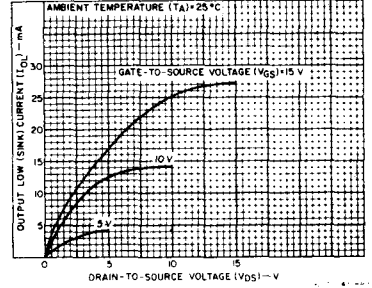

Fig. 2 — Typical output low (sink) current characteristics.

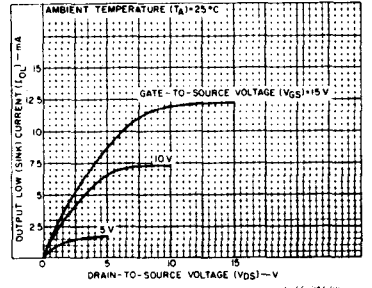

Fig. 3 — Minimum output low (sink) current characteristics.

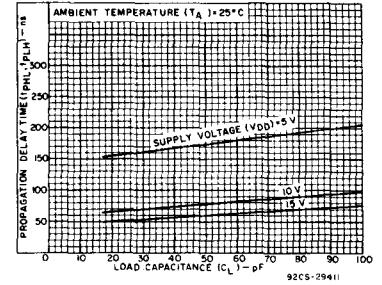

Fig. 4 — Typical propagation delay time as a function of load capacitance.

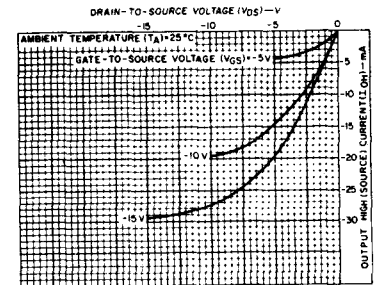

Fig. 5 — Typical output high (source) current characteristics.

# CD4028B Types

TABLE II — CODE CONVERSION CHART

INPUTS				INPUT CODES					OUTPUT NUMBER																		
				Hexa-Decimal		Decimal																					
D	C	B	A	4-BIT BINARY	4-BIT GRAY	EXCESS-3	EXCESS-3 GRAY	AIKEN	4-2-2-1	0	1	2	3	4	5	6	7	8	9	10	11	12	13	14	15		
0	0	0	0	0	0					0	1	0	0	0	0	0	0	0	0	0	0	0	0	0	0	0	
0	0	0	1	1	1					1	1	0	0	0	0	0	0	0	0	0	0	0	0	0	0	0	
0	0	1	0	2	3					0	2	0	1	0	0	0	0	0	0	0	0	0	0	0	0	0	
0	0	1	1	3	2					0	3	0	0	1	0	0	0	0	0	0	0	0	0	0	0	0	
0	1	0	0	4	7					1	4	0	0	0	0	1	0	0	0	0	0	0	0	0	0	0	
0	1	0	1	5	6					2		0	0	0	0	0	1	0	0	0	0	0	0	0	0	0	
0	1	1	0	6	4					3		0	0	0	0	0	0	1	0	0	0	0	0	0	0	0	
0	1	1	1	7	5					4		0	0	0	0	0	0	0	1	0	0	0	0	0	0	0	
1	0	0	0	8	15					5		0	0	0	0	0	0	0	0	1	0	0	0	0	0	0	
1	0	0	1	9	14					6		0	0	0	0	0	0	0	0	0	1	0	0	0	0	0	
1	0	1	0	10	12					7		0	0	0	0	0	0	0	0	0	0	1	0	0	0	0	
1	0	1	1	11	13					8		0	0	0	0	0	0	0	0	0	0	0	1	0	0	0	
1	1	0	0	12	8					9		0	0	0	0	0	0	0	0	0	0	0	0	1	0	0	
1	1	0	1	13	9					6		7	7	0	0	0	0	0	0	0	0	0	0	0	1	0	
1	1	1	0	14	11					8		8	8	0	0	0	0	0	0	0	0	0	0	0	0	1	0
1	1	1	1	15	10					7		9	9	0	0	0	0	0	0	0	0	0	0	0	0	0	1

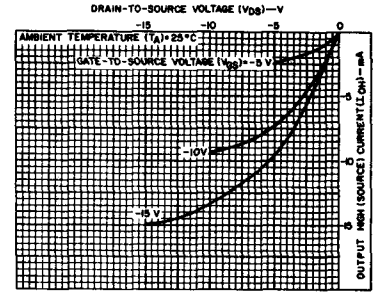

Fig. 6 — Minimum output high (source) current characteristics.

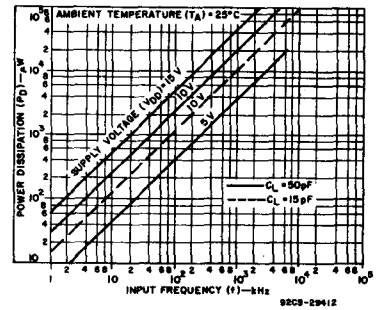

Fig. 7 — Typical dynamic power dissipation as a function of input frequency.

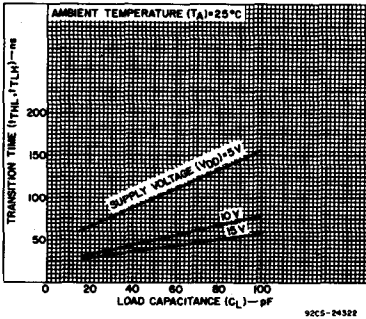

Fig. 8 — Typical transition time as a function of load capacitance.

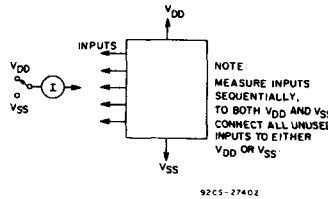

Fig. 9 — Input current test circuit.

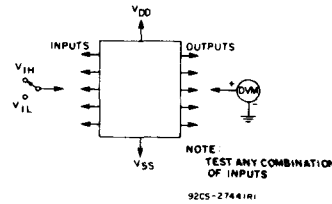

Fig. 11 — Input voltage test circuit.

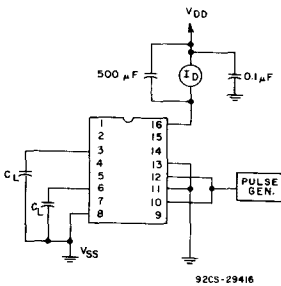

Fig. 10 — Dynamic power dissipation test circuit.

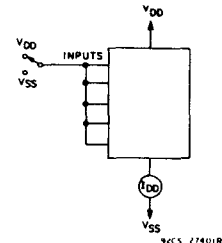

Fig. 12 — Quiescent device current test circuit.

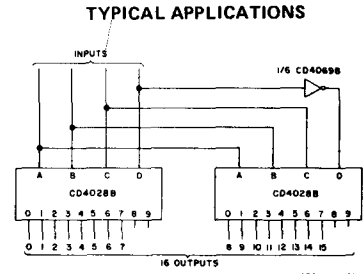
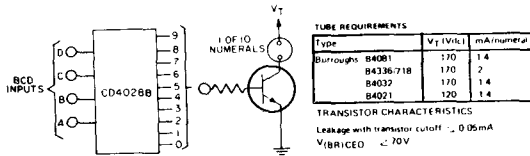

Fig. 13 — Code conversion circuit.

The circuit shown in Fig.13 converts any 4-bit code to a decimal or hexadecimal code. Table 2 shows a number of codes and the decimal or hexadecimal number in these codes which must be applied to the input terminals of the CD4028B to select a particular output. For example: in order to get a high on output No. 8 the input must be either an 8 expressed in 4-Bit Binary code, a 15 expressed in 4-Bit Gray code, or a 5 expressed in Excess-3 code.

# CD4028B Types



▲(Trademark) Burroughs Corp.

92CS-29413

Fig. 14 — Neon readout (Nixie Tube<sup>▲</sup>) display application.

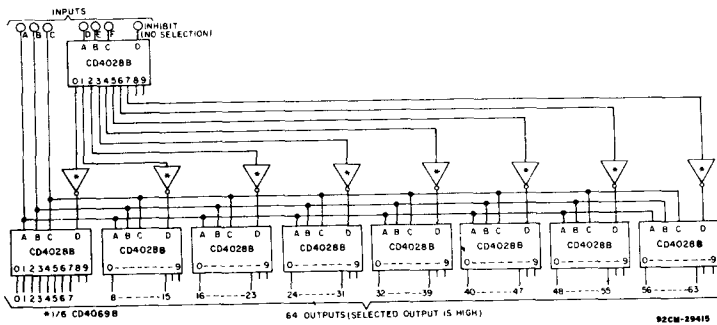
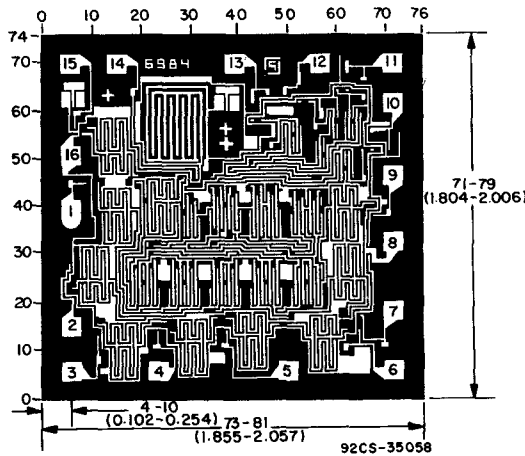

Fig. 15 — 6-bit binary to 1-of-64 address decoder.



## CD4028BH DIMENSIONS AND PAD LAYOUT

Dimensions in parentheses are in millimeters and are derived from the basic inch dimensions as indicated. Grid gradations are in mils ( $10^{-3}$  inch).

The photographs and dimensions of each CMOS chip represent a chip when it is part of the wafer. When the wafer is separated into individual chips, the angle of cleavage may vary with respect to the chip face for different chips. The actual dimensions of the isolated chip, therefore, may differ slightly from the nominal dimensions shown. The user should consider a tolerance of  $-3$  mils to  $+16$  mils applicable to the nominal dimensions shown.

# CD4029B Types

## CMOS Presettable Up/Down Counter

Binary or BCD-Decade

High-Voltage Types (20-Volt Rating)

The RCA-CD4029B consists of a four-stage binary or BCD-decade up/down counter with provisions for look-ahead carry in both counting modes. The inputs consist of a single CLOCK, CARRY-IN (CLOCK ENABLE), BINARY/DECADE, UP/DOWN, PRESET ENABLE, and four individual JAM signals. Q1, Q2, Q3, Q4 and a CARRY OUT signal are provided as outputs.

A high PRESET ENABLE signal allows information on the JAM INPUTS to preset the counter to any state asynchronously with the clock. A low on each JAM line, when the PRESET-ENABLE signal is high, resets the counter to its zero count. The counter is advanced one count at the positive transition of the clock when the CARRY-IN and PRESET ENABLE signals are low. Advancement is inhibited when the CARRY-IN or PRESET ENABLE signals are high. The CARRY-OUT signal is normally high and goes low when the counter reaches its maximum count in the UP mode or the minimum count in the DOWN mode provided the CARRY-IN signal is low. The CARRY-IN signal in the low state can thus be considered a CLOCK ENABLE. The CARRY-IN terminal must be connected to V<sub>SS</sub> when not in use.

Binary counting is accomplished when the BINARY/DECADE input is high; the counter counts in the decade mode when the BINARY/DECADE input is low. The counter counts up when the UP/DOWN input is high, and down when the UP/DOWN input is low. Multiple packages can be connected in either a parallel-clocking or a ripple-clocking arrangement as shown in Fig. 17.

Parallel clocking provides synchronous control and hence faster response from all counting outputs. Ripple-clocking allows for longer clock input rise and fall times.

The CD4029B-series types are supplied in 16-lead ceramic dual-in-line plastic packages (E suffix), 16-lead ceramic flat packages (K suffix), and in chip form (H suffix).

CD4029B Terminal Diagram

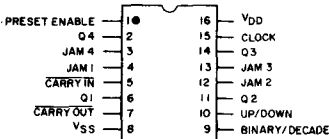

92CS-24472R1

### Features:

- Medium-speed operation . . . 8 MHz (typ.) @ C<sub>L</sub> = 50 pF and V<sub>DD</sub>-V<sub>SS</sub> = 10 V
- Multi-package parallel clocking for synchronous high speed output response or ripple clocking for slow clock input rise and fall times
- "Preset Enable" and individual "Jam" inputs provided
- Binary or decade up/down counting
- BCD outputs in decade mode
- 100% tested for quiescent current at 20 V
- 5-V, 10-V, and 15-V parametric ratings
- Standardized, symmetrical output characteristics
- Maximum input current of 1 μA at 18 V over full package-temperature range; 100 nA at 18 V and 25°C
- Noise margin (over full package-temperature range)
  - 1 V at V<sub>DD</sub> = 5 V
  - 2 V at V<sub>DD</sub> = 10 V
  - 2.5 V at V<sub>DD</sub> = 15 V
- Meets all requirements of JEDEC Tentative Standard No. 13A, "Standard Specifications for Description of 'B' Series CMOS Devices"

### Applications:

- Programmable binary and decade counting/frequency synthesizers-BCD output
- Analog to digital and digital to analog conversion
- Up/Down binary counting
- Magnitude and sign generation
- Up/Down decade counting
- Difference counting

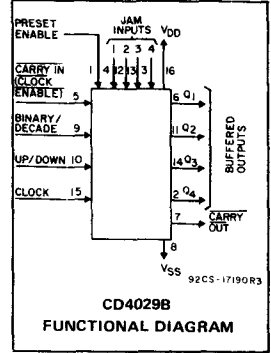

**RECOMMENDED OPERATING CONDITIONS** at T<sub>A</sub> = 25°C, Except as Noted. For maximum reliability, nominal operating conditions should be selected so that operation is always within the following ranges:

CHARACTERISTIC	V <sub>DD</sub> (V)	LIMITS		UNITS
		Min.	Max.	
Supply-Voltage Range (For T <sub>A</sub> = Full Package-Temperature Range)	-	3	18	V
Setup Time t <sub>SU</sub> : Carry-In	5	60	-	
	10	20	-	
	15	12	-	
U/D or B/D	5	340	-	ns
	10	140	-	
	15	100	-	
Clock Pulse Width, t <sub>W</sub>	5	180	-	
	10	90	-	
	15	60	-	
Preset Enable Pulse Width, t <sub>W</sub>	5	130	-	
	10	70	-	
	15	50	-	
Clock Input Frequency, f <sub>CL</sub>	5	-	2	MHz
	10	-	4	
	15	-	5.5	
Clock Rise and Fall Time, t <sub>rCL</sub> , t <sub>fCL</sub>	5	-	-	μs
	10	-	15	
	15	-	-	

# CD4029B Types

## MAXIMUM RATINGS, Absolute-Maximum Values:

DC SUPPLY-VOLTAGE RANGE, ( $V_{DD}$ )	(Voltages referenced to $V_{SS}$ Terminal)	-0.5 to +20 V
INPUT VOLTAGE RANGE, ALL INPUTS		-0.5 to $V_{DD} + 0.5$ V
DC INPUT CURRENT, ANY ONE INPUT		$\pm 10$ mA
POWER DISSIPATION PER PACKAGE ( $P_D$ ):		
For $T_A = -40$ to $+60^\circ\text{C}$ (PACKAGE TYPE E)		500 mW
For $T_A = +60$ to $+85^\circ\text{C}$ (PACKAGE TYPE E)		Derate Linearly at 12 mW/ $^\circ\text{C}$ to 200 mW
For $T_A = -55$ to $+100^\circ\text{C}$ (PACKAGE TYPES D, F, K)		500 mW
For $T_A = +100$ to $+125^\circ\text{C}$ (PACKAGE TYPES D, F, K)		Derate Linearly at 12 mW/ $^\circ\text{C}$ to 200 mW
DEVICE DISSIPATION PER OUTPUT TRANSISTOR		
For $T_A = \text{FULL PACKAGE-TEMPERATURE RANGE (All Package Types)}$		100 mW
OPERATING-TEMPERATURE RANGE ( $T_A$ ):		
PACKAGE TYPES D, F, K, H		-55 to $+125^\circ\text{C}$
PACKAGE TYPE E		-40 to $+85^\circ\text{C}$
STORAGE TEMPERATURE RANGE ( $T_{stg}$ )		-65 to $+150^\circ\text{C}$
LEAD TEMPERATURE (DURING SOLDERING):		$+265^\circ\text{C}$
At distance 1/16 $\pm$ 1/32 inch (1.59 $\pm$ 0.79 mm) from case for 10 s max.		

## STATIC ELECTRICAL CHARACTERISTICS

CHARACTERISTIC	CONDITIONS			LIMITS AT INDICATED TEMPERATURES ( $^\circ\text{C}$ )							UNITS
				Values at -55, +25, +125 Apply to D, F, K, H Packages Values at -40, +25, +85 Apply to E Package							
				-55	-40	+85	+125	+25			
$V_O$ (V)	$V_{IN}$ (V)	$V_{DD}$ (V)					Min.	Typ.	Max.		
Quiescent Device Current, $I_{DD}$ Max.	-	0.5	5	5	5	150	150	-	0.04	5	$\mu\text{A}$
	-	0.10	10	10	10	300	300	-	0.04	10	
	-	0.15	15	20	20	600	600	-	0.04	20	
	-	0.20	20	100	100	3000	3000	-	0.08	100	
Output Low (Sink) Current $I_{OL}$ Min.	0.4	0.5	5	0.64	0.61	0.42	0.36	0.51	1	-	mA
	0.5	0.10	10	1.6	1.5	1.1	0.9	1.3	2.6	-	
	1.5	0.15	15	4.2	4	2.8	2.4	3.4	6.8	-	
Output High (Source) Current, $I_{OH}$ Min.	4.6	0.5	5	-0.64	-0.61	-0.42	-0.36	-0.51	-1	-	mA
	2.5	0.5	5	-2	-1.8	-1.3	-1.15	-1.6	-3.2	-	
	9.5	0.10	10	-1.6	-1.5	-1.1	-0.9	-1.3	-2.6	-	
	13.5	0.15	15	-4.2	-4	-2.8	-2.4	-3.4	-6.8	-	
Output Voltage: Low-Level, $V_{OL}$ Max.	-	0.5	5	0.05			-	0	0.05	-	V
	-	0.10	10	0.05			-	0	0.05	-	
	-	0.15	15	0.05			-	0	0.05	-	
Output Voltage: High-Level, $V_{OH}$ Min.	-	0.5	5	4.95			4.95	5	-	-	V
	-	0.10	10	9.95			9.95	10	-	-	
	-	0.15	15	14.95			14.95	15	-	-	
Input Low Voltage $V_{IL}$ Max.	0.5, 4.5	-	5	1.5			-	-	1.5	-	V
	1.9	-	10	3			-	-	3	-	
	1.5, 13.5	-	15	4			-	-	4	-	
Input High Voltage, $V_{IH}$ Min.	0.5, 4.5	-	5	3.5			3.5	-	-	-	V
	1.9	-	10	7			7	-	-	-	
	1.5, 13.5	-	15	11			11	-	-	-	
Input Current $I_{IN}$ Max.	-	0.18	18	$\pm 0.1$	$\pm 0.1$	$\pm 1$	$\pm 1$	-	$\pm 10^{-5}$	$\pm 0.1$	$\mu\text{A}$

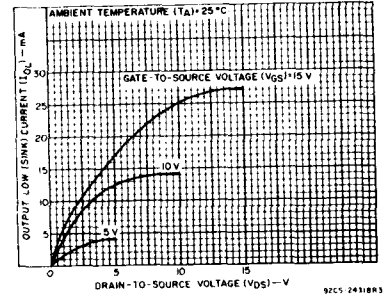

Fig. 1 - Typical output low (sink) current characteristics.

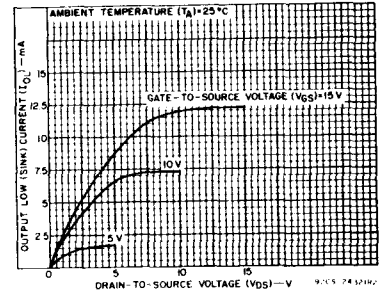

Fig. 2 - Minimum output low (sink) current characteristics.

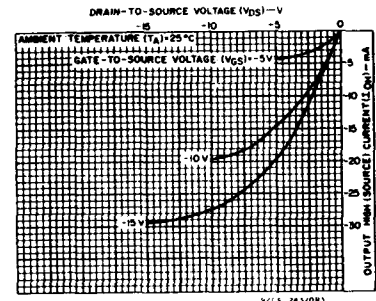

Fig. 3 - Typical output high (source) current characteristics.

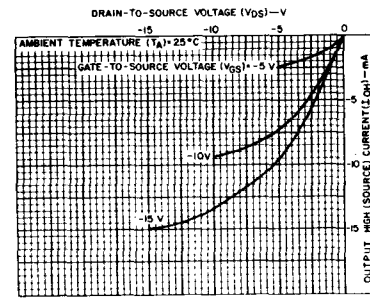

Fig. 4 - Minimum output high (source) current characteristics.

# CD4029B Types

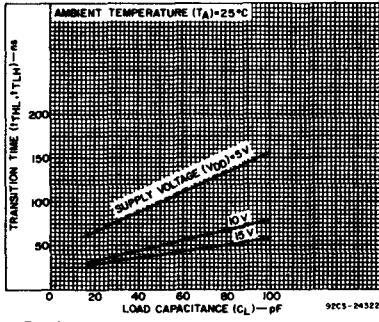

Fig. 5 - Typical transition time as a function of load capacitance.

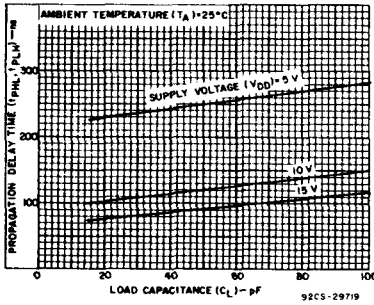

Fig. 6 - Typical propagation delay times as a function of load capacitance (Q output).

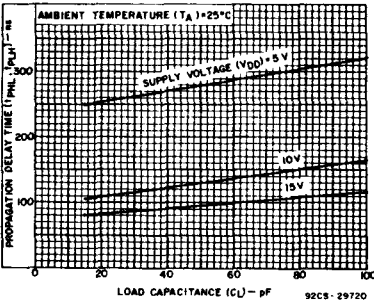

Fig. 7 - Typical propagation delay time as a function of load capacitance (carry output).

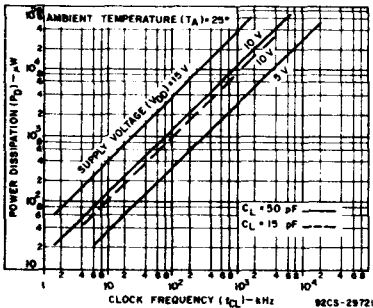
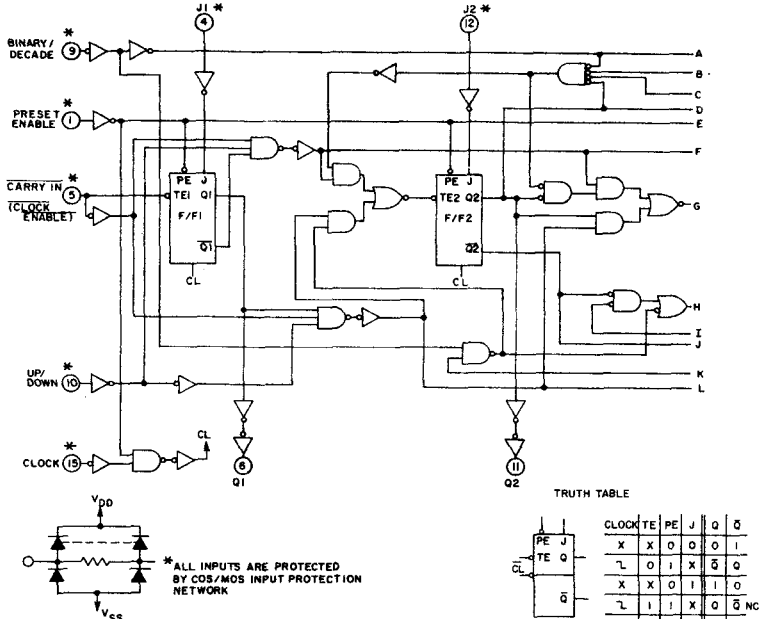

Fig. 8 - Typical power dissipation as a function of frequency.



92CL-28675 R1  
Fig. 9 - Logic diagram.

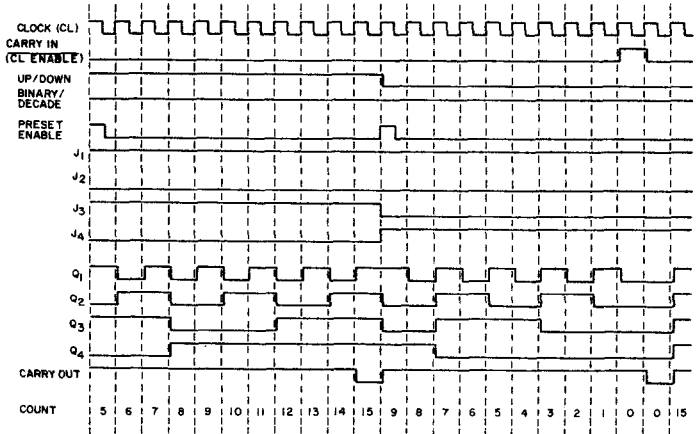
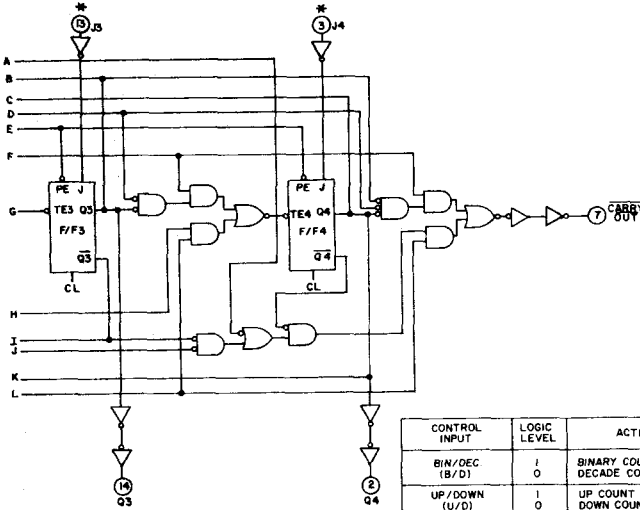

Fig. 10 - Timing diagram-binary mode.

92CM-17192R2



# CD4029B Types



CONTROL INPUT	LOGIC LEVEL	ACTION
BIN/DEC (B/D)	0	BINARY COUNT DECADE COUNT
UP/DOWN (U/D)	1	UP COUNT DOWN COUNT
PRESET ENABLE (PE)	1	JAM IN NO JAM
CARRY IN (CT) (CLOCK ENABLE)	1	NO COUNTER ADVANCE AT POS. CLOCK TRANSITION
	0	ADVANCE COUNTER AT POS. CLOCK TRANSITION

92CL-28675R1

Fig. 9 - Logic diagram (cont'd).

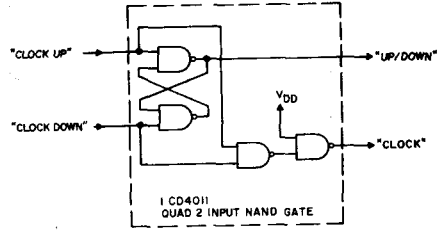

92CS-17195R2

Fig. 11 - Conversion of clock up, clock down input signals to clock and up/down input signals.

The CD4029B CLOCK and UP/DOWN inputs are used directly in most applications. In applications where CLOCK UP and CLOCK DOWN inputs are provided, conversion to the CD4029B CLOCK and UP/DOWN inputs can easily be realized by use of the circuit in Fig. 11.

CD4029B changes count on positive transitions of CLOCK UP or CLOCK DOWN inputs. For the gate configuration shown below, when counting up the CLOCK DOWN input must be maintained high and conversely when counting down the CLOCK UP input must be maintained high.

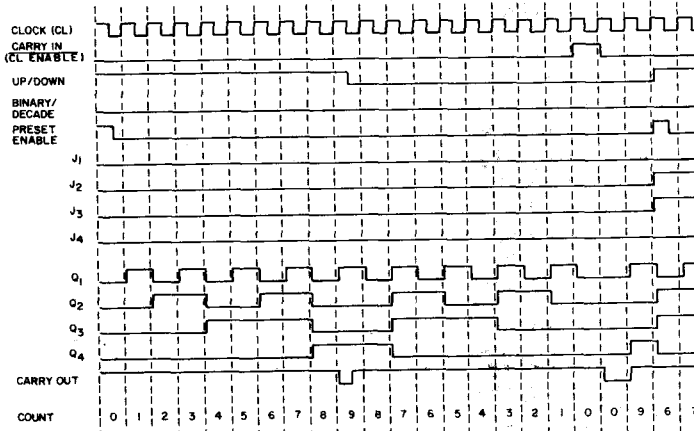

92CM-171935R3

Fig. 12 - Timing diagram-decade mode.

# CD4029B Types

DYNAMIC ELECTRICAL CHARACTERISTICS at  $T_A = 25^\circ\text{C}$ , Input  $t_r, t_f = 20\text{ ns}$ ,  $C_L = 50\text{ pF}$ ,  $R_L = 200\text{ k}\Omega$

CHARACTERISTIC	TEST CONDITIONS	LIMITS			UNITS	
		$V_{DD}$ (V)	Min.	Typ.		Max.
<b>Clocked Operation</b>						
Propagation Delay Time: $t_{PHL}, t_{PLH}$ Q Output		5	—	250	500	ns
		10	—	120	240	
		15	—	90	180	
Carry Output		5	—	280	560	
		10	—	130	260	
		15	—	95	190	
Transition Time: Q Outputs, Carry Output		5	—	100	200	
		10	—	50	100	
		15	—	40	80	
Minimum Clock Pulse Width, $t_W$		5	—	90	180	
		10	—	45	90	
		15	—	30	60	
Clock Rise & Fall Time, $t_{rCL}, t_{fCL}^{**}$		5	—	—	15	$\mu\text{s}$
		10	—	—	15	
		15	—	—	15	
Minimum Setup Times, B/D or U/D		5	—	170	340	ns
		10	—	70	140	
		15	—	50	100	
Maximum Clock Input Frequency, $f_{CL}$		5	2	4	—	MHz
		10	4	8	—	
		15	5.5	11	—	
Input Capacitance, $C_{IN}$	Any Input		—	5	7.5	pF
<b>Preset Enable</b>						
Propagation Delay Time: $t_{PHL}, t_{PLH}$ Q Outputs		5	—	235	470	ns
		10	—	100	200	
		15	—	80	160	
Carry Output		5	—	320	640	
		10	—	145	290	
		15	—	105	210	
Minimum Preset Enable Pulse Width, $t_W$		5	—	65	130	
		10	—	35	70	
		15	—	25	50	
Minimum Preset Enable Removal Time, $t_{rem}^*$		5	—	100	200	
		10	—	55	110	
		15	—	40	80	
<b>Carry Input</b>						
Propagation Delay Time: $t_{PHL}, t_{PLH}$ Carry Output		5	—	170	340	ns
		10	—	70	140	
		15	—	50	100	
Min. HOLD Time $t_H^{***}$ Carry In		5	—	25	50	ns
		10	—	15	30	
		15	—	12	25	
Min Set-Up Time $t_s^{***}$ Carry In		5	—	100	200	ns
		10	—	35	70	
		15	—	30	60	

\* From Up/Down, Binary/Decode, Carry In, or Preset Enable Control Inputs to Clock Edge.  
 \*\* If more than one unit is cascaded in the parallel clocked application,  $t_{rCL}$  should be made less than or equal to the sum of the fixed propagation delay at 15 pF and the transition time of the carry output driving stage for the estimated capacitive load. This measurement was made with a decoupling capacitor ( $>1\text{ }\mu\text{F}$ ) between  $V_{DD}$  and  $V_{SS}$ .  
 \*\*\* From Carry In to Clock Edge

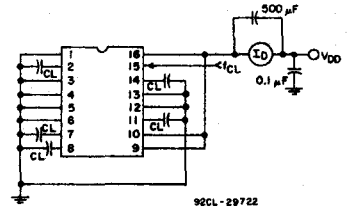

Fig. 13 - Power dissipation test circuit.

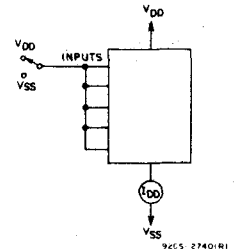

Fig. 14 - Quiescent device current test circuit.

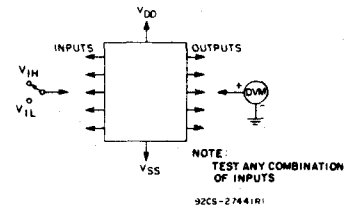

Fig. 15 - Input voltage test circuit.

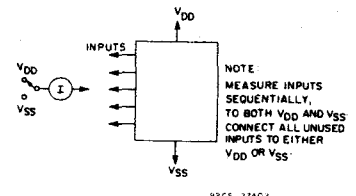
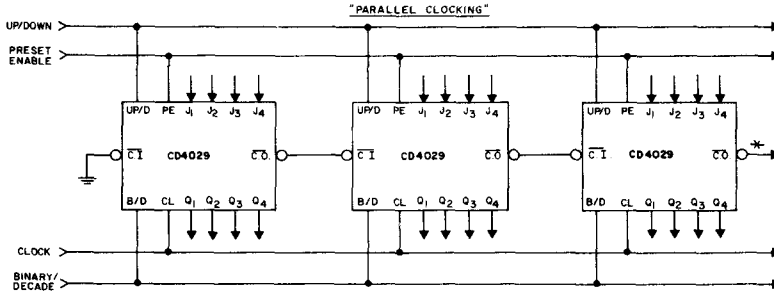
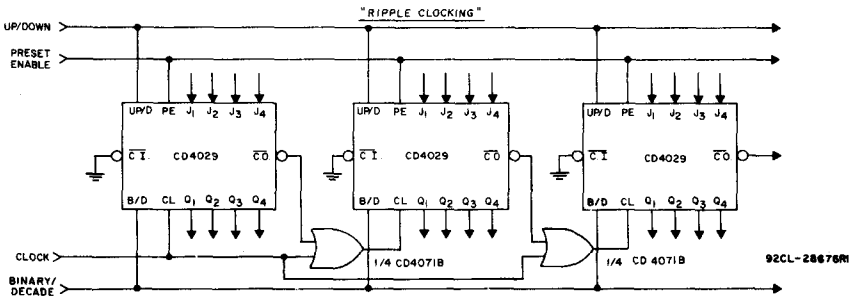

Fig. 16 - Input current test circuit.

# CD4029B Types



\* CARRY OUT lines at the 2nd, 3rd, etc., stages may have a negative-going glitch resulting from differential delays of different CD4029B IC's. These negative-going glitches do not affect proper CD4029B operation. However, if the CARRY OUT signals are used to trigger other edge-sensitive logic devices, such as FF's or counters, the CARRY OUT signals should be gated with the clock signal using a 2-input OR gate such as CD4071B.



### Ripple Clocking Mode:

The Up/Down control can be changed at any count. The only restriction on changing the Up/Down control is that the clock input to the first counting stage must be high. For cascading counters operating in a fixed up-count or down-count mode, the OR gates are not required between stages, and CO is connected directly to the CL input of the next stage with CI grounded.

Fig. 17 - Cascading counter packages.

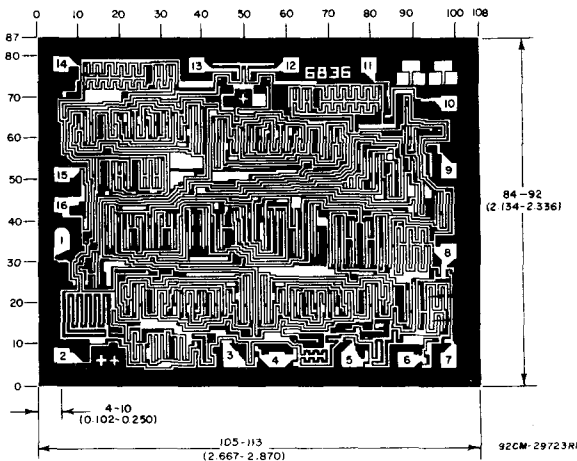

Dimensions and pad layout for CD4029B.

Dimensions in parentheses are in millimeters and are derived from the basic inch dimensions as indicated. Grid graduations are in mils ( $10^{-3}$  inch).

The photographs and dimensions of each CMOS chip represent a chip when it is part of the wafer. When the wafer is separated into individual chips, the angle of cleavage may vary with respect to the chip face for different chips. The actual dimensions of the isolated chip, therefore, may differ slightly from the nominal dimensions shown. The user should consider a tolerance of  $-3$  mils to  $+16$  mils applicable to the nominal dimensions shown.

# CD4030B Types

## CMOS Quad Exclusive-OR Gate

High-Voltage Types (20-Volt Rating)

The RCA-CD4030B types consist of four independent Exclusive-OR gates. The CD4030B provides the system designer with a means for direct implementation of the Exclusive-OR function.

The CD4030B types are supplied in 14-lead hermetic dual-in-line ceramic packages (D and F suffixes), 14-lead dual-in-line plastic packages (E suffix), 14-lead ceramic flat packages (K suffix), and in chip form (H suffix).

### MAXIMUM RATINGS, Absolute-Maximum Values:

DC SUPPLY-VOLTAGE RANGE, (V <sub>DD</sub> )		
(Voltages referenced to V <sub>SS</sub> Terminal)		-0.5 to +20 V
INPUT VOLTAGE RANGE, ALL INPUTS		-0.5 to V <sub>DD</sub> + 0.5 V
DC INPUT CURRENT, ANY ONE INPUT		±10 mA
POWER DISSIPATION PER PACKAGE (P <sub>D</sub> ):		
For T <sub>A</sub> = -40 to +60°C (PACKAGE TYPE E)		500 mW
For T <sub>A</sub> = +60 to +85°C (PACKAGE TYPE E)		Derate Linearly at 12 mW/°C to 200 mW
For T <sub>A</sub> = -55 to +100°C (PACKAGE TYPES D, F, K)		500 mW
For T <sub>A</sub> = +100 to +125°C (PACKAGE TYPES D, F, K)		Derate Linearly at 12 mW/°C to 200 mW
DEVICE DISSIPATION PER OUTPUT TRANSISTOR		
For T <sub>A</sub> = FULL PACKAGE-TEMPERATURE RANGE (All Package Types)		100 mW
OPERATING-TEMPERATURE RANGE (T <sub>A</sub> ):		
PACKAGE TYPES D, F, K, H		-55 to +125°C
PACKAGE TYPE E		-40 to +85°C
STORAGE TEMPERATURE RANGE (T <sub>stg</sub> )		-65 to +150°C
LEAD TEMPERATURE (DURING SOLDERING):		
At distance 1/16 ± 1/32 inch (1.59 ± 0.79 mm) from case for 10 s max.		+265°C

### RECOMMENDED OPERATING CONDITIONS

For maximum reliability, nominal operating conditions should be selected so that operation is always within the following ranges:

CHARACTERISTIC	LIMITS		UNITS
	MIN.	MAX.	
Supply-Voltage Range (For T <sub>A</sub> = Full Package Temperature Range)	3	18	V

### Features:

- Medium-speed operation—t<sub>PHL</sub>, t<sub>PLH</sub> = 65 ns (typ.) at V<sub>DD</sub> = 10 V, C<sub>L</sub> = 50 pF
- 100% tested for quiescent current at 20 V
- Standardized, symmetrical output characteristics
- 5-V, 10-V, and 15-V parametric ratings
- Maximum input current of 1 μA at 18 V over full package-temperature range; 100 nA at 18 V and 25°C
- Noise margin (over full package-temperature range):
  - 1 V at V<sub>DD</sub> = 5 V
  - 2 V at V<sub>DD</sub> = 10 V
  - 2.5 V at V<sub>DD</sub> = 15 V
- Meets all requirements of JEDEC Tentative Standard No. 13A, "Standard Specifications for Description of 'B' Series CMOS Devices"

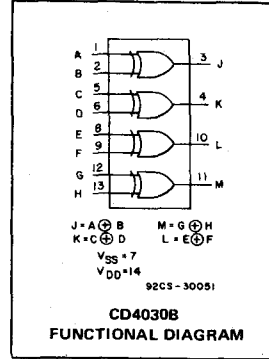

### Applications:

- Even and odd-parity generators and checkers
- Logical comparators
- Adders/subtractors
- General logic functions

### TERMINAL DIAGRAM Top View

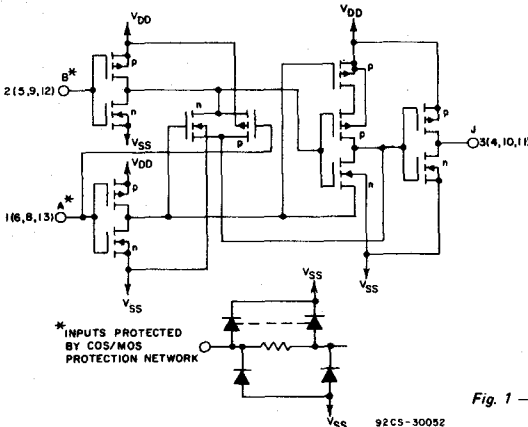
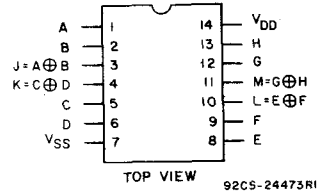

### TRUTH TABLE FOR ONE OF FOUR IDENTICAL GATES

A	B	J
0	0	0
1	0	1
0	1	1
1	1	0

I = HIGH LEVEL  
O = LOW LEVEL

Fig. 1 - Schematic diagram (1 of 4 identical gates).

# CD4030B Types

## STATIC ELECTRICAL CHARACTERISTICS

CHARACTERISTIC	CONDITIONS			LIMITS AT INDICATED TEMPERATURES (°C)							UNITS
	V <sub>O</sub> (V)	V <sub>IN</sub> (V)	V <sub>DD</sub> (V)	Values at -55, +25, +125 Apply to D, F, K, H Packages				Values at -40, +85 Apply to E Package			
				-55	-40	+85	+125	+25			
				Min.	Typ.	Max.					
Quiescent Device Current, I <sub>DD</sub> Max.	-	0,5	5	1	1	30	30	-	0.02	1	μA
	-	0,10	10	2	2	60	60	-	0.02	2	
	-	0,15	15	4	4	120	120	-	0.02	4	
	-	0,20	20	20	20	600	600	-	0.04	20	
Output Low (Sink) Current I <sub>OL</sub> Min.	0.4	0,5	5	0.64	0.61	0.42	0.36	0.51	1	-	mA
	0.5	0,10	10	1.6	1.5	1.1	0.9	1.3	2.6	-	
	1.5	0,15	15	4.2	4	2.8	2.4	3.4	6.8	-	
Output High (Source) Current, I <sub>OH</sub> Min.	4.6	0,5	5	-0.64	-0.61	-0.42	-0.36	-0.51	-1	-	mA
	2.5	0,5	5	-2	-1.8	-1.3	-1.15	-1.6	-3.2	-	
	9.5	0,10	10	-1.6	-1.5	-1.1	-0.9	-1.3	-2.6	-	
	13.5	0,15	15	-4.2	-4	-2.8	-2.4	-3.4	-6.8	-	
Output Voltage: Low-Level, V <sub>OL</sub> Max.	-	0,5	5	0.05				-	0	0.05	V
	-	0,10	10	0.05				-	0	0.05	
	-	0,15	15	0.05				-	0	0.05	
Output Voltage: High-Level, V <sub>OH</sub> Min.	-	0,5	5	4.95				4.95	5	-	V
	-	0,10	10	9.95				9.95	10	-	
	-	0,15	15	14.95				14.95	15	-	
Input Low Voltage, V <sub>IL</sub> Max.	0.5, 4.5	-	5	1.5				-	-	1.5	V
	1, 9	-	10	3				-	-	3	
	1.5, 13.5	-	15	4				-	-	4	
Input High Voltage, V <sub>IH</sub> Min.	0.5, 4.5	-	5	3.5				3.5	-	-	V
	1, 9	-	10	7				7	-	-	
	1.5, 13.5	-	15	11				11	-	-	
Input Current I <sub>IN</sub> Max.	-	0,18	18	±0.1	±0.1	±1	±1	-	±10 <sup>-5</sup>	±0.1	μA

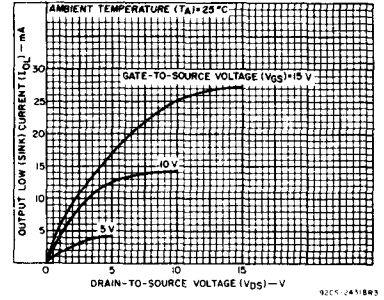

Fig. 2 - Typical output low (sink) current characteristics.

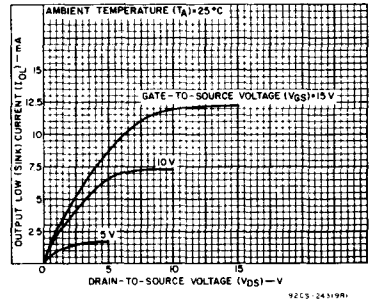

Fig. 3 - Minimum output low (sink) current characteristics.

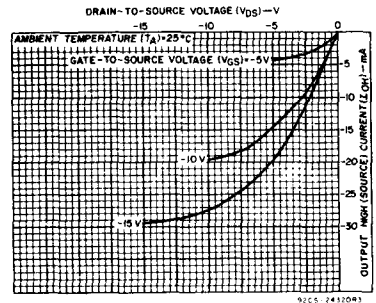

Fig. 4 - Typical output high (source) current characteristics.

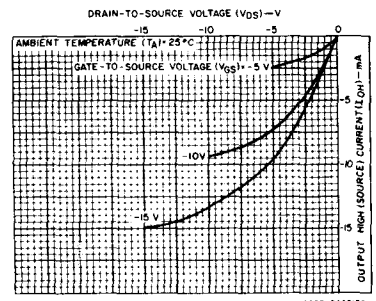

Fig. 5 - Minimum output high (source) current characteristics.

DYNAMIC ELECTRICAL CHARACTERISTICS AT T<sub>A</sub> = 25°C; Input t<sub>r</sub>, t<sub>f</sub> = 20 ns, C<sub>L</sub> = 50 pF, R<sub>L</sub> = 200 KΩ

CHARACTERISTIC	CONDITIONS	LIMITS		UNITS	
		V <sub>DD</sub> (V)	Typ.		Max.
Propagation Delay Time, t <sub>PLH</sub> , t <sub>PHL</sub>	t <sub>PLH</sub> , t <sub>PHL</sub>	5	140	280	ns
		10	65	130	
		15	50	100	
Transition Time, t <sub>THL</sub> , t <sub>TLH</sub>	t <sub>THL</sub> , t <sub>TLH</sub>	5	100	200	ns
		10	50	100	
		15	40	80	
Input Capacitance, C <sub>IN</sub>	Any Input	5	7.5	pF	

# CD4030B Types

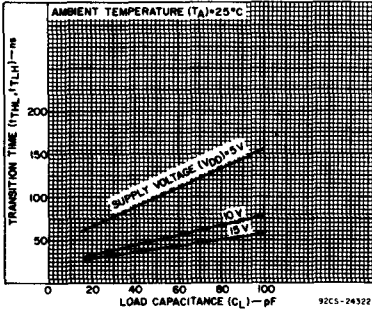

Fig. 6 - Typical transition time as a function of load capacitance.

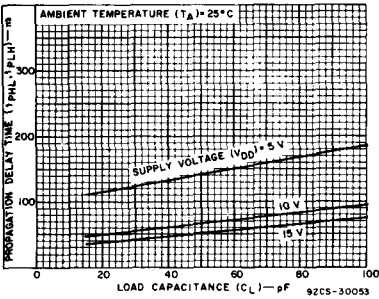

Fig. 7 - Typical propagation delay time as a function of load capacitance.

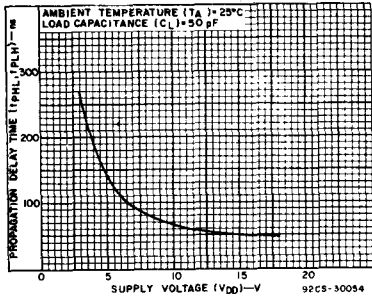

Fig. 8 - Typical propagation delay time as a function of supply voltage.

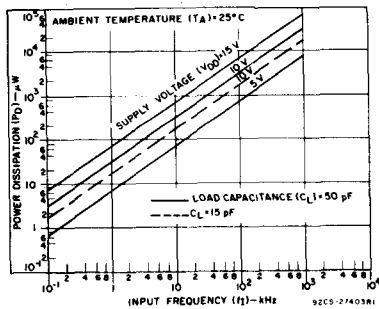

Fig. 9 - Typical dynamic power dissipation as a function of input frequency.

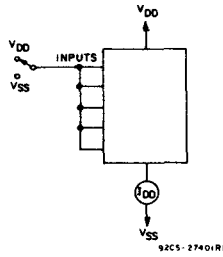

Fig. 10 - Quiescent-device current test circuit.

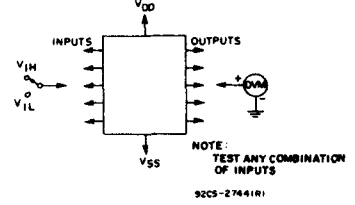

Fig. 11 - Input-voltage test circuit.

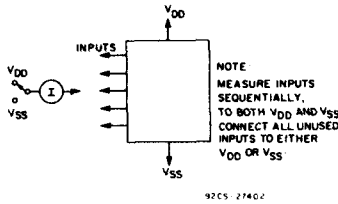

Fig. 12 - Input-current test circuit.

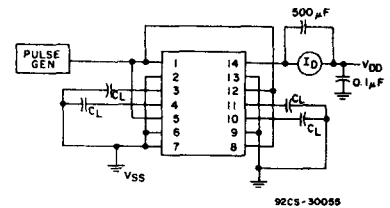
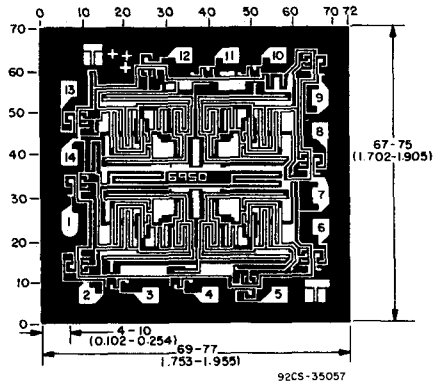

Fig. 13 - Dynamic power dissipation test circuit.



Dimensions and pad layout for CD4030BH.

Dimensions in parentheses are in millimeters and are derived from the basic inch dimensions as indicated. Grid graduations are in mils (10<sup>-3</sup> inch).

The photographs and dimensions of each CMOS chip represent a chip when it is part of the wafer. When the wafer is separated into individual chips, the angle of cleavage may vary with respect to the chip face for different chips. The actual dimensions of the isolated chip, therefore, may differ slightly from the nominal dimensions shown. The user should consider a tolerance of -3 mils to +16 mils applicable to the nominal dimensions shown.

## CMOS 64-Stage Static Shift Register

High-Voltage Types (20-Volt Rating)

The RCA-CD4031B is a static shift register that contains 64 D-type, master-slave flip-flop stages and one stage which is a D-type master flip-flop only (referred to as a 1/2 stage).

The logic level present at the DATA input is transferred into the first stage and shifted one stage at each positive-going clock transition. Maximum clock frequencies up to 12 Megahertz (typical) can be obtained. Because fully static operation is allowed, information can be permanently stored with the clock line in either the low or high state. The CD4031B has a MODE CONTROL input that, when in the high state, allows operation in the recirculating mode. The MODE CONTROL input can also be used to select between two separate data sources. Register packages can be cascaded and the clock lines driven directly for high-speed operation. Alternatively, a delayed clock output (CL<sub>D</sub>) is provided that enables cascading register packages while allowing reduced clock drive fan-out and transition-time requirements. A third cascading option makes use of the Q' output from the 1/2 stage, which is available on the next negative-going transition of the clock after the Q output occurs. This delayed output, like the delayed clock CL<sub>D</sub>, is used with clocks having slow rise and fall times.

The CD4031B types are supplied in 16-lead hermetic dual-in-line ceramic packages (D and F suffixes), 16-lead plastic dual-in-line packages (E suffix), 16-lead ceramic flat packages (K suffix), and in chip form (H suffix).

### Features:

- Fully static operation: DC to 12 MHz typ. @ V<sub>DD</sub>-V<sub>SS</sub> = 15 V
- Standard TTL drive capability on Q output
- Recirculation capability
- Three cascading modes:
  - Direct clocking for high-speed operation
  - Delayed clocking for reduced clock drive requirements
  - Additional 1/2 stage for slow clocks
- 100% tested for quiescent current at 20 V
- Maximum input current of 1 μA at 18 V over full package-temperature range; 100 nA at 18 V and 25°C
- Noise margin (over full package-temperature range)
  - 1 V at V<sub>DD</sub> = 5 V
  - 2 V at V<sub>DD</sub> = 10 V
  - 2.5 V at V<sub>DD</sub> = 15 V

- 5-V, 10-V, and 15-V parametric ratings
- Meets all requirements of JEDEC Tentative Standard No. 13A, "Standard Specifications for Description of 'B' Series CMOS Devices"

### Applications:

- Serial shift registers
- Time delay circuits

### RECOMMENDED OPERATING CONDITIONS

For maximum reliability, nominal operating conditions should be selected so that operation is always within the following ranges:

CHARACTERISTIC	LIMITS		UNITS
	Min.	Max.	
Supply-Voltage Range (For T <sub>A</sub> =Full Package-Temperature Range)	3	18	V

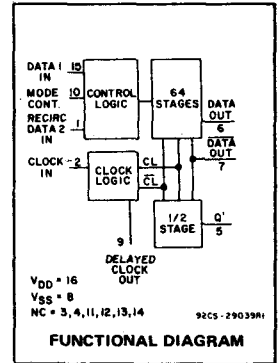

### INPUT CONTROL CIRCUIT TRUTH TABLE

DATA	RECIRC.	MODE	BIT INTO STAGE 1
1	X	0	1
0	X	0	0
X	1	1	1
X	0	1	0

### TYPICAL STAGE TRUTH TABLE

Data	CL	Data + 1
0		0
1		1
X		NC

### TRUTH TABLE FOR OUTPUT FROM Q' (TERMINAL 5)

Data + 64	CL	Data + 64½
0		0
1		1
X		NC

1 = HIGH LEVEL      0 = LOW LEVEL  
X = DON'T CARE      NC = NO CHANGE

### MAXIMUM RATINGS, Absolute-Maximum Values:

DC SUPPLY-VOLTAGE RANGE, (V <sub>DD</sub> ) (Voltages referenced to V <sub>SS</sub> Terminal)	-0.5 to +20 V
INPUT VOLTAGE RANGE, ALL INPUTS	-0.5 to V <sub>DD</sub> +0.5 V
DC INPUT CURRENT, ANY ONE INPUT	±10 mA
POWER DISSIPATION PER PACKAGE (P <sub>D</sub> ):	
For T <sub>A</sub> = -40 to +60°C (PACKAGE TYPE E)	500 mW
For T <sub>A</sub> = +60 to +85°C (PACKAGE TYPE E)	Derate Linearly at 12 mW/°C to 200 mW
For T <sub>A</sub> = -55 to +100°C (PACKAGE TYPES D, F, K)	500 mW
For T <sub>A</sub> = +100 to +125°C (PACKAGE TYPES D, F, K)	Derate Linearly at 12 mW/°C to 200 mW
DEVICE DISSIPATION PER OUTPUT TRANSISTOR	
For T <sub>A</sub> = FULL PACKAGE-TEMPERATURE RANGE (All Package Types)	100 mW
OPERATING-TEMPERATURE RANGE (T <sub>A</sub> ):	
PACKAGE TYPES D, F, K, H	-55 to +125°C
PACKAGE TYPE E	-40 to +85°C
STORAGE TEMPERATURE RANGE (T <sub>stg</sub> )	-65 to +150°C
LEAD TEMPERATURE (DURING SOLDERING):	
At distance 1/16 ± 1/32 inch (1.59 ± 0.79 mm) from case for 10 s max.	+265°C

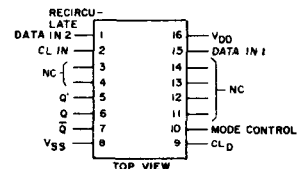

### TERMINAL ASSIGNMENT

# CD4031B Types

## STATIC ELECTRICAL CHARACTERISTICS

CHARACTERISTIC	CONDITIONS			LIMITS AT INDICATED TEMPERATURES (°C)							UNITS
	V <sub>D</sub> (V)	V <sub>IN</sub> (V)	V <sub>DD</sub> (V)	Values at -55, +25, +85, +125 Apply to D, F, K, H Packages				Values at -40, +25, +85, Apply to E Package			
				-55	-40	+85	+125	+25			
				Min.	Typ.	Max.					
Quiescent Device Current, I <sub>DD</sub> Max.	-	0,5	5	5	5	150	150	-	0.04	5	μA
	-	0,10	10	10	10	300	300	-	0.04	10	
	-	0,15	15	20	20	600	600	-	0.04	20	
	-	0,20	20	100	100	3000	3000	-	0.08	100	
Output Low (Sink) Current I <sub>OL</sub> Min.	0,4	0,5	5	2.56	2.44	1.68	1.44	2.04	4	-	mA
	0,5	0,10	10	6.4	6	4.4	3.6	5.2	10.4	-	
	1,5	0,15	15	16.8	16	11.2	9.6	13.6	27.2	-	
	0,4	0,5	5	0.64	0.61	0.42	0.36	0.51	1	-	
Q, Q', CL <sub>D</sub>	0,5	0,10	10	1.6	1.5	1.1	0.9	1.3	2.6	-	mA
	1,5	0,15	15	4.2	4	2.8	2.4	3.4	6.8	-	
	0,5	0,10	10	1.6	1.5	1.1	0.9	1.3	2.6	-	
Output High (Source) Current, I <sub>OH</sub> Min.	4,6	0,5	5	0.64	0.61	-0.42	-0.36	-0.51	-1	-	mA
	2,5	0,5	5	2	1.8	-1.3	-1.15	-1.6	-3.2	-	
	9,5	0,10	10	1.6	-1.5	-1.1	-0.9	-1.3	-2.6	-	
Output Voltage: Low-Level, V <sub>OL</sub> Max.	-	0,5	5	-	-	0.05	-	-	0	0.05	V
	-	0,10	10	-	-	0.05	-	-	0	0.05	
	-	0,15	15	-	-	0.05	-	-	0	0.05	
Output Voltage: High-Level, V <sub>OH</sub> Min.	-	0,5	5	-	-	4.95	-	4.95	5	-	V
	-	0,10	10	-	-	9.95	-	9.95	10	-	
	-	0,15	15	-	-	14.95	-	14.95	15	-	
Input Low Voltage, V <sub>IL</sub> Max.	0,5, 4,5	-	5	-	-	1.5	-	-	-	1.5	V
	1,9	-	10	-	-	3	-	-	-	3	
	1,5, 13,5	-	15	-	-	4	-	-	-	4	
Input High Voltage, V <sub>IH</sub> Min.	0,5, 4,5	-	5	-	-	3.5	-	3.5	-	-	V
	1,9	-	10	-	-	7	-	7	-	-	
	1,5, 13,5	-	15	-	-	11	-	11	-	-	
Input Current I <sub>IN</sub> Max.	-	0,18	18	±0.1	±0.1	±1	±1	-	±10 <sup>-5</sup>	±0.1	μA
	-	-	-	-	-	-	-	-	-	-	

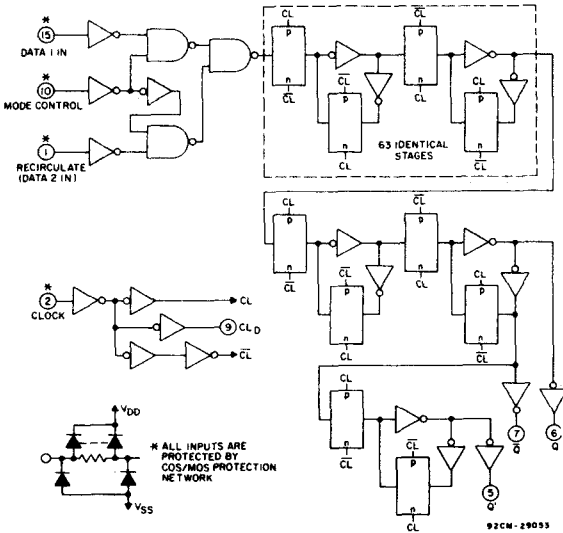

Fig. 1 - Logic diagram.

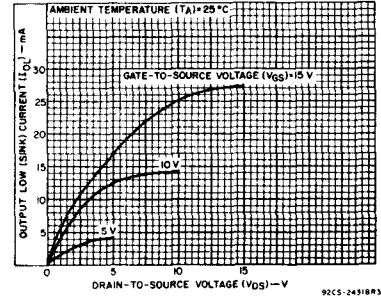

Fig. 2 - Typical output low (sink) current characteristics (Q sink current = 4X ordinate).

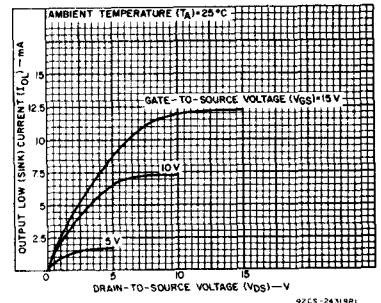

Fig. 3 - Minimum output low (sink) current characteristics (Q sink current = 4X ordinate).

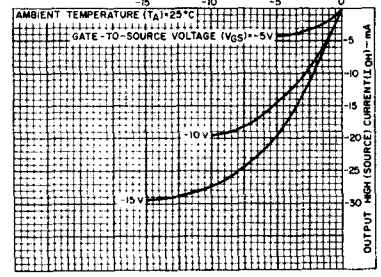

Fig. 4 - Typical output high (source) current characteristics.

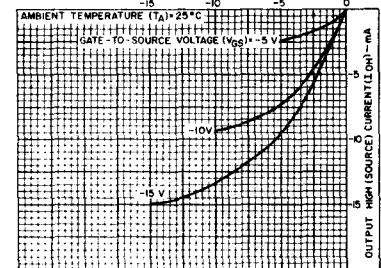

Fig. 5 - Minimum output high (source) current characteristics.



# CD4031B Types

**DYNAMIC ELECTRICAL CHARACTERISTICS** at  $T_A = 25^\circ\text{C}$ ; Input  $t_r, t_f = 20\text{ ns}$ ,  
 $C_L = 50\text{ pF}$ ,  $R_L = 200\text{ k}\Omega$

CHARACTERISTIC	TEST CONDITIONS	LIMITS			UNITS
	$V_{DD}$ (V)	Min.	Typ.	Max.	
Propagation Delay Time: Clock to $\bar{Q}$ , $t_{PHL}$ , $t_{PLH}$ ; Clock to Q, $t_{PLH}$	5	—	250	500	ns
	10	—	110	220	
	15	—	90	180	
Clock to $Q'$ , $t_{PHL}$ , $t_{PLH}$ ; Clock to Q, $t_{PHL}$	5	—	190	380	ns
	10	—	80	160	
	15	—	65	130	
Clock to $CL_D$	5	—	100	200	ns
	10	—	50	100	
	15	—	40	80	
Transition Time, $t_{THL}$ , $t_{TLH}$ (Any Output, except Q, $t_{THL}$ )	5	—	100	200	ns
	10	—	50	100	
	15	—	40	80	
Q, $t_{THL}$	5	—	50	100	ns
	10	—	25	50	
	15	—	20	40	
Minimum Data Setup Time, $t_S$	5	—	30	60	ns
	10	—	15	30	
	15	—	10	20	
Minimum Data Hold Time, $t_H$	5	—	30	60	ns
	10	—	15	30	
	15	—	10	20	
Minimum Clock Pulse Width, $t_W$	5	—	120	240	ns
	10	—	50	100	
	15	—	40	80	
Maximum Clock Input Frequency, $f_{CL}^{**}$	5	2	4	—	MHz
	10	5	10	—	
	15	6	12	—	
Clock Input Rise or Fall Time, $t_{rCL}$ , $t_{fCL}^*$	5	—	—	1000	$\mu\text{s}$
	10	—	—	1000	
	15	—	—	200	
Input Capacitance, $C_{IN}$ (Any Input)	—	—	5	7.5	pF

\*If more than one unit is cascaded in the parallel clocked application,  $t_{rCL}$  should be made less than or equal to the sum of the propagation delay at 50 pF and the transition time of the output driving stage.

\*\*Maximum Clock Frequency for Cascaded Units;

a) Using Delayed Clock Feature in Recirculation Mode:

$$f_{\max} = \frac{1}{(n-1) CL_D \text{ prop. delay} + Q \text{ prop. delay} + \text{set-up time}}$$

where n = number of packages

b) Not Using Delayed Clock:

$$f_{\max} = \frac{1}{\text{propagation delay} + \text{set-up time}}$$

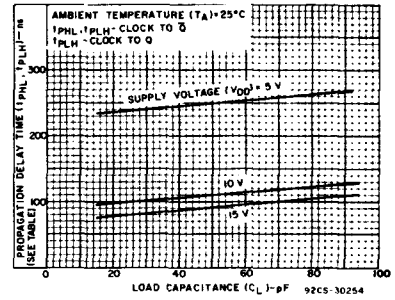

Fig. 6 - Typical propagation delay time as a function of load capacitance (see table).

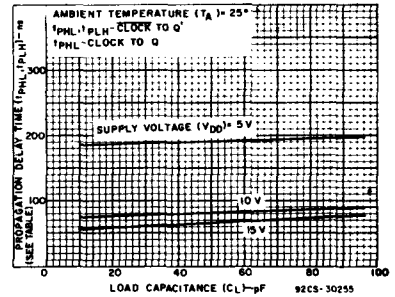

Fig. 7 - Typical propagation delay time as a function of load capacitance (see table).

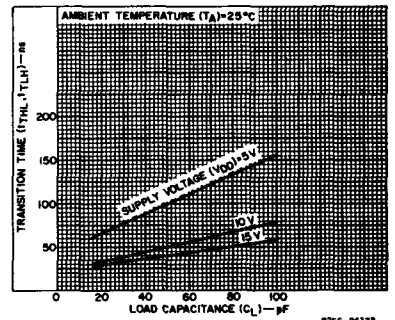

Fig. 8 - Typical transition time as a function of load capacitance (except Q,  $t_{THL}$ ).

# CD4031B Types

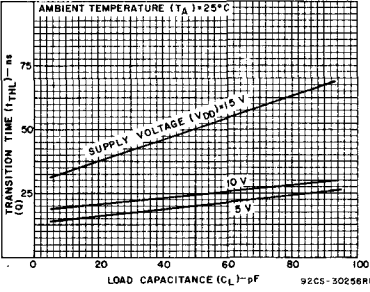

Fig. 9 - Typical transition time as a function of load capacitance (Q, t<sub>THL</sub>).

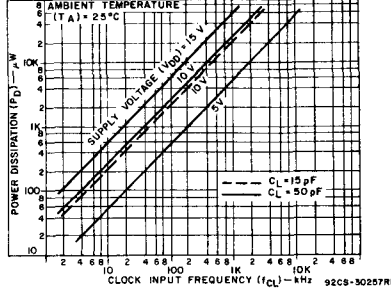

Fig. 10 - Typical dynamic power dissipation as a function of clock input frequency.

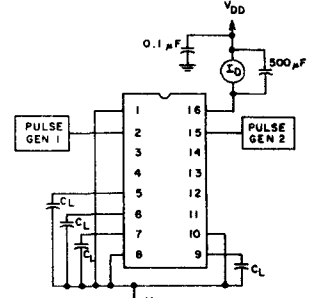

Fig. 11 - Dynamic power dissipation test circuit.

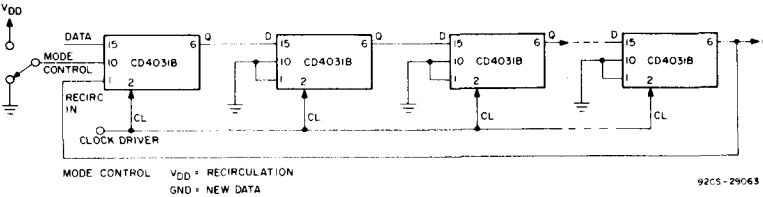

Fig. 12 - Cascading using direct clocking for high-speed operation (see clock rise and fall time requirement).

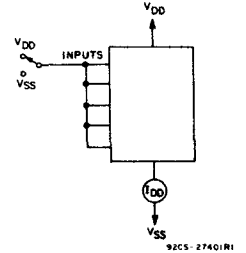

Fig. 13 - Quiescent device current test circuit.

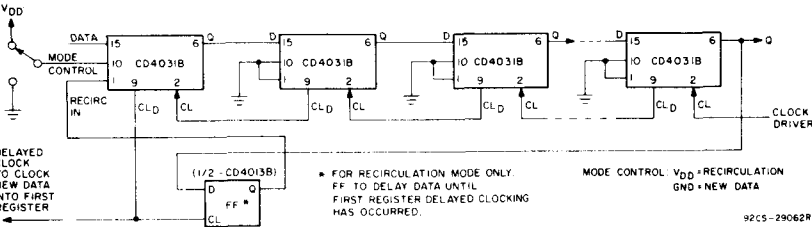

Fig. 14 - Cascading using delayed clocking for reduced clock drive requirements.

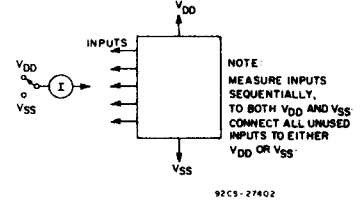

Fig. 15 - Input leakage current.

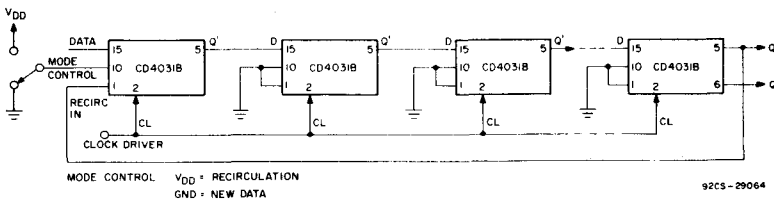

Fig. 16 - Cascading using half-clock-pulse delayed data output (Q') to permit use of slow rise and fall time clock inputs.

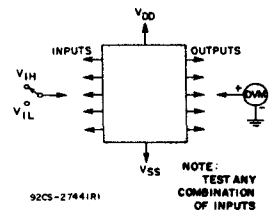
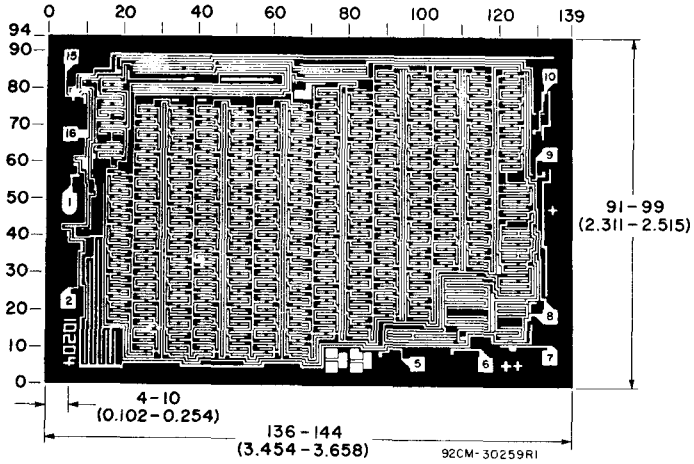

Fig. 17 - Input-voltage test circuit.

## CD4031B Types



### Dimensions and pad layout for CD4031B.

Dimensions in parentheses are in millimeters and are derived from the basic inch dimensions as indicated. Grid graduations are in mils ( $10^{-3}$  inch).

The photographs and dimensions of each CMOS chip represent a chip when it is part of the wafer. When the wafer is separated into individual chips, the angle of cleavage may vary with respect to the chip face for different chips. The actual dimensions of the isolated chip, therefore, may differ slightly from the nominal dimensions shown. The user should consider a tolerance of  $-3$  mils to  $+16$  mils applicable to the nominal dimensions shown.

# CD4032B, CD4038B Types

## CMOS Triple Serial Adders

High-Voltage Types (20-Volt Rating)  
 Positive Logic Adder – CD4032B  
 Negative Logic Adder – CD4038B

The RCA-CD4032B and CD4038B types consist of three serial adder circuits with common CLOCK and CARRY-RESET inputs. Each adder has provisions for two serial DATA INPUT signals and an INVERT command signal. When the command signal is a logical "1", the sum is complemented. Data words enter the adder with the least significant bit first; the sign bit trails. The output is the MOD 2 sum of the input bits plus the carry from the previous bit position. The carry is only added at the positive-going clock transition for the CD4032B or at the negative-going clock for the CD4038B, thus, for spike-free operation the input data transitions should occur as soon as possible after the triggering edge.

The CARRY is reset to a logical "0" at the end of each word by applying a logical "1" signal to a CARRY-RESET input one-bit-position before the application of the first bit of the next word.

The CD4032B and CD4038B types are supplied in 16-lead hermetic dual-in-line ceramic packages (D and F suffixes), 16-lead dual-in-line plastic packages (E suffix), 16-lead ceramic flat packages (K suffix), and in chip form (H suffix).

### Features:

- Invert inputs on all adders for sum complementing applications
- Fully static operation . . . . . dc to 10 MHz (typ.) @  $V_{DD} = 10\text{ V}$
- Single-phase clocking
- Standardized, symmetrical output characteristics
- 100% tested for quiescent current at 20 V
- 5-V, 10-V, and 15-V parametric ratings
- Maximum input current of 1  $\mu\text{A}$  at 18 V over full package-temperature range; 100 nA at 18 V and 25°C
- Noise margin (over full package-temperature range)
  - 1 V at  $V_{DD} = 5\text{ V}$
  - 2 V at  $V_{DD} = 10\text{ V}$
  - 2.5 V at  $V_{DD} = 15\text{ V}$
- Meets all requirements of JEDEC Tentative Standard No. 13A, "Standard Specifications for Description of 'B' Series CMOS Devices"

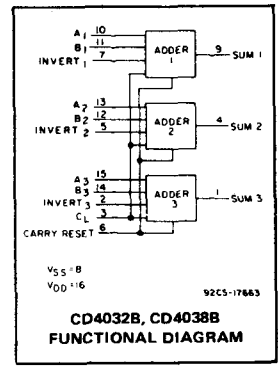

### Applications:

- Serial arithmetic units
- Digital correlators
- Digital datalink computers
- Flight control computers
- Digital servo control systems

### MAXIMUM RATINGS, Absolute-Maximum Values:

DC SUPPLY-VOLTAGE RANGE, ( $V_{DD}$ ) (Voltages referenced to $V_{SS}$ Terminal)	-.5 to +20 V
INPUT VOLTAGE RANGE, ALL INPUTS	-.5 to $V_{DD} + 0.5\text{ V}$
DC INPUT CURRENT, ANY ONE INPUT	$\pm 10\text{ mA}$
POWER DISSIPATION PER PACKAGE ( $P_D$ ):	
For $T_A = -40$ to $+60^\circ\text{C}$ (PACKAGE TYPE E)	500 mW
For $T_A = +60$ to $+85^\circ\text{C}$ (PACKAGE TYPE E)	Derate Linearly at 12 mW/ $^\circ\text{C}$ to 200 mW
For $T_A = -55$ to $+100^\circ\text{C}$ (PACKAGE TYPES D, F, K)	500 mW
For $T_A = +100$ to $+125^\circ\text{C}$ (PACKAGE TYPES D, F, K)	Derate Linearly at 12 mW/ $^\circ\text{C}$ to 200 mW
DEVICE DISSIPATION PER OUTPUT TRANSISTOR	
For $T_A = \text{FULL PACKAGE-TEMPERATURE RANGE (All Package Types)}$	100 mW
OPERATING-TEMPERATURE RANGE ( $T_A$ ):	
PACKAGE TYPES D, F, K, H	$-55$ to $+125^\circ\text{C}$
PACKAGE TYPE E	$-40$ to $+85^\circ\text{C}$
STORAGE TEMPERATURE RANGE ( $T_{stg}$ )	$-65$ to $+150^\circ\text{C}$
LEAD TEMPERATURE (DURING SOLDERING):	
At distance 1/16 $\pm$ 1/32 inch (1.59 $\pm$ 0.79 mm) from case for 10 s max.	$+265^\circ\text{C}$

### CD4032B, CD4038B TERMINAL DIAGRAM

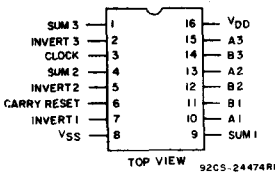

**RECOMMENDED OPERATING CONDITIONS at  $T_A = 25^\circ\text{C}$ , Unless Otherwise Specified**  
 For maximum reliability, nominal operating conditions should be selected so that operation is always within the following ranges.

CHARACTERISTIC	$V_{DD}$	Min.	Max.	UNITS
Supply Voltage Range (at $T_A = \text{Full Package-Temperature Range}$ )		3	18	V
Clock Input Frequency, $f_{CL}$	5	—	2.5	MHz
	10	—	5	
	15	—	7.5	
Clock Input Rise or Fall Time, $t_{rCL}, t_{fCL}$	5	—	500	$\mu\text{s}$
	10	—	500	
	15	—	500	
Data Input Set-Up Time, Clock to A or B Inputs $t_{SU}$	5	200	—	ns
	10	80	—	
	15	60	—	

# CD4032B, CD4038B Types

## STATIC ELECTRICAL CHARACTERISTICS

CHARACTERISTIC	CONDITIONS			LIMITS AT INDICATED TEMPERATURES (°C)								UNIT
				Values at -55, +25, +125 Apply to D, F, K, H, Packages Values at -40, +25, +85 Apply to E Package								
	V <sub>O</sub> (V)	V <sub>IN</sub> (V)	V <sub>DD</sub> (V)	-55	-40	+85	+125	+25				
								Min.	Typ.	Max.		
Quiescent Device Current, I <sub>DD</sub> Max.	-	0,5	5	5	5	150	150	-	0,04	5	μA	
	-	0,10	10	10	10	300	300	-	0,04	10		
	-	0,15	15	20	20	600	600	-	0,04	20		
	-	0,20	20	100	100	3000	3000	-	0,08	100		
Output Low (Sink) Current, I <sub>OL</sub> Min.	0,4	0,5	5	0,64	0,61	0,42	0,36	0,51	1	-	mA	
	0,5	0,10	10	1,6	1,5	1,1	0,9	1,3	2,6	-		
	1,5	0,15	15	4,2	4	2,8	2,4	3,4	6,8	-		
Output High (Source) Current, I <sub>OH</sub> Min.	4,6	0,5	5	-0,64	-0,61	-0,42	-0,36	-0,51	-1	-	mA	
	2,5	0,5	5	-2	-1,8	-1,3	-1,15	-1,6	-3,2	-		
	9,5	0,10	10	-1,6	-1,5	-1,1	-0,9	-1,3	-2,6	-		
	13,5	0,15	15	-4,2	-4	-2,8	-2,4	-3,4	-6,8	-		
Output Voltage: Low-Level, V <sub>OL</sub> Max.	-	0,5	5	0,05				-	0	0,05	V	
	-	0,10	10	0,05				-	0	0,05		
	-	0,15	15	0,05				-	0	0,05		
Output Voltage: High-Level, V <sub>OH</sub> Min.	-	0,5	5	4,95				4,95	5	-	V	
	-	0,10	10	9,95				9,95	10	-		
	-	0,15	15	14,95				14,95	15	-		
Input Low Voltage, V <sub>IL</sub> Max.	0,5, 4,5	-	5	1,5				-	-	1,5	V	
	1,9	-	10	3				-	-	3		
	1,5, 13,5	-	15	4				-	-	4		
Input High Voltage, V <sub>IH</sub> Min.	0,5, 4,5	-	5	3,5				3,5	-	-	V	
	1,9	-	10	7				7	-	-		
	1,5, 13,5	-	15	11				11	-	-		
Input Current I <sub>IN</sub> Max.	-	0,18	18	±0,1	±0,1	±1	±1	-	±10 <sup>-5</sup>	±0,1	μA	

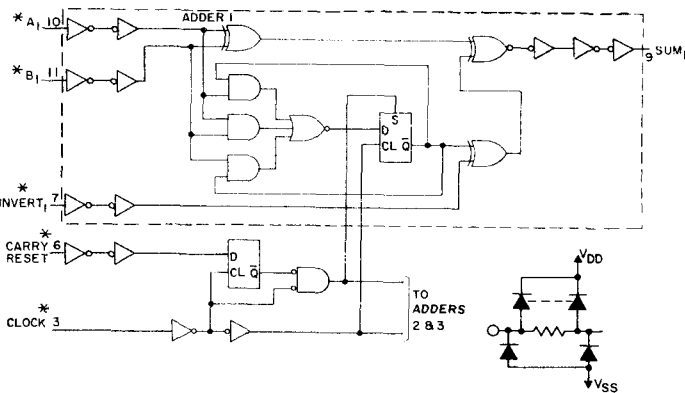

Fig. 1 - CD4032B logic diagram of one of three serial adders.

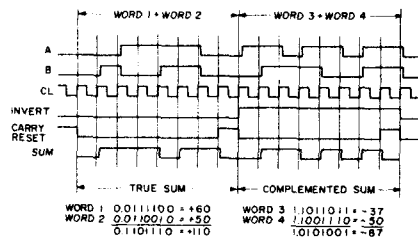

Fig. 2 - CD4032B timing diagram.

\* ALL INPUTS ARE PROTECTED BY COS/MOS PROTECTION NETWORK

92CM-29082R2

# CD4032B, CD4038B Types

DYNAMIC ELECTRICAL CHARACTERISTICS at  $T_A = 25^\circ\text{C}$ , Input  $t_r, t_f = 20\text{ ns}$ ,  $C_L = 50\text{ pF}$ ,  $R_L = 200\text{ k}\Omega$

CHARACTERISTIC	TEST CONDITIONS $V_{DD}(V)$	LIMITS			UNITS
		Min.	Typ.	Max.	
Propagation Delay Time: $t_{PHL}, t_{PLH}$ A,B, Carry Reset, or Invert Inputs to Sum Outputs	5	-	260	520	ns
	10	-	120	240	
	15	-	90	180	
Clock Input to Sum Outputs	5	-	325	650	ns
	10	-	175	350	
	15	-	150	300	
Transition Time: $t_{THL}, t_{TLH}$	5	-	100	200	ns
	10	-	50	100	
	15	-	40	80	
Minimum Data Input Setup Time, $t_{SU}$ Clock to A or B Inputs	5	-	125	200	ns
	10	-	50	80	
	15	-	40	60	
Maximum Clock Input Frequency, $f_{CL}$	5	2.5	4.5	-	MHz
	10	5	10	-	
	15	7.5	15	-	
Clock Input Rise or Fall Time, $t_{rCL}, t_{fCL}^*$	5	-	-	500	$\mu\text{s}$
	10	-	-	500	
	15	-	-	500	
Input Capacitance, $C_{IN}$	(Any Input)	-	5	7.5	pF

\* If more than one unit is cascaded  $t_{rCL}$  should be made less than or equal to the sum of the transition time and the fixed propagation delay of the output of the driving stage for the estimated capacitive load.

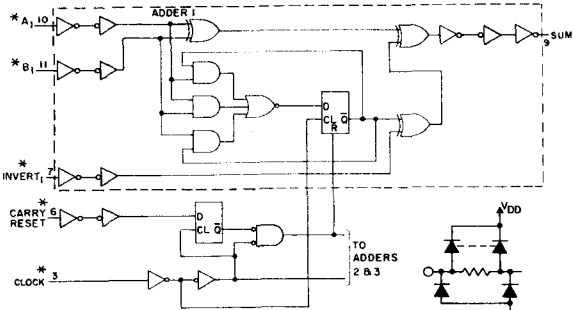

Fig. 3 - CD4038B logic diagram of one of three serial adders.

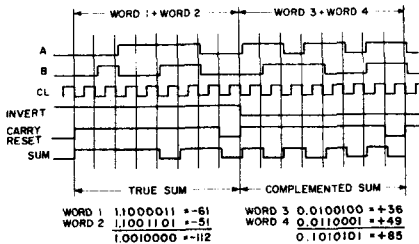

Fig. 4 - CD4038B timing diagram.

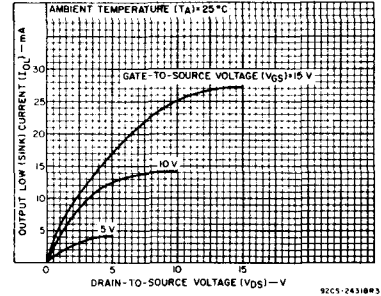

Fig. 5 - Typical output low (sink) current characteristics.

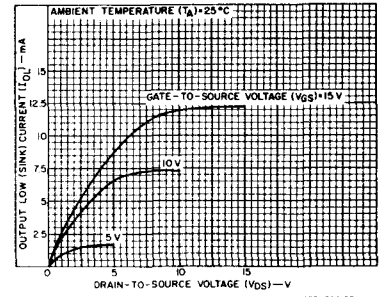

Fig. 6 - Minimum output low (sink) current characteristics.

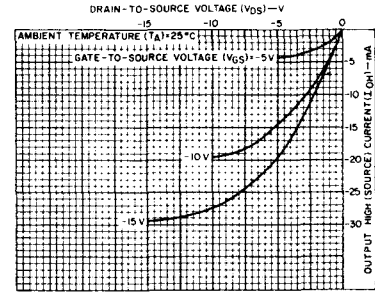

Fig. 7 - Typical output high (source) current characteristics.

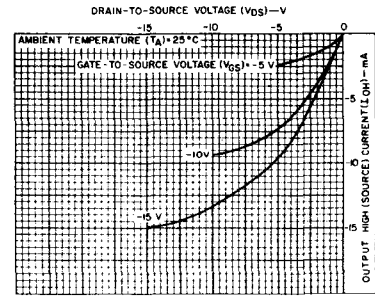

Fig. 8 - Minimum output high (source) current characteristics.

# CD4032B, CD4038B Types

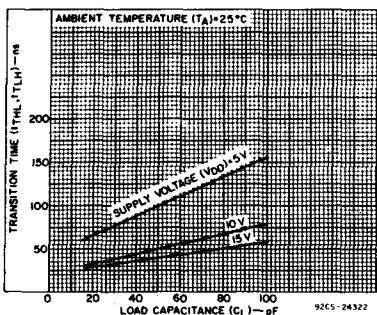

Fig. 9 - Typical transition time as a function of load capacitance.

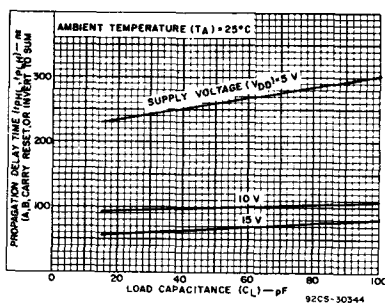

Fig. 10 - Typical propagation delay times as a function of load capacitance (A, B, carry reset or invert to SUM).

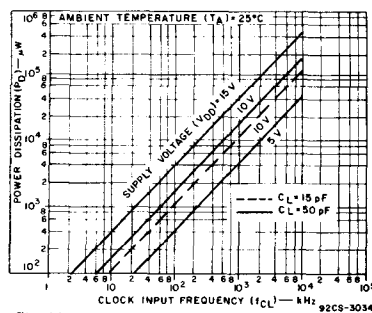

Fig. 11 - Typical dynamic power dissipation as a function of clock input frequency.

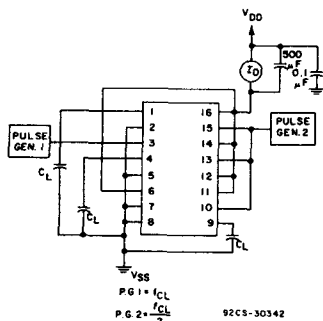

Fig. 12 - Dynamic power dissipation test circuit.

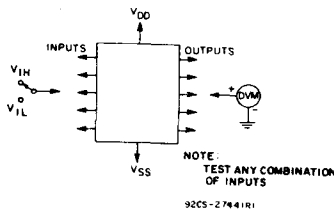

Fig. 13 - Input voltage test circuit.

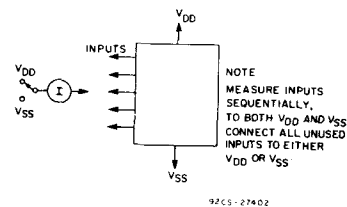

Fig. 14 - Input current test circuit.

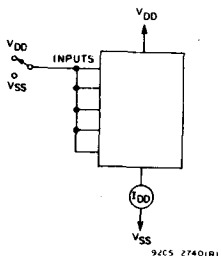
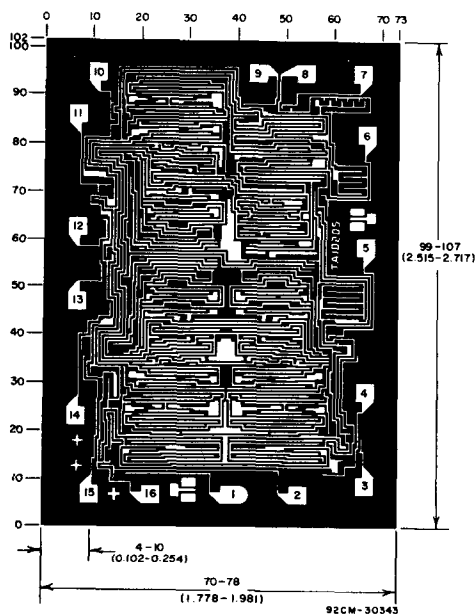

Fig. 15 - Quiescent-device current test circuit.

Dimensions in parentheses are in millimeters and are derived from the basic inch dimensions as indicated. Grid graduations are in mils ( $10^{-3}$  inch).

The photographs and dimensions of each CMOS chip represent a chip when it is part of the wafer. When the wafer is separated into individual chips, the angle of cleavage may vary with respect to the chip face for different chips. The actual dimensions of the isolated chip, therefore, may differ slightly from the nominal dimensions shown. The user should consider a tolerance of  $-3$  mils to  $+16$  mils applicable to the nominal dimensions shown.



Dimensions and pad layout for CD4032BH; dimensions and pad layout for CD4038BH are identical.

# CD4034B Types

## CMOS 8-Stage Static Bidirectional Parallel/Serial Input/Output Bus Register

High-Voltage Types (20-Volt Rating)

The RCA-CD4034B is a static eight-stage parallel-or serial-input parallel-output register. It can be used to:

1) bidirectionally transfer parallel information between two buses, 2) convert serial data to parallel form and direct the parallel data to either of two buses, 3) store (recirculate) parallel data, or 4) accept parallel data from either of two buses and convert that data to serial form. Inputs that control the operations include a single-phase CLOCK (CL), A DATA ENABLE (AE), ASYNCHRONOUS/SYNCHRONOUS (A/S), A-BUS-TO-B-BUS/B-BUS-TO-A-BUS (A/B), and PARALLEL/SERIAL (P/S).

Data inputs include 16 bidirectional parallel data lines of which the eight A data lines are inputs (3-state outputs) and the B data lines are outputs (inputs) depending on the signal level on the A/B input. In addition, an input for SERIAL DATA is also provided.

All register stages are D-type master-slave flip-flops with separate master and slave clock inputs generated internally to allow synchronous or asynchronous data transfer from master to slave. Isolation from external noise and the effects of loading is provided by output buffering.

### PARALLEL OPERATION

A high P/S input signal allows data transfer into the register via the parallel data lines synchronously with the positive transition of the clock provided the A/S input is low. If the A/S input is high the transfer is independent of the clock. The direction of data flow is controlled by the A/B input. When this signal is high the A data lines are inputs (and B data lines are outputs); a low A/B signal reverses the direction of data flow.

The AE input is an additional feature which allows many registers to feed data to a common bus. The A DATA lines are enabled only when this signal is high.

Data storage through recirculation of data in each register stage is accomplished by making the A/B signal high and the AE signal low.

### Applications:

- Parallel Input/Parallel Output, Parallel Input/Serial Output, Serial Input/Parallel Output, Serial Input/Serial Output Register
- Shift right/shift left register
- Shift right/shift left with parallel loading
- Address register
- Buffer register
- Bus system register with enable parallel lines at bus side
- Double bus register system
- Up-Down Johnson or ring counter
- Pseudo-random code generators
- Sample and hold register (storage, counting, display)
- Frequency and phase comparator

### SERIAL OPERATION

A low P/S signal allows serial data to transfer into the register synchronously with the positive transition of the clock. The A/S input is internally disabled when the register is in the serial mode (asynchronous serial operation is not allowed).

The serial data appears as output data on either the B lines (when A/B is high) or the A lines (when A/B is low and the AE signal is high).

Register expansion can be accomplished by simply cascading CD4034B packages.

The CD4034B types are supplied in 24-lead dual-in-line ceramic packages (D and F suffixes), 24-lead dual-in-line plastic packages (E suffix), 24-lead ceramic flat packages (K suffix), and in chip form (H suffix).

### MAXIMUM RATINGS, Absolute-Maximum Values:

DC SUPPLY -VOLTAGE RANGE, (V <sub>DD</sub> )	-0.5 to +20 V
(Voltages referenced to V <sub>SS</sub> Terminal)	
INPUT VOLTAGE RANGE, ALL INPUTS	-0.5 to V <sub>DD</sub> +0.5 V
DC INPUT CURRENT, ANY ONE INPUT	±10 mA
POWER DISSIPATION PER PACKAGE (P <sub>D</sub> ):	
For T <sub>A</sub> = -40 to +60°C (PACKAGE TYPE E)	500 mW
For T <sub>A</sub> = +60 to +85°C (PACKAGE TYPE E)	Derate Linearly at 12 mW/°C to 200 mW
For T <sub>A</sub> = -55 to +100°C (PACKAGE TYPES D, F, K)	500 mW
For T <sub>A</sub> = +100 to +125°C (PACKAGE TYPES D, F, K)	Derate Linearly at 12 mW/°C to 200 mW
DEVICE DISSIPATION PER OUTPUT TRANSISTOR	
For T <sub>A</sub> = FULL PACKAGE-TEMPERATURE RANGE (All Package Types)	100 mW
OPERATING-TEMPERATURE RANGE (T <sub>A</sub> ):	
PACKAGE TYPES D, F, K, H	-55 to +125°C
PACKAGE TYPE E	-40 to +85°C
STORAGE TEMPERATURE RANGE (T <sub>stg</sub> )	-65 to +150°C
LEAD TEMPERATURE (DURING SOLDERING):	
At distance 1/16 ± 1/32 inch (1.59 ± 0.79 mm) from case for 10 s max.	+265°C

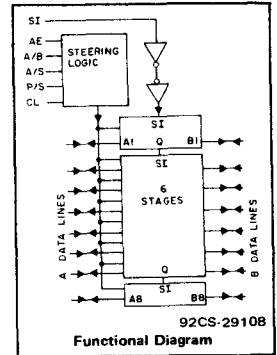

### Features:

- Bidirectional parallel data input
- Parallel or serial inputs/parallel outputs
- Asynchronous or synchronous parallel data loading
- Parallel data-input enable on "A" data lines (3-state output)
- Data recirculation for register expansion
- Multipackage register expansion
- Fully static operation dc-to-10 MHz (typ.) at V<sub>DD</sub> = 10 V
- Standardized, symmetrical output characteristics
- 100% tested for quiescent current at 20 V
- 5-V, 10-V, and 15-V parametric ratings
- Maximum input current of 1 μA at 18 V over full package-temperature range; 100 nA at 18 V and 25°C
- Noise margin (over full package-temperature range):
  - 1 V at V<sub>DD</sub> = 5 V
  - 2 V at V<sub>DD</sub> = 10 V
  - 2.5 V at V<sub>DD</sub> = 15 V
- Meets all requirements of JEDEC Tentative Standard No. 13A, "Standard Specifications for Description of 'B' Series CMOS Devices"





# CD4034B Types

## STATIC ELECTRICAL CHARACTERISTICS

CHARACTERISTIC	CONDITIONS			LIMITS AT INDICATED TEMPERATURES (°C)							UNITS			
				Values at -55, +25, +125 Apply to D, F, K, H Packages								Min.	Typ.	Max.
				Values at -40, +25, +85 Apply to E Package										
$V_O$ (V)	$V_{IN}$ (V)	$V_{DD}$ (V)	-55	-40	+85	+125	+25							
Quiescent Device Current, $I_{DD}$ Max.	-	0,5	5	5	5	150	150	-	0.04	5	$\mu A$			
	-	0,10	10	10	10	300	300	-	0.04	10				
	-	0,15	15	20	20	600	600	-	0.04	20				
	-	0,20	20	100	100	3000	3000	-	0.08	100				
Output Low (Sink) Current $I_{OL}$ Min.	0.4	0,5	5	0.64	0.61	0.42	0.36	0.51	1	-	$mA$			
	0.5	0,10	10	1.6	1.5	1.1	0.9	1.3	2.6	-				
	1.5	0,15	15	4.2	4	2.8	2.4	3.4	6.8	-				
Output High (Source) Current, $I_{OH}$ Min.	4.6	0,5	5	-0.64	-0.61	-0.42	-0.36	-0.51	-1	-	$mA$			
	2.5	0,5	5	-2	-1.8	-1.3	-1.15	-1.6	-3.2	-				
	9.5	0,10	10	-1.6	-1.5	-1.1	-0.9	-1.3	-2.6	-				
	13.5	0,15	15	-4.2	-4	-2.8	-2.4	-3.4	-6.8	-				
Output Voltage: Low-Level, $V_{OL}$ Max.	-	0,5	5	0.05			-	0	0.05	-	V			
	-	0,10	10	0.05			-	0	0.05	-				
	-	0,15	15	0.05			-	0	0.05	-				
Output Voltage: High-Level, $V_{OH}$ Min.	-	0,5	5	4.95			-	4.95	5	-	V			
	-	0,10	10	9.95			-	9.95	10	-				
	-	0,15	15	14.95			-	14.95	15	-				
Input Low Voltage $V_{IL}$ Max.	0.5, 4.5	-	5	1.5			-	-	1.5	-	V			
	1.9	-	10	3			-	-	3	-				
	1.5, 13.5	-	15	4			-	-	4	-				
Input High Voltage, $V_{IH}$ Min.	0.5, 4.5	-	5	3.5			-	3.5	-	-	V			
	1.9	-	10	7			-	7	-	-				
	1.5, 13.5	-	15	11			-	11	-	-				
Input Current* $I_{IN}$ Max.	-	0,18	18	$\pm 0.1$	$\pm 0.1$	$\pm 1$	$\pm 1$	-	$\pm 10^{-5}$	$\pm 0.1$	$\mu A$			
3-State Output Leakage Current $I_{OUT}$ Max.	0,18	0,18	18	$\pm 0.4$	$\pm 0.4$	$\pm 12$	$\pm 12$	-	$\pm 10^{-4}$	$\pm 0.4$	$\mu A$			

\* All inputs except A and B Lines.

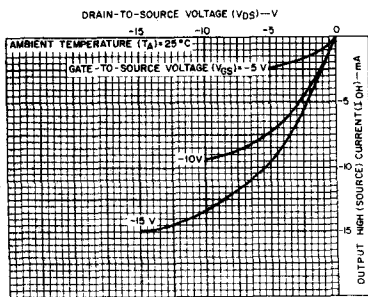

Fig. 8 - Minimum output high (source) current characteristics.

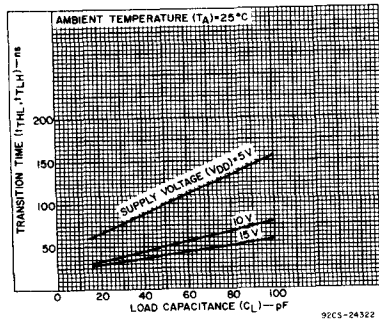

Fig. 9 - Typical transition time as a function of load capacitance.

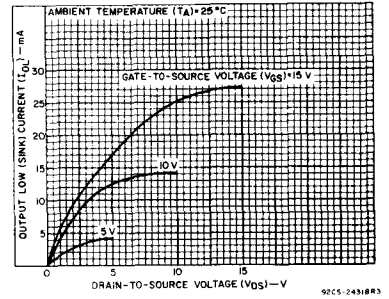

Fig. 5 - Typical output low (sink) current characteristics.

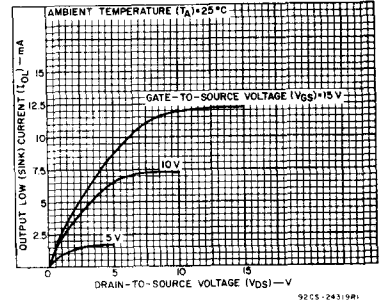

Fig. 6 - Minimum output low (sink) current characteristics.

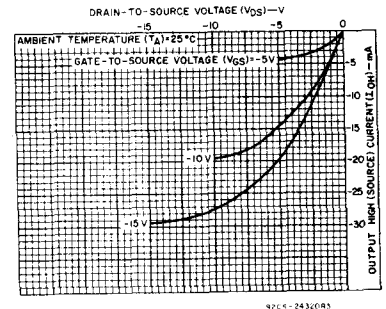

Fig. 7 - Typical output high (source) current characteristics.

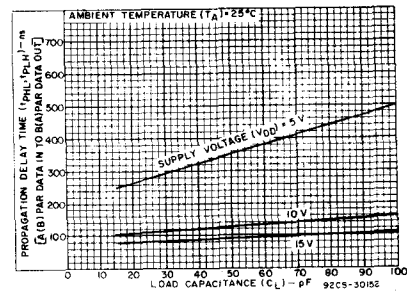

Fig. 10 - Typical propagation delay time as a function of load capacitance [A(B) parallel Data Input to B(A) parallel Data Output, synchronous or asynchronous].

# CD4034B Types

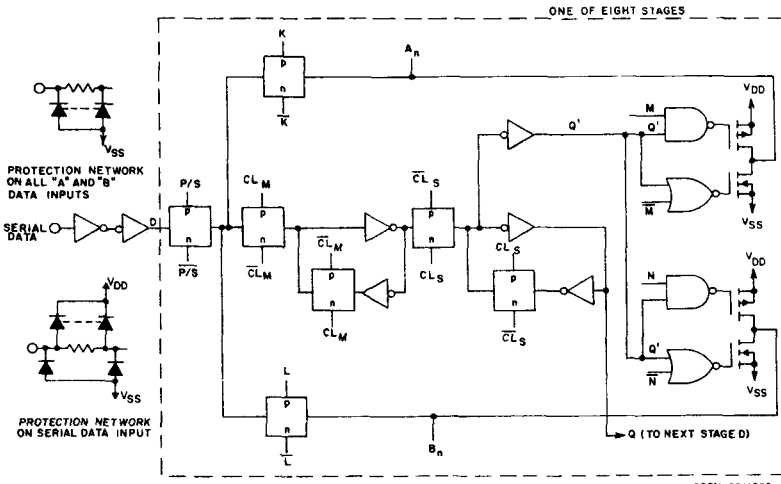

Fig. 11 - Register stage logic diagram (1 of 8 stages).

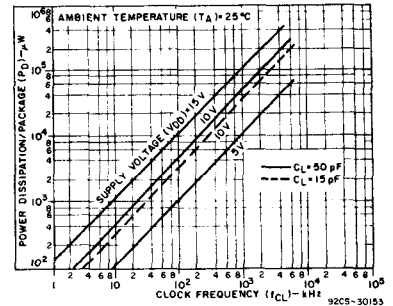

Fig. 12 - Typical dynamic power dissipation as a function of clock frequency.

## TRUTH TABLE FOR REGISTER INPUT-LEVELS AND RESULTING REGISTER OPERATION

"A" Enable	P/S	A/B	A/S	Operation*
0	0	0	X	Serial Mode; Synch. Serial Data Input, "A" Parallel Data Outputs Disabled
0	0	1	X	Serial Mode; Synch. Serial Data Input, "B" Parallel Data Output
0	1	0	0	Parallel Mode; "B" Synch. Parallel Data Inputs, "A" Parallel Data Outputs Disabled
0	1	0	1	Parallel Mode; "B" Asynch. Parallel Data Inputs, "A" Parallel Data Outputs Disabled
0	1	1	0	Parallel Mode; "A" Parallel Data Inputs Disabled, "B" Parallel Data Outputs, Synch. Data Recirculation
0	1	1	1	Parallel Mode; "A" Parallel Data Inputs Disabled, "B" Parallel Data Outputs, Asynch. Data Recirculation
1	0	0	X	Serial Mode; Synch. Serial Data Input, "A" Parallel Data Output
1	0	1	X	Serial Mode; Synch. Serial Data Input, "B" Parallel Data Output
1	1	0	0	Parallel Mode; "B" Synch. Parallel Data Input, "A" Parallel Data Output
1	1	0	1	Parallel Mode; "B" Asynch. Parallel Data Input, "A" Parallel Data Output
1	1	1	0	Parallel Mode; "A" Synch. Parallel Data Input, "B" Parallel Data Output
1	1	1	1	Parallel Mode; "A" Asynch. Parallel Data Input, "B" Parallel Data Output

\*Outputs change at positive transition of clock in the serial mode and when the A/S control input is "low" in the parallel mode. During transfer from parallel to serial operation A/S should remain low in order to prevent D<sub>S</sub> transfer into Flip Flops.

1 = HIGH LEVEL      0 = LOW LEVEL      X = DON'T CARE

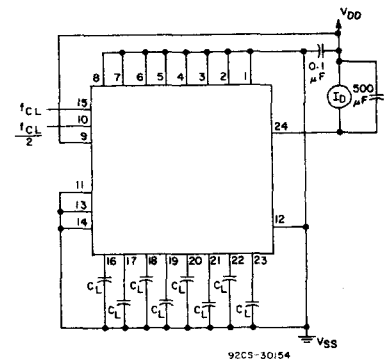

Fig. 13 - Dynamic power dissipation test circuit.

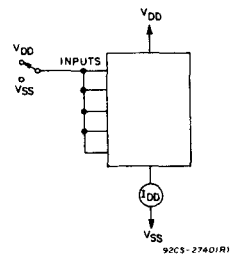

Fig. 14 - Quiescent-device-current test circuit.

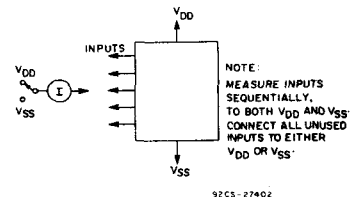

Fig. 15 - Input-current test circuit.

# CD4034B Types

DYNAMIC ELECTRICAL CHARACTERISTICS at  $T_A = 25^\circ\text{C}$ ; Input  $t_r, t_f = 20\text{ ns}$ ,  
 $C_L = 50\text{ pF}$ ,  $R_L = 200\text{ k}\Omega$

CHARACTERISTIC	$V_{DD}$ (V)	LIMITS			UNITS
		Min.	Typ.	Max.	
Propagation Delay Time, A(B) Parallel Data In to B(A) Parallel Data Out Serial to Parallel Data Out	5	—	350	700	ns
	10	—	120	240	
	15	—	85	170	
3-State Propagation Delay Time, A/B or AE to "A" OUT	5	—	200	400	ns
	10	—	80	160	
	15	—	60	120	
Transition Time,	5	—	100	200	ns
	10	—	50	100	
	15	—	40	80	
Minimum Data Setup Time, Serial Data to Clock	5	—	80	160	ns
	10	—	30	60	
	15	—	20	40	
Parallel Data to Clock	5	—	25	50	ns
	10	—	15	30	
	15	—	10	20	
Minimum High-Level Pulse Width, $t_W$ AE, P/S, A/S	5	—	175	350	ns
	10	—	70	140	
	15	—	40	80	
Maximum Clock Frequency, $f_{CL}$	5	2	4	—	MHz
	10	5	10	—	
	15	7	14	—	
Minimum Clock Pulse Width, $t_W$	5	—	125	250	ns
	10	—	50	100	
	15	—	35	70	
Maximum Clock Rise or Fall Time, $t_r, t_f$	5, 10, 15	—	—	15	$\mu\text{s}$
Input Capacitance, (Any Input) $C_{IN}$	—	—	5	7.5	pF

\*If more than one unit is cascaded,  $t_{r,CL}$  should be made less than or equal to the sum of the transition time and the fixed propagation delay of the output of the driving stage for the estimated capacitive load.

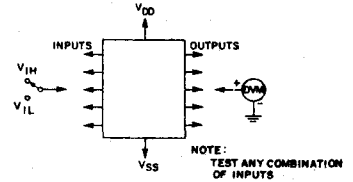

Fig. 16 - Input-voltage test circuit.

## Applications

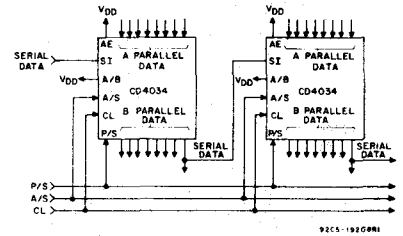

Fig. 17 - 16-bit parallel in/parallel out, parallel in/serial out, serial in/parallel out, serial in/serial out register.

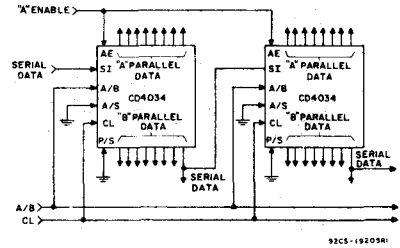
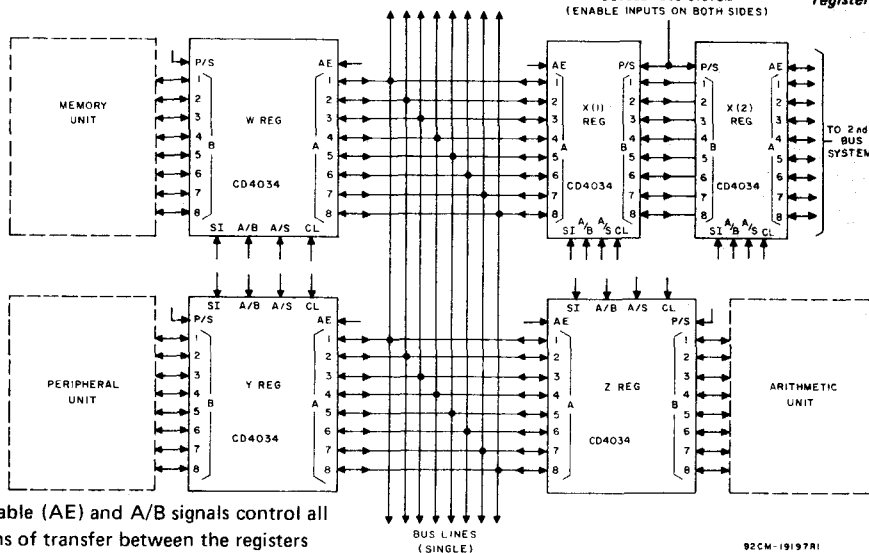

Fig. 18 - 16-bit serial in/gated parallel out register.



The "A" enable (AE) and A/B signals control all combinations of transfer between the registers and bus systems.

Fig. 19 - Single- and double-bus systems.

# CD4034B Types

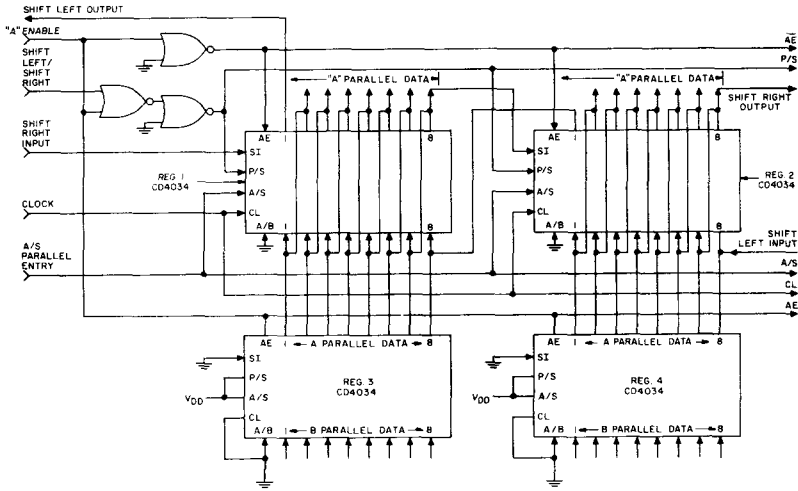

A "High" ("Low") on the shift Left/Shift Right input allows serial data on the Shift Left Input (Shift Right Input) to enter the register on the positive transition of the clock signal. A "high" on the "A" Enable Input disables the "A" parallel data lines on Reg. 1 and 2 and enables the "A" data lines on registers 3 and 4 and allows parallel data

Fig. 20 - Shift right/shift left with parallel inputs.

into registers 1 and 2. Other logic schemes may be used in place of registers 3 and 4 for parallel loading.

When parallel inputs are not used Reg. 3 and 4 and associated logic are not required.

\* Shift left input must be disabled during parallel entry.

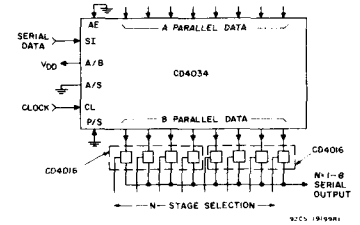

Fig. 21 - N-stage shift register with fixed serial output line.

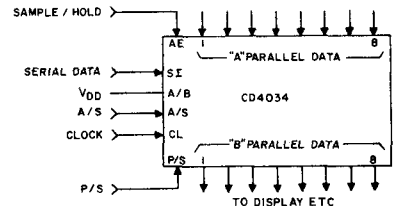
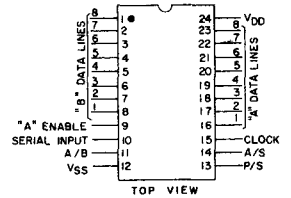
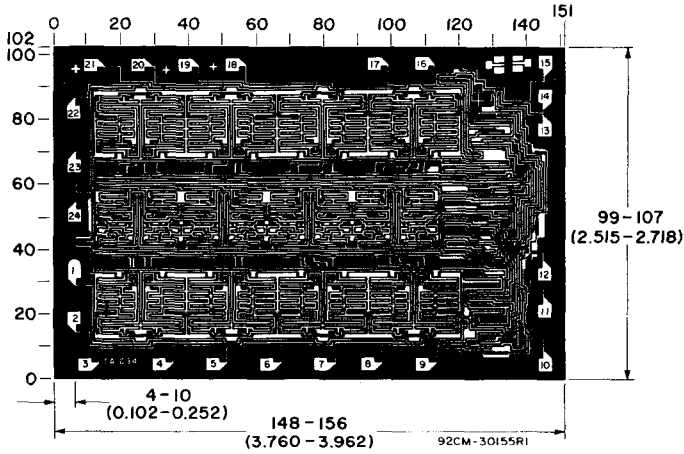

Fig. 22 - Sample and hold register - serial/parallel in - parallel out.



## TERMINAL DIAGRAM



Dimensions and pad layout for CD4034BH.

Dimensions in parentheses are in millimeters and are derived from the basic inch dimensions as indicated. Grid graduations are in mils ( $10^{-3}$  inch).

The photographs and dimensions of each CMOS chip represent a chip when it is part of the wafer. When the wafer is separated into individual chips, the angle of cleavage may vary with respect to the chip face for different chips. The actual dimensions of the isolated chip, therefore, may differ slightly from the nominal dimensions shown. The user should consider a tolerance of  $-3$  mils to  $+16$  mils applicable to the nominal dimensions shown.

# CD4035B Types

## CMOS 4-Stage Parallel In/Parallel Out Shift Register

with J-K Serial Inputs and True/Complement Outputs

High-Voltage Types (20-Volt Rating)

The RCA-CD4035B is a four-stage clocked signal serial register with provision for synchronous PARALLEL inputs to each stage and SERIAL inputs to the first stage via JK logic. Register stages 2, 3, and 4 are coupled in a serial D flip-flop configuration when the register is in the serial mode (PARALLEL/SERIAL control low).

Parallel entry into each register stage is permitted when the PARALLEL/SERIAL control is high.

In the parallel or serial mode information is transferred on positive clock transitions.

When the TRUE/COMPLEMENT control is high, the true contents of the register are available at the output terminals. When the TRUE/COMPLEMENT control is low, the outputs are the complements of the data in the register. The TRUE/COMPLEMENT control functions asynchronously with respect to the CLOCK signal.

JK input logic is provided on the first stage SERIAL input to minimize logic requirements particularly in counting and sequence-generation applications. With JK inputs connected together, the first stage becomes a D flip-flop. An asynchronous common RESET is also provided.

The CD4035B types are supplied in 16-lead hermetic dual-in-line ceramic packages (D and F suffixes), 16-lead dual-in-line plastic packages (E suffix), 16-lead ceramic flat packages (K suffix), and in chip form (H suffix).

### Features:

- 4-Stage clocked shift operation
- Synchronous parallel entry on all 4 stages
- JK inputs on first stage
- Asynchronous True/Complement control on all outputs
- Static flip-flop operation; Master-slave configuration
- Buffered inputs and outputs
- High speed — 12 MHz (typ.) at  $V_{DD} = 10\text{ V}$
- 100% tested for quiescent current at 20 V
- Standardized, symmetrical output characteristics
- 5-V, 10-V, and 15-V parametric ratings
- Meets all requirements of JEDEC Tentative Standard No. 13A, "Standard Specifications for Description of "B" Series CMOS Devices"

### Applications:

- Counters, Registers
- Arithmetic-unit registers
- Shift-left — shift right registers
- Serial-to-parallel/parallel-to-serial conversions
- Sequence generation
- Control circuits
- Code conversion

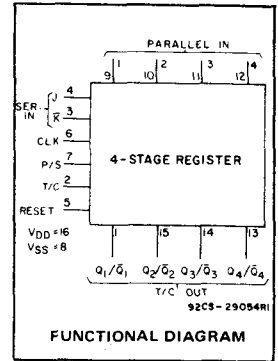

FIRST STAGE TRUTH TABLE

CL	$I_{n-1}$ (INPUTS)			$I_n$ (OUTPUTS)	
	J	K	R	$Q_{n-1}$	$Q_n$
0	X	X	0	0	0
1	X	X	0	0	1
0	X	X	1	1	0
1	X	X	1	1	1
X	X	X	0	$Q_{n-1}$	$\bar{Q}_{n-1}$ TOGGLE MODE
X	X	X	1	$Q_{n-1}$	$Q_{n-1}$
X	X	X	1	X	0

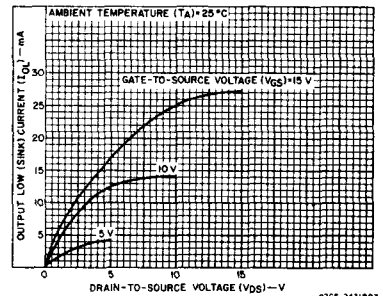

Fig. 1 — Typical output low (sink) current characteristics.

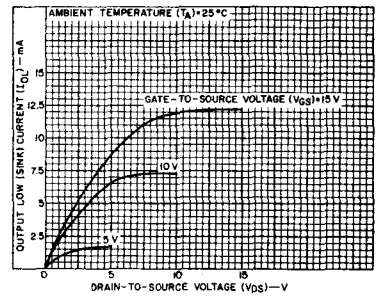

Fig. 2 — Minimum output low (sink) current characteristics.

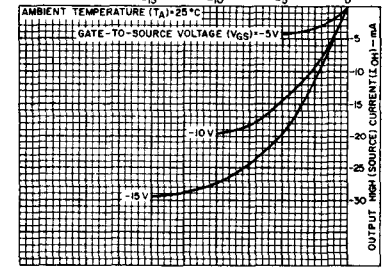

Fig. 3 — Typical output high (source) current characteristics.

### MAXIMUM RATINGS, Absolute-Maximum Values:

- DC SUPPLY-VOLTAGE RANGE, ( $V_{DD}$ )
  - (Voltages referenced to  $V_{SS}$  Terminal) ..... -0.5 to +20 V
- INPUT VOLTAGE RANGE, ALL INPUTS ..... -0.5 to  $V_{DD} + 0.5\text{ V}$
- DC INPUT CURRENT, ANY ONE INPUT .....  $\pm 10\text{ mA}$
- POWER DISSIPATION PER PACKAGE ( $P_D$ ):
  - For  $T_A = -40$  to  $+60^\circ\text{C}$  (PACKAGE TYPE E) ..... 500 mW
  - For  $T_A = +60$  to  $+85^\circ\text{C}$  (PACKAGE TYPE E) ..... Derate Linearly at  $12\text{ mW}/^\circ\text{C}$  to 200 mW
  - For  $T_A = -55$  to  $+100^\circ\text{C}$  (PACKAGE TYPES D, F, K) ..... 500 mW
  - For  $T_A = +100$  to  $+125^\circ\text{C}$  (PACKAGE TYPES D, F, K) ..... Derate Linearly at  $12\text{ mW}/^\circ\text{C}$  to 200 mW
- DEVICE DISSIPATION PER OUTPUT TRANSISTOR
  - For  $T_A = \text{FULL PACKAGE-TEMPERATURE RANGE (All Package Types)}$  ..... 100 mW
- OPERATING-TEMPERATURE RANGE ( $T_A$ ):
  - PACKAGE TYPES D, F, K, H ..... -55 to  $+125^\circ\text{C}$
  - PACKAGE TYPE E ..... -40 to  $+85^\circ\text{C}$
- STORAGE TEMPERATURE RANGE ( $T_{stg}$ ) ..... -65 to  $+150^\circ\text{C}$
- LEAD TEMPERATURE (DURING SOLDERING):
  - At distance  $1/16 \pm 1/32$  inch ( $1.59 \pm 0.79\text{ mm}$ ) from case for 10 s max. ....  $+265^\circ\text{C}$

# CD4035B Types

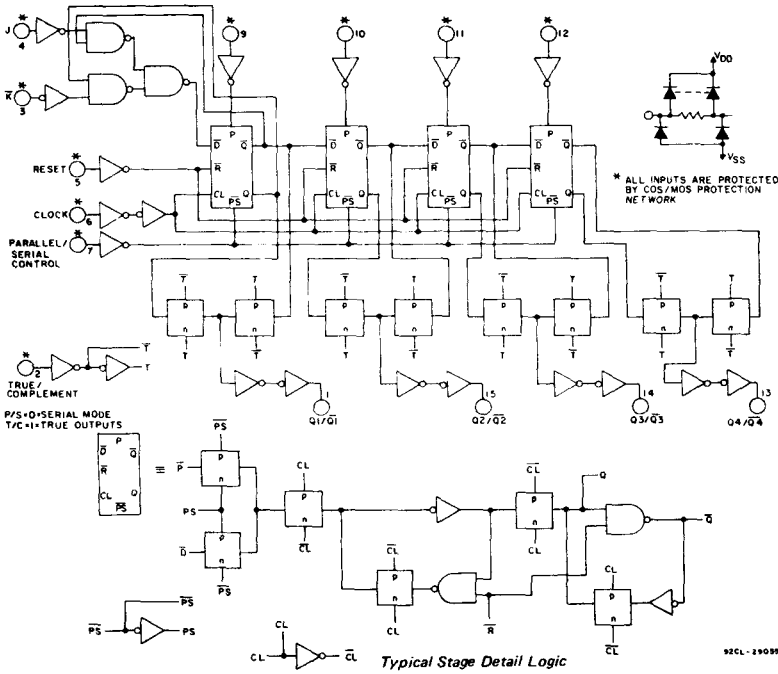

Fig. 4 - Logic diagram.

**RECOMMENDED OPERATING CONDITIONS** at  $T_A = 25^\circ\text{C}$ , Except as Noted.  
For maximum reliability, nominal operating conditions should be selected so that operation is always within the following ranges:

CHARACTERISTIC	$V_{DD}$ (V)	LIMITS		UNITS
		MIN.	MAX.	
Supply-Voltage Range (For $T_A = \text{Full Package-Temperature Range}$ )		3	18	V
Data Setup Time, $t_s$ : J/ $\bar{K}$ Lines	5	220	—	ns
	10	80	—	
	15	60	—	
Parallel-In Lines	5	140	—	ns
	10	50	—	
	15	40	—	
Clock Pulse Width, $t_{W}$	5	200	—	ns
	10	90	—	
	15	60	—	
Clock Input Frequency, $f_{CL}$	5	—	2	MHz
	10	dc	6	
	15	—	8	
Clock Rise or Fall Time, $t_r, t_f$ : $t_r, t_f$ :CL:	5	—	15	$\mu\text{s}$
	10	—	15	
	15	—	15	
Reset Pulse Width, $t_{WR}$	5	250	—	ns
	10	110	—	
	15	80	—	

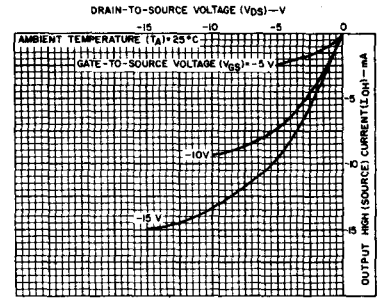

Fig. 5 - Minimum output high (source) current characteristics.

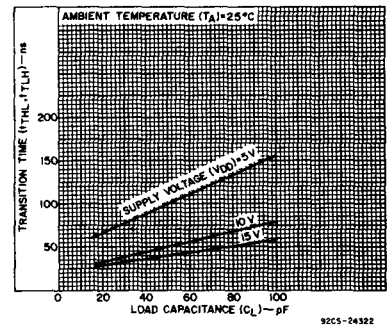

Fig. 6 - Typical transition time as a function of load capacitance.

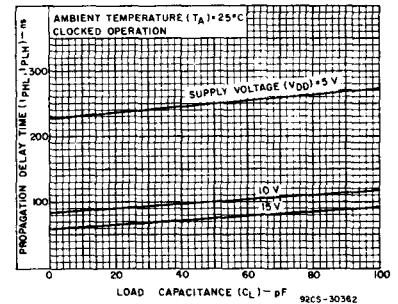

Fig. 7 - Typical propagation delay times as a function of load capacitance (Q output).

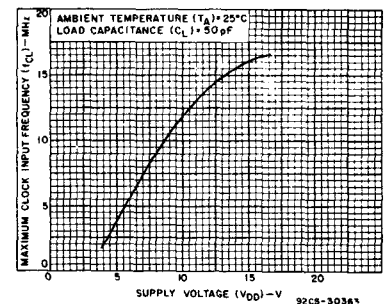

Fig. 8 - Typical maximum clock input frequency as a function of supply voltage.

# CD4035B Types

## STATIC ELECTRICAL CHARACTERISTICS

CHARACTERISTIC	CONDITIONS			LIMITS AT INDICATED TEMPERATURES (°C)							UNITS
				Values at -55, +25, +125 Apply to D, F, K, H, Packages Values at -40, +25, +85 Apply to E Package							
	V <sub>O</sub> (V)	V <sub>IN</sub> (V)	V <sub>DD</sub> (V)	-55	-40	+85	+125	+25			
								Min.	Typ.	Max.	
Quiescent Device Current, I <sub>DD</sub> Max.	-	0,5	5	5	5	150	150	-	0,04	5	μA
	-	0,10	10	10	10	300	300	-	0,04	10	
	-	0,15	15	20	20	600	600	-	0,04	20	
	-	0,20	20	100	100	3000	3000	-	0,08	100	
Output Low (Sink) Current, I <sub>OL</sub> Min.	0,4	0,5	5	0,64	0,61	0,42	0,36	0,51	1	-	
	0,5	0,10	10	1,6	1,5	1,1	0,9	1,3	2,6	-	
	1,5	0,15	15	4,2	4	2,8	2,4	3,4	6,8	-	
Output High (Source) Current, I <sub>OH</sub> Min.	4,6	0,5	5	-0,64	-0,61	-0,42	-0,36	-0,51	-1	-	mA
	2,5	0,5	5	-2	-1,8	-1,3	-1,15	-1,6	-3,2	-	
	9,5	0,10	10	-1,6	-1,5	-1,1	-0,9	-1,3	-2,6	-	
	13,5	0,15	15	-4,2	-4	-2,8	-2,4	-3,4	-6,8	-	
Output Voltage: Low-Level, V <sub>OL</sub> Max.	-	0,5	5	0,05				-	0	0,05	V
	-	0,10	10	0,05				-	0	0,05	
	-	0,15	15	0,05				-	0	0,05	
Output Voltage: High-Level, V <sub>OH</sub> Min.	-	0,5	5	4,95				4,95	5	-	
	-	0,10	10	9,95				9,95	10	-	
	-	0,15	15	14,95				14,95	15	-	
Input Low Voltage, V <sub>IL</sub> Max.	0,5, 4,5		5	1,5				-	-	1,5	V
	1,9		10	3				-	-	3	
	1,5, 13,5		15	4				-	-	4	
Input High Voltage, V <sub>IH</sub> Min.	0,5, 4,5		5	3,5				3,5	-	-	
	1,9		10	7				7	-	-	
	1,5, 13,5		15	11				11	-	-	
Input Current I <sub>IN</sub> Max.		0,18	18	±0,1	±0,1	±1	±1	-	±10 <sup>-5</sup>	±0,1	μA

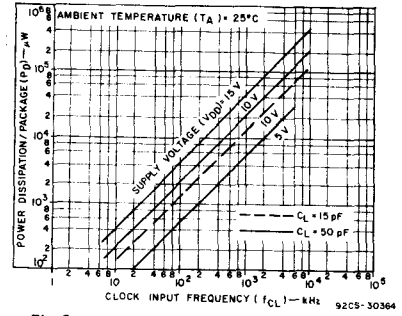

Fig. 9 - Typical dynamic power dissipation as a function of clock input frequency.

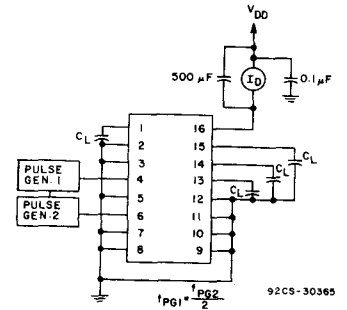

Fig. 10 - Dynamic power dissipation test circuit.

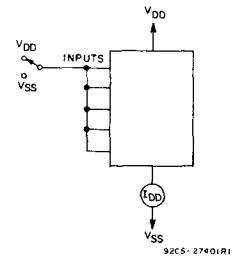

Fig. 11 - Quiescent-device current test circuit.

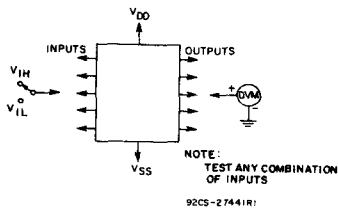

Fig. 12 - Input-voltage test circuit.

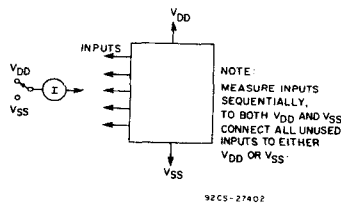

Fig. 13 - Input-current test circuit.

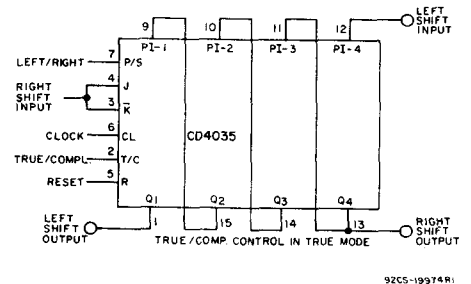
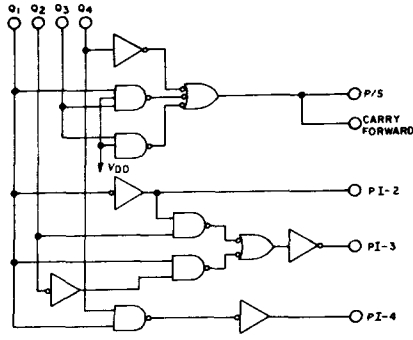

Fig. 14 - Shift left/shift right register.



# CD4035B Types



Using Couleur's Technique (BIDECC)<sup>▲</sup>, a binary number (most significant bit, MSB) first is shifted and processed, such that the BCD equivalent is obtained when the last binary bit is clocked into the register. The CD4035B, with the correct conversion logic, can also be used as a BCD-to-binary converter.

<sup>▲</sup>The basic rule is: If a 4 or less is in a decade, shift with the next clock pulse; if a 5 or greater is in a decade, add 3 and then shift at the next clock pulse. For more information refer to "IRE TRANSACTIONS ON ELECTRONIC COMPUTERS", Dec. 1958, Pages 313-316.

Fig. 15 - BIDECC logic.

## DYNAMIC ELECTRICAL CHARACTERISTICS

At  $T_A = 25^\circ C$ , Input  $t_r, t_f = 20 ns$ ,  $C_L = 50 pF$ ,  $R_L = 200 k\Omega$

CHARACTERISTICS	TEST CONDITIONS	LIMITS			UNITS	
		$V_{DD}$ (V)	Min.	Typ.		Max.
<b>CLOCKED OPERATION</b>						
Propagation Delay Time: $t_{PHL}, t_{PLH}$		5	-	250	500	ns
		10	-	100	200	
		15	-	75	150	
Transition Time: $t_{THL}, t_{TLH}$		5	-	100	200	ns
		10	-	50	100	
		15	-	40	80	
Minimum Clock Pulse Width, $t_W$		5	-	100	200	ns
		10	-	45	90	
		15	-	30	60	
Clock Rise or Fall Time, $t_{rCL}, t_{fCL}^*$		5, 10, 15	-	-	15	$\mu s$
Minimum Setup Time: J/K Lines		5	-	110	220	ns
		10	-	40	80	
		15	-	30	60	
Parallel-In-Lines		5	-	70	140	ns
		10	-	25	50	
		15	-	20	40	
Maximum Clock Frequency, $f_{CL}$		5	2	4	-	MHz
		10	6	12	-	
		15	8	16	-	
Input Capacitance, $C_{iN}$	Any Input	-	5	7.5	$\mu F$	
<b>RESET OPERATION</b>						
Propagation Delay Time: $t_{PHL}, t_{PLH}$		5	-	230	460	ns
		10	-	100	200	
		15	-	80	160	
Minimum Reset Pulse Width, $t_W$		5	-	125	250	ns
		10	-	55	110	
		15	-	40	40	

\*If more than one unit is cascaded  $t_{rCL}$  should be made less than or equal to the sum of the transition time and the fixed propagation delay of the output of the driving stage for the estimated capacitive load.

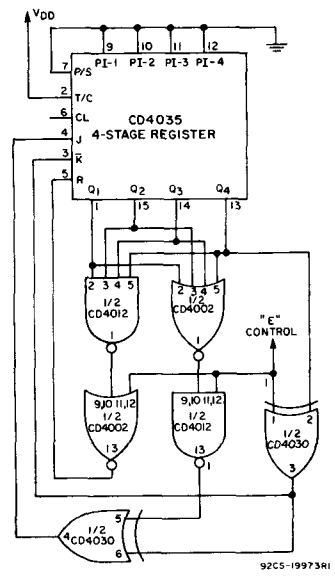

Fig. 16(a) - Double sequence generator.

Control = E = 0					1				
$Q_1$	$Q_2$	$Q_3$	$Q_4$		$Q_1$	$Q_2$	$Q_3$	$Q_4$	
A	B	C	D		A	B	C	D	
0	0	0	0	0	15	1	1	1	1
1	1	0	0	0	14	0	1	1	1
2	0	1	0	0	13	1	0	1	1
5	1	0	1	0	10	0	1	0	1
10	0	1	0	1	5	1	0	1	0
4	0	0	1	0	11	1	1	0	1
9	1	0	0	1	6	0	1	1	0
3	1	1	0	0	12	0	0	1	1
6	0	1	1	0	9	1	0	0	1
13	1	0	1	1	2	0	1	0	0
11	1	1	0	1	4	0	0	1	0
7	1	1	1	0	8	0	0	0	1
14	0	1	1	1	1	1	0	0	0
12	0	0	1	1	3	1	1	0	0
8	0	0	0	1	7	1	1	1	0

Using a control line (E) two different state sequences can be generated. For example, suppose the following two sequences are desired on command (control line E)

Fig. 16(b) - State sequences.



# CMOS Quad True/Complement Buffer

## High Voltage Types (20-Volt Rating)

The RCA-CD4041UB types are quad true/complement buffers consisting of n- and p-channel units having low channel resistance and high current (sourcing and sinking) capability. The CD4041UB is intended for use as a buffer, line driver, or CMOS-to-TTL driver. It can be used as an ultra-low power resistor-network driver for A/D and D/A conversion, as a transmission-line driver, and in other applications where high noise immunity and low power dissipation are primary design requirements.

The CD4041UB types are supplied in 14-lead hermetic dual-in-line ceramic packages (D and F suffixes), 14-lead dual-in-line plastic packages (E suffix), 14-lead ceramic flat packages (K suffix), and in chip form (H suffix).

### MAXIMUM RATINGS, Absolute-Maximum Values:

DC SUPPLY-VOLTAGE RANGE, ( $V_{DD}$ ) (Voltages referenced to $V_{SS}$ Terminal)	-0.5 to +20 V
INPUT VOLTAGE RANGE, ALL INPUTS	-0.5 to $V_{DD} + 0.5$ V
DC INPUT CURRENT, ANY ONE INPUT	$\pm 10$ mA
POWER DISSIPATION PER PACKAGE ( $P_D$ ):	
For $T_A = -40$ to $+60^\circ\text{C}$ (PACKAGE TYPE E)	500 mW
For $T_A = +60$ to $+85^\circ\text{C}$ (PACKAGE TYPE E)	Derate Linearly at 12 mW/ $^\circ\text{C}$ to 200 mW
For $T_A = -55$ to $+100^\circ\text{C}$ (PACKAGE TYPES D, F, K)	500 mW
For $T_A = +100$ to $+125^\circ\text{C}$ (PACKAGE TYPES D, F, K)	Derate Linearly at 12 mW/ $^\circ\text{C}$ to 200 mW
DEVICE DISSIPATION PER OUTPUT TRANSISTOR	
For $T_A = \text{FULL PACKAGE-TEMPERATURE RANGE}$ (All Package Types)	100 mW
OPERATING-TEMPERATURE RANGE ( $T_A$ ):	
PACKAGE TYPES D, F, K, H	-55 to $+125^\circ\text{C}$
PACKAGE TYPE E	-40 to $+85^\circ\text{C}$
STORAGE TEMPERATURE RANGE ( $T_{stg}$ )	-65 to $+150^\circ\text{C}$
LEAD TEMPERATURE (DURING SOLDERING):	
At distance 1/16 $\pm$ 1/32 inch (1.59 $\pm$ 0.79 mm) from case for 10 s max.	$+265^\circ\text{C}$

### RECOMMENDED OPERATING CONDITIONS

For maximum reliability, nominal operating conditions should be selected so that operation is always within the following range:

CHARACTERISTIC	LIMITS		UNITS
	Min.	Max.	
Supply-Voltage Range (For $T_A = \text{Full Package-Temperature Range}$ )	3	18	V

### Features:

- Balanced sink and source current; approximately 4 times standard "B" drive
- Equalized delay to true and complement outputs
- 100% tested for quiescent current at 20 V
- Maximum input current of 1  $\mu\text{A}$  at 18 V over full package temperature range; 100 nA at 18 V and  $25^\circ\text{C}$
- 5-V, 10-V, and 15-V parametric ratings
- Meets all requirements of JEDEC Tentative Standard No. 13A, "Standard Specifications for Description of 'B' Series CMOS Devices"

### Applications:

- High current source/sink driver
- CMOS-to-DTL/TTL Converter Buffer
- Display driver
- MOS clock driver
- Resistor network driver (Ladder or weighted R)
- Buffer
- Transmission line driver

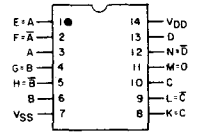
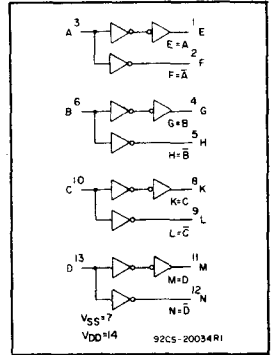

92CS-20756R1

### TOP VIEW TERMINAL ASSIGNMENT

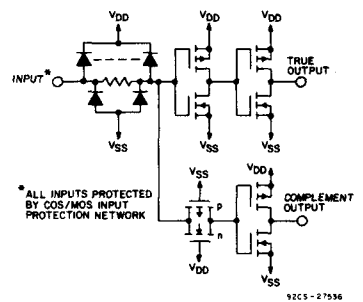

92CS-27556

Fig. 1 - Schematic diagram 1 of 4 buffers.

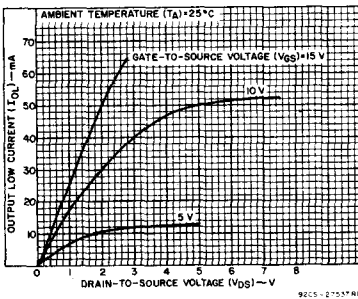

Fig. 2 - Typical output low (sink) current characteristics.

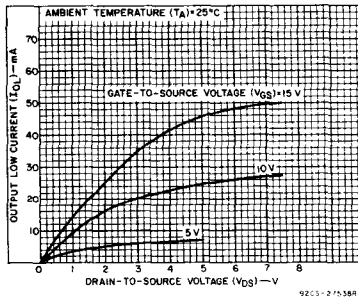

Fig. 3 - Minimum output low (sink) current characteristics.

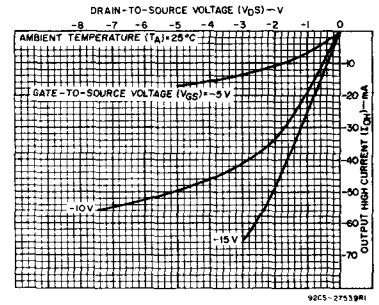

Fig. 4 - Typical output high (source) current characteristics.

# CD4041UB Types

## STATIC ELECTRICAL CHARACTERISTICS

CHARACTERISTIC	CONDITIONS			LIMITS AT INDICATED TEMPERATURES (°C)							UNITS		
	V <sub>O</sub> (V)	V <sub>IN</sub> (V)	V <sub>DD</sub> (V)	Values at -55, +25, +125 Apply to D, F, K, H, Packages				Values at -40, +25, +85 Apply to E Pkgs.					
				-55	-40	+85	+125	+25					
											Min.	Typ.	Max.
Quiescent Device Current	-	0,5	5	1	1	30	30	-	0.02	1	μA		
I <sub>DD</sub> Max.	-	0,10	10	2	2	60	60	-	0.02	2			
	-	0,15	15	4	4	120	120	-	0.02	4			
Output Low (Sink) Current, I <sub>OL</sub> Min.	0,4	0,5	5	2.1	1.8	1.3	1.2	1.6	3.2	-	mA		
	0,5	0,10	10	6.25	5.6	4	3.5	5	10	-			
	1,5	0,15	15	24	23	15.5	13	19	38	-			
Output High (Source) Current, I <sub>OH</sub> Min.	4.6	0,5	5	-2.1	-1.8	-1.3	-1.2	-1.6	-3.2	-	mA		
	2,5	0,5	5	-8.4	-6.7	-5.3	-4.6	-6.4	-12.8	-			
	9,5	0,10	10	-6.25	-5.6	-4	-3.5	-5	-10	-			
Output Voltage: Low-Level, V <sub>OL</sub> Max.	-	0,5	5	0.05				-	0	0.05	V		
	-	0,10	10	0.05				-	0	0.05			
	-	0,15	15	0.05				-	0	0.05			
Output Voltage: High-Level, V <sub>OH</sub> Min.	-	0,5	5	4.95				4.95	5	-	V		
	-	0,10	10	9.95				9.95	10	-			
	-	0,15	15	14.95				14.95	15	-			
Input Low Voltage, V <sub>IL</sub> Max.	0,5, 4,5	-	5	1				-	-	1	V		
	1,9	-	10	2				-	-	2			
	1,5, 13,5	-	15	2.5				-	-	2.5			
Input High Voltage, V <sub>IH</sub> Min.	0,5, 4,5	-	5	4				4	-	-	V		
	1,9	-	10	8				8	-	-			
	1,5, 13,5	-	15	12.5				12.5	-	-			
Input Current, I <sub>IN</sub> Max.	-	0,18	18	±0.1	±0.1	±1	±1	-	±10 <sup>-5</sup>	±0.1	μA		

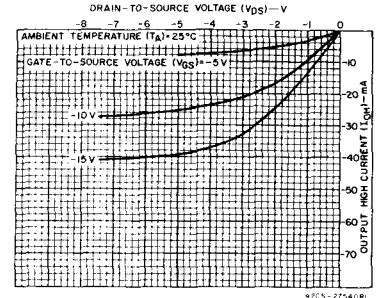

Fig. 5 - Minimum output high (source) current characteristics.

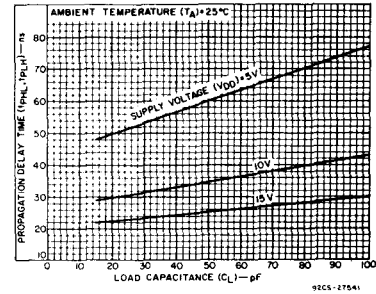

Fig. 6 - Typical propagation delay time vs. load capacitance.

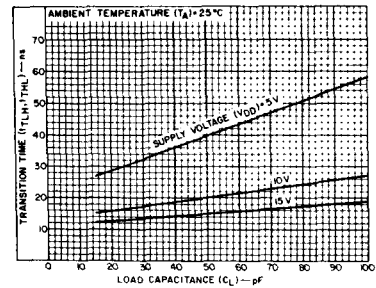

Fig. 7 - Typical transition time vs. load capacitance.

DYNAMIC ELECTRICAL CHARACTERISTICS at T<sub>A</sub> = 25°C, Input t<sub>r</sub>, t<sub>f</sub> = 20 ns, C<sub>L</sub> = 50 pF, R<sub>L</sub> = 200 kΩ

CHARACTERISTIC	CONDITIONS	ALL TYPES LIMITS		UNITS	
		V <sub>DD</sub> Volts	Typ.		Max.
Propagation Delay Time:	t <sub>PHL</sub>	5	60	120	ns
	t <sub>PLH</sub>	10	35	70	
	t <sub>PLH</sub>	15	25	50	
Transition Time	t <sub>THL</sub>	5	40	80	ns
	t <sub>TLH</sub>	10	20	40	
	t <sub>TLH</sub>	15	15	30	
Input Capacitance	C <sub>IN</sub>	Any Input	15	22.5	pF

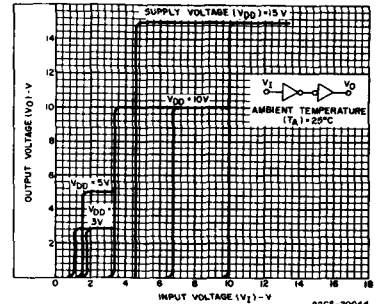

Fig. 8 - Minimum and maximum transfer characteristics - true output.

# CD4041UB Types

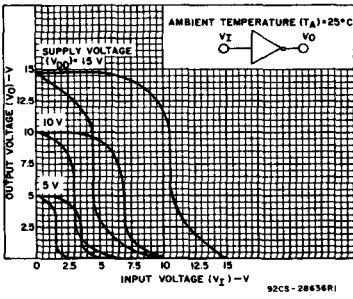

Fig. 9 - Minimum and maximum transfer characteristics - complement output.

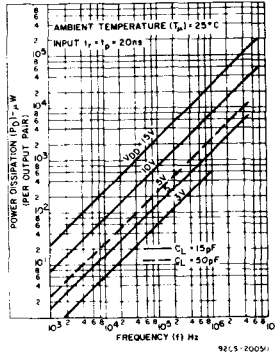

Fig. 11 - Typical power dissipation vs frequency per output pair.

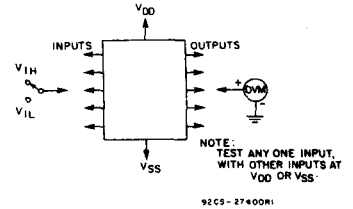

Fig. 13 - Input voltage test circuit.

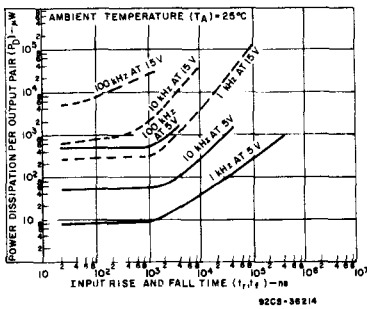

Fig. 10 - Typical power dissipation vs. input rise & fall time per output pair.

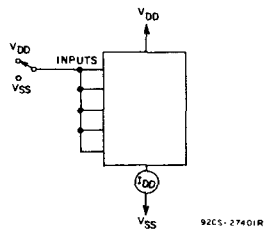

Fig. 12 - Quiescent device current test circuit.

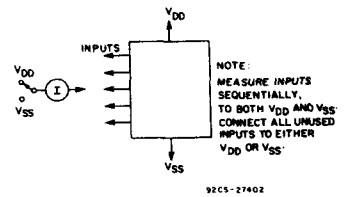
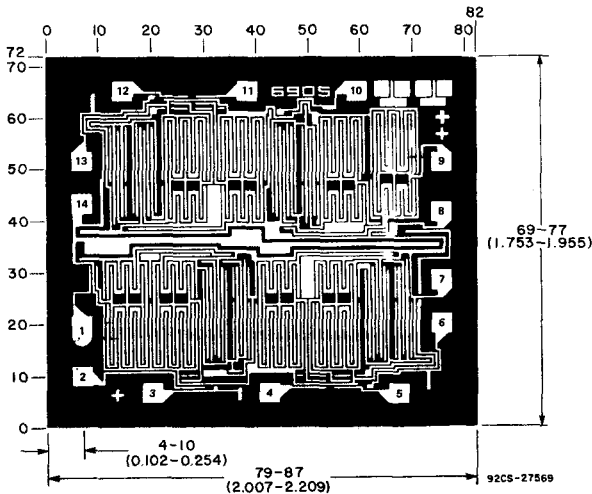

Fig. 14 - Input-leakage-current test circuit.

## Dimensions and pad layout for the CD4041UBH



Dimensions in parentheses are in millimeters and are derived from the basic inch dimensions as indicated. Grid graduations are in mils ( $10^{-3}$  inch).

The photographs and dimensions of each CMOS chip represent a chip when it is part of the wafer. When the wafer is separated into individual chips, the angle of cleavage may vary with respect to the chip face for different chips. The actual dimensions of the isolated chip, therefore, may differ slightly from the nominal dimensions shown. The user should consider a tolerance of  $-3$  mils to  $+16$  mils applicable to the nominal dimensions shown.

# CD4042B Types

## CMOS

### Quad Clocked "D" Latch

High-Voltage Types (20-Volt Rating)

The RCA-CD4042B types contain four latch circuits, each strobed by a common clock. Complementary buffered outputs are available from each circuit. The impedance of the n- and p-channel output devices is balanced and all outputs are electrically identical. Information present at the data input is transferred to outputs Q and  $\bar{Q}$  during the CLOCK level which is programmed by the POLARITY input. For POLARITY = 0 the transfer occurs during the 0 CLOCK level and for POLARITY = 1 the transfer occurs during the 1 CLOCK level. The outputs follow the data input providing the CLOCK and POLARITY levels defined above are present. When a CLOCK transition occurs (positive for POLARITY = 0 and negative for POLARITY = 1) the information present at the input during the CLOCK transition is retained at the outputs until an opposite CLOCK transition occurs.

The GD4042B types are supplied in 16-lead hermetic dual-in-line ceramic packages (D and F suffixes), 16-lead dual-in-line plastic package (E suffix), 16-lead ceramic flat package (K suffix), and in chip form (H suffix).

#### Features:

- Clock polarity control
- Q and  $\bar{Q}$  outputs
- Common clock
- Low power TTL compatible
- Standardized symmetrical output characteristics
- 100% tested for quiescent current at 20 V
- Maximum input current of 1  $\mu$ A at 18 V over full package-temperature range; 100 nA at 18 V and 25°C
- 5-V, 10-V, and 15-V parametric ratings
- Noise margin (over full package temperature range):
  - 1 V at  $V_{DD} = 5$  V
  - 2 V at  $V_{DD} = 10$  V
  - 2.5 V at  $V_{DD} = 15$  V
- Meets all requirements of JEDEC Tentative Standard No. 13A, "Standard Specifications for Description of 'B' Series CMOS Devices"

#### Applications:

- Buffer storage
- Holding register
- General digital logic

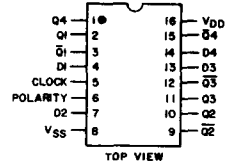
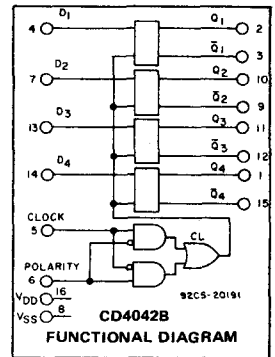

#### TERMINAL ASSIGNMENT

#### STATIC ELECTRICAL CHARACTERISTICS

CHARACTERISTIC	CONDITIONS			LIMITS AT INDICATED TEMPERATURES (°C)							UNITS
	$V_O$ (V)	$V_{IN}$ (V)	$V_{DD}$ (V)	Values at -55, +25, +125 Apply to D, F, K, H Pkgs.				Values at -40, +25, +85 Apply to E Pkgs.			
				-55	-40	+85	+125	Min.	Typ.	Max.	
Quiescent Device Current $I_{DD}$ Max.	-	0.5	5	1	1	30	30	-	0.02	1	$\mu$ A
	-	0.10	10	2	2	60	60	-	0.02	2	
	-	0.15	15	4	4	120	120	-	0.02	4	
Output Low (Sink) Current $I_{OL}$ Min.	0.4	0.5	5	0.64	0.61	0.42	0.36	0.51	1	-	mA
	0.5	0.10	10	1.6	1.5	1.1	0.9	1.3	2.6	-	
	1.5	0.15	15	4.2	4	2.8	2.4	3.4	6.8	-	
Output High (Source) Current $I_{OH}$ Min.	4.6	0.5	5	-0.64	-0.61	-0.42	-0.36	-0.51	-1	-	mA
	2.5	0.5	5	-2	-1.8	-1.3	-1.15	-1.6	-3.2	-	
	9.5	0.10	10	-1.6	-1.5	-1.1	-0.9	-1.3	-2.6	-	
Output Voltage: Low-Level, $V_{OL}$ Max.	-	0.5	5	0.05				-	0	0.05	V
	-	0.10	10	0.05				-	0	0.05	
	-	0.15	15	0.05				-	0	0.05	
Output Voltage: High-Level, $V_{OH}$ Min.	-	0.5	5	4.95				4.95	5	-	V
	-	0.10	10	9.95				9.95	10	-	
	-	0.15	15	14.95				14.95	15	-	
Input Low Voltage, $V_{IL}$ Max.	0.5, 4.5	-	5	1.5				-	-	1.5	V
	1.9	-	10	3				-	-	3	
	1.5, 13.5	-	15	4				-	-	4	
Input High Voltage, $V_{IH}$ Min.	0.5, 4.5	-	5	3.5				3.5	-	-	V
	1.9	-	10	7				7	-	-	
	1.5, 13.5	-	15	11				11	-	-	
Input Current, $I_{IN}$ Max.	-	0.18	18	$\pm 0.1$	$\pm 0.1$	$\pm 1$	$\pm 1$	-	$\pm 10^{-5}$	$\pm 0.1$	$\mu$ A

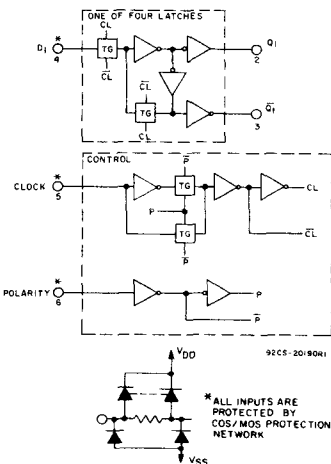

CLOCK	POLARITY	Q
0	0	D
1	0	LATCH
0	1	D
1	1	LATCH

Fig. 1 - Logic block diagram and truth table.

# CD4042B Types

## MAXIMUM RATINGS, Absolute-Maximum Values:

DC SUPPLY-VOLTAGE RANGE, ( $V_{DD}$ )	(Voltages referenced to $V_{SS}$ Terminal)	-0.5 to +20 V
INPUT VOLTAGE RANGE, ALL INPUTS		-0.5 to $V_{DD} + 0.5$ V
DC INPUT CURRENT, ANY ONE INPUT		$\pm 10$ mA
POWER DISSIPATION PER PACKAGE ( $P_D$ ):		
For $T_A = -40$ to $+60^\circ\text{C}$ (PACKAGE TYPE E)		500 mW
For $T_A = +60$ to $+85^\circ\text{C}$ (PACKAGE TYPE E)	Derate Linearly at $12\text{ mW}/^\circ\text{C}$	to 200 mW
For $T_A = -55$ to $+100^\circ\text{C}$ (PACKAGE TYPES D, F, K)		500 mW
For $T_A = +100$ to $+125^\circ\text{C}$ (PACKAGE TYPES D, F, K)	Derate Linearly at $12\text{ mW}/^\circ\text{C}$	to 200 mW
DEVICE DISSIPATION PER OUTPUT TRANSISTOR		
For $T_A = \text{FULL PACKAGE-TEMPERATURE RANGE}$ (All Package Types)		100 mW
OPERATING-TEMPERATURE RANGE ( $T_A$ ):		
PACKAGE TYPES D, F, K, H		$-55$ to $+125^\circ\text{C}$
PACKAGE TYPE E		$-40$ to $+85^\circ\text{C}$
STORAGE TEMPERATURE RANGE ( $T_{stg}$ )		$-65$ to $+150^\circ\text{C}$
LEAD TEMPERATURE (DURING SOLDERING):		
At distance $1/16 \pm 1/32$ inch ( $1.59 \pm 0.79$ mm) from case for 10 s max.		$+265^\circ\text{C}$

**RECOMMENDED OPERATING CONDITIONS at  $T_A = 25^\circ\text{C}$ , Except as Noted.**  
**For maximum reliability, nominal operating conditions should be selected so that operation is always within the following ranges:**

CHARACTERISTIC	$V_{DD}$ (V)	LIMITS ALL TYPES		UNITS
		Min.	Max.	
Supply-Voltage Range (For $T_A = \text{Full Package Temperature Range}$ )	—	3	18	V
Clock Pulse Width, $t_{W}$	5	200	—	ns
	10	100	—	
	15	60	—	
Setup Time, $t_s$	5	50	—	ns
	10	30	—	
	15	25	—	
Hold Time, $t_H$	5	120	—	ns
	10	60	—	
	15	50	—	
Clock Rise or Fall Time: $t_r, t_f$	5, 10	Not rise or fall time sensitive.		$\mu\text{s}$
	15			

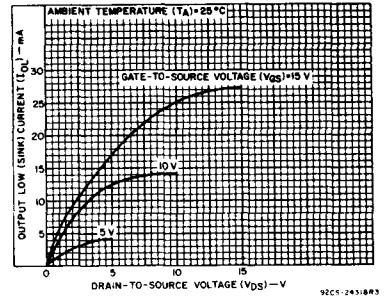

Fig. 2 — Typical output low (sink) current characteristics.

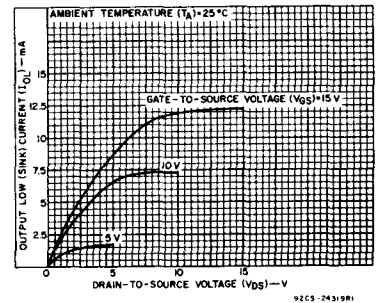

Fig. 3 — Minimum output low (sink) current characteristics.

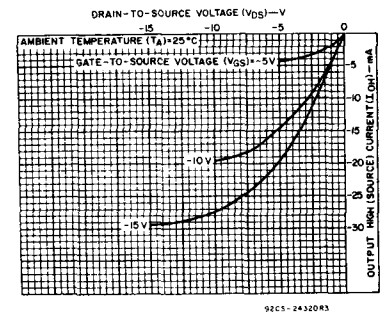

Fig. 4 — Typical output high (source) current characteristics.

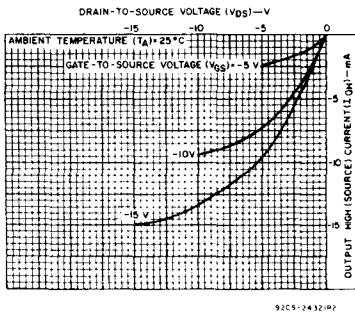

Fig. 5 — Minimum output high (source) current characteristics.

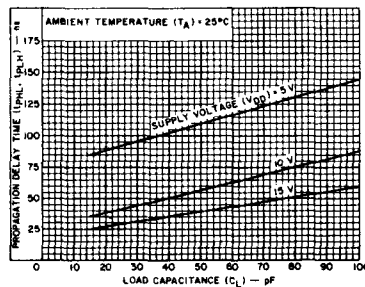

Fig. 6 — Typical propagation delay time vs. load capacitance—data to Q.

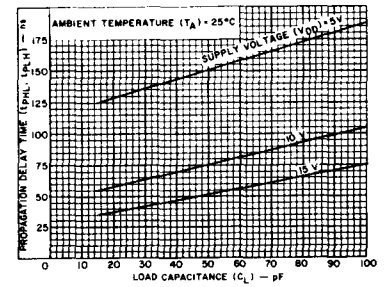

Fig. 7 — Typical propagation delay time vs. load capacitance—data to  $\bar{Q}$ .

# CD4042B Types

DYNAMIC ELECTRICAL CHARACTERISTICS at  $T_A = 25^\circ\text{C}$ ; Input  $t_r, t_f = 20\text{ ns}$ ,  $C_L = 50\text{ pF}$ ,  $R_L = 200\text{ k}\Omega$

CHARACTERISTIC	VDD (V)	LIMITS ALL TYPES		UNITS
		Typ.	Max.	
Propagation Delay Time: $t_{PHL}, t_{PLH}$ Data In to Q	5	110	220	ns
	10	55	110	
	15	40	80	
Data In to $\bar{Q}$	5	150	300	ns
	10	75	150	
	15	50	100	
Clock to Q	5	225	450	ns
	10	100	200	
	15	80	160	
Clock to $\bar{Q}$	5	250	500	ns
	10	115	230	
	15	90	180	
Transition Time: $t_{THL}, t_{TLH}$	5	100	200	ns
	10	50	100	
	15	40	80	
Minimum Clock Pulse Width, $t_W$	5	100	200	ns
	10	50	100	
	15	30	60	
Minimum Hold Time, $t_H$	5	60	120	ns
	10	30	60	
	15	25	50	
Minimum Setup Time, $t_S$	5	0	50	ns
	10	0	30	
	15	0	25	
Clock Input Rise or Fall Time: $t_r, t_f$	5, 10, 15	Not rise or fall time sensitive.		$\mu\text{s}$
Input Capacitance, $C_{IN}$ (Any Input)	—	5	7.5	pF

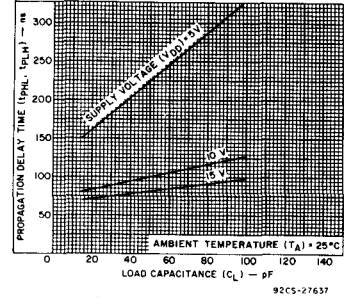

Fig. 8 - Typical propagation delay time vs. load capacitance—clock to Q

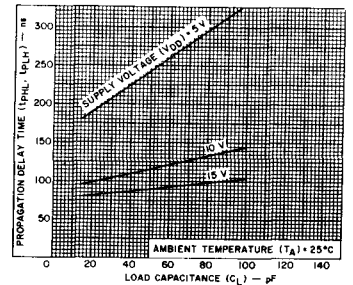

Fig. 9 - Typical propagation delay time vs. load capacitance—clock to  $\bar{Q}$ .

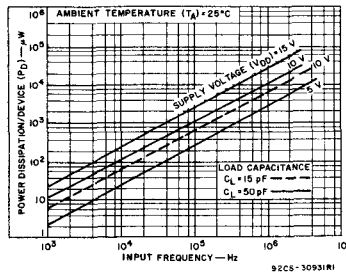

Fig. 10 - Typical power dissipation vs. frequency.

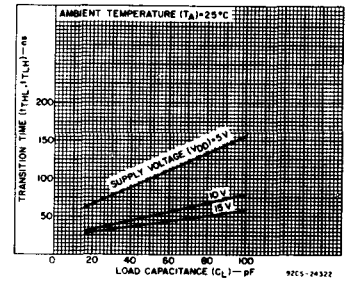
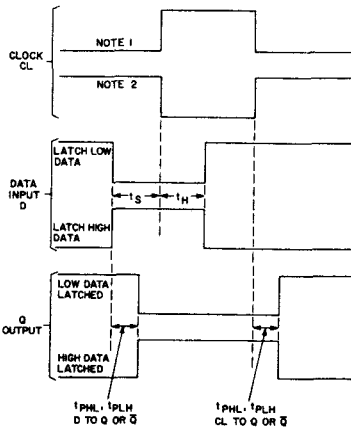

Fig. 11 - Typical transition time vs. load capacitance.



NOTES:  
1. FOR POSITIVE CLOCK EDGE, INPUT DATA IS LATCHED WHEN POLARITY IS LOW.  
2. FOR NEGATIVE CLOCK EDGE, INPUT DATA IS LATCHED WHEN POLARITY IS HIGH.

92CS-27630

Fig. 12 - Dynamic test parameters.

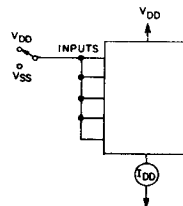

92CS-27401R1

Fig. 13 - Quiescent device current test circuit.

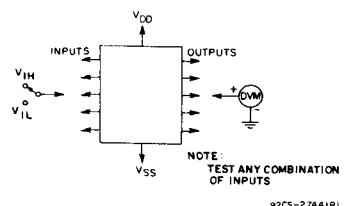

92CS-27441R1

Fig. 14 - Input voltage test circuit.



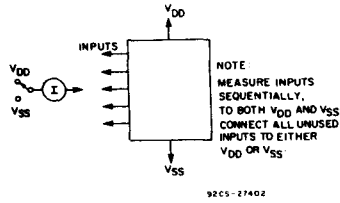
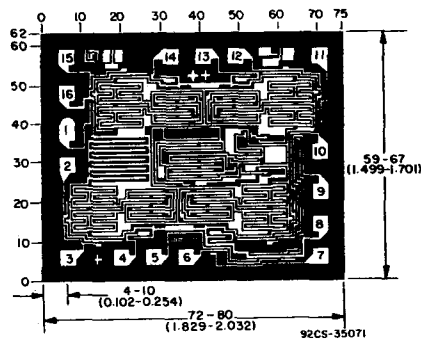

Fig. 15 - Input current test circuit.

### Chip Photograph, Dimensions, and Pad Layout



Dimensions in parentheses are in millimeters and are derived from the basic inch dimensions as indicated. Grid graduations are in mils ( $10^{-3}$  inch).

The photographs and dimensions of each CMOS chip represent a chip when it is part of the wafer. When the wafer is separated into individual chips, the angle of cleavage may vary with respect to the chip face for different chips. The actual dimensions of the isolated chip, therefore, may differ slightly from the nominal dimensions shown. The user should consider a tolerance of  $-3$  mils to  $+16$  mils applicable to the nominal dimensions shown.

# CD4043B, CD4044B Types

## CMOS Quad 3-State R/S Latches

High-Voltage Types (20-Volt Rating)  
 Quad NOR R/S Latch — CD4043B  
 Quad NAND R/S Latch — CD4044B

The RCA-CD4043B types are quad cross-coupled 3-state CMOS NOR latches and the CD4044B types are quad cross-coupled 3-state CMOS NAND latches. Each latch has a separate Q output and individual SET and RESET inputs. The Q outputs are controlled by a common ENABLE input. A logic "1" or high on the ENABLE input connects the latch states to the Q outputs. A logic "0" or low on the ENABLE input disconnects the latch states from the Q outputs, resulting in an open circuit condition on the Q outputs. The open circuit feature allows common bussing of the outputs.

The CD4043B and CD4044B types are supplied in 16-lead hermetic dual-in-line ceramic packages (D and F suffixes), 16-lead dual-in-line plastic packages (E suffix), 16-lead ceramic flat packages (K suffix), and in chip form (H suffix).

### Features:

- 3-state outputs with common output ENABLE
- Separate SET and RESET inputs for each latch
- NOR and NAND configurations
- 5-V, 10-V, and 15-V parametric ratings
- Standardized symmetrical output characteristics
- 100% tested for quiescent current at 20 V
- Maximum input current of 1  $\mu$ A at 18 V over full package temperature range; 100 nA at 18 V and 25°C
- Noise margin (over full package temperature range):
  - 1 V at  $V_{DD} = 5$  V
  - 2 V at  $V_{DD} = 10$  V
  - 2.5 V at  $V_{DD} = 15$  V

### Applications:

- Holding register in multi-register system
- Four bits of independent storage with output ENABLE
- Strobed register
- General digital logic
- CD4043B for positive logic systems
- CD4044B for negative logic systems

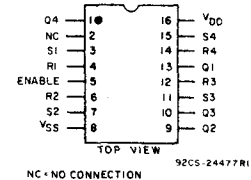
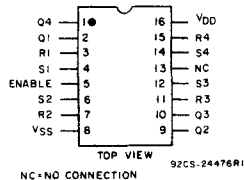
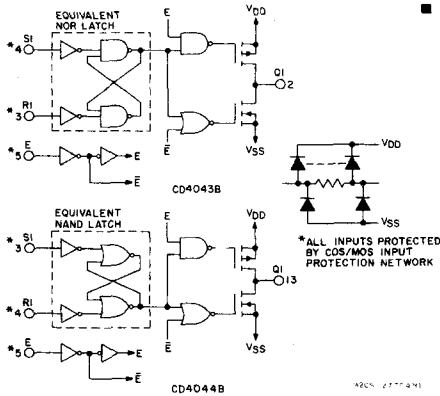
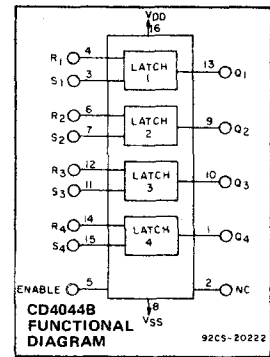
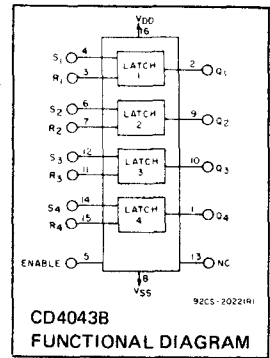

S	R	E	Q
X	X	0	OC*
0	0	1	NC*
1	0	1	1
0	1	1	0
1	1	1	$\Delta$

S	R	E	Q
X	X	0	OC*
1	1	1	NC*
0	1	1	1
1	0	1	0
0	0	1	$\Delta$

\* OPEN CIRCUIT  
 + NO CHANGE  
 $\Delta$  DOMINATED BY S=1 INPUT  
 92CS-20211 CD4043B

\* OPEN CIRCUIT  
 + NO CHANGE  
 $\Delta$  DOMINATED BY R=0 INPUT  
 92CS-20212 CD4044B

### MAXIMUM RATINGS, Absolute-Maximum Values:

DC SUPPLY-VOLTAGE RANGE, ( $V_{DD}$ ) (Voltages referenced to $V_{SS}$ Terminal)	-0.5 to +20 V
INPUT VOLTAGE RANGE, ALL INPUTS	-0.5 to $V_{DD} + 0.5$ V
DC INPUT CURRENT, ANY ONE INPUT	$\pm 10$ mA
POWER DISSIPATION PER PACKAGE ( $P_D$ ):	
For $T_A = -40$ to $+60^\circ\text{C}$ (PACKAGE TYPE E)	500 mW
For $T_A = +60$ to $+85^\circ\text{C}$ (PACKAGE TYPE E)	Derate Linearly at 12 mW/ $^\circ\text{C}$ to 200 mW
For $T_A = -55$ to $+100^\circ\text{C}$ (PACKAGE TYPES D, F, K)	500 mW
For $T_A = +100$ to $+125^\circ\text{C}$ (PACKAGE TYPES D, F, K)	Derate Linearly at 12 mW/ $^\circ\text{C}$ to 200 mW
DEVISSAGE DISSIPATION PER OUTPUT TRANSISTOR:	
For $T_A =$ FULL PACKAGE-TEMPERATURE RANGE (All Package Types)	100 mW
OPERATING-TEMPERATURE RANGE ( $T_A$ ):	
PACKAGE TYPES D, F, K, H	-55 to $+125^\circ\text{C}$
PACKAGE TYPE E	-40 to $+85^\circ\text{C}$
STORAGE TEMPERATURE RANGE ( $T_{stg}$ )	-65 to $+150^\circ\text{C}$
LEAD TEMPERATURE (DURING SOLDERING):	
At distance 1/16 $\pm$ 1/32 inch (1.59 $\pm$ 0.79 mm) from case for 10 s max.	$+265^\circ\text{C}$

### TRUTH TABLES

Recommended Operating Conditions  $T_A = 25^\circ\text{C}$   
 For maximum reliability, nominal operating conditions should be selected so that operation is always within the following ranges.

Characteristic	$V_{DD}$ (V)	Min.	Max.	Units
Supply-Voltage Range ( $T_A =$ Full Package Temperature Range)		3	18	V
SET or RESET Pulse Width, $t_W$	5	160	—	ns
	10	80	—	
	15	40	—	

# CD4043B, CD4044B Types

## STATIC ELECTRICAL CHARACTERISTICS

CHARACTERISTIC	CONDITIONS			LIMITS AT INDICATED TEMPERATURES (°C)							UNITS
	V <sub>O</sub> (V)	V <sub>IN</sub> (V)	V <sub>DD</sub> (V)	Values at -55, +25, +125 Apply to D, F, K, H Packages				Values at -40, +25, +85 Apply to E Package			
				-55	-40	+85	+125	+25			
				Min.	Typ.	Max.					
Quiescent Device Current, I <sub>DD</sub> Max.	-	0,5	5	1	1	30	30	-	0.02	1	μA
	-	0,10	10	2	2	60	60	-	0.02	2	
	-	0,15	15	4	4	120	120	-	0.02	4	
	-	0,20	20	20	20	600	600	-	0.04	20	
Output Low (Sink) Current I <sub>OL</sub> Min.	0.4	0,5	5	0.64	0.61	0.42	0.36	0.51	1	-	mA
	0.5	0,10	10	1.6	1.5	1.1	0.9	1.3	2.6	-	
	1.5	0,15	15	4.2	4	2.8	2.4	3.4	6.8	-	
Output High (Source) Current, I <sub>OH</sub> Min.	4.6	0,5	5	-0.64	-0.61	-0.42	-0.36	-0.51	-1	-	mA
	2.5	0,5	5	-2	-1.8	-1.3	-1.15	-1.6	-3.2	-	
	9.5	0,10	10	-1.6	-1.5	-1.1	-0.9	-1.3	-2.6	-	
	13.5	0,15	15	-4.2	-4	-2.8	-2.4	-3.4	-6.8	-	
Output Voltage: Low-Level, V <sub>OL</sub> Max.	-	0,5	5	0.05				-	0	0.05	V
	-	0,10	10	0.05				-	0	0.05	
	-	0,15	15	0.05				-	0	0.05	
Output Voltage: High-Level, V <sub>OH</sub> Min.	-	0,5	5	4.95				4.95	5	-	V
	-	0,10	10	9.95				9.95	10	-	
	-	0,15	15	14.95				14.95	15	-	
Input Low Voltage, V <sub>IL</sub> Max.	0.5, 4.5	-	5	1.5				-	-	1.5	V
	1, 9	-	10	3				-	-	3	
	1.5, 13.5	-	15	4				-	-	4	
Input High Voltage, V <sub>IH</sub> Min.	0.5, 4.5	-	5	3.5				3.5	-	-	V
	1, 9	-	10	7				7	-	-	
	1.5, 3.5	-	15	11				11	-	-	
Input Current I <sub>IN</sub> Max.	-	0,18	18	±0.1	±0.1	±1	±1	-	±10 <sup>-5</sup>	±0.1	μA
3-State Output Leakage Current I <sub>OUT</sub> Max.	0,18	0,18	18	±0.4	±0.4	±12	±12	-	±10 <sup>-4</sup>	±0.4	μA

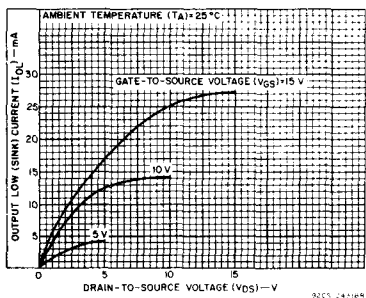

Fig. 2 — Typical output low (sink) current characteristics.

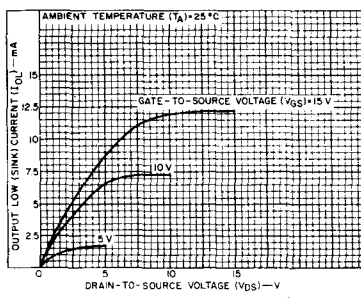

Fig. 3 — Minimum output low (sink) current characteristics.

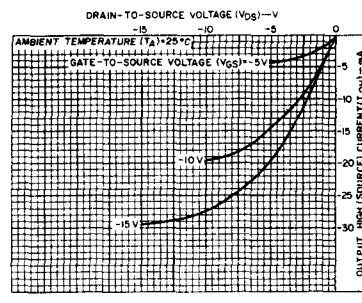

Fig. 4 — Typical output high (sink) current characteristics.

# CD4043B, CD4044B Types

DYNAMIC ELECTRICAL CHARACTERISTICS at  $T_A = 25^\circ\text{C}$ ; Input  $t_r, t_f = 20\text{ ns}$ ,  
 $C_L = 50\text{ pF}$ ,  $R_L = 200\text{ K}\Omega$

CHARACTERISTIC	$V_{DD}$ (V)	LIMITS ALL TYPES		UNITS
		TYP.	MAX.	
Propagation Delay Time: $t_{pHL}, t_{pLH}$ SET or RESET to Q	5	150	300	ns
	10	70	140	
	15	50	100	
3-State Propagation Delay Time: ENABLE to Q $t_{pHZ}, t_{pZH}$	5	115	230	ns
	10	55	110	
	15	40	80	
$t_{PLZ}, t_{PZL}$	5	90	180	ns
	10	50	100	
	15	35	70	
Transition Time: $t_{THL}, t_{TLH}$	5	100	200	ns
	10	50	100	
	15	40	80	
Minimum SET or RESET Pulse Width, $t_W$	5	80	160	ns
	10	40	80	
	15	20	40	
Input Capacitance, (Any Input) $C_{IN}$	—	5	7.5	pF

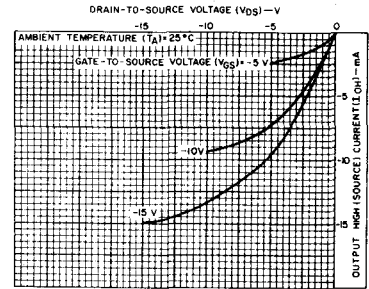

Fig. 5 — Minimum output high (source) current characteristics.

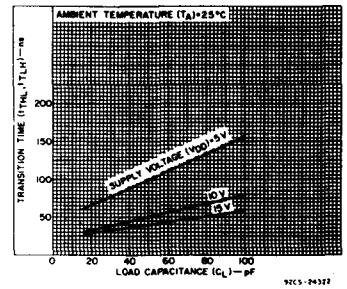

Fig. 6 — Typical transition time vs. load capacitance.

## TEST CIRCUITS

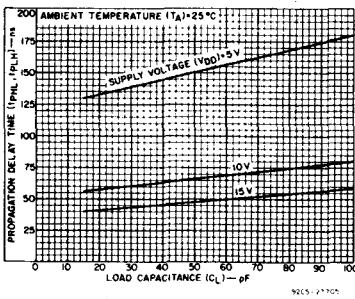

Fig. 7 — Typical propagation delay time vs. load capacitance—SET, RESET to Q, Q.

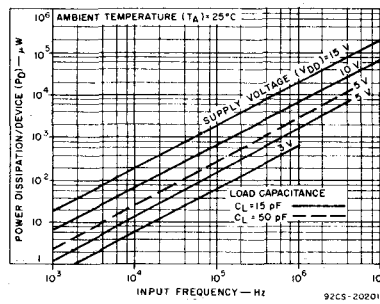

Fig. 8 — Typical power dissipation vs. frequency.

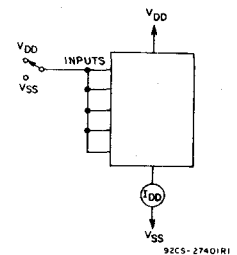

Fig. 9 — Quiescent device current.

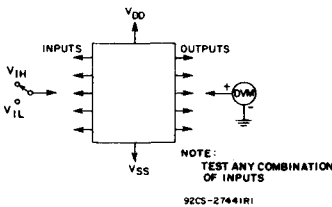

Fig. 10 — Input voltage.

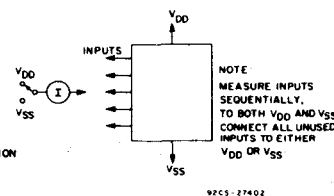

Fig. 11 — Input current.

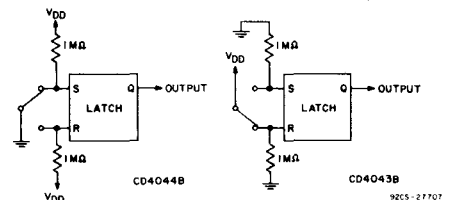

Fig. 12 — Switch bounce eliminator.

# CD4043B, CD4044B Types

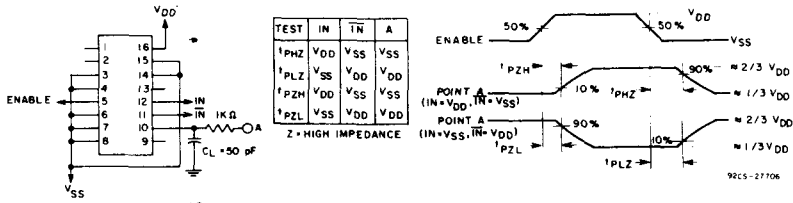
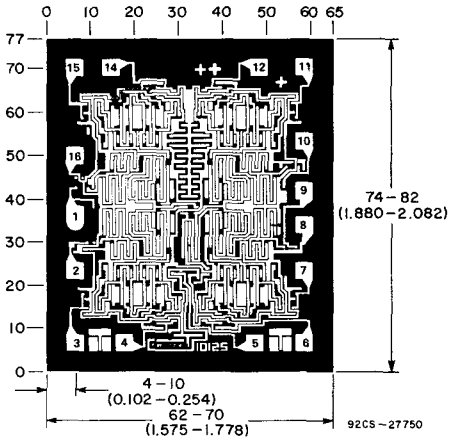
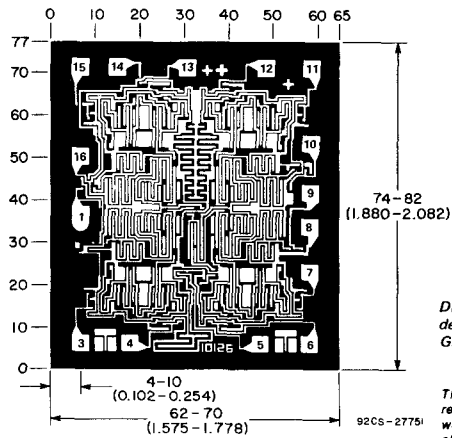

Fig. 13 — ENABLE propagation delay time test circuit and waveforms.

## CHIP PHOTOGRAPHS DIMENSIONS AND PAD LAYOUTS



CD4043BH



CD4044BH

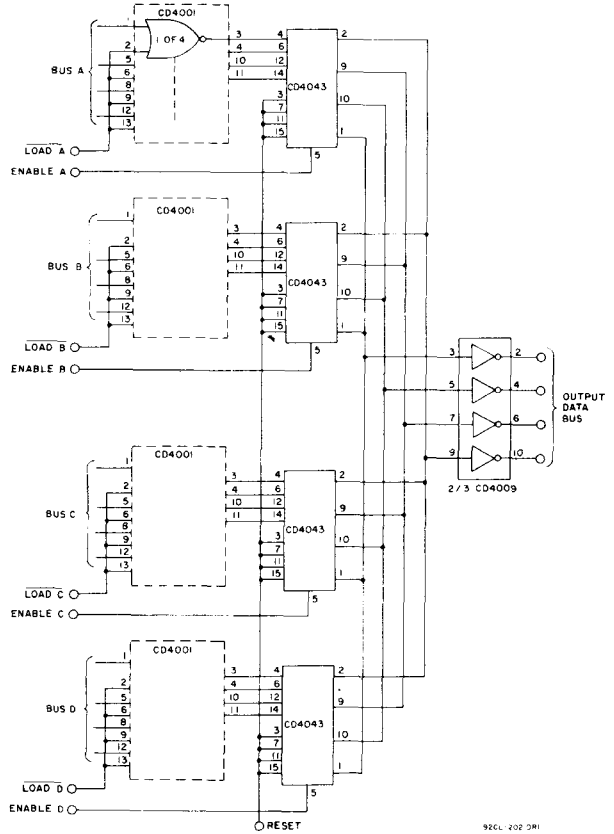

Fig. 14 — Multiple bus storage.

Dimensions in parentheses are in millimeters and are derived from the basic inch dimensions as indicated. Grid graduations are in mils ( $10^{-3}$  inch).

The photographs and dimensions of each CMOS chip represent a chip when it is part of the wafer. When the wafer is separated into individual chips, the angle of cleavage may vary with respect to the chip face for different chips. The actual dimensions of the isolated chip, therefore, may differ slightly from the nominal dimensions shown. The user should consider a tolerance of  $-3$  mils to  $+16$  mils applicable to the nominal dimensions shown.

# CD4045B Types

## CMOS 21-Stage Counter

High-Voltage Types (20-Volt Rating)

The RCA-CD4045B is a timing circuit consisting of 21 counter stages, two output-shaping flip-flops, two inverter output drivers, and input inverters for use in a crystal oscillator. The CD4045B configuration provides 21 flip-flop counting stages, and two flip-flops for shaping the output waveform for a 3.125% duty cycle. Push-pull operation is provided by the inverter output drivers.

The first inverter is intended for use as a crystal oscillator/amplifier. However, it may be used as a normal logic inverter if desired. A crystal oscillator circuit can be made less sensitive to voltage-supply variations by the use of source resistors. In this device, the sources of the p and n transistors have been brought out to package terminals. If external resistors are not required, the sources must be shorted to their respective substrates ( $S_p$  to  $V_{DD}$ ,  $S_n$  to  $V_{SS}$ ). See Fig. 1. The first inverter in conjunction with an outboard inverter, such as 1/6 CD4069, and  $R_X$ ,  $C_X$ , and  $R_S$  can also be used to construct an RC oscillator. The following data is supplied as a guide in the selection of values for  $R_X$ ,  $R_S$ , and  $C_X$  used in Fig. 11:

1.  $R_X$  max = 10 M $\Omega$  with  $R_S$  = 10 M $\Omega$  and  $C_X$  = 50 pF
2.  $C_X$  max = 25  $\mu$ F with  $R_S$  = 560 k $\Omega$  and  $R_X$  = 50 k $\Omega$

The CD4045B types are supplied in 16-lead dual-in-line ceramic packages (D and F suffixes), 16-lead dual-in-line plastic packages (E suffix), 16-lead ceramic flat packages (K suffix), and in chip form (H suffix).

### Applications:

- Digital equipment in which ultra-low dissipation and/or operation using a battery source is required.
- Accurate timing from a crystal oscillator for timing applications such as wall clocks, table clocks, automobile clocks, and digital timing references in any circuit requiring accurately timed outputs at various intervals in the counting sequence.
- Driving miniature synchronous motors, stepping motors, or external bipolar transistors in push-pull fashion.

### Features:

- Very low operating dissipation . . . . . <1 mW (typ.) @  $V_{DD}$  = 5 V,  $f\phi$  = 1 MHz
- Output drivers with sink or source capability . . . . . 7 mA (typ.) @  $V_{DD}$  = 5 V
- Medium speed (typ.) . . . . .  $f\phi$  = 25 MHz @  $V_{DD}$  = 10 V
- 100% tested for quiescent current at 20 V
- 5-V, 10-V, and 15-V parametric ratings
- Meets all requirements of JEDEC Tentative Standard No. 13A, Standard Specifications for Descriptor of 'B' Series CMOS Devices"

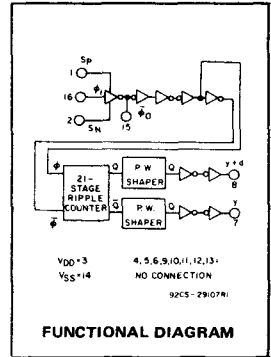

### MAXIMUM RATINGS, Absolute-Maximum Values:

DC SUPPLY-VOLTAGE RANGE, ( $V_{DD}$ ) (Voltages referenced to $V_{SS}$ Terminal)	-0.5 to +20 V
INPUT VOLTAGE RANGE, ALL INPUTS	-0.5 to $V_{DD}$ +0.5 V
DC INPUT CURRENT, ANY ONE INPUT	$\pm$ 10 mA
POWER DISSIPATION PER PACKAGE ( $P_D$ ):	
For $T_A$ = -40 to +60°C (PACKAGE TYPE E)	500 mW
For $T_A$ = +60 to +85°C (PACKAGE TYPE E)	Derate Linearly at 12 mW/°C to 200 mW
For $T_A$ = -55 to +100°C (PACKAGE TYPES D, F, K)	500 mW
For $T_A$ = +100 to +125°C (PACKAGE TYPES D, F, K)	Derate Linearly at 12 mW/°C to 200 mW
DEVICE DISSIPATION PER OUTPUT TRANSISTOR	
FOR $T_A$ = FULL PACKAGE-TEMPERATURE RANGE (All Package Types)	100 mW
OPERATING-TEMPERATURE RANGE ( $T_A$ ):	
PACKAGE TYPES D, F, K, H	-55 to +125°C
PACKAGE TYPE E	-40 to +85°C
STORAGE TEMPERATURE RANGE ( $T_{stg}$ )	-65 to +150°C
LEAD TEMPERATURE (DURING SOLDERING):	
At distance 1/16 $\pm$ 1/32 inch (1.59 $\pm$ 0.79 mm) from case for 10 s max.	+265°C

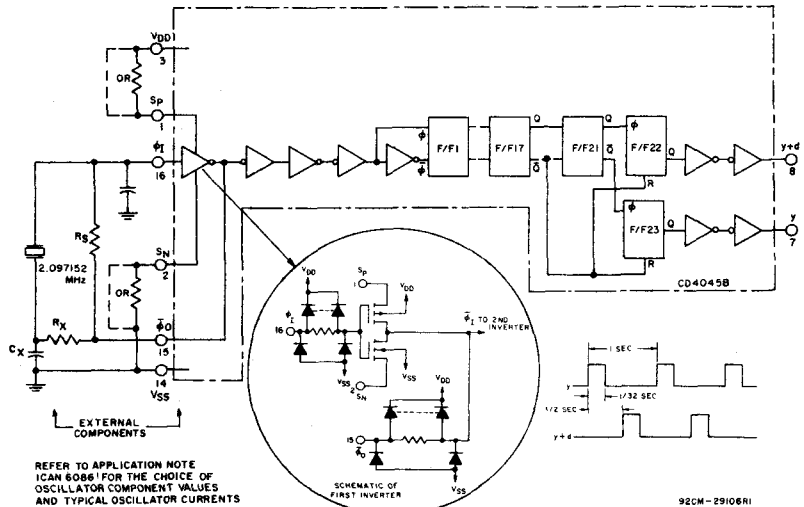

Fig. 1 - CD4045B and outboard components in a typical 21-stage counter application.

STATIC ELECTRICAL CHARACTERISTICS

CHARACTERISTIC	CONDITIONS			LIMITS AT INDICATED TEMPERATURES (°C)							UNITS	
	V <sub>O</sub> (V)	V <sub>IN</sub> (V)	V <sub>DD</sub> (V)	Values at -55, +25, +125 Apply to D, F, K, H Packages				Values at -40, +25, +85, Apply to E Package				
				-55	-40	+85	+125	+25				
								Min.	Typ.	Max.		
Quiescent Device Current, I <sub>DD</sub> Max.	-	0,5	5	5	5	150	150	-	0.04	5	μA	
	-	0,10	10	10	10	300	300	-	0.04	10		
	-	0,15	15	20	20	600	600	-	0.04	20		
	-	0,20	20	100	100	3000	3000	-	0.08	100		
Output Low (Sink) Current I <sub>OL</sub> Min.	0.4	0,5	5	4.5	4.3	2.9	2.5	3.6	7	-	mA	
	0.5	0,10	10	11.2	10.5	7.7	6.3	9.1	18	-		
	1.5	0,15	15	29.4	28	19.6	16.8	23.8	47	-		
Output High (Source) Current, I <sub>OH</sub> Min.	4.6	0,5	5	-4.5	-4.3	-2.9	-2.5	-3.6	-7	-	mA	
	9.5	0,10	10	-11.2	-10.5	-7.7	-6.3	-9.1	-18	-		
	13.5	0,15	15	-29.4	-28	-19.6	-16.8	-23.8	-47	-		
Pin 15 Output Low and High Current, I <sub>OL</sub> , I <sub>OH</sub>	0.4, 4.6	0,5	5	-				±0.1	±0.18	-	mA	
	0.5, 9.5	0,10	10	-				±0.2	±0.3	-		
Output Voltage: Low-Level, V <sub>OL</sub> Max.	-	0,5	5	-				-	-	0.05	V	
	-	0,10	10	-				-	-	0.05		
	-	0,15	15	-				-	-	0.05		
Output Voltage: High-Level, V <sub>OH</sub> Min.	-	0,5	5	-				4.95	4.95	5	V	
	-	0,10	10	-				9.95	9.95	10		
	-	0,15	15	-				14.95	14.95	15		
Input Low Voltage, V <sub>IL</sub> Max.	0.5, 4.5	-	5	-				1.5	-	-	1.5	V
	1,9	-	10	-				3	-	-	3	
	1.5, 13.5	-	15	-				4	-	-	4	
Input High Voltage, V <sub>IH</sub> Min.	0.5, 4.5	-	5	-				3.5	3.5	-	-	V
	1,9	-	10	-				7	7	-	-	
	1.5, 13.5	-	15	-				11	11	-	-	
Input Current I <sub>IN</sub> Max.	-	0,18	18	±0.1	±0.1	±1	±1	-	±10 <sup>-5</sup>	±0.1	μA	

RECOMMENDED OPERATING CONDITIONS

For maximum reliability, nominal operating conditions should be selected so that operation is always within the following ranges

CHARACTERISTIC	V <sub>DD</sub> (V)	LIMITS		UNITS
		Min.	Max.	
Supply-Voltage Range (For T <sub>A</sub> = Full Package-Temperature Range)	-	3	18	V
Minimum Input-Pulse Width, t <sub>w</sub>	5	-	100	ns
	10	-	50	
	15	-	40	
Maximum Input-Pulse Frequency, f <sub>φ</sub> (External Pulse Source)	5	5	-	MHz
	10	12	-	
	15	15	-	

# CD4045B Types

**DYNAMIC ELECTRICAL CHARACTERISTICS at  $T_A = 25^\circ\text{C}$ ; Input  $t_r, t_f = 20 \text{ ns}$ ,  $C_L = 50 \text{ pF}$ ,  $R_L = 200 \text{ k}\Omega$**

CHARACTERISTIC	TEST CONDITIONS	$V_{DD}$ V	LIMITS			UNITS
			Min.	Typ.	Max.	
Propagation Delay Time: $\phi_1$ to y or y+d out $t_{PHL}, t_{PLH}$		5	—	2.2	5.5	$\mu\text{s}$
		10	—	0.9	2.7	
		15	—	0.65	2	
Transition Time: $t_{THL}, t_{TLH}$		5	—	25	50	ns
		10	—	13	25	
		15	—	10	20	
Minimum Input-Pulse Width $t_W$		5	—	50	100	
		10	—	25	50	
		15	—	20	40	
Input-Pulse Rise or Fall Time: $t_r\phi, t_f\phi$		5	—	—	500	$\mu\text{s}$
		10	—	—	500	
		15	—	—	500	
Maximum Input-Pulse Frequency: (External Pulse Source) $f_\phi$		5	5	10	—	MHz
		10	12	25	—	
		15	15	30	—	
Input Capacitance, $C_{IN}$	Any Input		—	5	7.5	pF
Variation of Output Frequency (Unit-to-Unit)	$f = 5 \text{ MHz}$	5	—	0.05	—	%
		10	—	0.03	—	
		15	—	0.1	—	
<b>RC Oscillator Operation</b>						
Maximum Oscillator Frequency (See Fig. 11) $f_{osc}$	$R_X = 50 \text{ k}\Omega$ ,	5	45	60	75	kHz
	$R_S = 560 \text{ k}\Omega$ ,	10	45	60	75	
	$C_X = 50 \text{ pF}$	15	45	60	75	

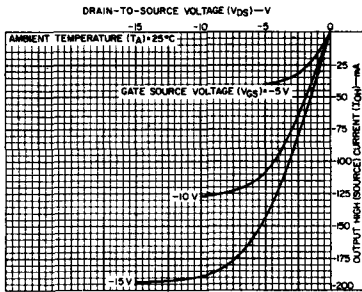

Fig. 4 - Typical output high (source) current characteristics.

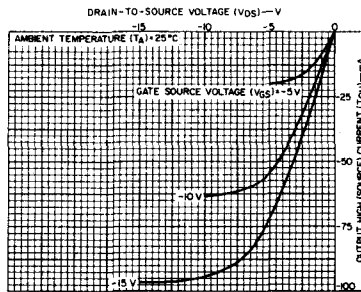

Fig. 5 - Minimum output high (source) characteristics.

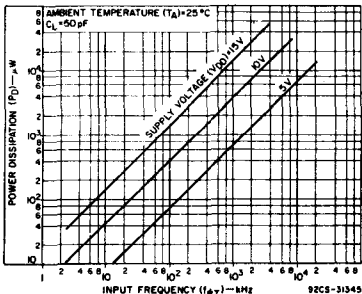

Fig. 7 - Typical power dissipation as a function of input frequency (21 counting stages).

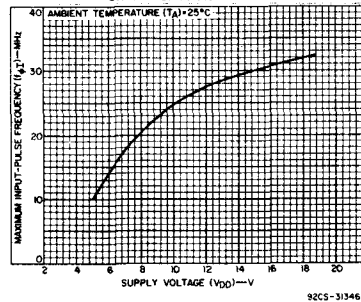

Fig. 8 - Typical maximum input-pulse frequency as a function of supply voltage.

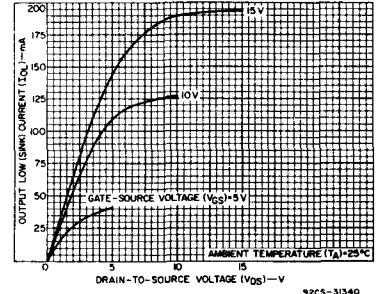

Fig. 2 - Typical output low (sink) current characteristics.

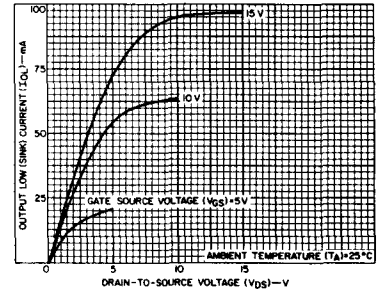

Fig. 3 - Minimum output low (sink) current characteristics.

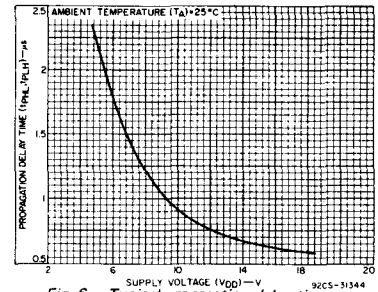

Fig. 6 - Typical propagation delay time as a function of supply voltage ( $\phi_1$  to y or y + d out vs.  $V_{DD}$ ).

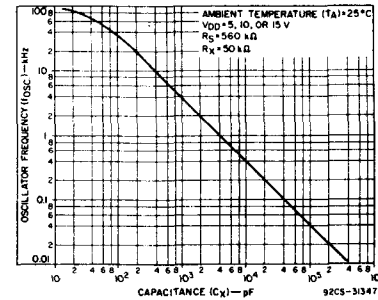

Fig. 9 - Typical RC oscillator frequency as a function of capacitance ( $C_X$ ). See Fig. 11.



# CD405B Types

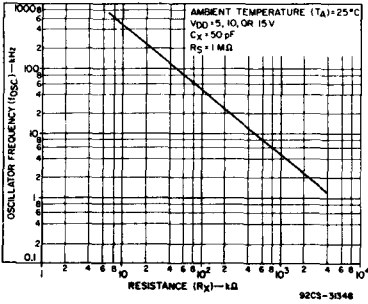

Fig. 10 - Typical RC oscillator frequency as a function of resistance ( $R_X$ ). See Fig. 11.

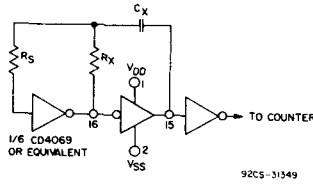

Fig. 11 - Typical RC circuit.

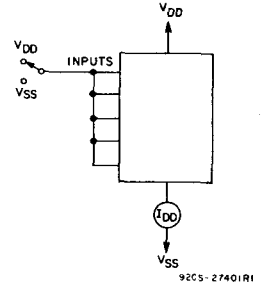

Fig. 12 - Quiescent device current test circuit.

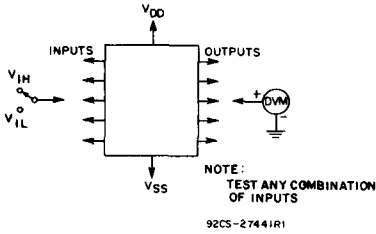

Fig. 13 - Noise-immunity test circuit.

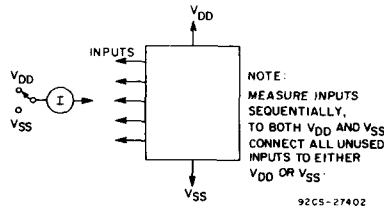

Fig. 14 - Input-leakage-current test circuit.

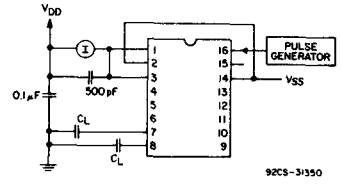
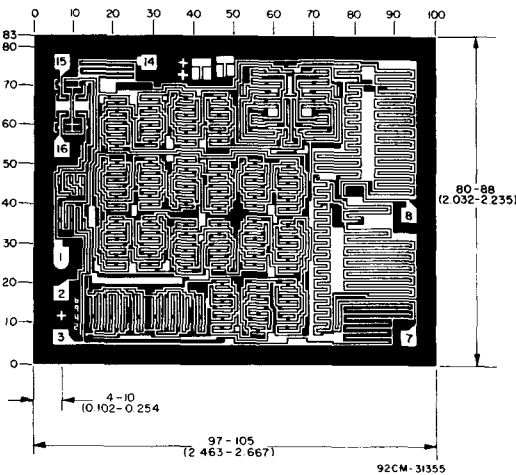

Fig. 15 - Dynamic power dissipation test circuit.



Dimensions and pad layout for CD405B.

Dimensions in parentheses are in millimeters and are derived from the basic inch dimensions as indicated. Grid graduations are in mils ( $10^{-3}$  inch).

The photographs and dimensions of each CMOS chip represent a chip when it is part of the wafer. When the wafer is separated into individual chips, the angle of cleavage may vary with respect to the chip face for different chips. The actual dimensions of the isolated chip, therefore, may differ slightly from the nominal dimensions shown. The user should consider a tolerance of  $-3$  mils to  $+16$  mils applicable to the nominal dimensions shown.

## TERMINAL DIAGRAM Top View

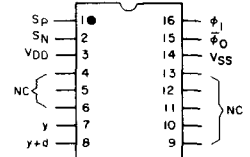

92CS-24478R2

NC - NO CONNECTION

**NOTE** Observe power-supply terminal connections,  $V_{DD}$  is terminal No. 3 and  $V_{SS}$  is terminal No. 14 (not 16 and 8 respectively, as in other CD4000B Series 16-lead devices).

# CD4046B Types

## CMOS Micropower Phase-Locked Loop

The RCA-CD4046B CMOS Micropower Phase-Locked Loop (PLL) consists of a low-power, linear voltage-controlled oscillator (VCO) and two different phase comparators having a common signal-input amplifier and a common comparator input. A 5.2-V zener diode is provided for supply regulation if necessary.

The CD4046B types are supplied in 16-lead ceramic dual-in-line packages (D and F suffixes), 16-lead dual-in-line plastic packages (E suffix), 16-lead ceramic flat packages (K suffix), and in chip form (H suffix).

### VCO Section

The VCO requires one external capacitor C1 and one or two external resistors (R1 or R1 and R2). Resistor R1 and capacitor C1 determine the frequency range of the VCO and resistor R2 enables the VCO to have a frequency offset if required. The high input impedance ( $10^{12}\Omega$ ) of the VCO simplifies the design of low-pass filters by permitting the designer a wide choice of resistor-to-capacitor ratios. In order not to load the low-pass filter, a source-follower output of the VCO input voltage is provided at terminal 10 (DEMODULATED OUTPUT). If this terminal is used, a load resistor ( $R_S$ ) of 10 k $\Omega$  or more should be connected from this terminal to VSS. If unused this terminal should be left open. The VCO can be connected either directly or through frequency dividers to the comparator input of the phase comparators. A full COS/MOS logic swing is available at the output of the VCO and allows direct coupling to COS/MOS frequency dividers such as the RCA-CD4024, CD4018, CD4020, CD4022, CD4029, and CD4059. One or more CD4018 (Presettable Divide-by-N Counter) or CD4029 (Presettable Up/Down Counter), or CD4059A (Programmable Divide-by-"N" Counter), together with the CD4046B (Phase-Locked Loop) can be used to build a micropower low-frequency synthesizer. A logic 0 on the INHIBIT input "enables" the VCO and the source follower, while a logic 1 "turns off" both to minimize stand-by power consumption.

### MAXIMUM RATINGS, Absolute-Maximum Values:

DC SUPPLY-VOLTAGE RANGE, ( $V_{DD}$ )	
(Voltages referenced to $V_{SS}$ Terminal)	-0.5 to +20 V
INPUT VOLTAGE RANGE, ALL INPUTS	-0.5 to $V_{DD} + 0.5$ V
DC INPUT CURRENT, ANY ONE INPUT	$\pm 10$ mA
POWER DISSIPATION PER PACKAGE ( $P_D$ ):	
For $T_A = -40$ to $+60^\circ\text{C}$ (PACKAGE TYPE E)	500 mW
For $T_A = +60$ to $+85^\circ\text{C}$ (PACKAGE TYPE E)	Derate Linearly at 12 mW/ $^\circ\text{C}$ to 200 mW
For $T_A = -55$ to $+100^\circ\text{C}$ (PACKAGE TYPES D, F, K)	500 mW
For $T_A = +100$ to $+125^\circ\text{C}$ (PACKAGE TYPES D, F, K)	Derate Linearly at 12 mW/ $^\circ\text{C}$ to 200 mW
DEVICE DISSIPATION PER OUTPUT TRANSISTOR	
For $T_A = \text{FULL PACKAGE-TEMPERATURE RANGE (All Package Types)}$	100 mW
OPERATING-TEMPERATURE RANGE ( $T_A$ ):	
PACKAGE TYPES D, F, K, H	-55 to $+125^\circ\text{C}$
PACKAGE TYPE E	-40 to $+85^\circ\text{C}$
STORAGE TEMPERATURE RANGE ( $T_{stg}$ )	-65 to $+150^\circ\text{C}$
LEAD TEMPERATURE (DURING SOLDERING):	
At distance 1/16 $\pm$ 1/32 inch (1.59 $\pm$ 0.79 mm) from case for 10 s max.	$+265^\circ\text{C}$

### Features:

- Very low power consumption: 70  $\mu\text{W}$  (typ.) at VCO  $f_o = 10$  kHz,  $V_{DD} = 5$  V
- Operating frequency range up to 1.4 MHz (typ.) at  $V_{DD} = 10$  V,  $R_I = 5$  k $\Omega$
- Low frequency drift: 0.04%/ $^\circ\text{C}$  (typ.) at  $V_{DD} = 10$  V
- Choice of two phase comparators: Exclusive-OR network (I) Edge-controlled memory network with phase-pulse output for lock indication (II)
- High VCO linearity: <1% (typ.) at  $V_{DD} = 10$  V
- VCO inhibit control for ON-OFF keying and ultra-low standby power consumption
- Source-follower output of VCO control input (Demod. output)
- Zener diode to assist supply regulation
- Standardized, symmetrical output characteristics
- 100% tested for quiescent current at 20 V
- 5-V, 10-V, and 15-V parametric ratings
- Meets all requirements of JEDEC Tentative Standard No. 13A, "Standard Specifications for Description of 'B' Series CMOS Devices"

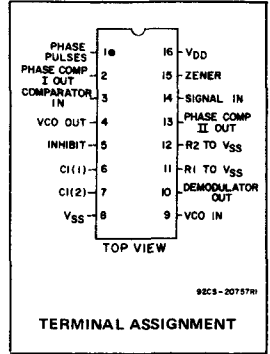

### Applications:

- FM demodulator and modulator
- Frequency synthesis and multiplication
- Frequency discriminator
- Data synchronization
- Voltage-to-frequency conversion
- Tone decoding
- FSK - Modems
- Signal conditioning
- (See ICAN-6101) "RCA COS/MOS Phase-Locked Loop - A Versatile Building Block for Micropower Digital and Analog Applications"

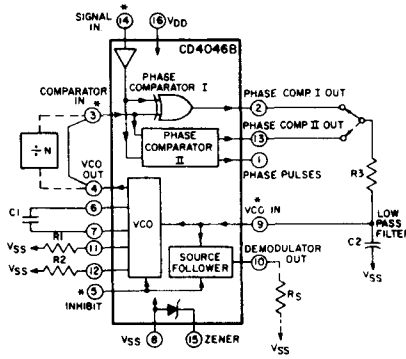
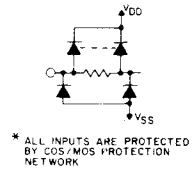

Fig.1 - COS/MOS phase-locked loop block diagram.



\* ALL INPUTS ARE PROTECTED BY COS/MOS PROTECTION NETWORK

92CS-29172

### Phase Comparators

The phase-comparator signal input (terminal 14) can be direct-coupled provided the signal swing is within COS/MOS logic levels [logic "0"  $\leq 30\%$  ( $V_{DD}-V_{SS}$ ), logic "1"  $\geq 70\%$  ( $V_{DD}-V_{SS}$ )]. For smaller swings the signal must be capacitively coupled to the self-biasing amplifier at the signal input. Phase comparator I is an exclusive-OR network; it operates analogously to an over-driven balanced mixer. To maximize the lock range, the signal- and comparator-input frequencies must have a 50% duty cycle. With no signal or noise on the signal input, this phase comparator has an average output voltage equal to  $V_{DD}/2$ . The low-pass filter connected to the output of phase comparator

# CD4046B Types

**RECOMMENDED OPERATING CONDITIONS AT  $T_A$  = Full Package-Temperature Range**  
**For maximum reliability, nominal operating conditions should be selected so that operation is always within the following ranges:**

CHARACTERISTIC	LIMITS		UNITS
	Min.	Max.	
Supply-Voltage Range VCO Section: As Fixed Oscillator Phased-Lock-Loop Operation	3	18	V
Supply-Voltage Range Phase Comparator Section: Comparators VCO Operation	3	18	

## DESIGN INFORMATION

This information is a guide for approximating the values of external components for the CD4046A in a Phase-Locked-Loop system.

The selected external components must be within the following ranges:

$$5 \text{ k}\Omega \leq R_1, R_2, R_S \leq 1 \text{ M}\Omega$$

$$C_1 \geq 100 \text{ pF at } V_{DD} \geq 5 \text{ V;}$$

$$C_1 \geq 50 \text{ pF at } V_{DD} \geq 10 \text{ V}$$

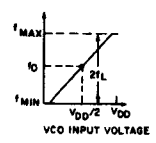
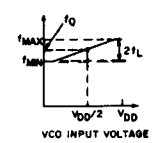
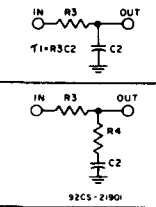
Characteristics	Phase Comparator Used	Design Information	
		VCO WITHOUT OFFSET $R_2 = \infty$	VCO WITH OFFSET
VCO Frequency	1		
	2	Same as for No.1	
For No Signal Input	1	VCO will adjust to center frequency, $f_0$	
	2	VCO will adjust to lowest operating frequency, $f_{min}$	
Frequency Lock Range, $2f_L$	1	$2f_L = \text{full VCO frequency range}$ $2f_L = f_{max} - f_{min}$	
	2	Same as for No.1	
Frequency Capture Range, $2f_C$	1	 $2f_C \approx \frac{1}{\pi} \sqrt{\frac{2\pi f_L}{\tau_1}}$	
Loop Filter Component Selection	2	$f_C = f_L$	
Phase Angle Between Signal and Comparator	1	$90^\circ$ at center frequency ( $f_0$ ) approximating $0^\circ$ and $180^\circ$ at ends of lock range ( $2f_L$ )	
	2	Always $0^\circ$ in lock	
Locks On Harmonic of Center Frequency	1	Yes	
	2	No	
Signal Input Noise Rejection	1	High	
	2	Low	

For further information, see

- F. Gardner, "Phase-Lock Techniques" John Wiley and Sons, New York, 1966
- G. S. Moschytz, "Miniaturized RC Filters Using Phase-Locked Loop", BSTJ, May, 1965.

I supplies the averaged voltage to the VCO input, and causes the VCO to oscillate at the center frequency ( $f_0$ ).

The frequency range of input signals on which the PLL will lock if it was initially out of lock is defined as the frequency capture range ( $2f_C$ ).

The frequency range of input signals on which the loop will stay locked if it was initially in lock is defined as the frequency lock range ( $2f_L$ ). The capture range is  $\leq$  the lock range.

With phase comparator I the range of frequencies over which the PLL can acquire lock (capture range) is dependent on the low-pass-filter characteristics, and can be made as large as the lock range. Phase-comparator I enables a PLL system to remain in lock in spite of high amounts of noise in the input signal.

One characteristic of this type of phase comparator is that it may lock onto input frequencies that are close to harmonics of the VCO center-frequency. A second characteristic is that the phase angle between the signal and the comparator input varies between  $0^\circ$  and  $180^\circ$ , and is  $90^\circ$  at the center frequency. Fig. 2 shows the typical, triangular, phase-to-output response characteristic of phase-comparator I. Typical waveforms for a CMOS phase-locked-loop employing phase comparator I in locked condition of  $f_0$  is shown in Fig. 3.

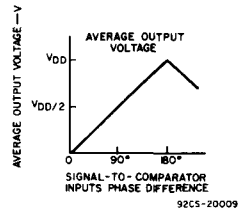

Fig. 2 — Phase-comparator I characteristics at low-pass filter output.

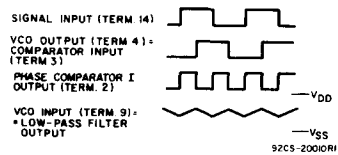

Fig. 3 — Typical waveforms for CMOS phase-locked loop employing phase comparator in locked condition of  $f_0$ .

Phase-comparator II is an edge-controlled digital memory network. It consists of four flip-flop stages, control gating, and a three-state output circuit comprising p- and n-type drivers having a common output node. When the p-MOS or n-MOS drivers are ON they pull the output up to  $V_{DD}$  or down to  $V_{SS}$ , respectively. This type of phase comparator acts only on the positive edges of the signal and comparator inputs. The duty cycles of the signal and comparator inputs are not important since positive transitions

# CD4046B Types

## STATIC ELECTRICAL CHARACTERISTICS

CHARACTERISTIC	CONDITIONS			LIMITS AT INDICATED TEMPERATURE (°C)							UNIT
				Values at -55, +25, +125 Apply to D, F, K, H Packages Values at -40, +25, +85 Apply to E Package							
	V <sub>O</sub> (V)	V <sub>IN</sub> (V)	V <sub>DD</sub> (V)	-55	-40	+85	+125	+25			
							Min.	Typ.	Max.		
<b>VCO Section</b>											
Output Low (Sink) Current I <sub>OL</sub> Min.	0.4	0.5	5	0.64	0.61	0.42	0.36	0.51	1	-	mA
	0.5	0.10	10	1.6	1.5	1.1	0.9	1.3	2.6	-	
	1.5	0.15	15	4.2	4	2.8	2.4	3.4	6.8	-	
Output High (Source) Current, I <sub>OH</sub> Min.	4.6	0.5	5	-0.64	-0.61	-0.42	-0.36	-0.51	-1	-	mA
	2.5	0.5	5	-2	-1.8	-1.3	-1.15	-1.6	-3.2	-	
	9.5	0.10	10	-1.6	-1.5	-1.1	-0.9	-1.3	-2.6	-	
	13.5	0.15	15	-4.2	-4	-2.8	-2.4	-3.4	-6.8	-	
Output Voltage: Low-Level, V <sub>OL</sub> Max.	Term. 4 driving CMOS	0.5	5	0.05			-	0	0.05	V	
		0.10	10	0.05			-	0			
		0.15	15	0.05			-	0			
Output Voltage: High-Level, V <sub>OH</sub> Min.	e.g. Term. 3	0.5	5	4.95			4.95	5	-	V	
		0.10	10	9.95			9.95	10	-		
		0.15	15	14.95			14.95	15	-		
Input Current I <sub>IN</sub> Max.	-	0.18	18	±0.1	±0.1	±1	±1	-	±10 <sup>-5</sup>	±0.1	μA
<b>Phase Comparator Section</b>											
Total Device Current, I <sub>DD</sub> Max. Term. 14 open, Term. 5 = V <sub>DD</sub>	-	0.5	5	0.2			-	0.1	0.2	mA	
	-	0.10	10	1			-	0.5	1		
	-	0.15	15	1.5			-	0.75	1.5		
	-	0.20	20	4			-	2	4		
Term. 14 = V <sub>SS</sub> or V <sub>DD</sub> , Term. 5 = V <sub>DD</sub>	-	0.5	5	20			-	10	20	μA	
	-	0.10	10	40			-	20	40		
	-	0.15	15	80			-	40	80		
	-	0.20	20	160			-	80	160		
Output Low (Sink) Current I <sub>OL</sub> Min.	0.4	0.5	5	0.64	0.61	0.42	0.36	0.51	1	-	mA
	0.5	0.10	10	1.6	1.5	1.1	0.9	1.3	2.6	-	
	1.5	0.15	15	4.2	4	2.8	2.4	3.4	6.8	-	
Output High (Source) Current I <sub>OH</sub> Min.	4.6	0.5	5	-0.64	-0.61	-0.42	-0.36	-0.51	-1	-	mA
	2.5	0.5	5	-2	-1.8	-1.3	-1.15	-1.6	-3.2	-	
	9.5	0.10	10	-1.6	-1.5	-1.1	-0.9	-1.3	-2.6	-	
	13.5	0.15	15	-4.2	-4	-2.8	-2.4	-3.4	-6.8	-	
DC-Coupled Signal Input and Comparator Input Voltage Sensitivity	0.5, 4.5	-	5	1.5			-	-	1.5	V	
	1.9	-	10	3			-	-	3		
	1.5, 13.5	-	15	4			-	-	4		
	0.5, 4.5	-	5	3.5			3.5	-	-		
	1.9	-	10	7			7	-	-		
	1.5, 13.5	-	15	11			11	-	-		

control the PLL system utilizing this type of comparator. If the signal-input frequency is higher than the comparator-input frequency, the p-type output driver is maintained ON most of the time, and both the n and p drivers OFF (3 state) the remainder

of the time. If the signal-input frequency is lower than the comparator-input frequency, the n-type output driver is maintained ON most of the time, and both the n and p drivers OFF (3 state) the remainder of the time. If the signal- and comparator-

input frequencies are the same, but the signal input lags the comparator input in phase, the n-type output driver is maintained ON for a time corresponding to the phase difference. If the signal- and comparator-input frequencies are the same, but

## STATIC ELECTRICAL CHARACTERISTICS

CHARACTERISTIC	CONDITIONS		LIMITS AT INDICATED TEMPERATURE (°C)						UNITS		
			Values at -55, +25, +125 Apply to D, F, K, H Packages								
			Values at -40, +25, +85 Apply to E Package								
V <sub>O</sub> (V)	V <sub>IN</sub> (V)	V <sub>DD</sub> (V)	-55	-40	+85	+125	+25				
Phase Comparator Section (cont'd)											
Input Current I <sub>IN</sub> Max. (except Term.14)	-	0,18	18	±0.1	±0.1	±1	±1	-	±10 <sup>-5</sup>	±0.1	μA
3-State Leakage Current, I <sub>OUT</sub> Max.	0,18	0,18	18	±0.1	±0.1	±0.2	±0.2	-	±10 <sup>-5</sup>	±0.1	μA

\*Limit determined by minimum feasible leakage current measurement for automatic testing.

## ELECTRICAL CHARACTERISTICS at T<sub>A</sub> = 25°C

CHARACTERISTIC	TEST CONDITIONS		V <sub>DD</sub> (V)	LIMITS			UNITS
				ALL TYPES			
				Min.	Typ.	Max.	
<b>VCO Section</b>							
Operating Power Dissipation, P <sub>D</sub>	f <sub>o</sub> = 10 kHz R <sub>2</sub> = ∞	R <sub>1</sub> = 1 MΩ VCO <sub>IN</sub> = $\frac{V_{DD}}{2}$	5 10 15	- - -	70 800 3000	140 1600 6000	μW
Maximum Operating Frequency f <sub>max</sub>	C <sub>1</sub> = 50 pF R <sub>2</sub> = ∞ VCO <sub>IN</sub> = V <sub>DD</sub>	R <sub>1</sub> = 10 kΩ	5 10 15	0.3 0.6 0.8	0.6 1.2 1.6	- - -	MHz
	C <sub>1</sub> = 50 pF R <sub>2</sub> = ∞ VCO <sub>IN</sub> = V <sub>DD</sub>	R <sub>1</sub> = 5 kΩ	5 10 15	0.5 1 1.4	0.8 1.4 2.4	- - -	
Center Frequency (f <sub>o</sub> ) and Frequency Range (f <sub>max</sub> -f <sub>min</sub> )	Programmable with external components R <sub>1</sub> , R <sub>2</sub> , and C <sub>1</sub> See Design Information						
Linearity	VCO <sub>IN</sub> = 2.5 V ± 0.3 V, R <sub>1</sub> = 10 kΩ		5 10 10 15	- - - -	1.7 0.5 4 0.5	- - - -	%
	= 5 V ± 1 V, = 100 kΩ		10	-	0.5	-	
	= 5 V ± 2.5 V, = 400 kΩ		10	-	4	-	
	= 7.5 V ± 1.5 V, = 100 kΩ		15	-	0.5	-	
	= 7.5 V ± 5 V, = 1 MΩ		15	-	7	-	
Temperature-Frequency Stability: No Frequency Offset f <sub>MIN</sub> = 0			5 10 15	- - -	±0.12 ±0.04 ±0.015	- - -	%/°C
Frequency Offset f <sub>MIN</sub> ≠ 0			5 10 15	- - -	±0.09 ±0.07 ±0.03	- - -	%/°C
Output Duty Cycle			5,10,15	-	50	-	%
Output Transition Times, t <sub>THL</sub> , t <sub>TLH</sub>			5 10 15	- - -	100 50 40	200 100 80	ns

the comparator input lags the signal in phase, the p-type output driver is maintained ON for a time corresponding to the phase difference. Subsequently, the capacitor voltage of the low-pass filter connected to this phase comparator is adjusted until the signal and comparator inputs are equal in both phase and frequency. At this stable point both p- and n-type output drivers remain OFF and thus the phase comparator output becomes an open circuit and holds the voltage on the capacitor of the low-pass filter constant. Moreover the signal at the "phase pulses" output is a high level which can be used for indicating a locked condition. Thus, for phase comparator II, no phase difference exists between signal and comparator input over the full VCO frequency range. Moreover, the power dissipation due to the low-pass filter is reduced when this type of phase comparator is used because both the p- and n-type output drivers are OFF for most of the signal input cycle. It should be noted that the PLL lock range for this type of phase comparator is equal to the capture range, independent of the low-pass filter. With no signal present at the signal input, the VCO is adjusted to its lowest frequency for phase comparator II. Fig. 10 shows typical waveforms for a CMOS PLL employing phase comparator II in a locked condition.

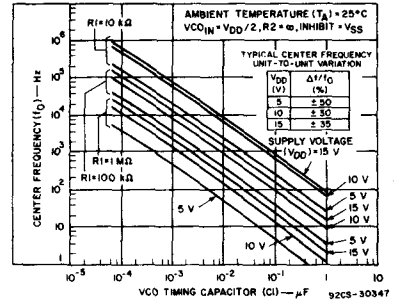

Fig. 4 - Typical center frequency as a function of C<sub>1</sub> and R<sub>1</sub> at V<sub>DD</sub> = 5 V, 10 V, and 15 V.

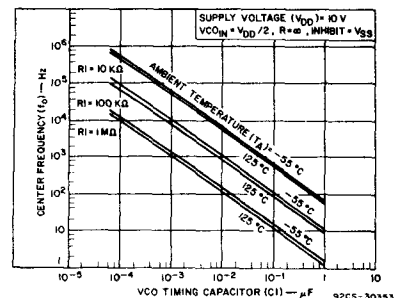

Fig. 5 - Center frequency as a function of C<sub>1</sub> and R<sub>1</sub> for ambient temperatures of -55°C to 125°C.

# CD4046B Types

## ELECTRICAL CHARACTERISTICS at $T_A = 25^\circ\text{C}$

CHARACTERISTIC	TEST CONDITIONS	$V_{DD}$ (V)	LIMITS			UNITS	
			ALL TYPES				
			Min.	Typ.	Max.		
<b>VCO Section (cont'd)</b>							
Source-Follower Output (Demodulated Output): Offset Voltage ( $V_{COIN} - V_{DEM}$ )	$R_S > 10\text{ k}\Omega$	5	—	1.8	2.5	V	
		10	—	1.8	2.5		
		15	—	1.8	2.5		
Linearity	$R_S = 100\text{ k}\Omega$ $= 300\text{ k}\Omega$ $= 500\text{ k}\Omega$	$V_{COIN} = 2.5 \pm 0.3\text{ V}$	5	—	0.3	—	%
		$= 5 \pm 2.5\text{ V}$	10	—	0.7	—	
		$= 7.5 \pm 5\text{ V}$	15	—	0.9	—	
Zener Diode Voltage ( $V_Z$ )	$I_Z = 50\text{ }\mu\text{A}$		4.45	5.5	6.15	V	
Zener Dynamic Resistance, $R_Z$	$I_Z = 1\text{ mA}$		—	40	—	$\Omega$	
<b>Phase Comparator Section</b>							
Term. 14 (SIGNAL IN) Input Resistance $R_{14}$		5 10 15	1 0.2 0.1	2 0.4 0.2	— — —	$M\Omega$	
AC Coupled Signal Input Voltage Sensitivity* (peak-to-peak)	$f_{IN} = 100\text{ kHz}$ , sine wave	5 10 15	— — —	180 330 900	360 660 1800	mV	
Propagation Delay Times, Terms. 14 to 13: High to Low Level, $t_{PHL}$		5 10 15	— — —	225 100 65	450 200 130	ns	
	Low to High Level, $t_{PLH}$	5 10 15	— — —	350 150 100	700 300 200	ns	
		3-State Propagation Delay Times, Terms. 14 to 13: High Level to High Impedance, $t_{PHZ}$	5 10 15	— — —	225 100 95	450 200 190	ns
Low Level to High Impedance, $t_{PLZ}$			5 10 15	— — —	285 130 95	570 260 190	ns
	Input Rise or Fall Times, $t_r$ , $t_f$ Comparator Input, Term. 3		5 10 15	— — —	— — —	50 1 0.3	$\mu\text{s}$
		Signal Input, Term. 14	5 10 15	— — —	— — —	500 20 2.5	$\mu\text{s}$
Output Transition Times, $t_{THL}$ , $t_{TLH}$			5 10 15	— — —	100 50 40	200 100 80	ns

\* For sine wave, the frequency must be greater than 10 kHz for Phase Comparator II.

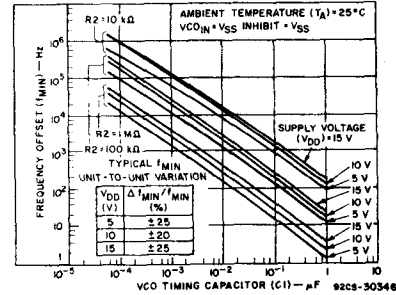

Fig. 6 — Typical frequency offset as a function of C1 and R2 for  $V_{DD} = 5\text{ V}$ ,  $10\text{ V}$ , and  $15\text{ V}$ .

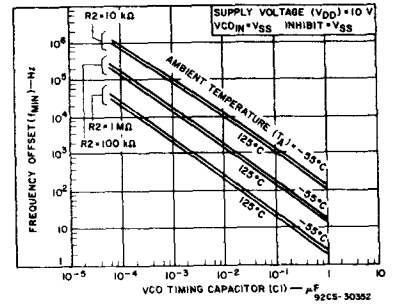

Fig. 7 — Frequency offset as a function of C1 and R2 for ambient temperatures of  $-55^\circ\text{C}$  to  $125^\circ\text{C}$ .

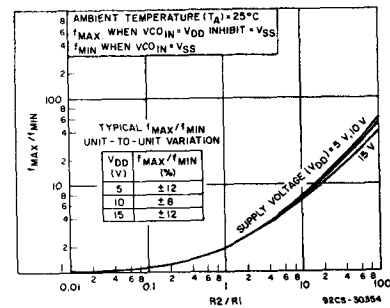

Fig. 8 — Typical  $f_{MAX}/f_{MIN}$  as a function of  $R2/R1$ .

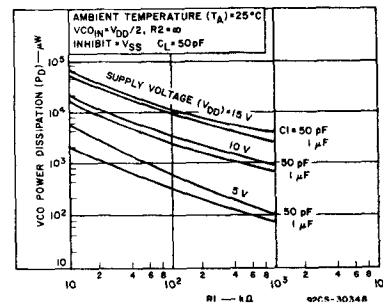

Fig. 9 — Typical VCO power dissipation at center frequency as a function of  $R1$ .

# CD4046B Types

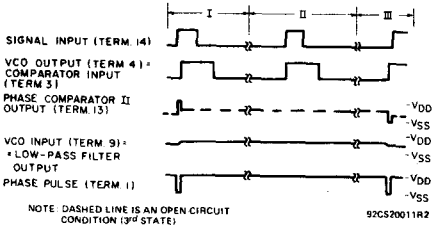

Fig. 10 - Typical waveforms for COS/MOS phase-locked loop employing phase comparator II in locked condition.

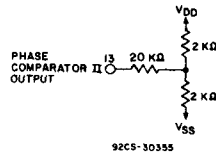

Fig. 11 - Phase comparator II output loading circuit.

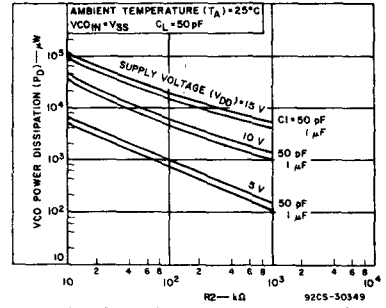

Fig. 12 - Typical VCO power dissipation at  $f_{MIN}$  as a function of  $R_2$ .

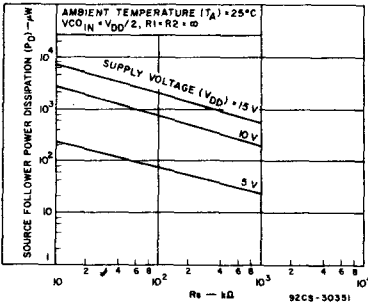

Fig. 13 - Typical source follower power dissipation as a function of  $R_s$ .

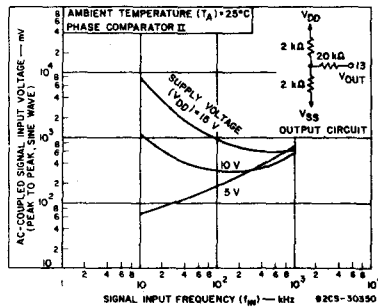

Fig. 14 - AC-coupled signal input voltage as a function of signal input frequency.

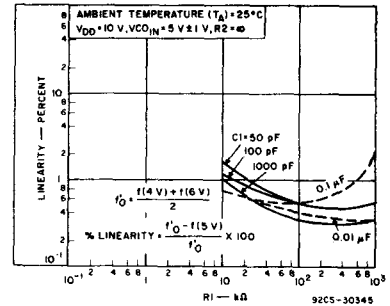

Fig. 15 - Typical VCO linearity as a function of  $R_1$  and  $C_1$  at  $V_{DD} = 10$  V.

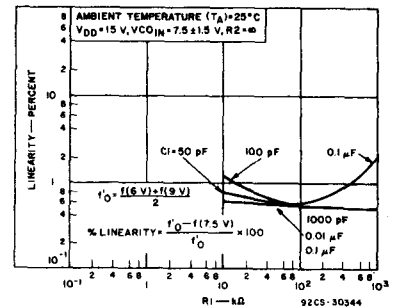
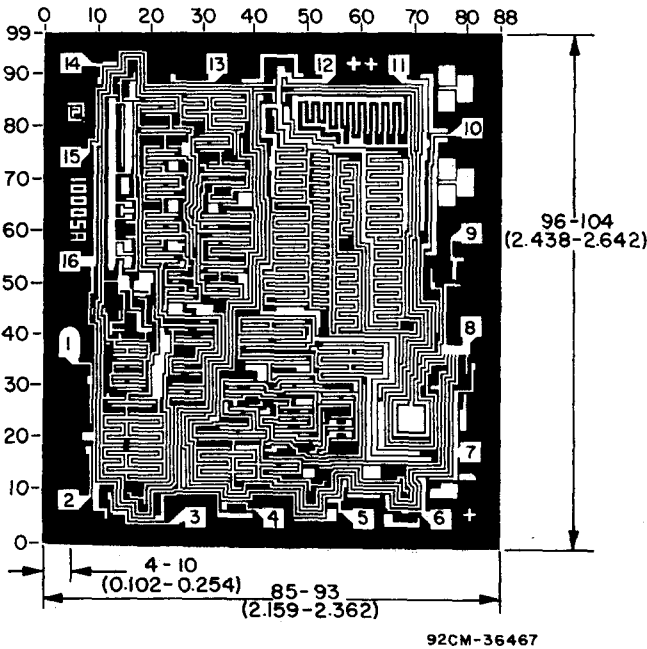

Fig. 16 - Typical VCO linearity as a function of  $R_1$  and  $C_1$  at  $V_{DD} = 15$  V.



92CM-36467

Dimensions and pad layout for CD4046BH.

Dimensions in parentheses are in millimeters and are derived from the basic inch dimensions as indicated. Grid graduations are in mils ( $10^{-3}$  inch).

The photographs and dimensions of each CMOS chip represent a chip when it is part of the wafer. When the wafer is separated into individual chips, the angle of cleavage may vary with respect to the chip face for different chips. The actual dimensions of the isolated chip, therefore, may differ slightly from the nominal dimensions shown. The user should consider a tolerance of  $\pm 3$  mils to  $\pm 16$  mils applicable to the nominal dimensions shown.

## CD4047B Types

# CMOS Low-Power Monostable/Astable Multivibrator

### High Voltage Types (20-Volt Rating)

The RCA-CD4047B consists of a gatable astable multivibrator with logic techniques incorporated to permit positive or negative edge-triggered monostable multivibrator action with retrigging and external counting options.

Inputs include + TRIGGER, -TRIGGER, ASTABLE, ASTABLE, RETRIGGER, and EXTERNAL RESET. Buffered outputs are Q, Q, and OSCILLATOR. In all modes of operation, and external capacitor must be connected between C-Timing and RC-Common terminals, and an external resistor must be connected between the R-Timing and RC-Common terminals.

Astable operation is enabled by a high level on the ASTABLE input or a low level on the ASTABLE input, or both. The period of the square wave at the Q and Q Outputs in this mode of operation is a function of the external components employed. "True" input pulses on the ASTABLE input or "Complement" pulses on the ASTABLE input allow the circuit to be used as a gatable multivibrator. The OSCILLATOR output period will be half of the Q terminal output in the astable mode. However, a 50% duty cycle is not guaranteed at this output.

The CD4047B triggers in the monostable mode when a positive-going edge occurs on the + TRIGGER-input while the -TRIGGER is held low. Input pulses may be of any duration relative to the output pulse.

If retrigger capability is desired, the RETRIGGER input is pulsed. The retriggerable mode of operation is limited to positive-going edge. The CD4047B will retrigger as long as the RETRIGGER-input is high, with or without transitions (See Fig. 34).

An external countdown option can be implemented by coupling "Q" to an external "N" counter and resetting the counter with the trigger pulse. The counter output pulse is fed back to the ASTABLE input and has a duration equal to N times the period of the multivibrator.

A high level on the EXTERNAL RESET input assures no output pulse during an "ON" power condition. This input can also be activated to terminate the output pulse at any time, for monostable operation, whenever V<sub>DD</sub> is applied, an internal power-on reset circuit will clock the Q output low within one output period (t<sub>M</sub>).

The CD4047B-Series types are supplied in 14-lead hermetic dual-in-line ceramic packages (D and F suffixes), 14-lead dual-in-line plastic packages (E suffix), 14-lead ceramic flat packages (K suffix), and in chip form (H suffix).

### Features:

- Low power consumption: special CMOS oscillator configuration
- Monostable (one-shot) or astable (free-running) operation
- True and complemented buffered outputs
- Only one external R and C required
- Buffered inputs
- 100% tested for quiescent current at 20 V
- Standardized, symmetrical output characteristics
- 5-V, 10-V, and 15-V parametric ratings
- Meets all requirements of JEDEC Tentative Standard No. 13B, "Standard Specifications for Description of 'B' Series CMOS Devices"

### Monostable Multivibrator Features:

- Positive- or negative-edge trigger
- Output pulse width independent of trigger pulse duration
- Retriggerable option for pulse width expansion
- Internal power-on reset circuit
- Long pulse widths possible using small RC components by means of external counter provision
- Fast recovery time essentially independent of pulse width
- Pulse-width accuracy maintained at duty cycles approaching 100%

### Astable Multivibrator Features:

- Free-running or gatable operating modes
- 50% duty cycle

- Oscillator output available
- Good astable frequency stability:  
Frequency deviation:  
= ±2% + 0.03%/°C @ 100 kHz  
= ±0.5% + 0.015%/°C @ 10 kHz  
(circuits "trimmed" to frequency V<sub>DD</sub> = 10 V ± 10%)

### Applications:

Digital equipment where low-power dissipation and/or high noise immunity are primary design requirements:

- Envelope detection
- Frequency multiplication
- Frequency division
- Frequency discriminators
- Timing circuits
- Time-delay applications

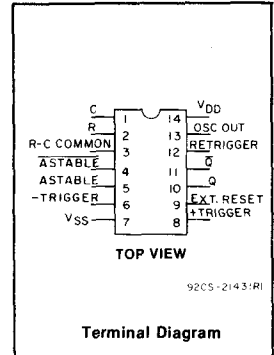

### RECOMMENDED OPERATING CONDITIONS

For maximum reliability, nominal operating conditions should be selected so that operation is always within the following ranges:

CHARACTERISTIC	LIMITS		UNITS
	MIN.	MAX.	
Supply-Voltage Range (For T <sub>A</sub> = Full Package-Temperature Range)	3	18	V
NOTE: IF AT 15 V OPERATION A 10 MΩ RESISTOR IS USED THE OPERATING TEMPERATURE SHOULD BE BETWEEN -25°C and 100°C			

### MAXIMUM RATINGS, Absolute-Maximum Values:

DC SUPPLY-VOLTAGE RANGE, (V <sub>DD</sub> ) (Voltages referenced to V <sub>SS</sub> Terminal)	-0.5 to +20 V
INPUT VOLTAGE RANGE, ALL INPUTS	-0.5 to V <sub>DD</sub> +0.5 V
DC INPUT CURRENT, ANY ONE INPUT	±10 mA
POWER DISSIPATION PER PACKAGE (P <sub>D</sub> ):	
For T <sub>A</sub> = -40 to +60°C (PACKAGE TYPE E)	500 mW
For T <sub>A</sub> = +60 to +85°C (PACKAGE TYPE E)	Derate Linearly at 12 mW/°C to 200 mW
For T <sub>A</sub> = -55 to +100°C (PACKAGE TYPES D, F, K)	500 mW
For T <sub>A</sub> = +100 to +125°C (PACKAGE TYPES D, F, K)	Derate Linearly at 12 mW/°C to 200 mW
DEVICE DISSIPATION PER OUTPUT TRANSISTOR:	
For T <sub>A</sub> = FULL PACKAGE-TEMPERATURE RANGE (All Package Types)	100 mW
OPERATING-TEMPERATURE RANGE (T <sub>A</sub> ):	
PACKAGE TYPES D, F, K, H	-55 to +125°C
PACKAGE TYPE E	-40 to +85°C
STORAGE TEMPERATURE RANGE (T <sub>stg</sub> )	
	-65 to +150°C
LEAD TEMPERATURE (DURING SOLDERING):	
At distance 1/16 ± 1/32 inch (1.59 ± 0.79 mm) from case for 10 s max.	+265°C



# CD4047B Types

**CD4047B FUNCTIONAL TERMINAL CONNECTIONS**  
**NOTE: IN ALL CASES EXTERNAL RESISTOR BETWEEN TERMINALS 2 AND 3A**  
**EXTERNAL CAPACITOR BETWEEN TERMINALS 1 AND 3A**

FUNCTION	TERMINAL CONNECTIONS			OUTPUT PULSE FROM	OUTPUT PERIOD OR PULSE WIDTH
	TO V <sub>DD</sub>	TO V <sub>SS</sub>	INPUT TO		
Astable Multivibrator:					
Free Running	4,5,6,14	7,8,9,12	—	10,11,13	$t_A(10,11) = 4.40 RC$
True Gating	4,6,14	7,8,9,12	5	10,11,13	$t_A(13) = 2.20 RC^{\#}$
Complement Gating	6,14	5,7,8,9,12	4	10,11,13	
Monostable Multivibrator:					
Positive-Edge Trigger	4,14	5,6,7,9,12	8	10,11	$t_M(10,11) = 2.48 RC$
Negative-Edge Trigger	4,8,14	5,7,9,12	6	10,11	
Retriggerable	4,14	5,6,7,9	8,12	10,11	
External Countdown*	14	5,6,7,8,9,12	—	10,11	

▲ See Text.

# First positive 1/2 cycle pulse-width = 2.48 RC, see Note on Page 10.

\* Input Pulse to Reset of External Counting Chip External Counting Chip Output To Terminal 4

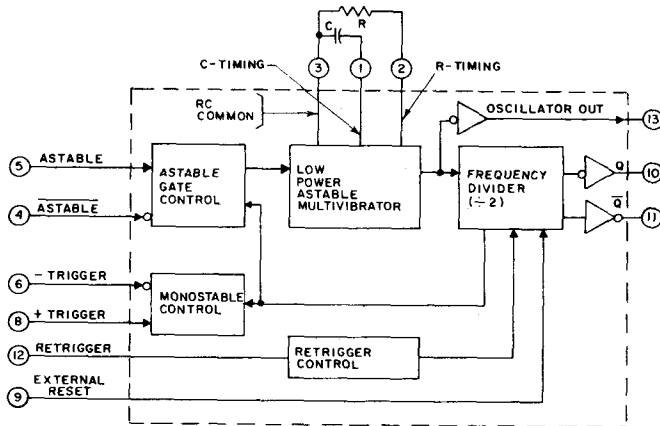

Fig. 1—CD4047B logic block diagram.

92CS-29071

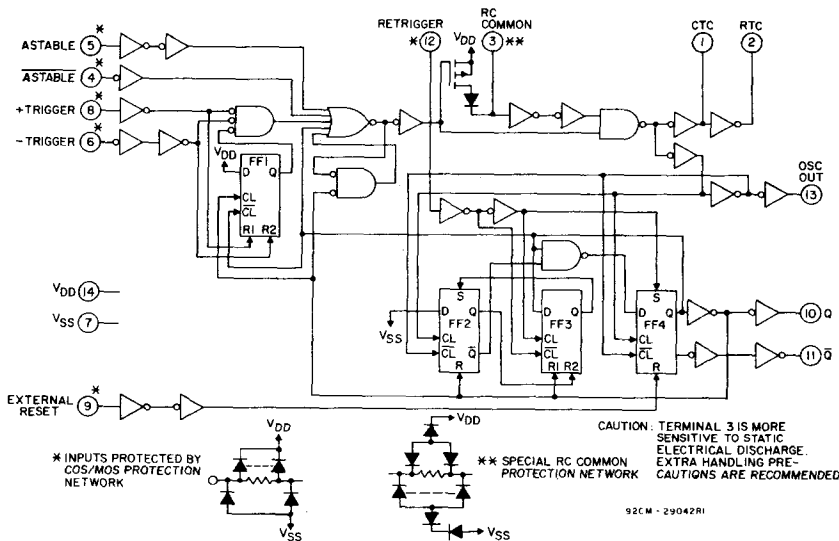

Fig. 2—CD4047B logic diagram.

92CM-29042R1

# CD4047B Types

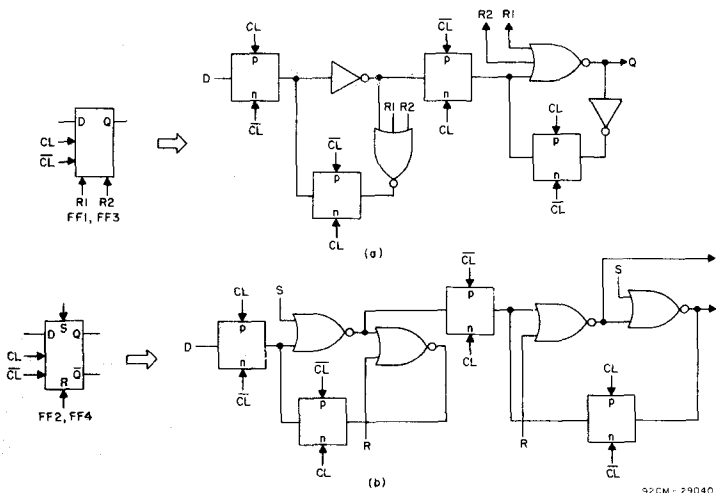

Fig. 3—Detail logic diagram for flip-flops FF1 and FF3 (a) and for flip-flops FF2 and FF4 (b).

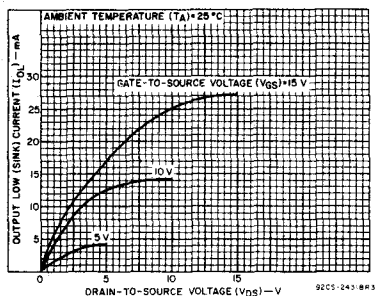

Fig. 4—Typical output low (sink) current characteristics.

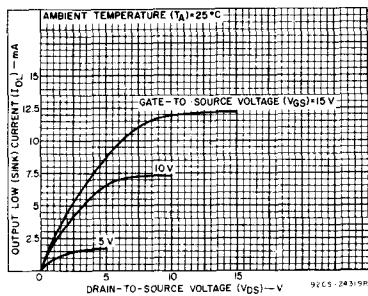

Fig. 5—Minimum output low (sink) current characteristics.

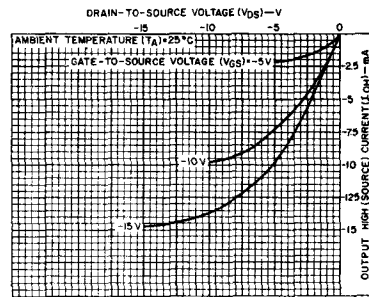

Fig. 6—Typical output high (source) current characteristics.

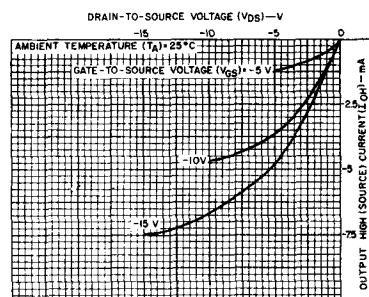

Fig. 7—Minimum output high (source) current characteristics.

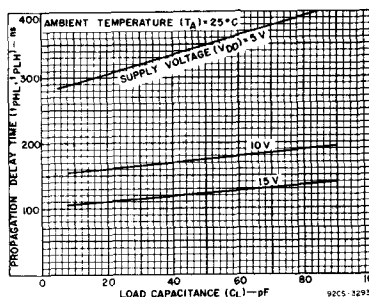

Fig. 8—Typical propagation delay time as a function of load capacitance (Astable, Astable to Q, Q-bar).

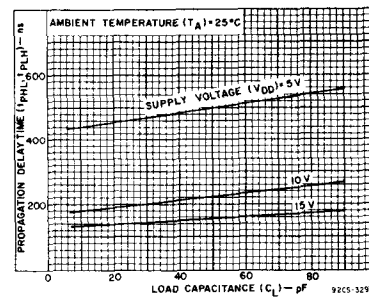

Fig. 9—Typical propagation delay time as a function of load capacitance (+ or - trigger to Q, Q-bar).

## STATIC ELECTRICAL CHARACTERISTICS

CHARACTERISTICS	CONDITIONS			LIMITS AT INDICATED TEMPERATURES (°C)							UNITS
	V <sub>O</sub> (V)	V <sub>IN</sub> (V)	V <sub>DD</sub> (V)	Values at -55, +25, +125 Apply to D, F, K, H Packages				Values at -40, +25, +85 Apply to E Package			
				-55	-40	+85	+125	+25			
								Min.	Typ.	Max.	
Quiescent Device Current, I <sub>DD</sub> Max.	—	0.5	5	1	1	30	30	—	0.02	1	μA
	—	0.10	10	2	2	60	60	—	0.02	2	
	—	0.15	15	4	4	120	120	—	0.02	4	
Output Low (Sink) Current I <sub>OL</sub> Min.	0.4	0.5	5	0.64	0.61	0.42	0.36	0.51	1	—	mA
	0.5	0.10	10	1.6	1.5	1.1	0.9	1.3	2.6	—	
	1.5	0.15	15	4.2	4	2.8	2.4	3.4	6.8	—	
Output High (Source) Current, I <sub>OH</sub> Min.	4.6	0.5	5	-0.64	-0.61	-0.42	-0.36	-0.51	-1	—	mA
	2.5	0.5	5	-2	-1.8	-1.3	-1.15	-1.6	-3.2	—	
	9.5	0.10	10	-1.6	-1.5	-1.1	-0.9	-1.3	-2.6	—	
Output Voltage: Low-Level V <sub>OL</sub> Max.	—	0.5	5	0.05			—	0	0.05	—	V
	—	0.10	10	0.05			—	0	0.05	—	
	—	0.15	15	0.05			—	0	0.05	—	

STATIC ELECTRICAL CHARACTERISTICS (CONTINUED)

CHARACTERISTICS	CONDITIONS			LIMITS AT INDICATED TEMPERATURES (°C)							UNITS	
	V <sub>O</sub> (V)	V <sub>IN</sub> (V)	V <sub>DD</sub> (V)	Values at -55, +25, +125 Apply to D, F, K, H Packages				Values at -40, +25, +85 Apply to E Package				
				-55	-40	+85	+125	+25				
				Min.	Typ.	Max.						
Output Voltage: High-Level, V <sub>OH</sub> Min.	—	0.5	5	4.95				4.95	5	—		V
	—	0,10	10	9.95				9.95	10	—		
	—	0,15	15	14.95				14.95	15	—		
Input Low Voltage, V <sub>IL</sub> Max.	0.5,4,5	—	5	1.5				—	—	1.5		V
	1.9	—	10	3				—	—	3		
	1.5,13,5	—	15	4				—	—	4		
Input High Voltage, V <sub>IH</sub> Min.	0.5,4,5	—	5	3.5				3.5	—	—		V
	1.9	—	10	7				7	—	—		
	1.5,13,5	—	15	11				11	—	—		
Input Current I <sub>IN</sub> Max.	—	0,18	18	±0.1	±0.1	±1	±1	—	±10 <sup>5</sup>	±0.1		μA

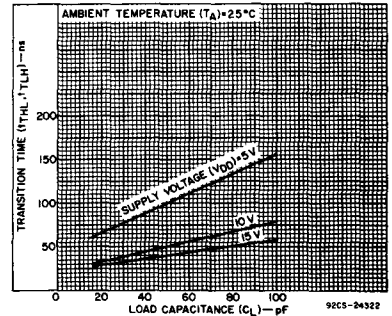

Fig. 10—Typical transition time as a function of load capacitance.

DYNAMIC ELECTRICAL CHARACTERISTICS at T<sub>A</sub> = 25°C, Input t<sub>r</sub>, t<sub>f</sub> = 20 ns, C<sub>L</sub> = 50 pF, R<sub>L</sub> = 200 kΩ

CHARACTERISTICS	V <sub>DD</sub> (V)	LIMITS			UNITS	
		Min.	Typ.	Max.		
Propagation Delay Time: Astable, Astable to Osc. Out	t <sub>PHL</sub> , t <sub>PLH</sub>	5	—	200	400	ns
	—	10	—	100	200	
	—	15	—	80	160	
Astable, Astable to Q, Q̄	—	5	—	350	700	
	—	10	—	175	350	
	—	15	—	125	250	
+ or - Trigger to Q, Q̄	—	5	—	500	1000	
	—	10	—	225	450	
	—	15	—	150	300	
Retrigger to Q, Q̄	—	5	—	300	600	
	—	10	—	150	300	
	—	15	—	100	200	
External Reset to Q, Q̄	—	5	—	250	500	
	—	10	—	100	200	
	—	15	—	70	140	
Transition Time: Osc. Out, Q, Q̄	t <sub>THL</sub> , t <sub>TLH</sub>	5	—	100	200	
	—	10	—	50	100	
	—	15	—	40	80	
Minimum Input Pulse Width: + Trigger, - Trigger	t <sub>W</sub>	5	—	200	400	
	—	10	—	80	160	
	—	15	—	50	100	
Reset	—	5	—	100	200	
	—	10	—	50	100	
	—	15	—	30	60	
Retrigger	—	5	—	300	600	
	—	10	—	115	230	
	—	15	—	75	150	
Input Rise and Fall Time: All Inputs	t <sub>r</sub> , t <sub>f</sub>	5	Unlimited			μs
	—	10	—			
	—	15	—			
Q or Q̄ Deviation from 50% Duty Factor	—	5	—	±0.5	±1	%
	—	10	—	±0.5	±1	
	—	15	—	±0.1	±0.5	
Input Capacitance,	C <sub>IN</sub>	Any Input	—	5	7.7	pF

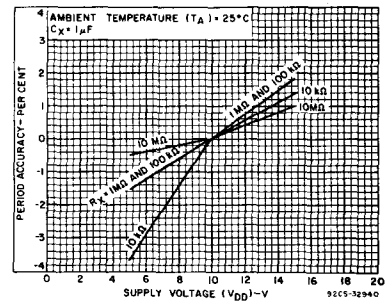

Fig. 11—Typical astable oscillator or Q, Q̄ period accuracy vs. supply voltage.

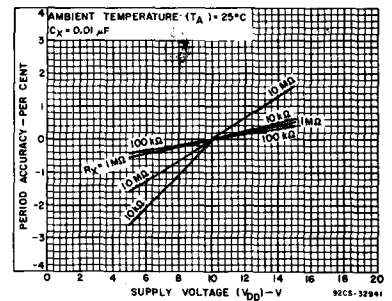

Fig. 12—Typical astable oscillator or Q, Q̄ period accuracy vs. supply voltage.

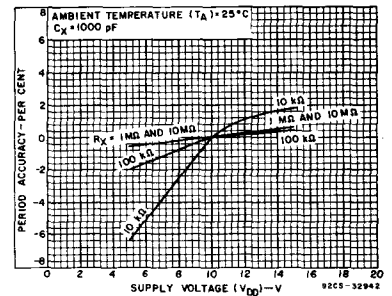

Fig. 13—Typical astable oscillator or Q, Q̄ period accuracy vs. supply voltage.



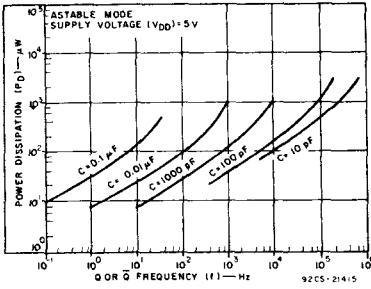

Fig. 26—Typical power dissipation vs. output frequency ( $V_{DD} = 5$  V).

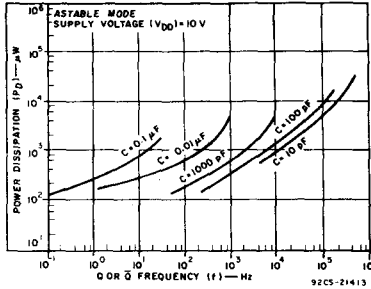

Fig. 27—Typical power dissipation vs. output frequency ( $V_{DD} = 10$  V).

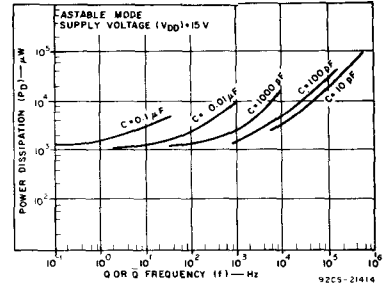

Fig. 28—Typical power dissipation vs. output frequency ( $V_{DD} = 15$  V).

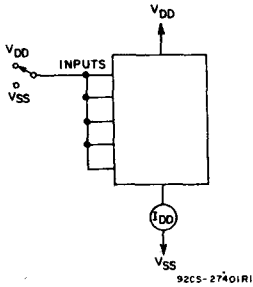

Fig. 29—Quiescent device current test circuit.

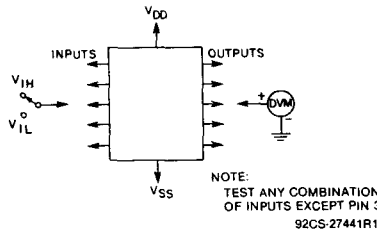

Fig. 30—Input-voltage test circuit.

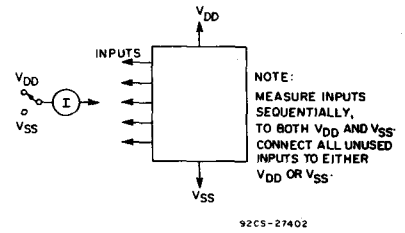

Fig. 31—Input-leakage-current test circuit.

1. Astable Mode Design Information

**A. Unit-to-Unit Transfer-Voltage Variations** — The following analysis presents variations from unit to unit as a function of transfer-voltage ( $V_{TR}$ ) shift (33%—67%  $V_{DD}$ ) for free-running (astable) operation.

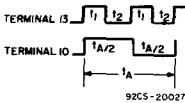

Fig. 32—Astable mode waveforms.

$$t_1 = -RC \ln \frac{V_{TR}}{V_{DD} + V_{TR}};$$

typically,  $t_1 = 1.1 RC$

$$t_2 = -RC \ln \frac{V_{DD} - V_{TR}}{2V_{DD} - V_{TR}};$$

typically,  $t_2 = 1.1 RC$

$$t_A = 2(t_1 + t_2)$$

$$= -2RC \ln \frac{(V_{TR}V_{DD} - V_{TR})}{(V_{DD} + V_{TR})(2V_{DD} - V_{TR})}$$

Typ:  $V_{TR} = 0.5 V_{DD}$        $t_A = 4.40 RC$   
 Min:  $V_{TR} = 0.33 V_{DD}$      $t_A = 4.62 RC$   
 Max:  $V_{TR} = 0.67 V_{DD}$      $t_A = 4.62 RC$

thus if  $t_A = 4.40 RC$  is used, the variation will be +5%, -0% due to variations in transfer voltage.

**B. Variations Due to  $V_{DD}$  and Temperature Changes** — In addition to variations from unit to unit, the astable period varies with  $V_{DD}$  and temperature. Typical variations are presented in graphical form in Figs. 11 to 18 with 10 V as reference for voltage variations curves and 25°C as reference for temperature variations curves.

II. Monostable Mode Design Information

The following analysis presents variations from unit to unit as a function of transfer-voltage ( $V_{TR}$ ) shift (33% — 67%  $V_{DD}$ ) for one-shot (monostable) operation.

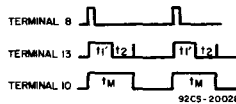

Fig. 33—Monostable waveforms.

$$t_1' = -RC \ln \frac{V_{TR}}{2V_{DD}};$$

typically,  $t_1' = 1.38 RC$

$$t_M = (t_1' + t_2)$$

$$t_M = -RC \ln \frac{(V_{TR})(V_{DD} - V_{TR})}{(2V_{DD} - V_{TR})(2V_{DD})}$$

where  $t_M$  = Monostable mode pulse width. Values for  $t_M$  are as follows:

Typ:  $V_{TR} = 0.5 V_{DD}$        $t_M = 2.48 RC$   
 Min:  $V_{TR} = 0.33 V_{DD}$      $t_M = 2.71 RC$   
 Max:  $V_{TR} = 0.67 V_{DD}$      $t_M = 2.48 RC$

thus if  $t_M = 2.48 RC$  is used, the variation will be +9.3%, -0% due to variations in transfer voltage.

**Note:**

In the astable mode, the first positive half cycle has a duration of  $t_M$ ; succeeding durations are  $t_A/2$ .

In addition to variations from unit to unit, the monostable pulse width varies with  $V_{DD}$  and temperature. These variations are presented in graphical form in Fig. 19 to 26 with 10 V as reference for voltage-variation curves and 25°C as reference for temperature-variation curves.

# CD4047B Types

## III. Retrigger Mode Operation

The CD4047B can be used in the retrigger mode to extend the output-pulse duration, or to compare the frequency of an input signal with that of the internal oscillator. In the retrigger mode the input pulse is applied to terminal 12, and the output is taken from terminal 10 or 11. As shown in Fig. 34 normal monostable action is obtained when one retrigger pulse is applied. Extended pulse duration is obtained when more than one pulse is applied.

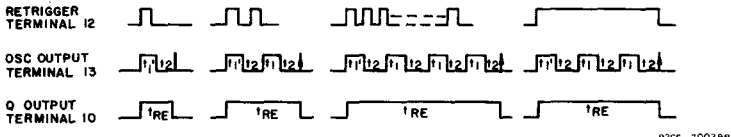

Fig. 34—Retrigger-mode waveforms.

For two input pulses,  $t_{RE} = t_1' + t_1 + 2t_2$ . For more than two pulses, the output pulse width is an integral number of time periods, with the first time period being  $t_1' + t_2$ , typically,  $2.48RC$ , and all subsequent time periods being  $t_1 + t_2$ , typically,  $2.2RC$ .

## IV. External Counter Option

Time  $t_M$  can be extended by any amount with the use of external counting circuitry.

Advantages include digitally controlled pulse duration, small timing capacitors for long time periods, and extremely fast recovery time. A typical implementation is shown in Fig. 35. The pulse duration at the output is

$$t_{ext} = (N - 1)(t_A) + (t_M + t_A/2)$$

where  $t_{ext}$  = pulse duration of the circuitry, and  $N$  is the number of counts used.

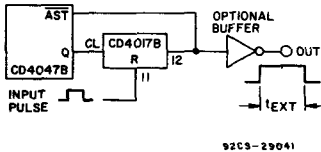

Fig. 35—Implementation of external counter option.

## V. Timing-Component Limitations

The capacitor used in the circuit should be non-polarized and have low leakage (i.e. the parallel resistance of the capacitor should be at least an order of magnitude greater than the external resistor used). There is no upper or lower limit for either  $R$  or  $C$  value to maintain oscillation.

However, in consideration of accuracy,  $C$  must be much larger than the inherent stray capacitance in the system (unless this capacitance can be measured and taken into account).  $R$  must be much

larger than the CMOS "ON" resistance in series with it, which typically is hundreds of ohms. In addition, with very large values of  $R$ , some short-term instability with respect to time may be noted.

The recommended values for these components to maintain agreement with

tion of leakage current in the circuit, as shown in the static electrical characteristics. For dynamic operation, the power needed to charge the external timing capacitor  $C$  is given by the following formulae:

Astable Mode:

$$P = 2CV^2f. \text{ (Output at terminal No. 13)}$$

$$P = 4CV^2f. \text{ (Output at terminal Nos. 10 and 11)}$$

Monostable Mode:

$$P = \frac{(2.9CV^2) \text{ (Duty Cycle)}}{T}$$

(Output at terminal Nos. 10 and 11)

The circuit is designed so that most of the total power is consumed in the external components. In practice, the lower the values of frequency and voltage used, the closer the actual power dissipation will be to the calculated value.

Because the power dissipation does not depend on  $R$ , a design for minimum power dissipation would be a small value of  $C$ . The value of  $R$  would depend on the desired period (within the limitations discussed above). See Figs. 27, 28, and 29 for typical power consumption in astable mode.

previously calculated formulas without trimming should be:

$C \geq 100 \text{ pF}$ , up to any practical value, for astable modes;

$C \geq 1000 \text{ pF}$ , up to any practical value for monostable modes.

$$10 \text{ k}\Omega \leq R \leq 1 \text{ M}\Omega$$

## VI. Power Consumption

In the standby mode (Monostable or Astable), power dissipation will be a func-

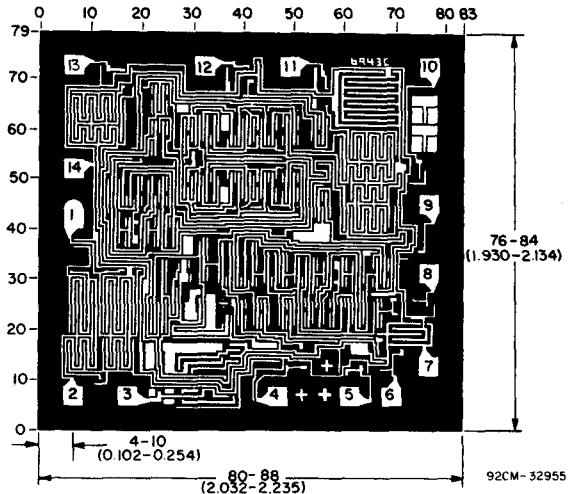

Dimensions in parentheses are in millimeters and are derived from the basic inch dimensions as indicated. Grid graduations are in mils ( $10^{-3}$  inch).

The photographs and dimensions of each CMOS chip represent a chip when it is part of the wafer. When the wafer is separated into individual chips, the angle of cleavage may vary with respect to the chip face for different chips. The actual dimensions of the isolated chip, therefore, may differ slightly from the nominal dimensions shown. The user should consider a tolerance of  $-3 \text{ mils to } +16 \text{ mils}$  applicable to the nominal dimensions shown.

Dimensions and pad layout for CD4047B.

## CMOS Multifunction Expandable 8-Input Gate

High-Voltage Types (20-Volt Rating)

The RCA-CD4048B is an 8-input gate having four control inputs. Three binary control inputs — Ka, Kb, and Kc — provide the implementation of eight different logic functions. These functions are OR, NOR, AND, NAND, OR/AND, OR/NAND, AND/OR and AND/NOR.

A fourth control input, Kd, provides the user with a 3-state output. When control input Kd is high, the output is either a logic 1 or a logic 0 depending on the inner states. When control input Kd is low, the output is an open circuit. This feature enables the user to connect this device to a common bus line.

In addition to the eight input lines, an EXPAND input is provided that permits the user to increase the number of inputs into a CD4048B (see Fig. 2). For example, two CD4048B's can be cascaded to provide a 16-input multifunction gate. When the EXPAND input is not used, it should be connected to VSS.

The CD4048B-series types are supplied in 16-lead hermetic dual-in-line ceramic packages (D and F suffixes), 16-lead dual-in-line plastic packages (E suffix), 16-lead ceramic flat packages (K suffix), and in chip form (H suffix).

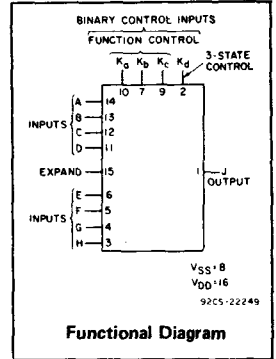

### MAXIMUM RATINGS, Absolute-Maximum Values:

DC SUPPLY-VOLTAGE RANGE, (V <sub>CC</sub> ) (Voltages referenced to V <sub>SS</sub> Terminal)	-0.5 to +20 V
INPUT VOLTAGE RANGE, ALL INPUTS	-0.5 to V <sub>DD</sub> +0.5 V
DC INPUT CURRENT, ANY ONE INPUT	±10 mA
POWER DISSIPATION PER PACKAGE (P <sub>D</sub> ):	
For T <sub>A</sub> = -40 to +60°C (PACKAGE TYPE E)	500 mW
For T <sub>A</sub> = +60 to +85°C (PACKAGE TYPE E)	Derate Linearly at 12 mW/°C to 200 mW
For T <sub>A</sub> = -55 to +100°C (PACKAGE TYPES D, F, K)	500 mW
For T <sub>A</sub> = +100 to +125°C (PACKAGE TYPES D, F, K)	Derate Linearly at 12 mW/°C to 200 mW
DEVICE DISSIPATION PER OUTPUT TRANSISTOR FOR T <sub>A</sub> = FULL PACKAGE-TEMPERATURE RANGE (All Package Types)	100 mW
OPERATING-TEMPERATURE RANGE (T <sub>A</sub> ):	
PACKAGE TYPES D, F, K, H	-55 to +125°C
PACKAGE TYPE E	-40 to +85°C
STORAGE TEMPERATURE RANGE (T <sub>stg</sub> )	-65 to +150°C
LEAD TEMPERATURE (DURING SOLDERING):	
At distance 1/16 ± 1/32 inch (1.59 ± 0.79 mm) from case for 10 s max.	+265°C

### Features:

- Three-state output
- Many logic functions available in one package
- Standardized, symmetrical output characteristics
- 100% tested for quiescent current at 20 V
- Maximum input current of 1 μA at 18 V (full package-temperature range), 100 nA at 18 V and 25°C
- Noise margin (full package-temperature range) = 1 V at V<sub>DD</sub>=5 V, 2 V at V<sub>DD</sub> = 10 V, 2.5 V at V<sub>DD</sub>=15 V
- 5-V, 10-V, and 15-V parametric ratings
- Meets all requirements of JEDEC Tentative Standard No. 13A, "Standard Specifications for Description of 'B' Series CMOS Devices"

### Applications:

- Selection of up to 8 logic functions
- Digital control of logic
- General-purpose gating logic
  - Decoding
  - Encoding

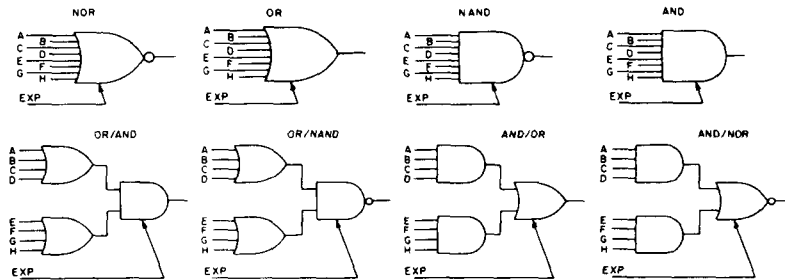
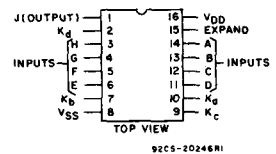

Fig. 1 - Basic logic configurations.

### RECOMMENDED OPERATING CONDITIONS

For maximum reliability, nominal operating conditions should be selected so that operation is always within the following ranges:

CHARACTERISTIC	LIMITS		UNITS
	MIN.	MAX.	
Supply-Voltage Range (For T <sub>A</sub> = Full Package Temperature Range)	3	18	V



### TERMINAL ASSIGNMENT

# CD4048B Types

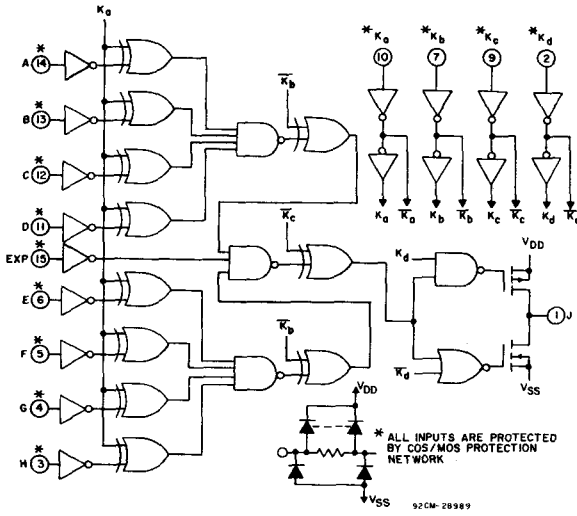

Fig. 2 - Logic diagram.

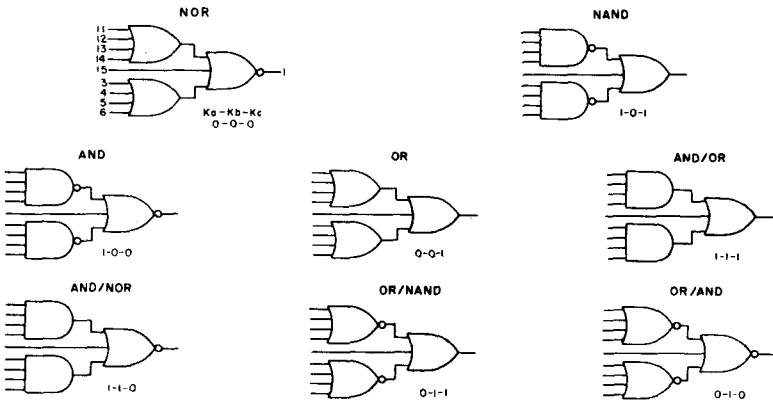

Fig. 3 - Actual-circuit logic configurations.

## APPLICATIONS OF EXPAND INPUT

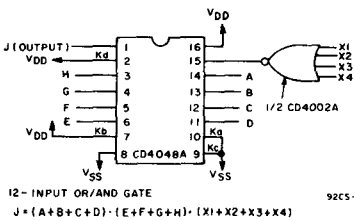

Fig. 4 - 12-input OR/AND gate.

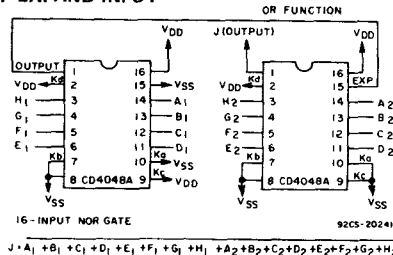

Fig. 5 - 16-input NOR gate.

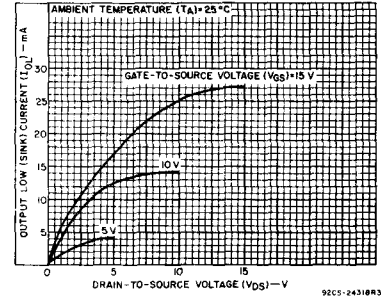

Fig. 6 - Typical output low (sink) current characteristics.

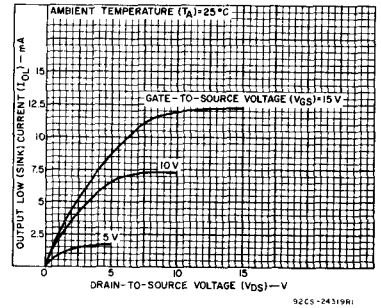

Fig. 7 - Minimum output low (sink) current characteristics.

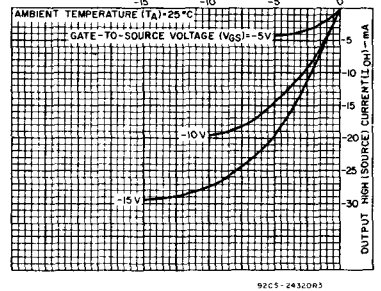

Fig. 8 - Typical output high (source) current characteristics.

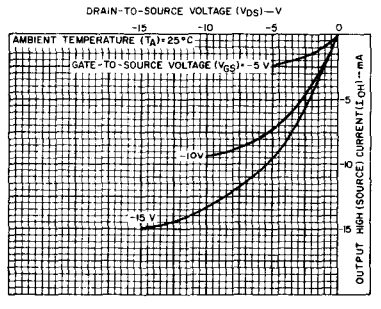

Fig. 9 - Minimum output high (source) current characteristics.



# CD4048B Types

## STATIC ELECTRICAL CHARACTERISTICS

CHARACTERISTIC	CONDITIONS			LIMITS AT INDICATED TEMPERATURES (°C)							UNITS
	V <sub>O</sub> (V)	V <sub>IN</sub> (V)	V <sub>DD</sub> (V)					+25			
				-55	-40	+85	+125	Min.	Typ.	Max.	
Quiescent Device Current, I <sub>DD</sub> Max.	-	0,5	5	0,25	0,25	7,5	7,5	-	0,01	0,25	μA
	-	0,10	10	0,5	0,5	15	15	-	0,01	0,5	
	-	0,15	15	1	1	30	30	-	0,01	1	
	-	0,20	20	5	5	150	150	-	0,02	5	
Output Low (Sink) Current I <sub>OL</sub> Min.	0,4	0,5	5	0,64	0,61	0,42	0,36	0,51	1	-	mA
	0,5	0,10	10	1,6	1,5	1,1	0,9	1,3	2,6	-	
	1,5	0,15	15	4,2	4	2,8	2,4	3,4	6,8	-	
Output High (Source) Current, I <sub>OH</sub> Min.	4,6	0,5	5	-0,64	-0,61	-0,42	-0,36	-0,51	-1	-	mA
	2,5	0,5	5	-2	-1,8	-1,3	-1,15	-1,6	-3,2	-	
	9,5	0,10	10	-1,6	-1,5	-1,1	-0,9	-1,3	-2,6	-	
	13,5	0,15	15	-4,2	-4	-2,8	-2,4	-3,4	-6,8	-	
Output Voltage: Low-Level, V <sub>OL</sub> Max.	-	0,5	5					0,05	0	0,05	V
	-	0,10	10					0,05	0	0,05	
	-	0,15	15					0,05	0	0,05	
Output Voltage: High-Level, V <sub>OH</sub> Min.	-	0,5	5					4,95	5	-	V
	-	0,10	10					9,95	10	-	
	-	0,15	15					14,95	15	-	
Input Low Voltage, V <sub>IL</sub> Max.	0,5, 4,5	-	5					1,5	-	1,5	V
	1,9	-	10					3	-	3	
	1,5, 13,5	-	15					4	-	4	
Input High Voltage, V <sub>IH</sub> Min.	0,5, 4,5	-	5					3,5	3,5	-	V
	1,9	-	10					7	7	-	
	1,5, 13,5	-	15					11	11	-	
Input Current I <sub>IN</sub> Max.		0,18	18	±0,1	±0,1	±1	±1	-	±10 <sup>-5</sup>	±0,1	μA
3-State Output Current, I <sub>OUT</sub>	0,18	0,18	18	±0,4	±0,4	±12	±12	-	±10 <sup>-4</sup>	±0,4	μA

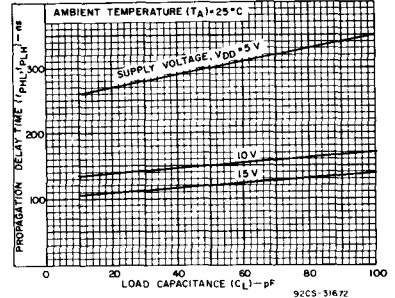

Fig. 10 - Typical propagation delay time (logic inputs to output) as a function of load capacitance.

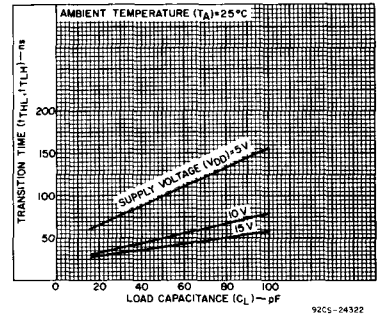

Fig. 11 - Typical transition time vs. load capacitance.

## IMPLEMENTATION OF EXPAND INPUT FOR 9 OR MORE INPUTS

OUTPUT FUNCTION	FUNCTION NEEDED AT EXPAND INPUT	OUTPUT BOOLEAN EXPRESSION
NOR	OR	$J = (A+B+C+D+E+F+G+H) + (EXP)$
OR	OR	$J = (A+B+C+D+E+F+G+H) + (EXP)$
AND	NAND	$J = (ABCDEFH) \cdot (\overline{EXP})$
NAND	NAND	$J = (ABCDEFH) \cdot (\overline{EXP})$
OR/AND	NOR	$J = (A+B+C+D) \cdot (E+F+G+H) \cdot (\overline{EXP})$
OR/NAND	NOR	$J = (A+B+C+D) \cdot (E+F+G+H) \cdot (\overline{EXP})$
AND/NOR	AND	$J = (ABCD) + (EFGH) + (EXP)$
AND/OR	AND	$J = (ABCD) + (EFGH) + (EXP)$

Note: (EXP) designates the EXPAND function (i.e.,  $X_1 + X_2 + \dots + X_N$ ).

**NOTE:**  
Refer to FUNCTION TRUTH TABLE for connection of unused inputs.

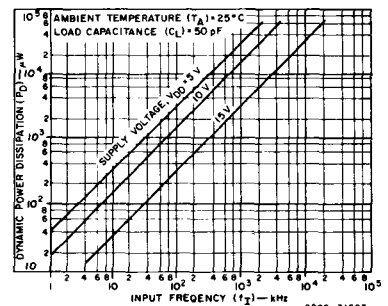

Fig. 12 - Typical power dissipation as a function of input frequency.

# CD4048B Types

DYNAMIC CHARACTERISTICS at  $T_A=25^\circ\text{C}$ ,  $C_L=50\text{ pF}$ , Input  $t_r, t_f=20\text{ ns}$ ,  $R_L=200\text{ k}\Omega$  unless otherwise specified

CHARACTERISTIC	TEST CONDITIONS	LIMITS		UNITS	
		$V_{DD}$ V	All Package Types		
			Typ.		Max.
Propagation Delay: $t_{PHL}, t_{PLH}$ Inputs to Output and Ka to Output Kb to Output		5	300	600	ns
		10	150	300	
		15	120	240	
Kc to Output		5	225	450	
		10	85	170	
		15	55	110	
Expand Input to Output		5	190	380	
		10	90	180	
		15	65	130	
3-State Propagation Delay: Kd to Output $t_{PHZ}, t_{PLZ}$ $t_{PZH}, t_{PZL}$	$R_L=1\text{ k}\Omega$ See Fig.21	5	80	160	
		10	35	70	
		15	25	50	
Transition Time: $t_{THL}, t_{TLH}$		5	100	200	
		10	50	100	
		15	40	80	
Input Capacitance: $C_i$	Any Input		5	7	pF
3-State Output Capacitance			5	10	

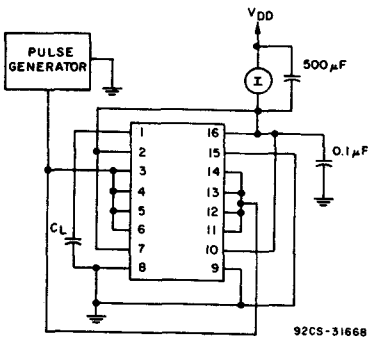

Fig. 13 - Dynamic power dissipation test circuit.

## FUNCTION TRUTH TABLE

OUTPUT FUNCTION	BOOLEAN EXPRESSION	$K_a$	$K_b$	$K_c$	UNUSED INPUT*
NOR	$J=A+B+C+D+E+F+G+H$	0	0	0	$V_{SS}$
OR	$J=A+B+C+D+E+F+G+H$	0	0	1	$V_{SS}$
OR/AND	$J=(A+B+C+D)-(E+F+G+H)$	0	1	0	$V_{SS}$
OR/NAND	$J=(A+B+C+D)-(E+F+G+H)$	0	1	1	$V_{SS}$
AND	$J=ABCDEFGH$	1	0	0	$V_{DD}$
NAND	$J=ABCDEFGH$	1	0	1	$V_{DD}$
AND/NOR	$J=ABCD+EFGH$	1	1	0	$V_{DD}$
AND/OR	$J=ABCD+EFGH$	1	1	1	$V_{DD}$

$K_d=1$  Normal Inverter Action  
 $K_d=0$  High Impedance Output

EXPAND Input=0

\* See Figs. 1,2,3,4, and 5.

## TEST CIRCUITS - STATIC MEASUREMENTS

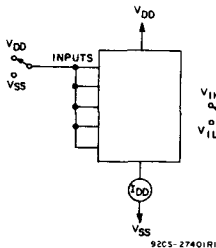

Fig. 14 - Quiescent device current test circuit.

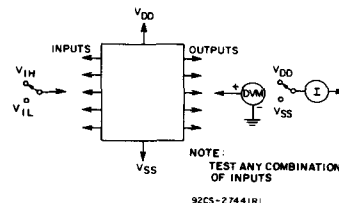

Fig. 15 - Input voltage test circuit.

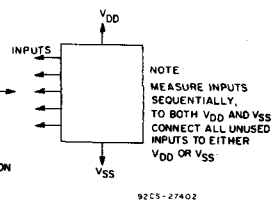

Fig. 16 - Input current test circuit.

## TEST CIRCUITS - DYNAMIC MEASUREMENTS

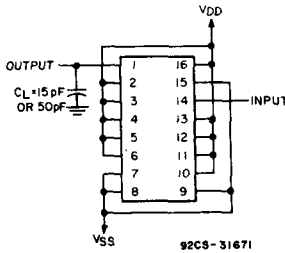

Fig. 17 - Test circuit for  $t_{PHL}$ ,  $t_{THL}$ , and  $t_{TLH}$  (AND) measurements.

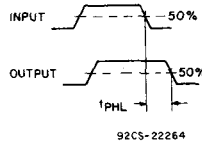

Fig. 18 - Waveforms for  $t_{PHL}$  and  $t_{PHL}$  (AND).

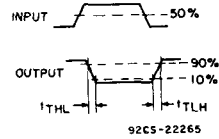

Fig. 19 - Waveforms for  $t_{THL}$  and  $t_{TLH}$  (AND).

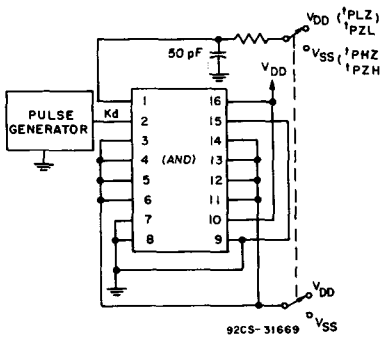

Fig. 20 - Test circuit for  $t_{PZL}$ ,  $t_{PZH}$ ,  $t_{PLZ}$ , and  $t_{PHZ}$  (AND).

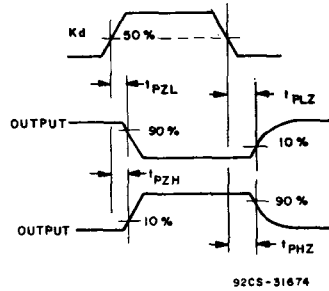
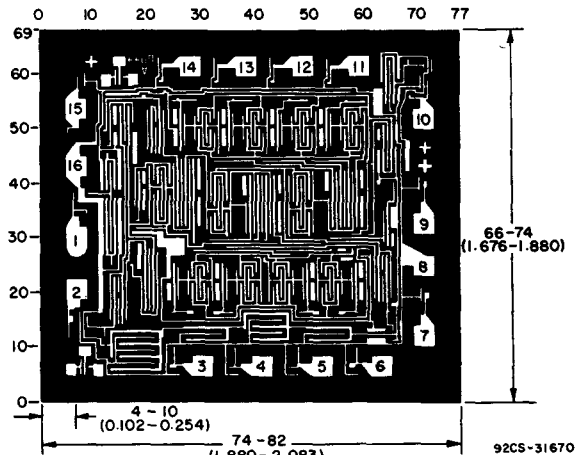

Fig. 21 - Waveforms for  $t_{PZL}$ ,  $t_{PZH}$ ,  $t_{PLZ}$ , and  $t_{PHZ}$  (AND).



Dimensions and pad layout for CD4048BH.

Dimensions in parentheses are in millimeters and are derived from the basic inch dimensions as indicated. Grid graduations are in mils ( $10^{-3}$  inch).

The photographs and dimensions of each CMOS chip represent a chip when it is part of the wafer. When the wafer is separated into individual chips, the angle of cleavage may vary with respect to the chip face for different chips. The actual dimensions of the isolated chip, therefore, may differ slightly from the nominal dimensions shown. The user should consider a tolerance of  $-3$  mils to  $+16$  mils applicable to the nominal dimensions shown.

# CD4049UB, CD4050B Types

## CMOS Hex Buffer/Converters

Features:

- High sink current for driving 2 TTL loads
- High-to-low level logic conversion
- 100% tested for quiescent current at 20 V
- Maximum input current of 1  $\mu$ A at 18 V over full package-temperature range; 100 nA at 18 V and 25°C
- 5-, 10-, and 15-volt parametric ratings

Applications:

- CMOS to DTL/TTL hex converter
- CMOS current "sink" or "source" driver
- CMOS high-to-low logic-level converter

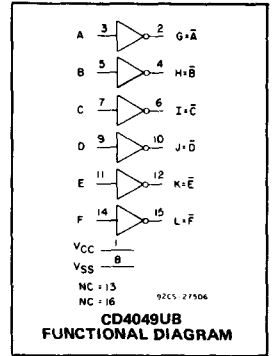

High-Voltage Types (20-Volt Rating)

CD4049UB—Inverting Type

CD4050B—Non-Inverting Type

The RCA-CD4049UB and CD4050B are inverting and non-inverting hex buffers, respectively, and feature logic-level conversion using only one supply (voltage  $V_{CC}$ ). The input-signal high level ( $V_{IH}$ ) can exceed the  $V_{CC}$  supply voltage when these devices are used for logic-level conversions. These devices are intended for use as CMOS to DTL/TTL converters and can drive directly two DTL/TTL loads. ( $V_{CC}=5$  V,  $V_{OL} \leq 0.4$  V, and  $I_{OL} \geq 3.3$  mA.)

The CD4049UB and CD4050B are designated as replacements for CD4009UB and CD4010B, respectively. Because the CD4049UB and CD4050B require only one power supply, they are preferred over the CD4009UB and CD4010B and should be used in place of the CD4009UB and CD4010B in all inverter, current driver, or logic-level conversion applications. In these applications the CD4049UB and CD4050B are pin compatible with the CD4009UB and CD4010B respectively, and can be substituted for these devices in existing as well as in new designs. Terminal No. 16 is not connected internally on the CD4049UB or CD4050B, therefore, connection to this terminal is of no consequence to circuit operation. For applications not requiring high sink-current or voltage conversion, the CD4069UB Hex Inverter is recommended.

The CD4049UB and CD4050B types are supplied in 16-lead hermetic dual-in-line ceramic packages (D and F suffixes), 16-lead dual-in-line plastic packages (E suffix), 16-lead ceramic flat packages (K suffix), and in chip form (H suffix).

### MAXIMUM RATINGS, Absolute-Maximum Values:

DC SUPPLY-VOLTAGE RANGE, ( $V_{CC}$ ) (Voltages referenced to $V_{SS}$ Terminal)	-0.5 to +20 V
INPUT VOLTAGE RANGE, ALL INPUTS	-0.5 to +20.5 V
DC INPUT CURRENT, ANY ONE INPUT	$\pm 10$ mA
POWER DISSIPATION PER PACKAGE ( $P_D$ ):	
For $T_A = -40$ to $+60^\circ\text{C}$ (PACKAGE TYPE E)	500 mW
For $T_A = +60$ to $+85^\circ\text{C}$ (PACKAGE TYPE E)	Derate Linearly at 12 mW/ $^\circ\text{C}$ to 200 mW
For $T_A = -55$ to $+100^\circ\text{C}$ (PACKAGE TYPES D, F, K)	500 mW
For $T_A = +100$ to $+125^\circ\text{C}$ (PACKAGE TYPES D, F, K)	Derate Linearly at 12 mW/ $^\circ\text{C}$ to 200 mW
DEVICE DISSIPATION PER OUTPUT TRANSISTOR FOR $T_A =$ FULL PACKAGE-TEMPERATURE RANGE (All Package Types)	100 mW
OPERATING-TEMPERATURE RANGE ( $T_A$ ):	
PACKAGE TYPES D, F, K, H	-55 to $+125^\circ\text{C}$
PACKAGE TYPE E	-40 to $+85^\circ\text{C}$
STORAGE TEMPERATURE RANGE ( $T_{stg}$ )	-65 to $+150^\circ\text{C}$
LEAD TEMPERATURE (DURING SOLDERING):	
At distance 1/16 $\pm$ 1/32 inch (1.59 $\pm$ 0.79 mm) from case for 10 s max.	$+265^\circ\text{C}$

RECOMMENDED OPERATING CONDITIONS at  $T_A=25^\circ\text{C}$ , Except as Noted.

For maximum reliability, nominal operating conditions should be selected so that operation is always within the following ranges:

CHARACTERISTIC	LIMITS		UNITS
	Min.	Max.	
Supply-Voltage Range ( $V_{CC}$ ) (For $T_A$ =Full Package-Temperature Range)	3	18	V
Input Voltage Range ( $V_{IN}$ )	$V_{CC}$	18	V

\*The CD4049 and CD4050 have high-to-low-level voltage conversion capability but not low-to-high-level; therefore it is recommended that  $V_{IN} \geq V_{CC}$ .

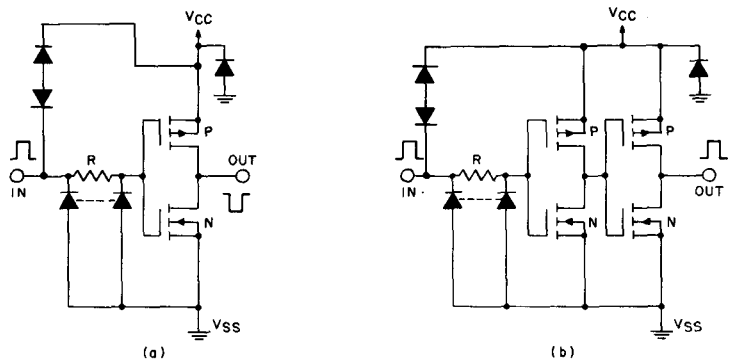
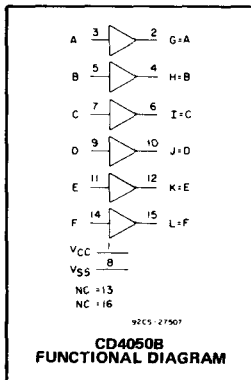

Fig. 1—a) Schematic diagram of CD4049UB, 1 of 6 identical units; b) Schematic diagram of CD4050B, 1 of 6 identical units.

# CD4049UB, CD4050B Types

## STATIC ELECTRICAL CHARACTERISTICS

CHARACTERISTIC	CONDITIONS		Limits At Indicated Temperatures (°C)									UNITS	
	V <sub>O</sub> (V)	V <sub>IN</sub> (V)	V <sub>CC</sub> (V)	Values at -55, +25, +125 Apply to D, F, K, H Pkgs.						Values at -40, +25, +85 Apply to E Package			
				-55	-40	+85	+125	+25					
								Min.	Typ.	Max.			
Quiescent Device Current, I <sub>DD</sub> Max.	-	0.5	5	1	1	30	30	-	0.02	1	μA		
	-	0.10	10	2	2	60	60	-	0.02	2			
	-	0.15	15	4	4	120	120	-	0.02	4			
Output Low (Sink) Current I <sub>OL</sub> Min.	0.4	0.5	4.5	3.3	3.1	2.1	1.8	2.6	5.2	-	mA		
	0.4	0.5	5	4	3.8	2.9	2.4	3.2	6.4	-			
	0.5	0.10	10	10	9.6	6.6	5.6	8	16	-			
Output High (Source) Current I <sub>OH</sub> Min.	1.5	0.15	15	26	25	20	18	24	48	-	mA		
	4.6	0.5	5	-0.81	-0.73	-0.58	-0.48	-0.65	-1.2	-			
	2.5	0.5	5	-2.6	-2.4	-1.9	-1.55	-2.1	-3.9	-			
Output Voltage: Low-Level, V <sub>OL</sub> Max.	9.5	0.10	10	-2.0	-1.8	-1.35	-1.18	-1.65	-3.0	-	V		
	13.5	0.15	15	-5.2	-4.8	-3.5	-3.1	-4.3	-8.0	-			
	-	0.5	5			0.05			0	0.05			
Output Voltage: High-Level, V <sub>OH</sub> Min.	-	0.10	10			0.05			0	0.05	V		
	-	0.15	15			0.05			0	0.05			
	-	0.5	5			4.95			4.95	5			
Input Low Voltage: V <sub>IL</sub> Max. CD4049UB	-	0.10	10			9.95			9.95	10	V		
	-	0.15	15			14.95			14.95	15			
	4.5	-	5			1			-	1			
Input Low Voltage: V <sub>IL</sub> Max. CD4050B	9	-	10			2			-	2	V		
	13.5	-	15			2.5			-	2.5			
	0.5	-	5			1.5			-	1.5			
Input High Voltage: V <sub>IH</sub> Min. CD4049UB	1	-	10			3			-	3	V		
	1.5	-	15			4			-	4			
	0.5	-	5			4			4	-			
Input High Voltage: V <sub>IH</sub> Min. CD4050B	1	-	10			8			8	-	V		
	1.5	-	15			12.5			12.5	-			
	4.5	-	5			3.5			3.5	-			
Input Current, I <sub>IN</sub> Max.	9	-	10			7			7	-	μA		
	13.5	-	15			11			11	-			
	-	0.18	18	±0.1	±0.1	±1	±1	-	±10 <sup>-5</sup>	±0.1			

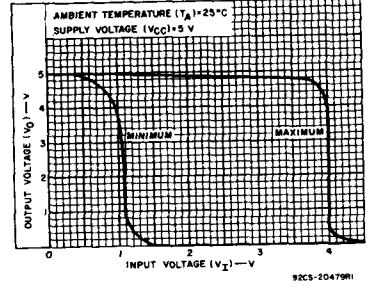

Fig. 2—Minimum and maximum voltage transfer characteristics for CD4049UB.

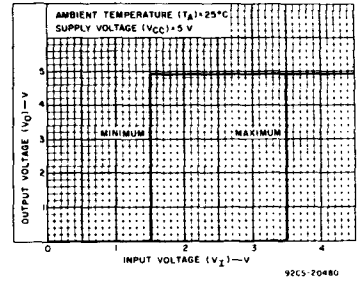

Fig. 3—Minimum and maximum voltage transfer characteristics for CD4050B.

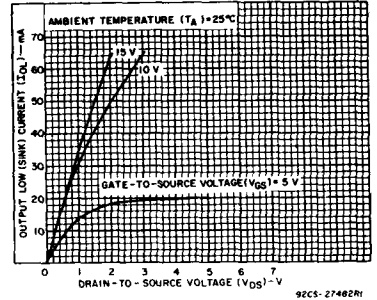

Fig. 4—Typical output low (sink) current characteristics.

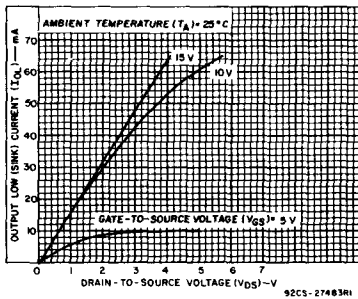

Fig. 5—Minimum output low (sink) current drain characteristics.

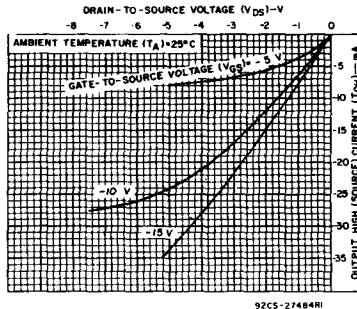

Fig. 6—Typical output high (source) current characteristics.

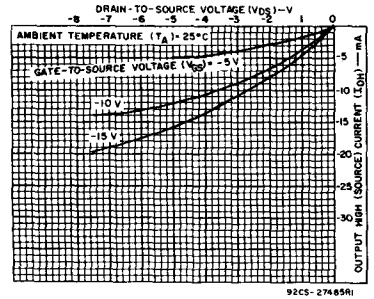

Fig. 7—Minimum output high (source) current characteristics.

# CD4049UB, CD4050B Types

DYNAMIC ELECTRICAL CHARACTERISTICS at  $T_A = 25^\circ\text{C}$ ; Input  $t_r, t_f = 20\text{ ns}$ ,  $C_L = 50\text{ pF}$ ,  $R_L = 200\text{ k}\Omega$

CHARACTERISTIC	CONDITIONS		LIMITS ALL PKGS.		UNITS	
	$V_{IN}$	$V_{CC}$	Typ.	Max.		
Propagation Delay Time: Low-to-High, $t_{PLH}$	CD4049UB	5	5	60	120	$\mu\text{s}$
		10	10	32	65	
		10	5	45	90	
		15	15	25	50	
		15	5	45	90	
	CD4050B	5	5	70	140	
		10	10	40	80	
		10	5	45	90	
		15	15	30	60	
		15	5	40	80	
High-to-Low, $t_{PHL}$	CD4049UB	5	5	32	65	$\mu\text{s}$
		10	10	20	40	
		10	5	15	30	
		15	15	15	30	
		15	5	10	20	
	CD4050B	5	5	55	110	
		10	10	22	55	
		10	5	50	100	
		15	15	15	30	
		15	5	50	100	
Transition Time: Low-to-High, $t_{TLH}$	CD4049UB	5	5	80	160	$\mu\text{s}$
		10	10	40	80	
		15	15	30	60	
	CD4050B	5	5	30	60	
		10	10	20	40	
		15	15	15	30	
Input Capacitance, $C_{IN}$	CD4049UB	—	—	15	22.5	$\mu\text{F}$
	CD4050B	—	—	5	7.5	

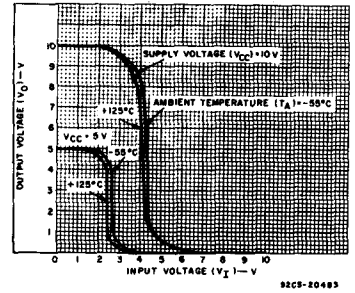

Fig. 8 — Typical voltage transfer characteristics as a function of temperature for CD4049UB.

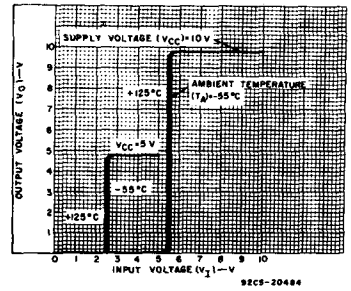

Fig. 9 — Typical voltage transfer characteristics as a function of temperature for CD4050B.

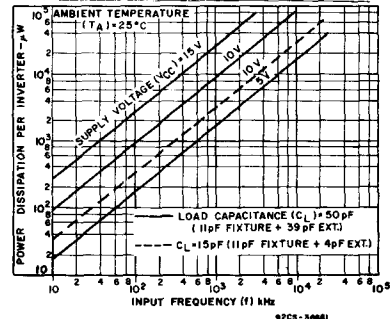

Fig. 10 — Typical power dissipation vs. frequency characteristics.

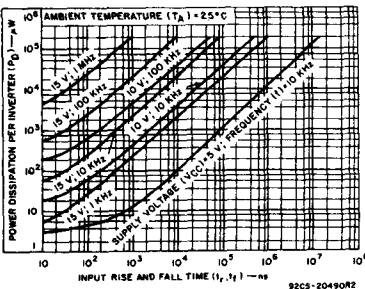

Fig. 11 — Typical power dissipation vs. input rise and fall times per inverter for CD4049UB.

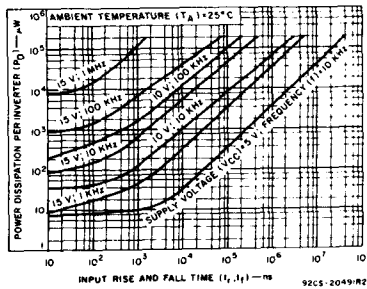

Fig. 12 — Typical power dissipation vs. input rise and fall times per inverter for CD4050B.

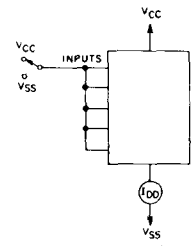

Fig. 13 — Quiescent device current test circuit.

# CD4049UB, CD4050B Types

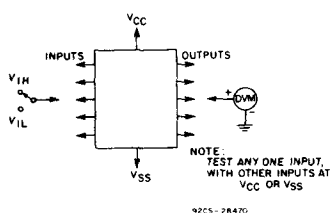

Fig. 14 - Input voltage test circuit.

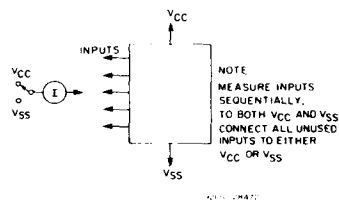

Fig. 15 - Input current test circuit.

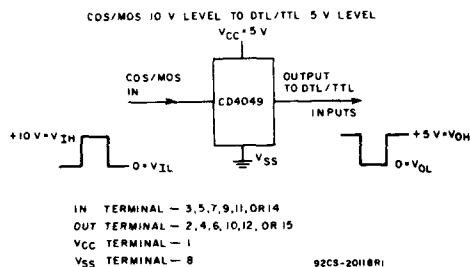
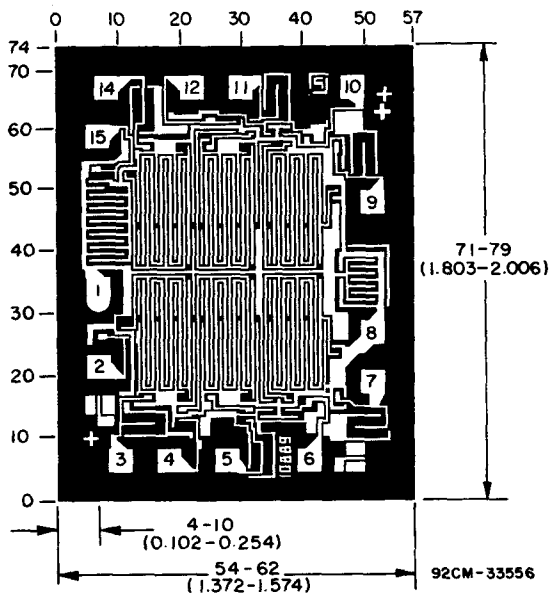

Fig. 16 - Logic-level conversion application.

## CHIP PHOTOGRAPHS DIMENSIONS AND PAD LAYOUTS



CD4049UBH

Dimensions in parentheses are in millimeters and are derived from the basic inch dimensions as indicated. Grid graduations are in mils ( $10^{-3}$  inch).

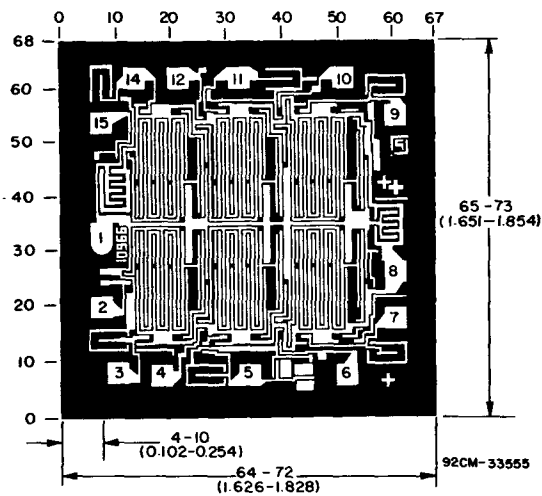

CD4050BH

The photographs and dimensions of each CMOS chip represent a chip when it is part of the wafer. When the wafer is separated into individual chips, the angle of cleavage may vary with respect to the chip face for different chips. The actual dimensions of the isolated chip, therefore, may differ slightly from the nominal dimensions shown. The user should consider a tolerance of  $-3$  mils to  $+16$  mils applicable to the nominal dimensions shown.

## TERMINAL ASSIGNMENTS

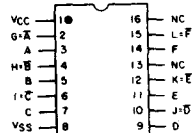

NC = NO CONNECTION 92CS-244BOR1

CD4049UB

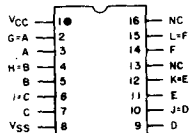

NC = NO CONNECTION 92CS-244BOR1

CD4050B

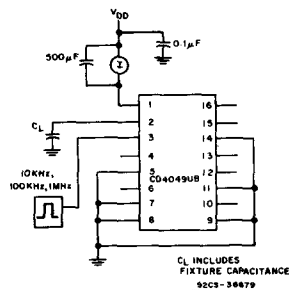

Fig. 17 - Dynamic power dissipation test circuit.

# CD4051B, CD4052B, CD4053B Types

## CMOS Analog Multiplexers/Demultiplexers\*

### With Logic-Level Conversion

### High-Voltages Types (20-Volt Rating)

- CD4051B – Single 8-Channel
- CD4052B – Differential 4-Channel
- CD4053B – Triple 2-Channel

RCA-CD4051B, CD4052B, and CD4053B analog multiplexers/demultiplexers are digitally controlled analog switches having low ON impedance and very low OFF leakage current. Control of analog signals up to 20 V peak-to-peak can be achieved by digital signal amplitudes of 4.5 to 20 V (if  $V_{DD}-V_{SS} = 3\text{ V}$ , a  $V_{DD}-V_{EE}$  of up to 13 V can be controlled; for  $V_{DD}-V_{EE}$  level differences above 13 V, a  $V_{DD}-V_{SS}$  of at least 4.5 V is required). For example, if  $V_{DD} = +4.5\text{ V}$ ,  $V_{SS} = 0$ , and  $V_{EE} = -13.5\text{ V}$ , analog signals from  $-13.5\text{ V}$  to  $+4.5\text{ V}$  can be controlled by digital inputs of 0 to 5 V. These multiplexer circuits dissipate extremely low quiescent power over the full  $V_{DD}-V_{SS}$  and  $V_{DD}-V_{EE}$  supply-voltage ranges, independent of the logic state of the control signals. When a logic "1" is present at the inhibit input terminal all channels are off.

The CD4051B is a single 8-channel multiplexer having three binary control inputs, A, B, and C, and an inhibit input. The three binary signals select 1 of 8 channels to be turned on, and connect one of the 8 inputs to the output.

The CD4052B is a differential 4-channel multiplexer having two binary control inputs, A and B, and an inhibit input. The two binary input signals select 1 of 4 pairs of channels to be turned on and connect the analog inputs to the outputs.

The CD4053B is a triple 2-channel multiplexer having three separate digital control inputs, A, B, and C, and an inhibit input. Each control input selects one of a pair of channels which are connected in a single-pole double-throw configuration.

The CD4051B, CD4052B, and CD4053B are supplied in 16-lead ceramic dual-in-line packages (D and F suffixes), 16-lead plastic dual-in-line packages (E suffix), 16-lead ceramic flat packages (K suffix), and in chip form (H suffix).

### Applications:

- Analog and digital multiplexing and demultiplexing
- A/D and D/A conversion
- Signal gating

### Features:

- Wide range of digital and analog signal levels: digital 3 to 20 V, analog to 20 V p-p
- Low ON resistance: 125  $\Omega$  (typ.) over 15 V p-p signal-input range for  $V_{DD}-V_{EE} = 15\text{ V}$
- High OFF resistance: channel leakage of  $\pm 100\text{ pA}$  (typ.) @  $V_{DD}-V_{EE} = 18\text{ V}$
- Logic-level conversion for digital addressing signals of 3 to 20 V ( $V_{DD}-V_{SS} = 3$  to 20 V) to switch analog signals to 20 V p-p ( $V_{DD}-V_{EE} = 20\text{ V}$ ); see introductory text
- Matched switch characteristics:  $R_{ON} = 5\ \Omega$  (typ.) for  $V_{DD}-V_{EE} = 15\text{ V}$
- Very low quiescent power dissipation under all digital-control input and supply conditions: 0.2  $\mu\text{W}$  (typ.) @  $V_{DD}-V_{SS} = V_{DD}-V_{EE} = 10\text{ V}$
- Binary address decoding on chip
- 5-, 10-, and 15-V parametric ratings
- 100% tested for quiescent current at 20 V
- Maximum input current of 1  $\mu\text{A}$  at 18 V over full package temperature range; 100 nA at 18 V and 25°C
- Break-before-make switching eliminates channel overlap

### RECOMMENDED OPERATING CONDITIONS AT $T_A = 25^\circ\text{C}$ (Unless Otherwise Specified)

For maximum reliability, nominal operating conditions should be selected so that operation is always within the following ranges. Values shown apply to all types except as noted.

CHARACTERISTIC	$V_{DD}$	Min.	Max.	Units
Supply-Voltage Range ( $T_A =$ Full Package-Temp. Range)	—	3	18	V
Multiplexer Switch Input Current Capability*	—	—	25	mA
Output Load Resistance	—	100	—	$\Omega$

\* In certain applications, the external load-resistor current may include both  $V_{DD}$  and signal-line components. To avoid drawing  $V_{DD}$  current when switch current flows into the transmission gate inputs, the voltage drop across the bidirectional switch must not exceed 0.8 volt (calculated from  $R_{ON}$  values shown in ELECTRICAL CHARACTERISTICS CHART). No  $V_{DD}$  current will flow through  $R_L$  if the switch current flows into terminal 3 on the CD4051; terminals 3 and 13 on the CD4052; terminals 4, 14, and 15 on the CD4053.

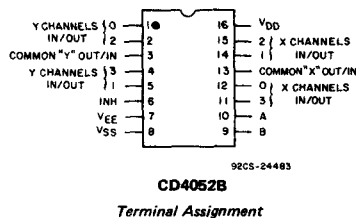
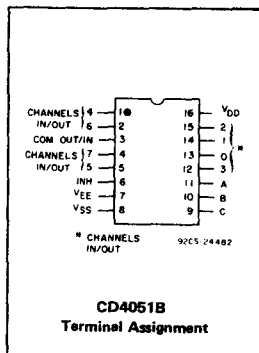

\* When these devices are used as demultiplexers, the "CHANNEL IN/OUT" terminals are the outputs and the "COMMON OUT/IN" terminals are the inputs.

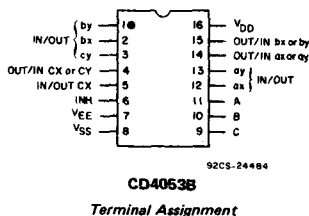



# CD4051B, CD4052B, CD4053B Types

## MAXIMUM RATINGS, Absolute-Maximum Values:

DC SUPPLY-VOLTAGE RANGE, ( $V_{DD}$ ) (Voltages referenced to $V_{SS}$ or $V_{EE}$ , whichever is more negative)	-0.5 to +20 V
INPUT VOLTAGE RANGE, ALL INPUTS	-0.5 to $V_{DD} + 0.5$ V
DC INPUT CURRENT, ANY ONE INPUT	$\pm 10$ mA
POWER DISSIPATION PER PACKAGE ( $P_D$ ):	
For $T_A = -40$ to $+60^\circ\text{C}$ (PACKAGE TYPE E)	500 mW
For $T_A = +60$ to $+85^\circ\text{C}$ (PACKAGE TYPE E)	Derate Linearly at 12 mW/ $^\circ\text{C}$ to 200 mW
For $T_A = -55$ to $+100^\circ\text{C}$ (PACKAGE TYPES D, F, K)	500 mW
For $T_A = +100$ to $+125^\circ\text{C}$ (PACKAGE TYPES D, F, K)	Derate Linearly at 12 mW/ $^\circ\text{C}$ to 200 mW
DEVICE DISSIPATION PER OUTPUT TRANSISTOR	
FOR $T_A =$ FULL PACKAGE-TEMPERATURE RANGE (All Package Types)	100 mW
OPERATING-TEMPERATURE RANGE ( $T_A$ ):	
PACKAGE TYPES D, F, K, H	-55 to $+125^\circ\text{C}$
PACKAGE TYPE E	-40 to $+85^\circ\text{C}$
STORAGE TEMPERATURE RANGE ( $T_{stg}$ )	-65 to $+150^\circ\text{C}$
LEAD TEMPERATURE (DURING SOLDERING):	
At distance $1/16 \pm 1/32$ inch ( $1.59 \pm 0.79$ mm) from case for 10 s max.	$+250^\circ\text{C}$

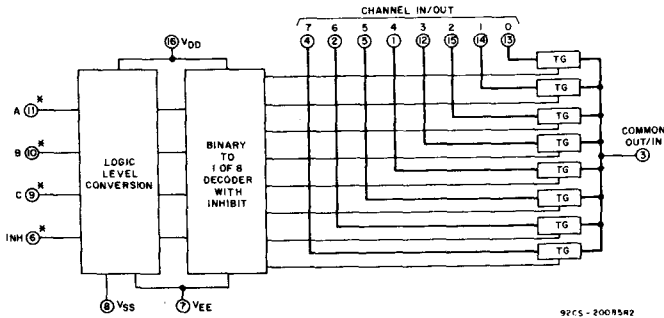

Fig. 1 - Functional diagram of CD4051B.

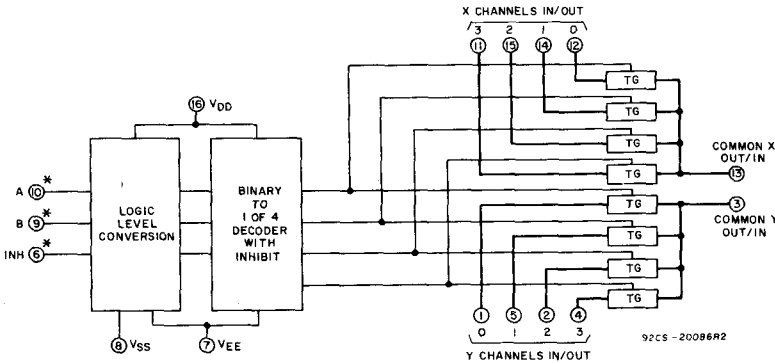

Fig. 2 - Functional diagram of CD4052B.

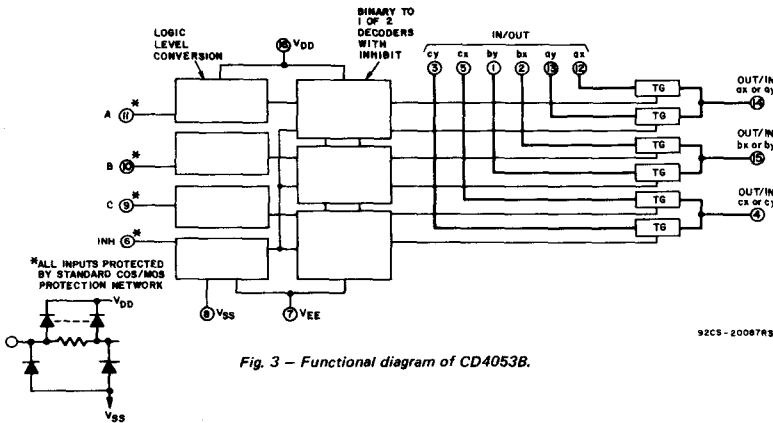

Fig. 3 - Functional diagram of CD4053B.

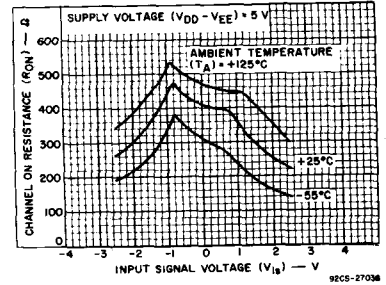

Fig. 4 - Typical channel ON resistance vs. input signal voltage (all types).

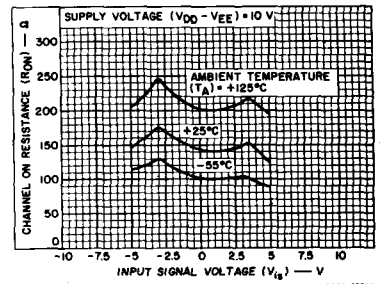

Fig. 5 - Typical channel ON resistance vs. input signal voltage (all types).

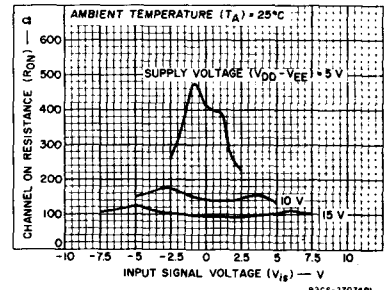

Fig. 6 - Typical channel ON resistance vs. input signal voltage (all types).

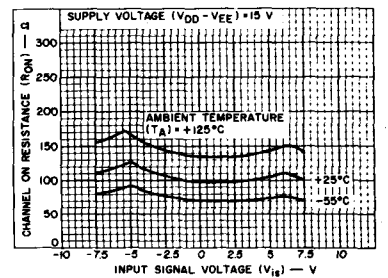

Fig. 7 - Typical channel ON resistance vs. input signal voltage (all types).

# CD4051B, CD4052B, CD4053B Types

## ELECTRICAL CHARACTERISTICS

CHARACTERISTIC	CONDITIONS				LIMITS at Indicated Temperature (°C)						Units		
	V <sub>IS</sub>	V <sub>EE</sub>	V <sub>SS</sub>	V <sub>DD</sub>	Values at -55, +25, +125 Apply to D, F, K, H Pkgs. Values at -40, +25, +85 apply to E pkgs.								
	(V)	(V)	(V)	(V)	-55	-40	+85	+125	+25				
									Min.	Typ.	Max.		
<b>SIGNAL INPUTS (V<sub>IS</sub>) AND OUTPUTS (V<sub>OS</sub>)</b>													
Quiescent Device Current, I <sub>DD</sub> Max.				5	5	5	150	150	-	0.04	5	μA	
				10	10	10	300	300	-	0.04	10		
				15	20	20	600	600	-	0.04	20		
			20	100	100	3000	3000	-	0.08	100			
On-State Resistance 0 < V <sub>IS</sub> < V <sub>DD</sub> r <sub>on</sub> Max.		0	0	5	800	850	1200	1300	-	470	1050	Ω	
		0	0	10	310	330	520	550	-	180	400		
		0	0	15	200	210	300	320	-	125	240		
Change in On-State Resistance (Between Any Two Channels) Δr <sub>on</sub>		0	0	5	-	-	-	-	-	15	-	Ω	
		0	0	10	-	-	-	-	-	10	-		
		0	0	15	-	-	-	-	-	5	-		
OFF Channel Leakage Current:  Any Channel OFF Max. or All Channels OFF (Common OUT/IN) Max.		0	0	18	±100*		±1000*			±0.01	±100*	nA	
Capacitance: Input, C <sub>IS</sub> Output, C <sub>OS</sub> CD4051 CD4052 CD4053  Feedthrough, C <sub>IOS</sub>					-	-	-	-	-	5	-	pF	
					-	-	-	-	-	30	-		
		-5	-5	5	-	-	-	-	-	18	-		
					-	-	-	-	-	9	-		
Propagation Delay Time (Signal Input to Output)	V <sub>DD</sub>	R <sub>I</sub> = 200 kΩ C <sub>L</sub> = 50 pF tr, tf = 20 ns	5	-	-	-	-	-	-	30	60	ns	
			10	-	-	-	-	-	-	-	15		30
			15	-	-	-	-	-	-	-	10		20

\* Determined by minimum feasible leakage measurement for automatic testing.

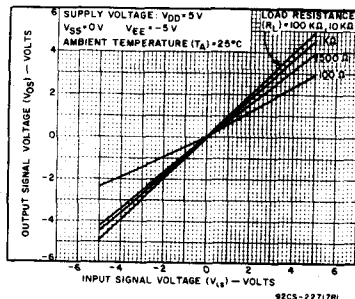

Fig. 8 - Typical ON characteristics for 1 of 8 channels (CD4051B).

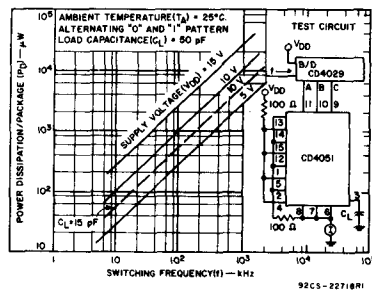

Fig. 9 - Typical dynamic power dissipation vs. switching frequency (CD4051B).

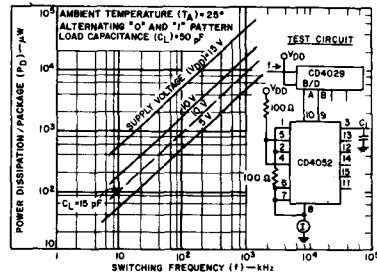

Fig. 10 - Typical dynamic power dissipation vs. switching frequency (CD4052B).

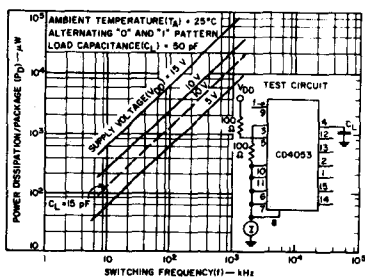
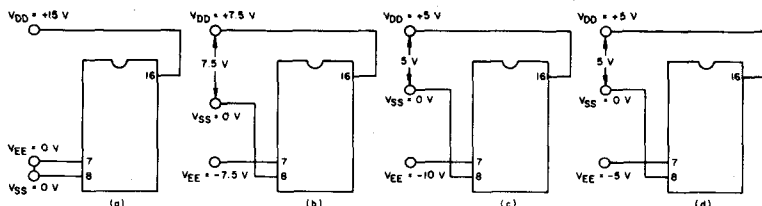

Fig. 11 - Typical dynamic power dissipation vs. switching frequency (CD4053B).



The ADDRESS (digital-control inputs) and INHIBIT logic levels are: "0" = V<sub>SS</sub> and "1" = V<sub>DD</sub>. The analog signal (through the TG) may swing from V<sub>EE</sub> to V<sub>DD</sub>.

Fig. 12 - Typical bias voltages.

# CD4051B, CD4052B, CD4053B Types

## ELECTRICAL CHARACTERISTICS (Cont'd)

CHARACTERISTIC	CONDITIONS				LIMITS at Indicated Temperature (°C)							Units	
	V <sub>is</sub> (V)	V <sub>EE</sub> (V)	V <sub>SS</sub> (V)	V <sub>DD</sub> (V)	Values at -55, +25, +125 Apply to D, F, K, H, Pkg Values at -40, +25, +85, apply to E pkg								
					-55	-40	+85	+125	+25				
											Min.	Typ.	Max.
<b>CONTROL (ADDRESS or INHIBIT) V<sub>C</sub></b>													
Input Low Voltage, V <sub>IL</sub> Max.	=V <sub>DD</sub> thru 1 kΩ	V <sub>EE</sub> =V <sub>SS</sub> R <sub>L</sub> =1 kΩ to V <sub>SS</sub> I <sub>IS</sub> < 2 μA on all OFF Channels	5	1.5	—	—	—	—	—	—	1.5	V	
			10	3	—	—	—	—	—	—	3		
			15	4	—	—	—	—	—	—	4		
Input High Voltage, V <sub>IH</sub> Min.			5	3.5	3.5	—	—	—	—	—			
			10	7	7	—	—	—	—	—			
			15	11	11	—	—	—	—	—			
Input Current, I <sub>IN</sub> Max.	V <sub>IN</sub> = 0, 18		18	±0.1	±0.1	±1	±1	—	±10 <sup>-5</sup>	±0.1	μA		
Propagation Delay Time: Address-to-Signal OUT (Channels ON or OFF) See Figs. 14, 15, 18	t <sub>r</sub> , t <sub>f</sub> = 20 ns, C <sub>L</sub> = 50 pF R <sub>L</sub> = 1 kΩ												
	0	0	5	—	—	—	—	—	450	720	ns		
	0	0	10	—	—	—	—	—	160	320			
	0	0	15	—	—	—	—	—	120	240			
	-5	0	5	—	—	—	—	—	225	450			
Inhibit-to-Signal OUT (Channel turning ON) See Fig. 14	R <sub>L</sub> = 1 kΩ, C <sub>L</sub> = 50 pF t <sub>r</sub> , t <sub>f</sub> = 20 ns												
	0	0	5	—	—	—	—	—	400	720	ns		
	0	0	10	—	—	—	—	—	160	320			
	0	0	15	—	—	—	—	—	120	240			
	-10	0	5	—	—	—	—	—	200	400			
Inhibit-to-Signal OUT (Channel turning OFF) See Fig. 15	R <sub>L</sub> = 1 kΩ, C <sub>L</sub> = 50 pF t <sub>r</sub> , t <sub>f</sub> = 20 ns												
	0	0	5	—	—	—	—	—	200	450	ns		
	0	0	10	—	—	—	—	—	90	210			
	0	0	15	—	—	—	—	—	70	160			
	-10	0	5	—	—	—	—	—	130	300			
Input Capacitance, C <sub>IN</sub> (Any Address or Inhibit Input)									5	7.5	pF		

INPUT STATES				"ON" CHANNEL(S)
INHIBIT	C	B	A	
<b>CD4051B</b>				
0	0	0	0	0
0	0	0	1	1
0	0	1	0	2
0	0	1	1	3
0	1	0	0	4
0	1	0	1	5
0	1	1	0	6
0	1	1	1	7
1	X	X	X	NONE
<b>CD4052B</b>				
INHIBIT	B	A		
0	0	0	0x, 0y	
0	0	1	1x, 1y	
0	1	0	2x, 2y	
0	1	1	3x, 3y	
1	X	X	NONE	
<b>CD4053B</b>				
INHIBIT	A or B or C			
0	0		ax or bx or cx	
0	1		ay or by or cy	
1	X		NONE	

X = Don't care

Fig. 13 - Truth tables.

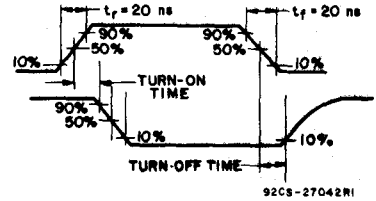

Fig. 14 - Waveforms, channel being turned ON (R<sub>L</sub> = 1 kΩ).

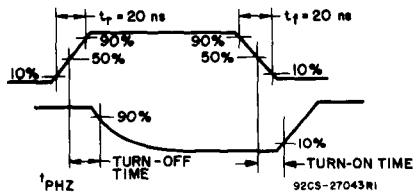

Fig. 15 - Waveforms, channel being turned OFF (R<sub>L</sub> = 1 kΩ).

### TEST CIRCUITS

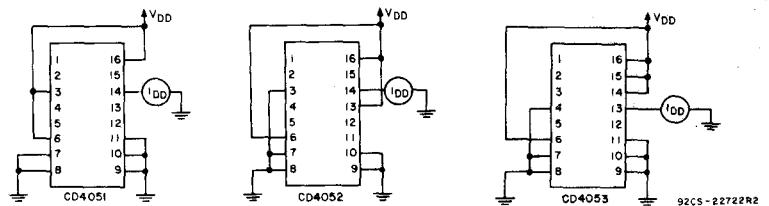

Fig. 16 - OFF channel leakage current - any channel OFF.

# CD4051B, CD4052B, CD4053B Types

## ELECTRICAL CHARACTERISTICS (Cont'd)

CHARACTERISTIC	TEST CONDITIONS			LIMITS		UNITS	
	V <sub>is</sub> (V)	V <sub>DD</sub> (V)	R <sub>L</sub> (kΩ)	TYPICAL VALUE			
Cutoff (-3-dB) Frequency Channel ON (Sine Wave Input)	5 <sup>•</sup>	10	1	CD4053	30	MHz	
	V <sub>EE</sub> = V <sub>SS</sub> .			CD4052	25		
	20 log $\frac{V_{Os}}{V_{is}} = -3\text{ dB}$			CD4051	20		
Total Harmonic Distortion, THD	2 <sup>•</sup>	5	10		0.3	%	
	3 <sup>•</sup>	10			0.2		
	5 <sup>•</sup>	15			0.12		
	V <sub>EE</sub> = V <sub>SS</sub> . f <sub>is</sub> = 1 kHz sine wave						
-40-dB Feedthrough Frequency (All Channels OFF)	5 <sup>•</sup>	10	1	CD4053	8	MHz	
	V <sub>EE</sub> = V <sub>SS</sub> .			CD4052	10		
	20 log $\frac{V_{Os}}{V_{is}} = -40\text{ dB}$			CD4051	12		
-40-dB Signal Crosstalk, Frequency				Between Any 2 Channels		3	MHz
	5 <sup>•</sup>	10	1	Between Sections Measured on Common		6	
	V <sub>EE</sub> = V <sub>SS</sub> .			CD4052 Only Measured on Any Channel		10	
	20 log $\frac{V_{Os}}{V_{is}} = -40\text{ dB}$			Between Any 2 Sections CD4053 Only		In Pin 2, Out Pin 14: 2.5 In Pin 15, Out Pin 14: 6	
Address-or-Inhibit-to Signal Crosstalk	-	10	10 <sup>#</sup>		65	mV (Peak)	
$V_{EE}=0, V_{SS}=0, t_r, t_f = 20\text{ ns}, V_C = V_{DD} - V_{SS}$ (Square Wave)							

• Peak-to-peak voltage symmetrical about  $\frac{V_{DD} - V_{EE}}{2}$

# Both ends of channel

## TEST CIRCUITS (Cont'd)

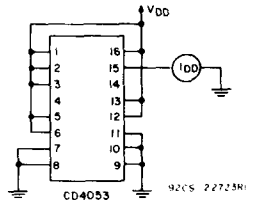
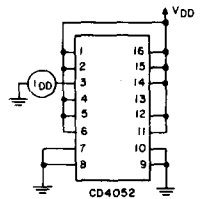
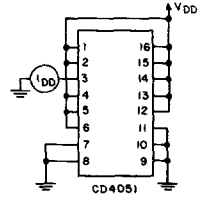

Fig.17 - OFF channel leakage current - all channels OFF.

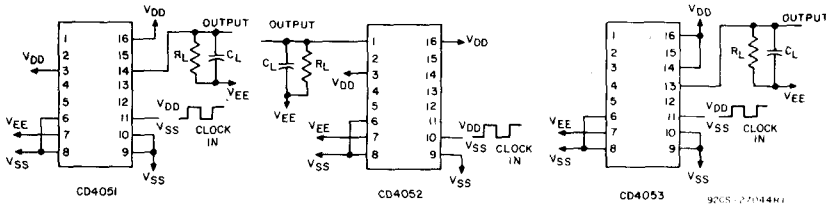

Fig.18 - Propagation delay - address input to signal output.

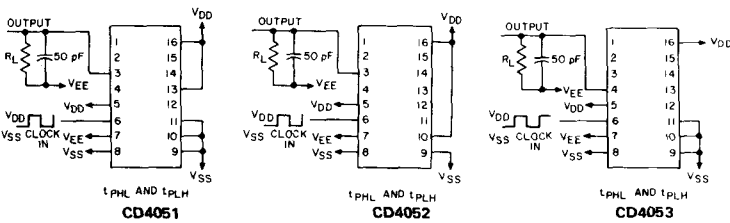

Fig.19 - Propagation delay - inhibit input to signal output.

# CD4051B, CD4052B, CD4053B Types

## TEST CIRCUITS (Cont'd)

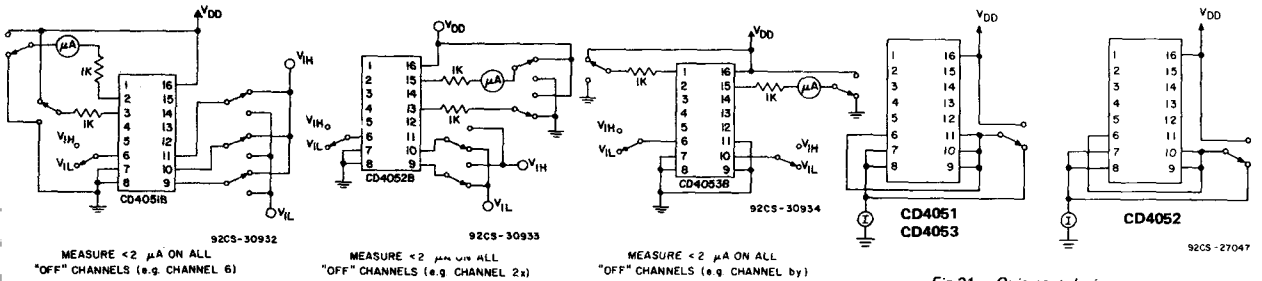

Fig. 20 - Input voltage test circuits (noise immunity).

Fig. 21 - Quiescent device current.

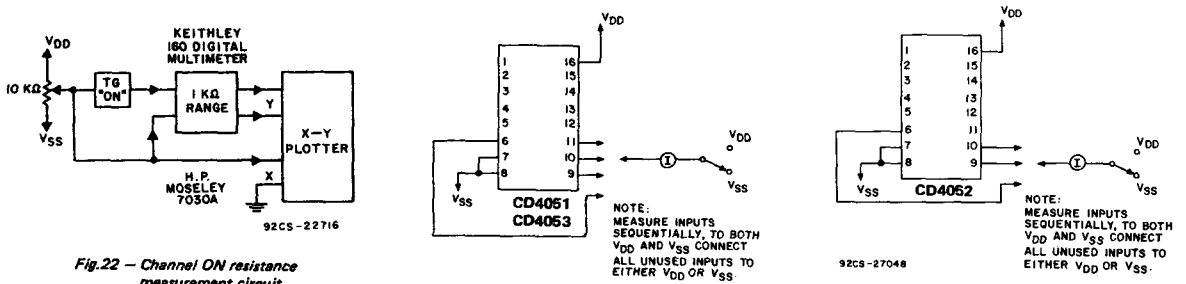

Fig. 22 - Channel ON resistance measurement circuit.

Fig. 23 - Input current.

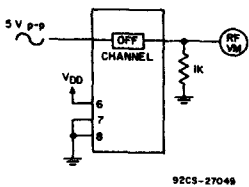

Fig. 24 - Feedthrough (all types).



Fig. 25 - Crosstalk between any two channels (all types).

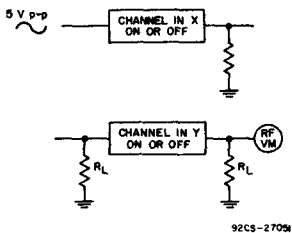

Fig. 26 - Crosstalk between duals or triplets (CD4052B, CD4053B).

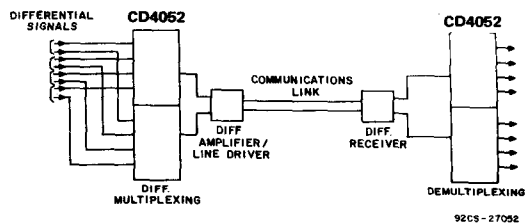
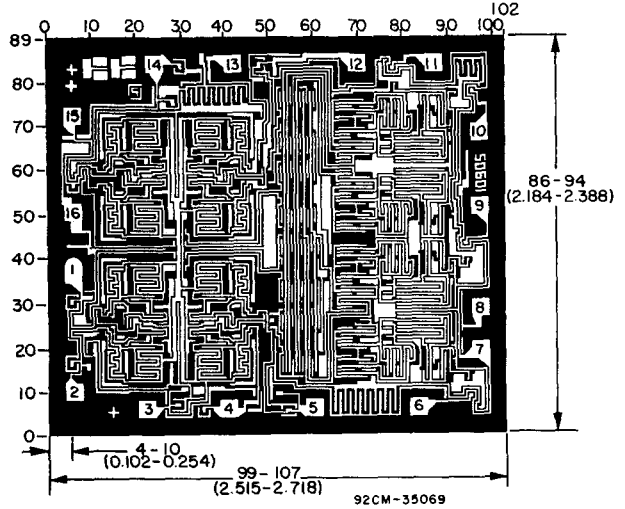

Fig. 27 - Typical time-division application of the CD4052B.

# CD4051B, CD4052B, CD4053B Types

## SPECIAL CONSIDERATIONS

In applications where separate power sources are used to drive  $V_{DD}$  and the signal inputs, the  $V_{DD}$  current capability should exceed  $V_{DD}/R_L$  ( $R_L$  = effective external load). This provision avoids permanent current flow or clamp action on the  $V_{DD}$  supply when power is applied or removed from the CD4051B, CD4052B, or CD4053B.



Dimensions and pad layout for CD4051BH.

The photographs and dimensions of each CMOS chip represent a chip when it is part of the wafer. When the wafer is separated into individual chips, the angle of cleavage may vary with respect to the chip face for different chips. The actual dimensions of the isolated chip, therefore, may differ slightly from the nominal dimensions shown. The user should consider a tolerance of  $-3$  mils to  $+16$  mils applicable to the nominal dimensions shown.

Dimensions in parentheses are in millimeters and are derived from the basic inch dimensions as indicated. Grid Graduations are in Mils ( $10^{-3}$  inch).

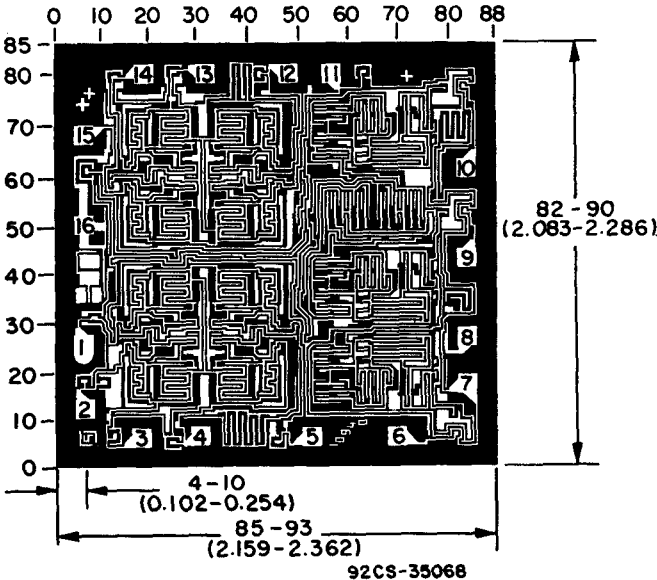

Dimensions and pad layout for CD4052BH.

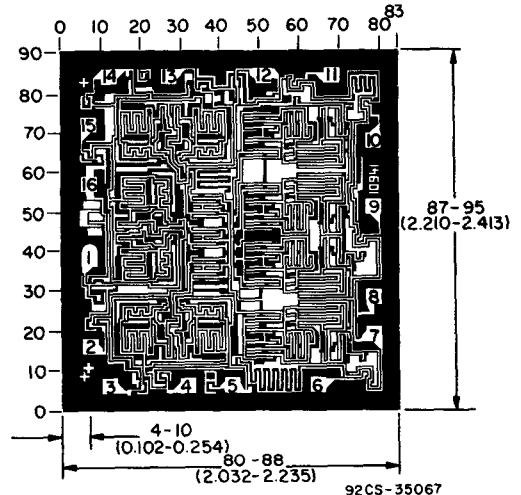

Dimensions and pad layout for CD4053BH.

# CD4054B, CD4055B, CD4056B Types

## CMOS Liquid-Crystal Display Drivers

High-Voltage Types (20-Volt Rating)

CD4054B – 4-Segment Display Driver

CD4055B – BCD to 7-Segment Decoder/Driver with "Display-Frequency" Output

CD4056B – BCD to 7-Segment Decoder/Driver with Strobed-Latch Function

The RCA CD4055B and CD4056B types are single-digit BCD-to-7-segment decoder/driver circuits that provide level-shifting functions on the chip. This feature permits the BCD input-signal swings ( $V_{DD}$  to  $V_{SS}$ ) to be the same as or different from the 7-segment output-signal swings ( $V_{DD}$  to  $V_{EE}$ ). For example, the BCD input-signal swings ( $V_{DD}$  to  $V_{SS}$ ) may be as small as 0 to  $-3$  V, whereas the output-display drive-signal swing ( $V_{DD}$  to  $V_{EE}$ ) may be as large as from 0 to  $-15$  V. If  $V_{DD}$  to  $V_{EE}$  exceeds 15 V,  $V_{DD}$  to  $V_{SS}$  should be at least 4V (0 to  $-4$ V).

The 7-segment outputs are controlled by the DISPLAY-FREQUENCY (DF) input which causes the selected segment outputs to be low, high, or a square-wave output (for liquid-crystal displays). When the DF input is low the output segments will be high when selected by the BCD inputs. When the DF input is high, the output segments will be low when selected by the BCD inputs. When a square-wave is present at the DF input, the selected segments will have a square-wave output that is 180° out of phase with the DF input. Those segments which are not selected will have a square-wave output that is in phase with the input. DF square-wave repetition rates for liquid-crystal displays usually range from 30 Hz (well above flicker rate) to 200 Hz (well below the upper limit of the liquid-crystal frequency response). The CD4055B provides a level-shifted high-amplitude DF output which is required for driving the common electrode in liquid-crystal displays. The CD4056B provides a strobed-latch function at the BCD inputs. Decoding of all input combinations on the CD4055B and CD4056B provides displays of 0 to 9 as well as L, P, H, A,  $-$ , and a blank position.

The CD4054B provides level shifting similar to the CD4055B and CD4056B independently strobed latches, and common DF control on 4 signal lines. The CD4054B is intended to provide drive-signal compatibility with the CD4055B and CD4056B 7-segment decoder types for the decimal point, colon, polarity, and similar display lines. A level-shifted high-amplitude DF output can be obtained from any CD4054B output line by connect-

### Features:

- Operation of liquid crystals with CMOS circuits provides ultra-low-power displays
- Equivalent ac output drive for liquid-crystal displays – no external capacitor required
- Voltage doubling across display, e.g.  $V_{DD} - V_{EE} = 18$  V results in effective 36 V p-p drive across selected display segments
- Low- or high-output level dc drive for other types of displays
- On-chip logic-level conversion for different input- and output-level swings
- Full decoding of all input combinations: 0-9, L, H, P, A,  $-$ , and blank positions
- Strobed-latch function—CD4054B Series and CD4056B Series
- DISPLAY-FREQUENCY (DF) output for liquid-crystal common-line drive signal—CD4055B Series (CD4054B Series also; see introductory text)
- 100% tested for quiescent current at 20 V over full package temperature range; 100 nA at 18 V and 25°C
- Noise margin (over full package temperature range):
  - 1 V at  $V_{DD} = 5$  V
  - 2 V at  $V_{DD} = 10$  V
  - 2.5 V at  $V_{DD} = 15$  V
- 5-V, 10-V, and 15-V parametric ratings

### Applications

- General-purpose displays
- Calculators and meters
- Wall and table clocks
- Industrial control panels
- Portable lab instruments
- Panel meters
- Auto dashboard displays
- Appliance control panels

ing the corresponding input and strobe lines to a low and high level, respectively and applying a square wave to DF<sub>IN</sub>. The CD4054B may also be utilized for logic-level "up conversion" or "down conversion". For example, input-signal swings ( $V_{DD}$  to  $V_{SS}$ ) from +5 to 0 V can be converted to output-signal swings ( $V_{DD}$  to  $V_{EE}$ ) of +5 to  $-5$  V. The level-shifted function on all three types permits the use of different input- and output-signal swings. The input swings from a low level of  $V_{SS}$  to a high level of  $V_{DD}$  while the output swings from a low level of  $V_{EE}$  to the same high level of  $V_{DD}$ . Thus, the input and output swings can be selected independently of each other over a 3-to-18 V range.  $V_{SS}$  may be connected to  $V_{EE}$  when no level-shift function is required.

For the CD4054B and CD4056B, data are

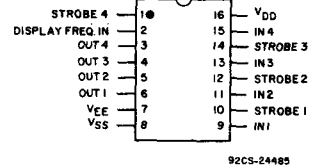
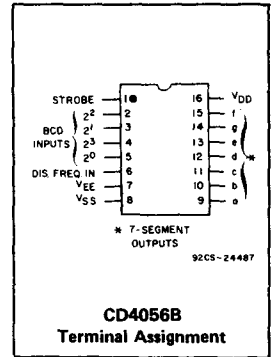

CD4054B Terminal Assignment

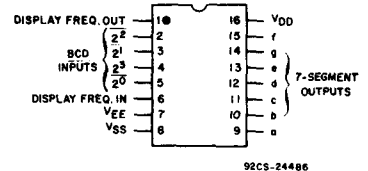

CD4055B Terminal Assignment

transferred from input to output by placing a high voltage level at the strobe input. A low voltage level at the strobe input latches the data input and the corresponding output segments remain selected (or non-selected) while the strobe is low.

Whenever the level-shifting function is required, the CD4055B can be used by itself to drive a liquid-crystal display (Fig. 16 and Fig. 20). The CD4056B, however, must be used together with a CD4054B to provide the common DF output (Fig. 19). The capability of extending the voltage swing on the negative end (this voltage cannot be extended on the positive end) can be used to advantage in the setup of Fig. 18. Fig. 17 is common to all three types.

The CD4054B-, CD4055B-, and CD4056B-series types are available in 16-lead ceramic dual-in-line packages (D and F suffixes), 16-lead plastic packages (E suffix), 16-lead ceramic flat packages (K suffix), and in chip form (H suffix).

# CD4054B, CD4055B, CD4056B Types

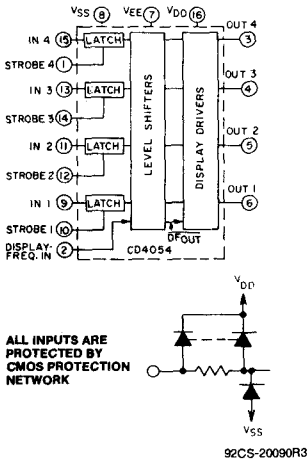

Fig. 1 - CD4054B functional diagram.

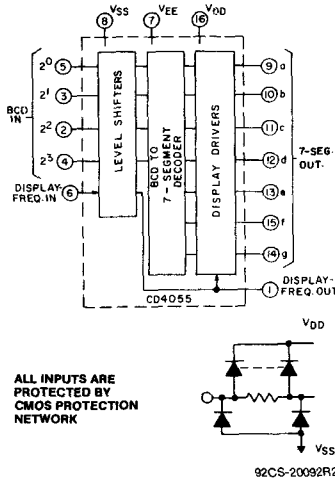

Fig. 2 - CD4055B functional diagram.

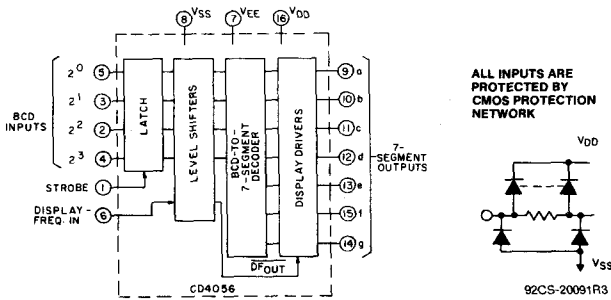

Fig. 3 - CD4056B functional diagram.

## TRUTH TABLE FOR CD4055B and CD4056B

INPUT CODE				OUTPUT STATE							DISPLAY CHARACTER
2 <sup>3</sup>	2 <sup>2</sup>	2 <sup>1</sup>	2 <sup>0</sup>	a	b	c	d	e	f	g	
0	0	0	0	1	1	1	1	1	1	0	□
0	0	0	1	0	1	1	0	0	0	0	□
0	0	1	0	1	1	1	0	1	1	0	□
0	0	1	1	1	1	1	1	1	0	0	□
0	1	0	0	0	1	1	0	0	1	1	□
0	1	0	1	1	0	1	1	0	1	1	□
0	1	1	0	1	0	1	1	1	1	1	□
0	1	1	1	1	1	1	1	0	0	0	□
1	0	0	0	1	1	1	1	1	1	1	□
1	0	0	1	1	1	1	1	0	1	1	□
1	0	1	0	0	0	0	1	1	1	0	□
1	0	1	1	0	1	1	0	1	1	1	□
1	1	0	0	1	1	1	0	0	1	1	□
1	1	0	1	1	1	1	0	1	1	1	□
1	1	1	0	0	0	0	0	0	0	1	□
1	1	1	1	0	0	0	0	0	0	0	BLANK

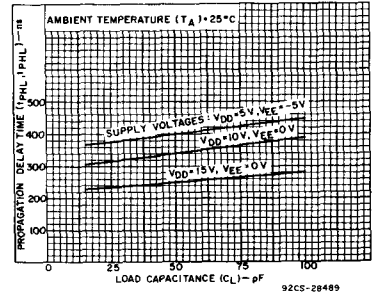

Fig. 4 - Typical propagation delay time vs. load capacitance for CD4054B.

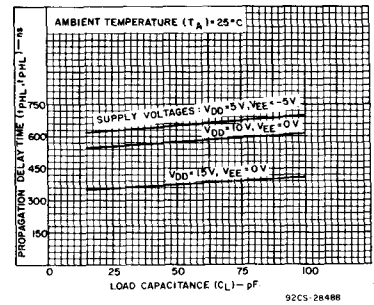

Fig. 5 - Typical propagation delay time vs. load capacitance for CD4055 and CD4056B.

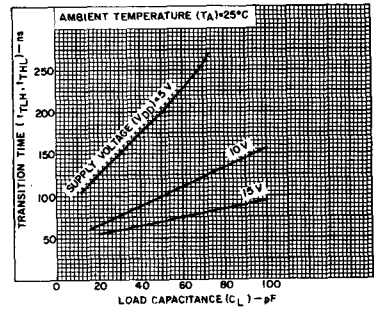

Fig. 6 - Typical transition time vs. load capacitance.

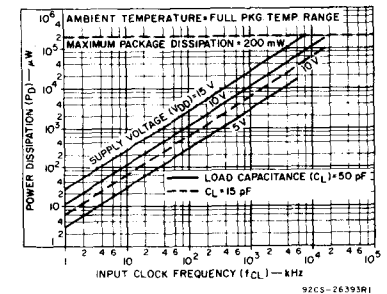

Fig. 7 - Typical input clock frequency vs. power dissipation.



# CD4054B, CD4055B, CD4056B Types

## MAXIMUM RATINGS, Absolute-Maximum Values:

DC SUPPLY-VOLTAGE RANGE, ( $V_{DD}$ ) (Voltages referenced to $V_{SS}$ Terminal)	-0.5 to +20 V
INPUT VOLTAGE RANGE, ALL INPUTS	-0.5 to $V_{DD} + 0.5$ V
DC INPUT CURRENT, ANY ONE INPUT	$\pm 10$ mA
POWER DISSIPATION PER PACKAGE ( $P_D$ ):	
For $T_A = -40$ to $+60^\circ\text{C}$ (PACKAGE TYPE E)	500 mW
For $T_A = +60$ to $+85^\circ\text{C}$ (PACKAGE TYPE E)	Derate Linearly at 12 mW/ $^\circ\text{C}$ to 200 mW
For $T_A = -55$ to $+100^\circ\text{C}$ (PACKAGE TYPES D, F, K)	500 mW
For $T_A = +100$ to $+125^\circ\text{C}$ (PACKAGE TYPES D, F, K)	Derate Linearly at 12 mW/ $^\circ\text{C}$ to 200 mW
DEVICE DISSIPATION PER OUTPUT TRANSISTOR:	
For $T_A = \text{FULL PACKAGE-TEMPERATURE RANGE}$ (All Package Types)	100 mW
OPERATING-TEMPERATURE RANGE ( $T_A$ ):	
PACKAGE TYPES D, F, K, H	-55 to $+125^\circ\text{C}$
PACKAGE TYPE E	-40 to $+85^\circ\text{C}$
STORAGE TEMPERATURE RANGE ( $T_{stg}$ )	-65 to $+150^\circ\text{C}$
LEAD TEMPERATURE (DURING SOLDERING):	
At distance 1/16 $\pm$ 1/32 inch (1.59 $\pm$ 0.79 mm) from case for 10 s max.	$+265^\circ\text{C}$

## STATIC ELECTRICAL CHARACTERISTICS

Characteristic	CONDITIONS					LIMITS							Units	
	$V_{EE}$ (V)	$V_{SS}$ (V)	$V_O$ (V)	$V_{IN}$ (V)	$V_{DD}$ (V)	Values at $-55, +25, +125$ Apply to D, F, K, H, Packages Values at $-40^\circ, +25^\circ, +85^\circ\text{C}$ Apply to E Package								
						$-55^\circ$	$-40^\circ$	$+85^\circ$	$+125^\circ$	$+25^\circ\text{C}$				
											Min.	Typ.	Max.	
Quiescent Device Current, $I_{DD}$ MAX.	-5	0			5	5	150	150	-	0.04	5	$\mu\text{A}$		
	0	0			10	10	300	300	-	0.04	10			
	0	0			15	20	600	600	-	0.04	20			
	0	0			20	100	3000	3000	-	0.08	100			
Output Voltage: Low Level, $V_{OL}$ MAX.	0	0		0.5	5		0.05		-	0	0.05	V		
	0	0		0.10	10		0.05		-	0	0.05			
	0	0		0.15	15		0.05		-	0	0.05			
	0	0		0.5	5		4.95		4.95	5	-			
High Level, $V_{OH}$ MIN.	0	0		0.10	10		9.95		9.95	10	-	V		
	0	0		0.15	15		14.95		14.95	15	-			
	0	0	0.5											
	0	0	4.5		5		1.5		-	-	1.5			
Input Low Voltage, $V_{IL}$ MAX.	0	0	1.9		10		3		-	-	3	V		
	0	0	1.5, 13.5		15		4		-	-	4			
	-5	0	0.5, 4.5		5		3.5		3.5	-	-			
	0	0	1.9		10		7		7	-	-			
Input High Voltage, $V_{IH}$ MIN.	0	0	1.5, 13.5		15		11		11	-	-	V		
	-5	0	-4.5		5	0.98	0.92	0.67	0.55	0.8	1.6		mA	
	0	0	0.5		10	0.98	0.92	0.67	0.55	0.8	1.6			
	0	0	1.5		15	3.6	3.4	2.4	2	2.9	5.8			
Output Low (Sink) Current, $I_{OL}$	-5	0	4.5		5	-0.6	-0.55	-0.35	-0.3	-0.45	-0.9	mA		
	0	0	9.5		10	-0.6	-0.55	-0.35	-0.3	-0.45	-0.9			
	0	0	13.5		15	-1.9	-1.8	-1.2	-1.1	-1.5	-3			
	0	0												
Output High (Source) Current, $I_{OH}$	-5	0			5							mA		
	0	0			10									
Input Current, $I_{IN}$	0	0			0, 18	$\pm 0.1$	$\pm 0.1$	$\pm 1$	$\pm 1$	-	$\pm 10^{-5}$	$\mu\text{A}$		

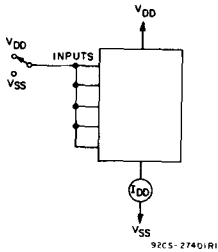

Fig. 11 - Quiescent-device-current test circuit.

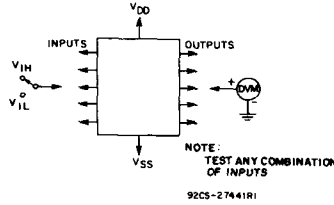

Fig. 12 - Input-voltage test circuit.

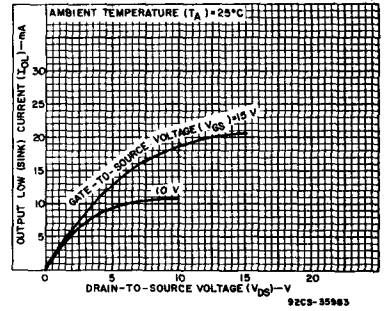

Fig. 8 - Typical n-channel output low (sink) current characteristics.

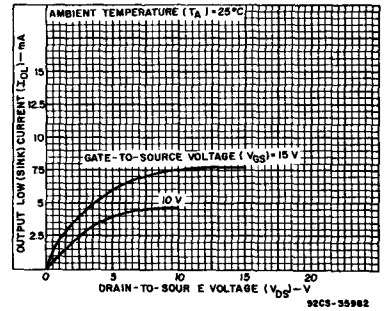

Fig. 9 - Minimum n-channel output low (sink) current characteristics.

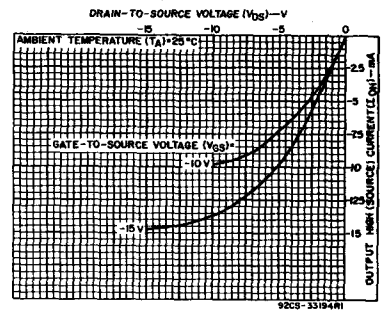

Fig. 10 - Typical p-channel output high (source) current characteristics.

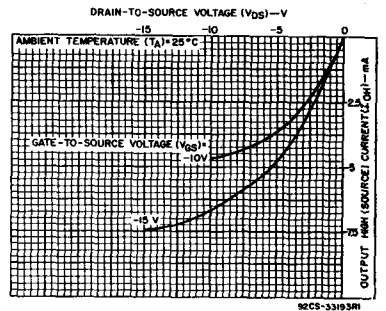

Fig. 13 - Minimum p-channel output high (source) current characteristics.

# CD4054B, CD4055B, CD4056B Types

DYNAMIC ELECTRICAL CHARACTERISTICS at  $T_A = 25^\circ\text{C}$ ,  $C_L = 50\text{ pF}$ , Input  $t_r, t_f = 20\text{ ns}$ ,  $R_L = 200\text{ k}\Omega$

CHARACTERISTIC	CONDITIONS			LIMITS				UNITS
	VEE (V)	VSS (V)	VDD (V)	ALL PACKAGE TYPES				
				CD4054		CD4055, CD4056		
Typ.	Max.	Typ.	Max.	Typ.	Max.	Typ.	Max.	
Propagation Delay Time, $t_{PHL}, t_{PLH}$ (Any Input to Any Output)	-5	0	5	400	800	650	1300	ns
	0	0	10	340	680	575	1150	
	0	0	15	250	500	375	750	
Transition Time, $t_{THL}, t_{TLH}$ (Any Output)	-5	0	5	100	200	100	200	ns
	0	0	10	100	200	100	200	
	0	0	15	75	150	75	150	
Minimum Data Setup Time, $t_S^*$	-5	0	5	110	220	110	220	ns
	0	0	10	50	100	50	100	
			15	35	70	35	70	
Minimum Strobe Pulse Width, $t_W^*$	-5	0	5	110	220	110	220	ns
	0	0	10	50	100	50	100	
	0	0	15	35	70	35	70	
Input Capacitance, $C_{IN}$ (Any Input)	-	-	-	5	7.5	5	7.5	pF

\* CD4054 and CD4056 only.

**RECOMMENDED OPERATING CONDITIONS at  $T_A = 25^\circ\text{C}$  (Unless otherwise specified)**  
For maximum reliability, nominal operating conditions should be selected so that operation is always within the following ranges.

CHARACTERISTIC	VEE (V)	VSS (V)	VDD (V)	LIMITS		UNITS
				Min.	Max.	
Supply Voltage Range: (At $T_A = \text{Full Package Temperature Range}$ )				3	18	V
Setup Time ( $t_S$ ) <sup>•</sup>	-5	0	5	220	—	ns
	0	0	10	100	—	
	0	0	15	70	—	
Strobe Pulse Width ( $t_W$ ) <sup>•</sup>	-5	0	5	220	—	ns
	0	0	10	100	—	
	0	0	15	70	—	

• For CD4054 and CD4056 only.

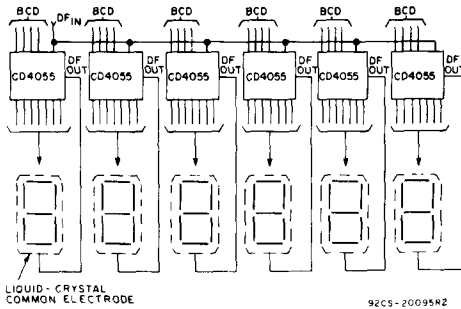

Fig. 16 - Clock display:  $V_{DD} = 0\text{ V}$ ,  $V_{SS} = -5\text{ V}$ ,  $V_{EE} = -15\text{ V}$ ,  $DF_{IN} = 30\text{ Hz}$  square wave.

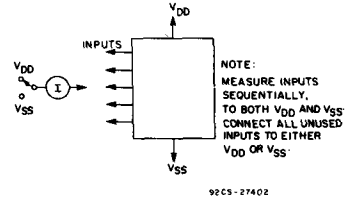

Fig. 14 - Input-current test circuit.

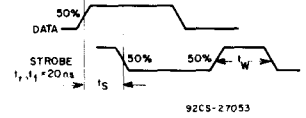

Fig. 15 - Data setup time and strobe pulse duration.

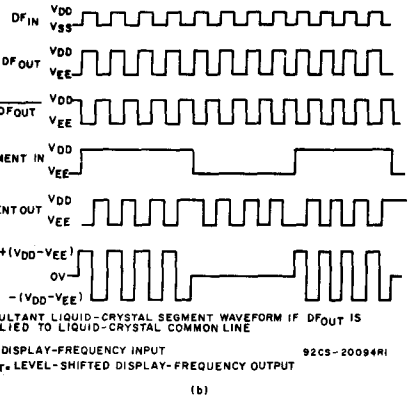
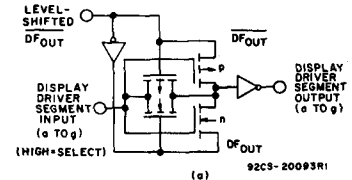

Fig. 17 - Display-driver circuit for one segment line and waveforms.

# CD4054B, CD4055B, CD4056B Types

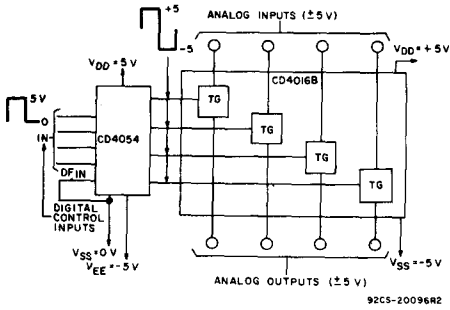

Fig.18 - Digital (0 to +5 V) to bidirectional analog control (+5 to -5 V) level shifter.

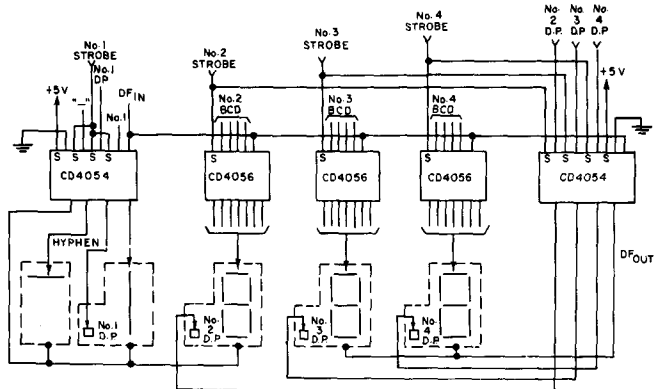

Fig.19 - Typical 3 1/2-digit liquid-crystal display:  $V_{DD} = +5\text{ V}$ ,  $V_{SS} = 0\text{ V}$ ,  $V_{EE} = -10\text{ V}$ ,  $DF_{IN} = 30\text{ Hz}$  square wave.

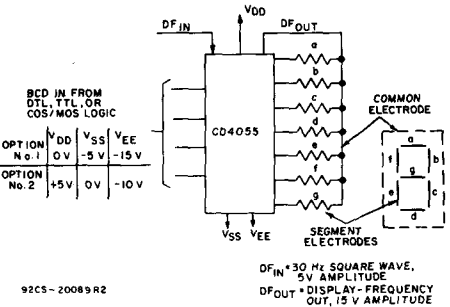

Fig.20 - Single-digit liquid-crystal display.

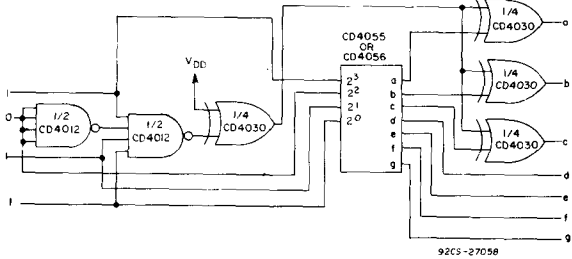
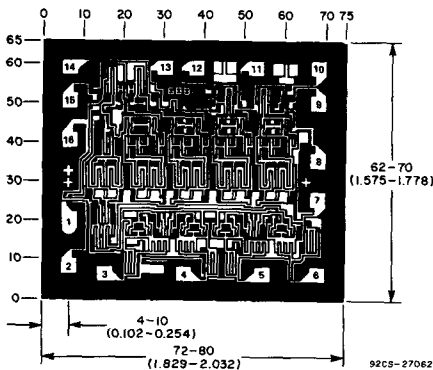

Fig.21 - Conversion of "H" display to "F" display.

The photographs and dimensions of each CMOS chip represent a chip when it is part of the wafer. When the wafer is separated into individual chips, the angle of cleavage may vary with respect to the chip face for different chips. The actual dimensions of the isolated chip, therefore, may differ slightly from the nominal dimensions shown. The user should consider a tolerance of -3 mils to +16 mils applicable to the nominal dimensions shown.

Dimensions in parentheses are in millimeters and are derived from the basic inch dimensions as indicated. Grid graduations are in mils ( $10^{-3}$  inch).



Dimensions and pad layout for CD4054BH.

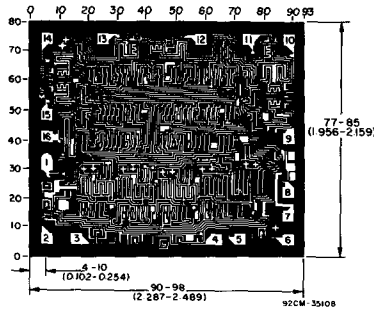

Dimensions and pad layout for CD4055BH

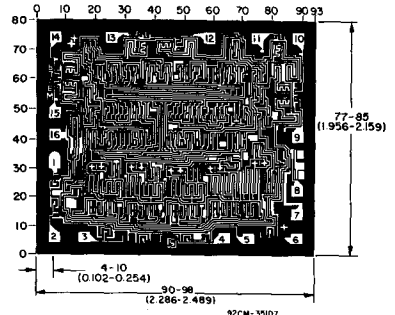

Dimensions and pad layout for CD4056BH

In addition to the letters L, H, P, and A (See the truth table), five other letters can be displayed through the use of simple logic circuits preceding and following the CD4055B or CD4056B devices. Fig.21 is an example of a circuit that converts an "H" display (code 1011) to an "F" display. One condition that must be met is that  $V_{EE} = V_{SS}$ . If  $V_{EE} \neq V_{SS}$ , the CD4054B must be used to level shift in the appropriate places.

In a similar manner the letters C, E, J, and U can be displayed. These circuits can also be used to drive LED displays provided the exclusive-OR gates have sufficient output-current drive.

The letters B, D, G, I, O, and S may be represented by the codes for numbers 8, 0, 6, 1, 0, and 5, respectively, when there is pre-knowledge that only letters are to be displayed.

# CD4060B Types

## CMOS 14-Stage Ripple-Carry Binary Counter/Divider and Oscillator

High-Voltage Types (20-Volt Rating)

The RCA-CD4060B consists of an oscillator section and 14 ripple-carry binary counter stages. The oscillator configuration allows design of either RC or crystal oscillator circuits. A RESET input is provided which resets the counter to the all-0's state and disables the oscillator. A high level on the RESET line accomplishes the reset function. All counter stages are master-slave flip-flops. The state of the counter is advanced one step in binary order on the negative transition of  $\phi I$  (and  $\phi O$ ). All inputs and outputs are fully buffered. Schmitt trigger action on the input-pulse line permits unlimited input-pulse rise and fall times.

The CD4060B-series types are supplied in 16-lead hermetic dual-in-line ceramic packages (D and F suffixes), 16-lead dual-in-line plastic packages (E suffix), 16-lead ceramic flat packages (K suffix), and in chip form (H suffix).

### Features:

- 12 MHz clock rate at 15 V
- Common reset
- Fully static operation
- Buffered inputs and outputs
- Schmitt trigger input-pulse line
- 100% tested for quiescent current at 20 V
- Standardized, symmetrical output characteristics
- 5-V, 10-V, and 15-V parametric ratings
- Meets all requirements of JEDEC Tentative Standard No. 13B, "Standard Specifications for description of "B" Series CMOS Devices"

### Oscillator Features:

- All active components on chip
- RC or crystal oscillator configuration
- RC oscillator frequency of 690 kHz min. at 15 V

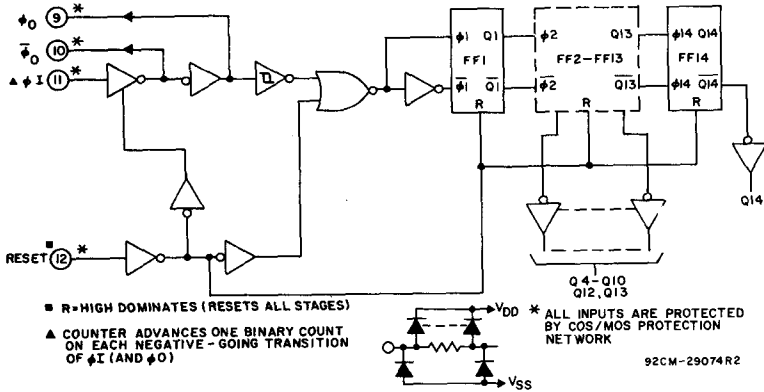
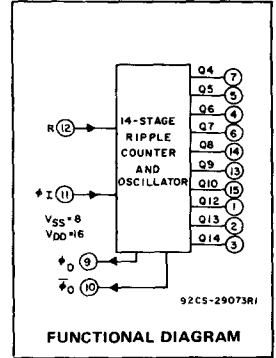

Fig. 1 - Logic diagram.

### MAXIMUM RATINGS, Absolute-Maximum Values:

DC SUPPLY-VOLTAGE RANGE, ( $V_{DD}$ ) (Voltages referenced to $V_{SS}$ Terminal)	-0.5 to +20 V
INPUT VOLTAGE RANGE, ALL INPUTS	-0.5 to $V_{DD}$ + 0.5 V
DC INPUT CURRENT, ANY ONE INPUT	$\pm 10$ mA
POWER DISSIPATION PER PACKAGE ( $P_D$ ):	
For $T_A = -40$ to $+60^\circ\text{C}$ (PACKAGE TYPE E)	500 mW
For $T_A = +60$ to $+85^\circ\text{C}$ (PACKAGE TYPE E)	Derate Linearly at 12 mW/ $^\circ\text{C}$ to 200 mW
For $T_A = -55$ to $+100^\circ\text{C}$ (PACKAGE TYPES D, F, K)	500 mW
For $T_A = +100$ to $+125^\circ\text{C}$ (PACKAGE TYPES D, F, K)	Derate Linearly at 12 mW/ $^\circ\text{C}$ to 200 mW
DEVICE DISSIPATION PER OUTPUT TRANSISTOR FOR $T_A$ - FULL PACKAGE-TEMPERATURE RANGE (All Package Types)	100 mW
OPERATING-TEMPERATURE RANGE ( $T_A$ ):	
PACKAGE TYPES D, F, K, H	-55 to $+125^\circ\text{C}$
PACKAGE TYPE E	-40 to $+85^\circ\text{C}$
STORAGE TEMPERATURE RANGE ( $T_{STG}$ )	-65 to $+150^\circ\text{C}$
LEAD TEMPERATURE (DURING SOLDERING) At distance 1/16 $\pm$ 1/32 inch (1.59 $\pm$ 0.79 mm) from case for 10 s max.	$+265^\circ\text{C}$

### Applications

- Control counters
- Timers
- Frequency dividers
- Time-delay circuits

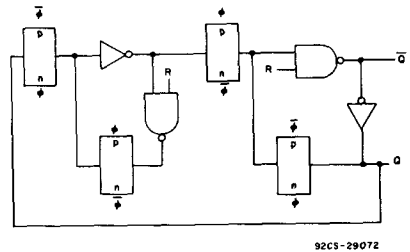

Fig. 2 - Detail of typical flip-flop stage.

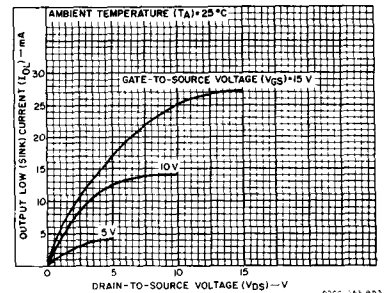

Fig. 3 - Typical n-channel output low (sink) current characteristics.

# CD4060B Types

## STATIC ELECTRICAL CHARACTERISTICS

CHARACTERISTIC	CONDITIONS			LIMITS AT INDICATED TEMPERATURES (°C)							UNITS
	V <sub>O</sub> (V)	V <sub>IN</sub> (V)	V <sub>DD</sub> (V)	Values at -55, +25, +125 Apply to D, F, K, H, Packages Values at -40, +25, +85 Apply to E Package				+25			
				-55	-40	+85	+125	Min.	Typ.	Max.	
Quiescent Device Current, I <sub>DD</sub> Max.	—	0,5	5	5	5	150	150	—	0,04	5	μA
	—	0,10	10	10	10	300	300	—	0,04	10	
	—	0,15	15	20	20	600	600	—	0,04	20	
	—	0,20	20	100	100	3000	3000	—	0,08	100	
Output Low (Sink) Current*, I <sub>OL</sub> Min.	0,4	0,5	5	0,64	0,61	0,42	0,36	0,51	1	—	mA
	0,5	0,10	10	1,6	1,5	1,1	0,9	1,3	2,6	—	
	1,5	0,15	15	4,2	4	2,8	2,4	3,4	6,8	—	
Output High (Source) Current*, I <sub>OH</sub> Min.	4,6	0,5	5	-0,64	-0,61	-0,42	-0,36	-0,51	-1	—	mA
	2,5	0,5	5	-2	-1,8	-1,3	-1,15	-1,6	-3,2	—	
	9,5	0,10	10	-1,6	-1,5	-1,1	-0,9	-1,3	-2,6	—	
Output Voltage: Low-Level, V <sub>OL</sub> Max.	—	0,5	5	0,05				—	0	0,05	V
	—	0,10	10	0,05				—	0	0,05	
	—	0,15	15	0,05				—	0	0,05	
Output Voltage: High-Level, V <sub>OH</sub> Min.	—	0,5	5	4,95				4,95	5	—	V
	—	0,10	10	9,95				9,95	10	—	
	—	0,15	15	14,95				14,95	15	—	
Input Low Voltage V <sub>IL</sub> Max.	0,5, 4,5	—	5	1,5				—	—	1,5	V
	1,9	—	10	3				—	—	3	
	1,5, 13,5	—	15	4				—	—	4	
Input High Voltage, V <sub>IH</sub> Min.	0,5, 4,5	—	5	3,5				3,5	—	—	V
	1,9	—	10	7				7	—	—	
	1,5, 13,5	—	15	11				11	—	—	
Input Current I <sub>IN</sub> Max.	—	0,18	18	±0,1	±0,1	±1	±1	—	±10 <sup>-5</sup>	±0,1	μA

\* Data not applicable to terminal 9 or 10.

## RECOMMENDED OPERATING CONDITIONS

For maximum reliability, nominal operating conditions should be selected so that operation is always within the following ranges

CHARACTERISTIC	V <sub>DD</sub>	LIMITS		UNITS
		MIN.	MAX.	
Supply-Voltage Range (For T <sub>A</sub> = Full Package Temperature Range)	—	3	18	V
Input-Pulse Width, t <sub>W</sub> (f = 100 kHz)	5	100	—	ns
	10	40	—	
	15	30	—	
Input-Pulse Rise Time and Fall Time, t <sub>rφ</sub> , t <sub>fφ</sub>	5	Unlimited		
	10			
	15			
Input-Pulse Frequency, f <sub>φI</sub> (External pulse source)	5	—	3,5	MHz
	10	—	8	
	15	—	12	
Reset Pulse Width, t <sub>W</sub>	5	120	—	ns
	10	60	—	
	15	40	—	

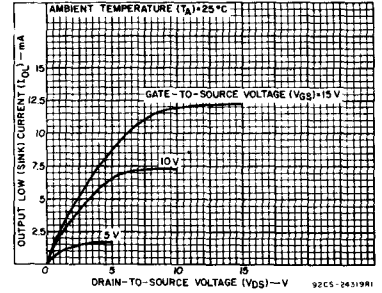

Fig. 4 - Minimum n-channel output low (sink) current characteristics.

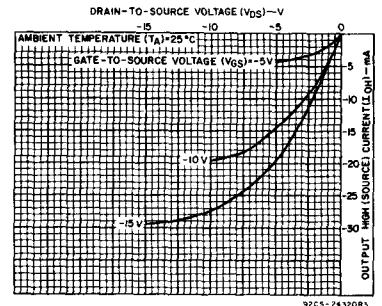

Fig. 5 - Typical p-channel output high (source) current characteristics.

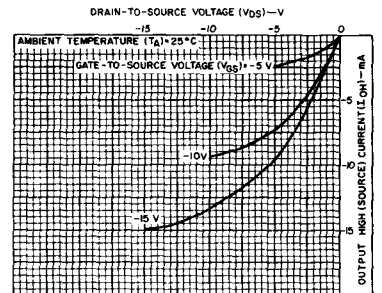

Fig. 6 - Minimum p-channel output high (source) current characteristics.

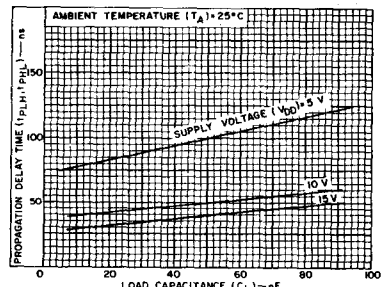

Fig. 7 - Typical propagation delay time (Q<sub>n</sub> to Q<sub>n+1</sub>) as a function of load capacitance.

# CD4060B Types

DYNAMIC ELECTRICAL CHARACTERISTICS at  $T_A = 25^\circ\text{C}$ , Input  $t_r, t_f = 20\text{ ns}$ ,  $C_L = 50\text{ pF}$ ,  $R_L = 200\text{ k}\Omega$

CHARACTERISTIC	TEST CONDITIONS	LIMITS			UNITS	
		V <sub>DD</sub> (V)	MIN.	TYP.		MAX.
<b>Input-Pulse Operation</b>						
Propagation Delay Time, $\phi_I$ to Q4 Out; $t_{PHL}, t_{PLH}$		5	—	370	740	
		10	—	150	300	
		15	—	100	200	
Propagation Delay Time, $Q_n$ to $Q_{n+1}$ ; $t_{PHL}, t_{PLH}$		5	—	100	200	
		10	—	50	100	
		15	—	40	80	
Transition Time, $t_{THL}, t_{TLH}$		5	—	100	200	ns
		10	—	50	100	
		15	—	40	80	
Min. Input-Pulse Width, $t_{Wp}$	$f = 100\text{ kHz}$	5	—	50	100	
		10	—	20	40	
		15	—	15	30	
Input-Pulse Rise & Fall Time, $t_{r\phi}, t_{f\phi}$		5	Unlimited			
		10				
		15				
Max. Input-Pulse Frequency, $f_{\phi I}$ (External pulse source)		5	3.5	7	—	MHz
		10	8	16	—	
		15	12	24	—	
Input Capacitance, $C_I$	Any Input	—	5	7.5	pF	
<b>Reset Operation</b>						
Propagation Delay Time, $t_{PHL}$		5	—	180	360	ns
		10	—	80	160	
		15	—	50	100	
Minimum Reset Pulse Width, $t_{Wp}$		5	—	60	120	
		10	—	30	60	
		15	—	20	40	

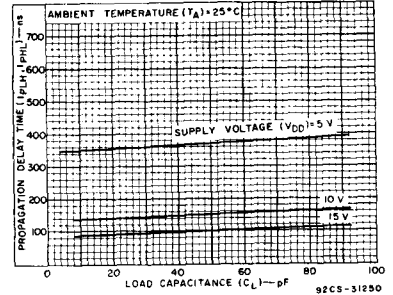

Fig. 8 — Typical propagation delay time ( $\phi_I$  to  $Q_4$  Output) as a function of load capacitance.

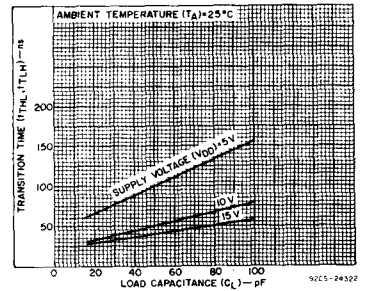

Fig. 9 — Typical transition time as a function of load capacitance.

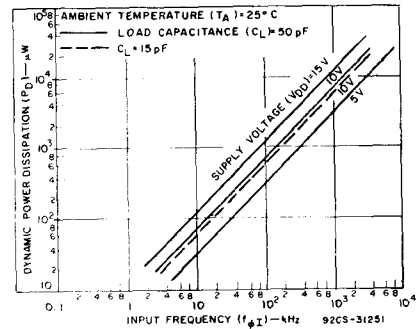

Fig. 10 — Typical dynamic power dissipation as a function of input frequency.

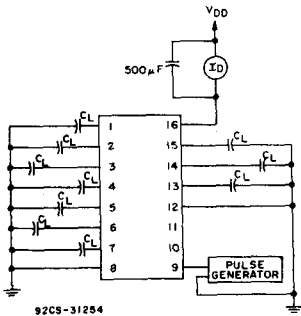

Fig. 11 — Dynamic power dissipation test circuit.

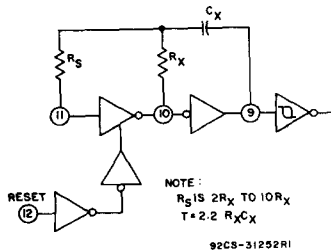

Fig. 12 — Typical RC circuit.

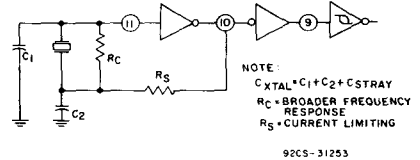

Fig. 13 — Typical crystal circuit.

# CD4060B Types

DYNAMIC ELECTRICAL CHARACTERISTICS at  $T_A = 25^\circ\text{C}$ , Input  $t_r, t_f = 20$  ns,  
 $C_L = 50$  pF,  $R_L = 200$  k $\Omega$  [cont'd]

CHARACTERISTIC	TEST CONDITIONS	VDD (V)	LIMITS			UNITS	
			Min.	Typ.	Max.		
<b>RC Operation</b>							
Variation of Frequency (Unit-to-Unit)	$C_X = 200$ pF, $R_S = 560$ k $\Omega$ , $R_X = 50$ k $\Omega$	5	18	21.5	25	kHz	
		10	20	23	26		
		15	21.1	24	27		
Variation of Frequency with voltage change (Same Unit)	$C_X = 200$ pF, $R_S = 560$ k $\Omega$ , $R_X = 50$ k $\Omega$	5V to 10 V 10V to 15V	—	—	2 1		
R <sub>X</sub> max.	$C_X = 10$ $\mu$ F $= 50$ $\mu$ F $= 10$ $\mu$ F	5	—	—	20	M $\Omega$	
		10	—	—	20		
		15	—	—	10		
C <sub>X</sub> max.	$R_X = 500$ k $\Omega$ $= 300$ k $\Omega$ $= 300$ k $\Omega$	5	—	—	1000	$\mu$ F	
		10	—	—	50		
		15	—	—	50		
Maximum Oscillator Frequency*	$R_X = 5$ k $\Omega$ $C_X = 15$ pF	10	530	650	810	kHz	
		15	690	800	940		
Drive Current at Pin 9 (For Oscillator Design)	I <sub>OL</sub>	$V_O = 0.4$ V	5	0.16	0.35	—	mA
		$= 0.5$ V	10	0.42	0.8	—	
		$= 1.5$ V	15	1	2	—	
	I <sub>OH</sub>	$V_O = 4.6$ V	5	-0.16	-0.35	—	
		$= 9.5$ V	10	-0.42	-0.8	—	
		$= 13.5$ V	15	-1	-2	—	

\*RC oscillator applications are not recommended at supply voltages below 7 V for  $R_X < 50$  k $\Omega$ .

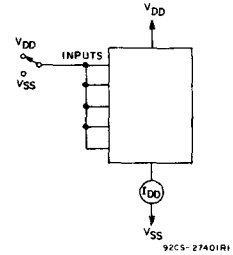

Fig. 14 - Quiescent device current.

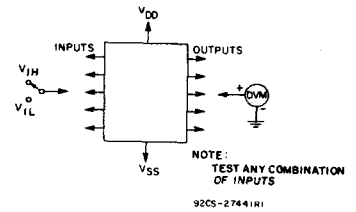

Fig. 15 - Input voltage.

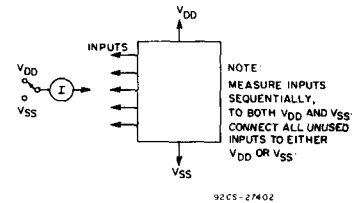
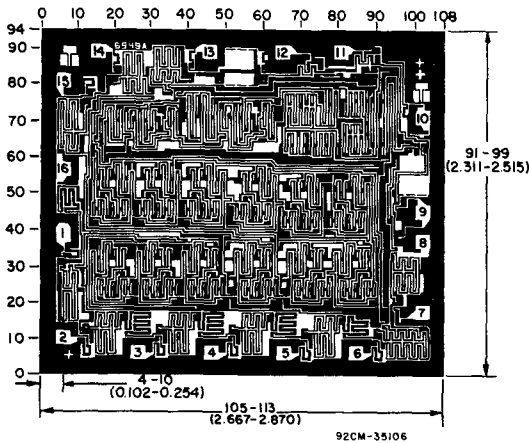
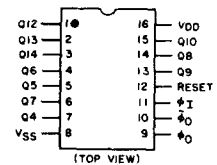

Fig. 16 - Input current.



Dimensions and pad layout for CD4060B.

## TERMINAL DIAGRAM



92CS-2376R2

Dimensions in parentheses are in millimeters and are derived from the basic inch dimensions as indicated. Grid graduations are in mils (10<sup>-3</sup> inch).

The photographs and dimensions of each CMOS chip represent a chip when it is part of the wafer. When the wafer is separated into individual chips, the angle of cleavage may vary with respect to the chip face for different chips. The actual dimensions of the isolated chip, therefore, may differ slightly from the nominal dimensions shown. The user should consider a tolerance of  $-3$  mils to  $+16$  mils applicable to the nominal dimensions shown.

# CD4063B Types

## CMOS 4-Bit Magnitude Comparator

High Voltage Types (20-Volt Rating)

The RCA-CD4063B is a 4-bit magnitude comparator designed for use in computer and logic applications that require the comparison of two 4-bit words. This logic circuit determines whether one 4-bit word (Binary or BCD) is "less than", "equal to", or "greater than" a second 4-bit word.

The CD4063B has eight comparing inputs (A3, B3, through A0, B0), three outputs (A < B, A = B, A > B) and three cascading inputs (A < B, A = B, A > B) that permit systems designers to expand the comparator function to 8, 12, 16 . . . 4N bits. When a single CD4063B is used, the cascading inputs are connected as follows: (A < B) = low, (A = B) = high, (A > B) = low.

For words longer than 4 bits, CD4063B devices may be cascaded by connecting the outputs of the less-significant comparator to the corresponding cascading inputs of the more-significant comparator. Cascading inputs (A < B, A = B, and A > B) on the least significant comparator are connected to a low, a high, and a low level, respectively.

The CD4063B types are supplied in 16-lead hermetic dual-in-line ceramic packages (D and F suffixes), 16-lead dual-in-line plastic package (E suffix), 16-lead ceramic flat package (K suffix), and in chip form (H suffix). This device is pin-compatible with the standard 7485 TTL type.

### Features:

- Expansion to 8, 12, 16...4N bits by cascading units
- Medium-speed operation:
  - compares two 4-bit words in 250 ns (typ.) at 10 V
- 100% tested for quiescent current at 20 V
- Standardized symmetrical output characteristics
- 5-V, 10-V, and 15-V parametric ratings
- Maximum input current of 1  $\mu$ A at 18 V over full package temperature range; 100 nA at 18 V and 25°C
- Noise margin (full package temperature range) = 1 V at  $V_{DD} = 5$  V  
2 V at  $V_{DD} = 10$  V  
2.5 V at  $V_{DD} = 15$  V
- Meets all requirements of JEDEC Tentative Standard No. 13A, "Standard Specifications for Description of 'B' Series CMOS Devices"

### Applications:

- Servo motor controls
- Process controllers

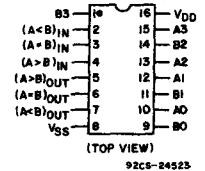
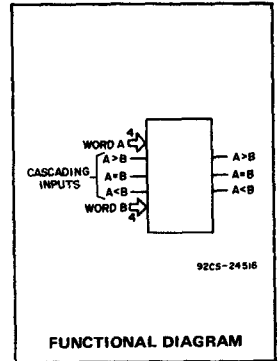

### MAXIMUM RATINGS, Absolute-Maximum Values:

DC SUPPLY-VOLTAGE RANGE, ( $V_{DD}$ ) (Voltages referenced to $V_{SS}$ Terminal)	-0.5 to +20 V
INPUT VOLTAGE RANGE, ALL INPUTS	-0.5 to $V_{DD} + 0.5$ V
DC INPUT CURRENT, ANY ONE INPUT	$\pm 10$ mA
POWER DISSIPATION PER PACKAGE ( $P_D$ ):	
For $T_A = -40$ to $+60^\circ\text{C}$ (PACKAGE TYPE E)	500 mW
For $T_A = +60$ to $+85^\circ\text{C}$ (PACKAGE TYPE E)	Derate Linearly at 12 mW/ $^\circ\text{C}$ to 200 mW
For $T_A = -55$ to $+100^\circ\text{C}$ (PACKAGE TYPES D, F, K)	500 mW
For $T_A = +100$ to $+125^\circ\text{C}$ (PACKAGE TYPES D, F, K)	Derate Linearly at 12 mW/ $^\circ\text{C}$ to 200 mW
DEVICE DISSIPATION PER OUTPUT TRANSISTOR FOR $T_A =$ FULL PACKAGE-TEMPERATURE RANGE (All Package Types)	100 mW
OPERATING-TEMPERATURE RANGE ( $T_A$ ):	
PACKAGE TYPES D, F, K, H	-55 to $+125^\circ\text{C}$
PACKAGE TYPE E	-40 to $+85^\circ\text{C}$
STORAGE TEMPERATURE RANGE ( $T_{stg}$ )	-65 to $+150^\circ\text{C}$
LEAD TEMPERATURE (DURING SOLDERING):	
At distance $1/16 \pm 1/32$ inch (1.59 $\pm$ 0.79 mm) from case for 10 s max.	$+265^\circ\text{C}$

### RECOMMENDED OPERATING CONDITIONS

For maximum reliability, nominal operating conditions should be selected so that operation is always within the following ranges:

CHARACTERISTIC	LIMITS		UNITS
	Min.	Max.	
Supply-Voltage Range (For $T_A$ =Full Package-Temperature Range)	3	18	V

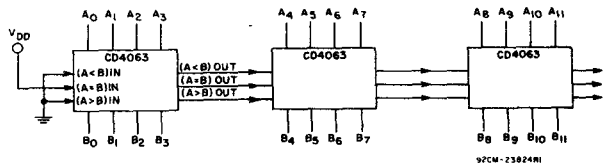

$$t_p \text{ TOTAL} = t_p \text{ (COMPARE)} + 2 \times t_p \text{ (CASCADE)}, \text{ AT } V_{DD} = 10\text{V}$$

(3 STAGES)

$$= 250 \times (2 \times 200) = 650 \text{ ns (TYP.)}$$

Fig. 1 - Typical speed characteristics of a 12-bit comparator.



# CD4063B Types

## STATIC ELECTRICAL CHARACTERISTICS

CHARACTER- ISTIC	CONDITIONS			LIMITS AT INDICATED TEMPERATURES (°C)							UNITS
	V <sub>O</sub> (V)	V <sub>IN</sub> (V)	V <sub>DD</sub> (V)	Values at -55, +25, +125 Apply to D, F, K, H Packages				Values at -40, +25, +85 Apply to E Package			
				-55	-40	+85	+125	+25			
				Min.	Typ.	Max.					
Quiescent Device Current, I <sub>DD</sub> Max.	-	0,5	5	5	5	150	150	-	0.04	5	μA
	-	0,10	10	10	10	300	300	-	0.04	10	
	-	0,15	15	20	20	600	600	-	0.04	20	
	-	0,20	20	100	100	3000	3000	-	0.08	100	
Output Low (Sink) Current I <sub>OL</sub> Min.	0.4	0,5	5	0.64	0.61	0.42	0.36	0.51	1	-	mA
	0.5	0,10	10	1.6	1.5	1.1	0.9	1.3	2.6	-	
	1.5	0,15	15	4.2	4	2.8	2.4	3.4	6.8	-	
Output High (Source) Current, I <sub>OH</sub> Min.	4.6	0,5	5	-0.64	-0.61	-0.42	-0.36	-0.51	-1	-	mA
	2.5	0,5	5	-2	-1.8	-1.3	-1.15	-1.6	-3.2	-	
	9.5	0,10	10	-1.6	-1.5	-1.1	-0.9	-1.3	-2.6	-	
	13.5	0,15	15	-4.2	-4	-2.8	-2.4	-3.4	-6.8	-	
Output Voltage: Low-Level, V <sub>OL</sub> Max.	-	0,5	5	0.05			-	0	0.05	-	V
	-	0,10	10	0.05			-	0	0.05	-	
	-	0,15	15	0.05			-	0	0.05	-	
Output Voltage: High-Level, V <sub>OH</sub> Min.	-	0,5	5	4.95			4.95	5	-	-	V
	-	0,10	10	9.95			9.95	10	-	-	
	-	0,15	15	14.95			14.95	15	-	-	
Input Low Voltage, V <sub>IL</sub> Max.	0.5, 4.5	-	5	1.5			-	-	1.5	-	V
	1, 9	-	10	3			-	-	3	-	
	1.5, 13.5	-	15	4			-	-	4	-	
Input High Voltage, V <sub>IH</sub> Min.	0.5, 4.5	-	5	3.5			3.5	-	-	-	V
	1, 9	-	10	7			7	-	-	-	
	1.5, 13.5	-	15	11			11	-	-	-	
Input Current I <sub>IN</sub> Max.	-	0,18	18	±0.1	±0.1	±1	±1	-	±10 <sup>-5</sup>	±0.1	μA

## TRUTH TABLE

INPUTS							OUTPUTS		
COMPARING				CASCADING					
A3, B3	A2, B2	A1, B1	A0, B0	A < B	A = B	A > B	A < B	A = B	A > B
A3 > B3	X	X	X	X	X	X	0	0	1
A3 = B3	A2 > B2	X	X	X	X	X	0	0	1
A3 = B3	A2 = B2	A1 > B1	X	X	X	X	0	0	1
A3 = B3	A2 = B2	A1 = B1	A0 > B0	X	X	X	0	0	1
A3 = B3	A2 = B2	A1 = B1	A0 = B0	0	0	1	0	0	1
A3 = B3	A2 = B2	A1 = B1	A0 = B0	0	1	0	0	1	0
A3 = B3	A2 = B2	A1 = B1	A0 = B0	1	0	0	1	0	0
A3 = B3	A2 = B2	A1 = B1	A0 < B0	X	X	X	1	0	0
A3 = B3	A2 = B2	A1 < B1	X	X	X	X	1	0	0
A3 = B3	A2 < B2	X	X	X	X	X	1	0	0
A3 < B3	X	X	X	X	X	X	1	0	0

X = Don't Care

Logic 1 ≡ High Level

Logic 0 ≡ Low Level

# CD4063B Types

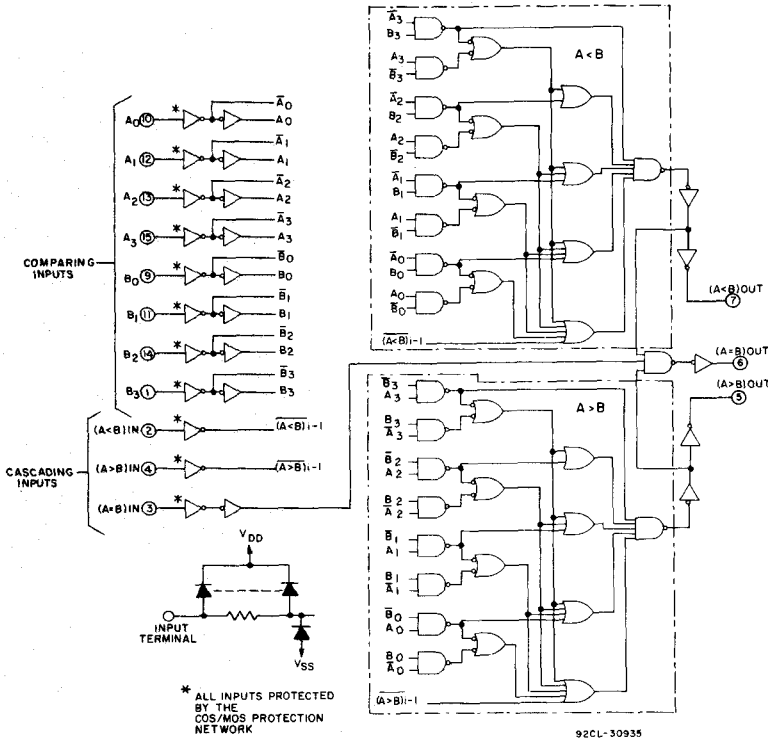

Fig. 2 - Logic diagram for CD4063B.

## DYNAMIC ELECTRICAL CHARACTERISTICS

At  $T_A = 25^\circ\text{C}$ ; Input  $t_r, t_f = 20\text{ ns}$ ,  $C_L = 50\text{ pF}$ ,  $R_L = 200\text{ k}\Omega$

CHARACTERISTIC	TEST CONDITIONS	ALL TYPES LIMITS		UNITS	
		V <sub>DD</sub> Volts	Typ.		Max.
Propagation Delay Time: Comparing Inputs to Outputs, $t_{PHL}$ , $t_{PLH}$		5	625	1250	ns
		10	250	500	
		15	175	350	
Cascading Inputs to Outputs, $t_{PHL}$ , $t_{PLH}$		5	500	1000	ns
		10	200	400	
		15	140	280	
Transition Time, $t_{THL}$ , $t_{TLH}$		5	100	200	ns
		10	50	100	
		15	40	80	
Input Capacitance, $C_{iN}$	Any Input		5	7.5	pF

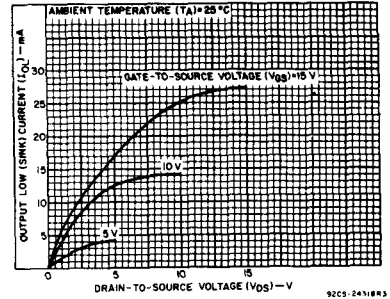

Fig. 3 - Typical output low (sink) current characteristics.

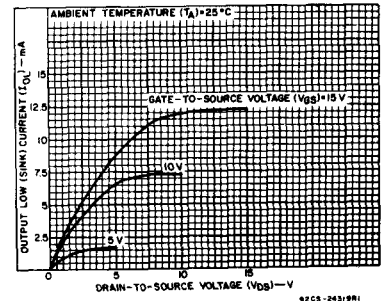

Fig. 4 - Minimum output low (sink) current characteristics.

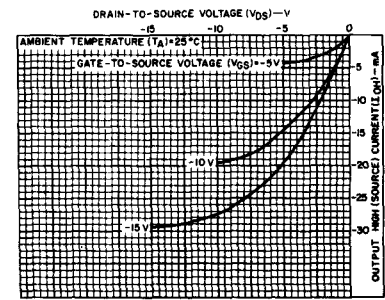

Fig. 5 - Typical output high (source) current characteristics.

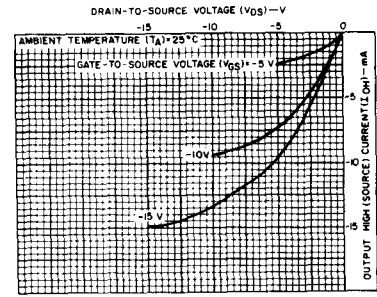

Fig. 6 - Minimum output high (source) current characteristics.

# CD4063B Types

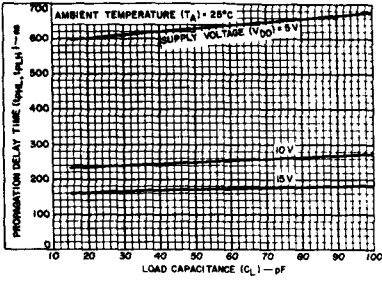

Fig. 7 - Typical propagation delay time vs. load capacitance ("comparing inputs" to outputs).

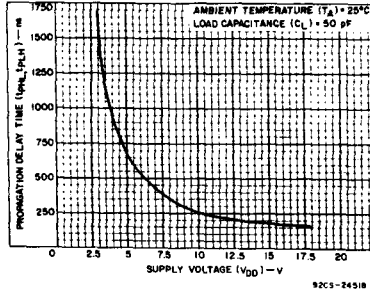

Fig. 8 - Typical propagation delay time vs. supply voltage ("comparing inputs" to outputs).

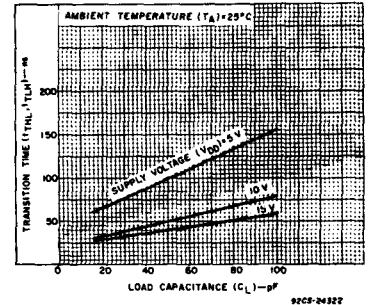

Fig. 9 - Typical transition time vs. load capacitance.

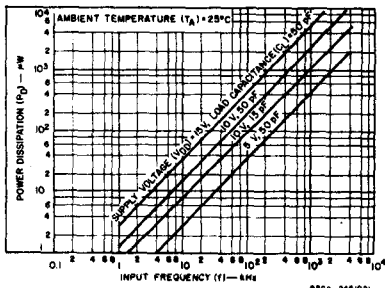

Fig. 10 - Typical power dissipation vs. frequency (see Fig. 12 - dynamic power dissipation test circuit).

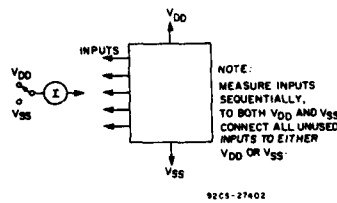

Fig. 11 - Input current test circuit.

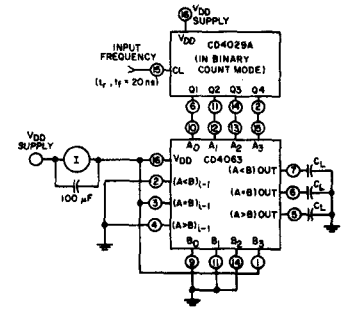

Fig. 12 - Dynamic power dissipation test circuit.

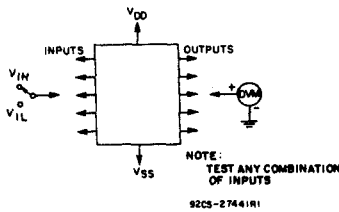

Fig. 13 - Input-voltage test circuit.

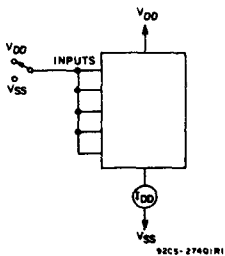
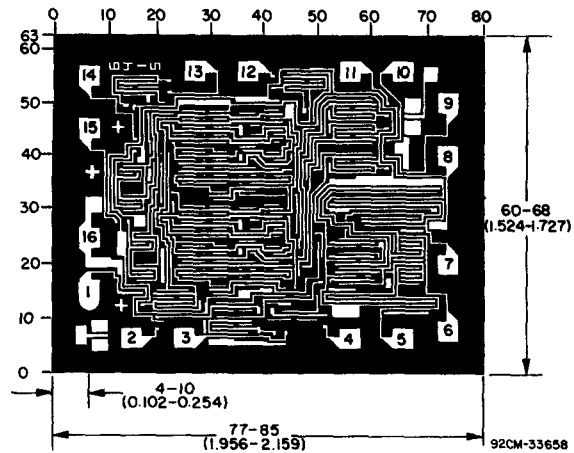

Fig. 14 - Quiescent-device-current test circuit.



Dimensions in parentheses are in millimeters and are derived from the basic inch dimensions as indicated. Grid graduations are in mils ( $10^{-3}$  inch).

The photographs and dimensions of each CMOS chip represent a chip when it is part of the wafer. When the wafer is separated into individual chips, the angle of cleavage may vary with respect to the chip face for different chips. The actual dimensions of the isolated chip, therefore, may differ slightly from the nominal dimensions shown. The user should consider a tolerance of  $-3$  mils to  $+16$  mils applicable to the nominal dimensions shown.

# CD4066B Types

## CMOS Quad Bilateral Switch

For Transmission or Multiplexing of Analog or Digital Signals

### High-Voltage Types (20-Volt Rating)

The RCA-CD4066B is a quad bilateral switch intended for the transmission or multiplexing of analog or digital signals. It is pin-for-pin compatible with RCA-CD4016B, but exhibits a much lower on-state resistance. In addition, the on-state resistance is relatively constant over the full input-signal range.

The CD4066B consists of four independent bilateral switches. A single control signal is required per switch. Both the p and the n device in a given switch are biased on or off simultaneously by the control signal. As shown in Fig. 1, the well of the n-channel device on each switch is either tied to the input when the switch is on or to  $V_{SS}$  when the switch is off. This configuration eliminates the variation of the switch-transistor threshold voltage with input signal, and thus keeps the on-state resistance low over the full operating-signal range.

The advantages over single-channel switches include peak input-signal voltage swings equal to the full supply voltage, and more constant on-state impedance over the input-signal range. For sample-and-hold applications, however, the CD4016B is recommended.

The CD4066B is available in 14-lead ceramic dual-in-line packages (D and F suffixes), 14-lead plastic dual-in-line packages (E suffix), 14-lead ceramic flat packages (K suffix), and in chip form (H suffix).

### MAXIMUM RATINGS, Absolute-Maximum Values:

DC SUPPLY-VOLTAGE RANGE, ( $V_{DD}$ ) (Voltages referenced to $V_{SS}$ Terminal)	-0.5 to +20 V
INPUT VOLTAGE RANGE, ALL INPUTS	-0.5 to $V_{DD} + 0.5$ V
DC INPUT CURRENT, ANY ONE INPUT (except for TRANSMISSION GATE which is 25 mA)	$\pm 10$ mA
POWER DISSIPATION PER PACKAGE ( $P_D$ ):	
For $T_A = -40$ to $+60^\circ\text{C}$ (PACKAGE TYPE E)	500 mW
For $T_A = +60$ to $+85^\circ\text{C}$ (PACKAGE TYPE E)	Derate Linearly at 12 mW/ $^\circ\text{C}$ to 200 mW
For $T_A = -55$ to $+100^\circ\text{C}$ (PACKAGE TYPES D, F, K)	500 mW
For $T_A = +100$ to $+125^\circ\text{C}$ (PACKAGE TYPES D, F, K)	Derate Linearly at 12 mW/ $^\circ\text{C}$ to 200 mW
DEVICE DISSIPATION PER OUTPUT TRANSISTOR	
FOR $T_A =$ FULL PACKAGE-TEMPERATURE RANGE (All Package Types)	100 mW
OPERATING-TEMPERATURE RANGE ( $T_A$ ):	
PACKAGE TYPES D, F, K, H	$-55$ to $+125^\circ\text{C}$
PACKAGE TYPE E	$-40$ to $+85^\circ\text{C}$
STORAGE TEMPERATURE RANGE ( $T_{stg}$ )	$-65$ to $+150^\circ\text{C}$
LEAD TEMPERATURE (DURING SOLDERING):	
At distance 1/16 $\pm$ 1/32 inch (1.59 $\pm$ 0.79 mm) from case for 10 s max.	$+265^\circ\text{C}$

### RECOMMENDED OPERATING CONDITIONS

For maximum reliability, nominal operating conditions should be selected so that operation is always within the following ranges:

CHARACTERISTIC	LIMITS		UNITS
	Min.	Max.	
Supply-Voltage Range (For $T_A =$ Full Package-Temperature Range)	3	18	V

### Features:

- 15-V digital or  $\pm 7.5$ -V peak-to-peak switching
- 125 $\Omega$  typical on-state resistance for 15-V operation
- Switch on-state resistance matched to within 5  $\Omega$  over 15-V signal-input range
- On-state resistance flat over full peak-to-peak signal range
- High on/off output-voltage ratio: 80 dB typ. @  $f_{is} = 10$  kHz,  $R_L = 1$  k $\Omega$
- High degree of linearity: <0.5% distortion typ. @  $f_{is} = 1$  kHz,  $V_{is} = 5$  Vp-p,  $V_{DD} - V_{SS} \geq 10$  V,  $R_L = 10$  k $\Omega$
- Extremely low off-state switch leakage resulting in very low offset current and high effective off-state resistance: 10 pA typ. @  $V_{DD} - V_{SS} = 10$  V,  $T_A = 25^\circ\text{C}$
- Extremely high control input impedance (control circuit isolated from signal circuit): 1012  $\Omega$  typ.
- Low crosstalk between switches: -50 dB typ. @  $f_{is} = 8$  MHz,  $R_L = 1$  k $\Omega$
- Matched control-input to signal-output capacitance: Reduces output signal transients
- Frequency response, switch on = 40 MHz (typ.)
- 100% tested for quiescent current at 20 V
- 5-V, 10-V, and 15-V parametric ratings
- Meets all requirements of JEDEC Tentative Standard No. 13A, "Standard Specifications for Description of "B" Series CMOS Devices"

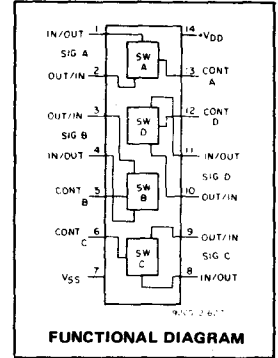

### Applications:

- Analog signal switching/multiplexing
- Signal gating
- Modulator
- Squelch control
- Demodulator
- Chopper
- Commutating switch
- Digital signal switching/Multiplexing
- Transmission-gate logic implementation
- Analog-to-digital & digital-to-analog conversion
- Digital control of frequency, impedance, phase, and analog-signal gain

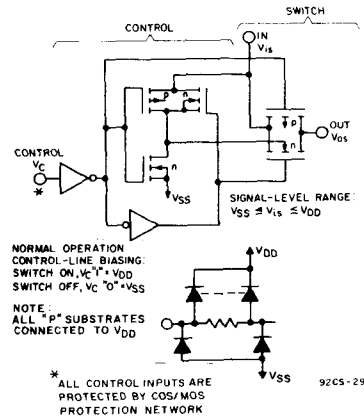

NORMAL OPERATION  
CONTROL-LINE BIASING:  
SWITCH ON,  $V_C = V_{DD}$   
SWITCH OFF,  $V_C = V_{SS}$

NOTE  
ALL "p+" SUBSTRATES  
CONNECTED TO  $V_{DD}$

\* ALL CONTROL INPUTS ARE  
PROTECTED BY COS/MOS  
PROTECTION NETWORK

92CS-29113

Fig. 1 - Schematic diagram of 1 of 4 identical switches and its associated control circuitry.

# CD4066B Types

## ELECTRICAL CHARACTERISTICS

Characteristic	Test Conditions	LIMITS AT INDICATED TEMPERATURES (°C)							UNITS	
		Values at -55, +25, +125 Apply to D, F, K, H Packages								
		Values at -40, +25, +85 Apply to E Package								
	$V_{IN}$ (V)	$V_{DD}$ (V)	-55	-40	+85	+125	Typ.	Max.		
Quiescent Device Current, $I_{DD}$		0.5	5	0.25	0.25	7.5	7.5	0.01	0.25	$\mu A$
		0.10	10	0.5	0.5	15	15	0.01	0.5	
		0.15	15	1	1	30	30	0.01	1	
		0.20	20	5	5	150	150	0.02	5	
<b>Signal Inputs (<math>V_{is}</math>) and Output (<math>V_{os}</math>)</b>										
On-State Resistance, $r_{on}$ Max.	$V_C = V_{DD}$ $R_L = 10\text{ k}\Omega$ returned to $\frac{V_{DD} - V_{SS}}{2}$ $V_{is} = V_{SS}$ to $V_{DD}$	5	800	850	1200	1300	470	1050	$\Omega$	
		10	310	330	500	550	180	400		
		15	200	210	300	320	125	240		
$\Delta$ On-State Resistance Between Any 2 Switches, $\Delta r_{on}$	$R_L = 10\text{ k}\Omega$ , $V_C = V_{DD}$	5	-	-	-	-	15	-	$\Omega$	
		10	-	-	-	-	10	-		
		15	-	-	-	-	5	-		
Total Harmonic Distortion, THD	$V_C = V_{DD} = 5\text{ V}$ , $V_{SS} = -5\text{ V}$ , $V_{is(p-p)} = 5\text{ V}$ (Sine wave centered on 0V) $R_L = 10\text{ k}\Omega$ , $f_{is} = 1\text{ kHz}$ sine wave	-	-	-	-	-	0.4	-	%	
-3dB Cutoff Frequency (Switch on)	$V_C = V_{DD} = 5\text{ V}$ , $V_{SS} = -5\text{ V}$ , $V_{is(p-p)} = 5\text{ V}$ (Sine wave centered on 0V) $R_L = 1\text{ k}\Omega$	-	-	-	-	-	40	-	MHz	
-50dB Feed-through Frequency (Switch off)	$V_C = V_{SS} = -5\text{ V}$ , $V_{is(p-p)} = 5\text{ V}$ Sine wave centered on 0V $R_L = 1\text{ k}\Omega$	-	-	-	-	-	1	-	MHz	
Input/Output Leakage Current (Switch off) $I_{is}$ Max.	$V_C = 0\text{ V}$ $V_{is} = 18\text{ V}$ ; $V_{os} = 0\text{ V}$ , $V_{is} = 0\text{ V}$ ; $V_{os} = 18\text{ V}$	18	$\pm 0.1$	$\pm 0.1$	$\pm 1$	$\pm 1$	$\pm 10^5$	$\pm 0.1$	$\mu A$	
-50 dB Crosstalk Frequency	$V_C(A) = V_{DD} = +5\text{ V}$ , $V_C(B) = V_{SS} = -5\text{ V}$ , $V_{is}(A) = 5\text{ V p-p}$ , $50\Omega$ source $R_L = 1\text{ k}\Omega$	-	-	-	-	-	8	-	MHz	
Propagation Delay (Signal Input to Signal Output) $t_{pd}$	$R_L = 200\text{ k}\Omega$ $V_C = V_{DD}$ , $V_{SS} = GND$ , $C_L = 50\text{ pF}$ $V_{is} = 10\text{ V}$ (Square wave centered on 5V) $t_r, t_f = 20\text{ ns}$	5	-	-	-	-	20	40	ns	
		10	-	-	-	-	10	20		
		15	-	-	-	-	7	15		
Capacitance: Input, $C_{is}$	$V_{DD} = +5\text{ V}$	-	-	-	-	-	8	-	pF	
Output, $C_{os}$	$V_C = V_{SS} = -5\text{ V}$	-	-	-	-	-	8	-		
Feedthrough, $C_{ios}$		-	-	-	-	-	0.5	-		

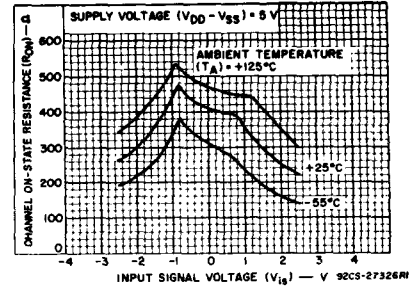

Fig. 2— Typical on-state resistance vs. input signal voltage (all types).

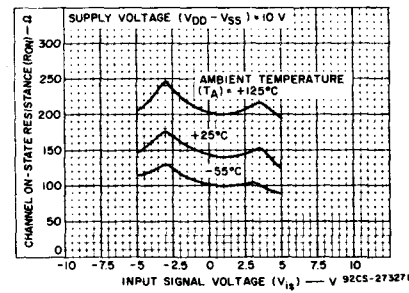

Fig. 3— Typical on-state vs. input signal voltage (all types).

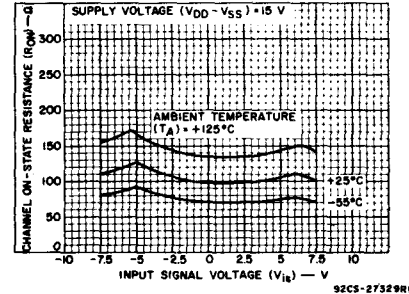

Fig. 4— Typical on-state resistance vs. input signal voltage (all types).

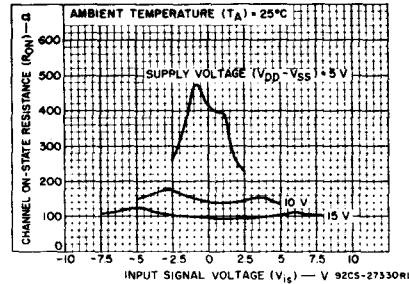

Fig. 5— on-state resistance vs. input signal voltage (all types).

# CD4066B Types

## ELECTRICAL CHARACTERISTICS (cont'd)

Characteristic	Test Conditions	LIMITS AT INDICATED TEMPERATURES (°C)							UNITS
		Values at -55, +25, +125 Apply to D, F, K, H, Packages Values at -40, +25, +85 Apply to E Package							
		V <sub>DD</sub> (V)	-55	-40	+85	+125	+25	Max.	
<b>Control (V<sub>C</sub>)</b>									
Control Input Low Voltage, V <sub>ILC</sub> Max.	I <sub>is</sub>   < 10 μA V <sub>is</sub> = V <sub>SS</sub> , V <sub>OS</sub> = V <sub>DD</sub> and V <sub>is</sub> = V <sub>DD</sub> , V <sub>OS</sub> = V <sub>SS</sub>	5	1	1	1	1	-	1	V
		10	2	2	2	2	-	2	
		15	2	2	2	2	-	2	
Control Input High Voltage, V <sub>IHC</sub>	See Fig. 6	5	3.5 (Min.)					V	
		10	7 (Min.)						
		15	11 (Min.)						
Input Current, I <sub>IN</sub> Max.	V <sub>is</sub> ≤ V <sub>DD</sub> V <sub>DD</sub> - V <sub>SS</sub> = 18 V V <sub>CC</sub> ≤ V <sub>DD</sub> - V <sub>SS</sub>	18	±0.1	±0.1	±1	±1	±10-5	±0.1	μA
Crosstalk (Control Input to Signal Output)	V <sub>C</sub> = 10 V (Sq. Wave) t <sub>r</sub> , t <sub>f</sub> = 20 ns R <sub>L</sub> = 10 kΩ	10	-	-	-	-	50	-	mV
Turn-On and Turn-Off Propagation Delay	V <sub>IN</sub> = V <sub>DD</sub> t <sub>r</sub> , t <sub>f</sub> = 20 ns C <sub>L</sub> = 50 pF R <sub>L</sub> = 1 kΩ	5	-	-	-	-	35	70	ns
		10	-	-	-	-	20	40	
		15	-	-	-	-	15	30	
Maximum Control Input Repetition Rate	V <sub>is</sub> = V <sub>DD</sub> , V <sub>SS</sub> = GND, R <sub>L</sub> = 1 kΩ to gnd, C <sub>L</sub> = 50 pF, V <sub>C</sub> = 10 V (Square wave centered on 5 V) t <sub>r</sub> , t <sub>f</sub> = 20 ns, V <sub>os</sub> = ½ V <sub>OS</sub> @ 1 kHz	5	-	-	-	-	6	-	MHz
		10	-	-	-	-	9	-	
		15	-	-	-	-	9.5	-	
Input Capacitance, C <sub>IN</sub>							5	7.5	μF

V <sub>DD</sub> (V)	V <sub>is</sub> (V)	Switch Input					Switch Output, V <sub>OS</sub> (V)	
		I <sub>is</sub> (mA)					Min.	Max.
		-55°C	-40°C	+25°C	+85°C	+125°C		
5	0	0.64	0.61	0.51	0.42	0.36	-	0.4
5	5	-0.64	-0.61	-0.51	-0.42	-0.36	4.6	-
10	0	1.6	1.5	1.3	1.1	0.9	-	0.5
10	10	-1.6	-1.5	-1.3	-1.1	-0.9	9.5	-
15	0	4.2	4	3.4	2.8	2.4	-	1.5
15	15	-4.2	-4	-3.4	-2.8	-2.4	13.5	-

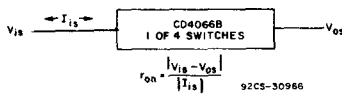

Fig. 6—Determination of  $r_{on}$  as a test condition for control input high voltage ( $V_{IHC}$ ) specification.

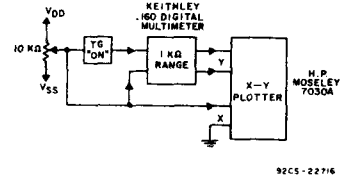

Fig. 7—Channel on-state resistance measurement circuit.

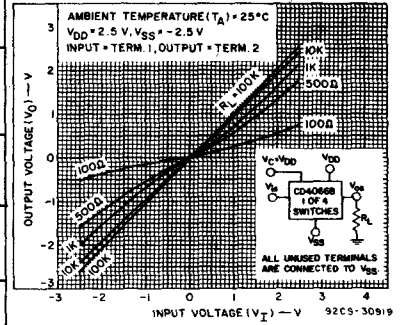

Fig. 8—Typical ON characteristics for 1 of 4 Channels.

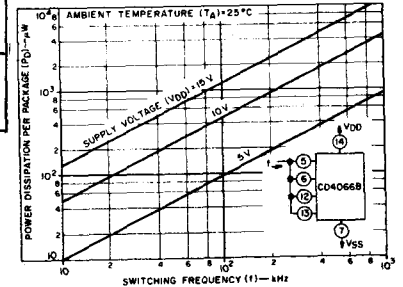

Fig. 9—Power dissipation per package vs. switching frequency.

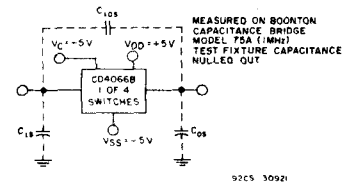

Fig. 10—Capacitance test circuit.

# CD4066B Types

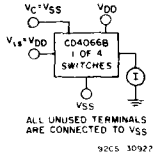

Fig. 11 - Off-switch input or output leakage.

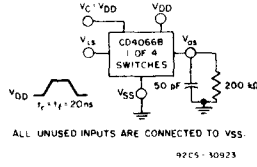

Fig. 12 - Propagation delay time signal input ( $V_{is}$ ) to signal output ( $V_{Os}$ ).

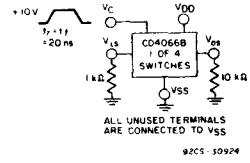

Fig. 13 - Crosstalk-control input to signal output.

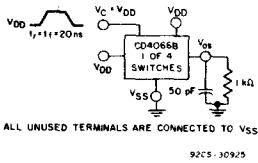

Fig. 14 - Propagation delay  $t_{PLH}$ ,  $t_{PHL}$  control-signal output. Delay is measured at  $V_{Os}$  level of +10% from ground (turn-on) or on-state output level (turn-off).

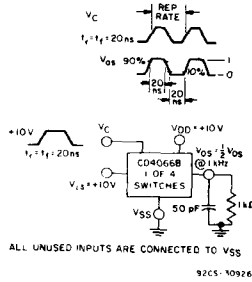

Fig. 15 - Maximum allowable control input repetition rate.

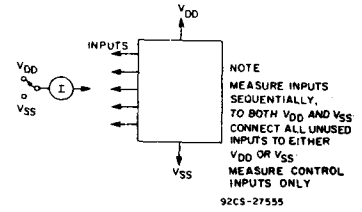

Fig. 16 - Input leakage current test circuit.

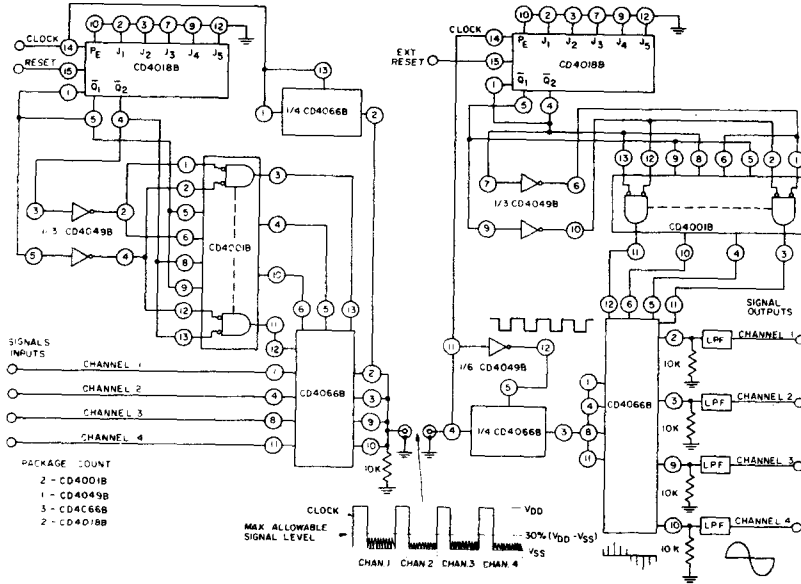

Fig. 17 - 4-channel PAM multiplex system diagram.

## CD4066B Types

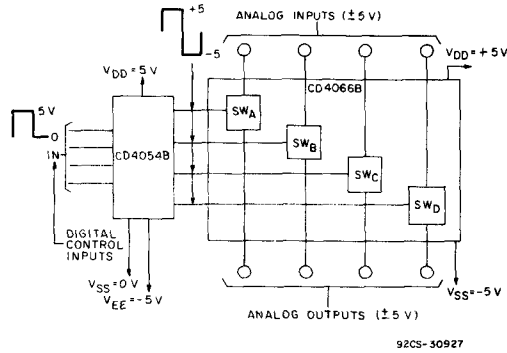
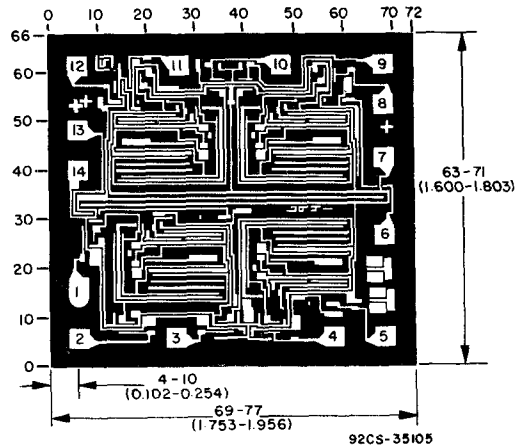

Fig. 18 — Bidirectional signal transmission via digital control logic.



### CD4066BH CHIP PHOTOGRAPH

Dimensions in parentheses are in millimeters and are derived from the basic inch dimensions as indicated. Grid graduations are in mils (10<sup>-3</sup> inch).

The photographs and dimensions of each CMOS chip represent a chip when it is part of the wafer. When the wafer is separated into individual chips, the angle of cleavage may vary with respect to the chip face for different chips. The actual dimensions of the isolated chip, therefore, may differ slightly from the nominal dimensions shown. The user should consider a tolerance of -3 mils to +16 mils applicable to the nominal dimensions shown.

#### SPECIAL CONSIDERATIONS — CD4066B

- In applications that employ separate power sources to drive  $V_{DD}$  and the signal inputs, the  $V_{DD}$  current capability should exceed  $V_{DD}/R_L$  ( $R_L$  = effective external load of the four CD4066B bilateral switches). This provision avoids any permanent current flow or clamp action on the  $V_{DD}$  supply when power is applied or removed from the CD4066B.
- In certain applications, the external load-resistor current may include both  $V_{DD}$  and signal-line components. To avoid drawing  $V_{DD}$  current when switch current flows into terminals 1, 4, 8, or 11, the voltage drop across the bidirectional switch must not exceed 0.8 volts (calculated from  $R_{ON}$  values shown).  
No  $V_{DD}$  current will flow through  $R_L$  if the switch current flows into terminals 2, 3, 9, or 10.



# CMOS Analog Multiplexers/Demultiplexers

High-Voltage Types (20-Volt Rating)

- CD4067B – Single 16-Channel Multiplexer/Demultiplexer
- CD4097B – Differential 8-Channel Multiplexer/Demultiplexer

The RCA-CD4067B and CD4097B CMOS analog multiplexers/demultiplexers\* are digitally controlled analog switches having low ON impedance, low OFF leakage current, and internal address decoding. In addition, the ON resistance is relatively constant over the full input-signal range.

The CD4067B is a 16-channel multiplexer with four binary control inputs, A, B, C, D, and an inhibit input, arranged so that any combination of the inputs selects one switch.

The CD4097B is a differential 8-channel multiplexer having three binary control inputs A, B, C, and an inhibit input. The inputs permit selection of one of eight pairs of switches.

A logic "1" present at the inhibit input turns all channels off.

The CD4067 and CD4097 are supplied in 24-lead dual-in-line welded-seal ceramic packages (D suffix), 24-lead dual-in-line frit-seal ceramic packages (F suffix), 24-lead dual-in-line plastic packages (E suffix), 24-lead ceramic flat packages (K suffix), and in chip form (H suffix).

**Features:**

- Low ON resistance: 125 Ω (typ.) over 15 V<sub>p-p</sub> signal-input range for V<sub>DD</sub>-V<sub>SS</sub>=15 V
- High OFF resistance: channel leakage of ±10 pA (typ.) @ V<sub>DD</sub>-V<sub>SS</sub>=10 V
- Matched switch characteristics: R<sub>ON</sub>=5 Ω (typ.) for V<sub>DD</sub>-V<sub>SS</sub>=15 V
- Very low quiescent power dissipation under all digital-control input and supply conditions: 0.2 μW (typ.) @ V<sub>DD</sub>-V<sub>SS</sub>=10 V
- Binary address decoding on chip
- 5-V, 10-V, and 15-V parametric ratings
- 100% tested for quiescent current at 20 V
- Standardized symmetrical output characteristics
- Maximum input current of 1 μA at 18 V over full package temperature range; 100 nA at 18 V and 25°C
- Meets all requirements of JEDEC Tentative Standard No. 13A, "Standard Specifications for Description of 'B' Series CMOS Devices"

**Applications:**

- Analog and digital multiplexing and demultiplexing
- A/D and D/A conversion
- Signal gating

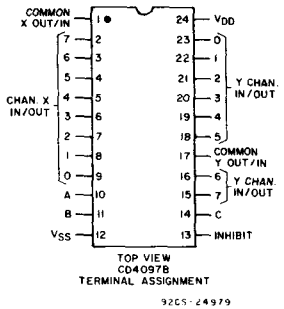
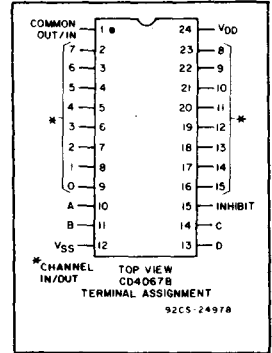

\*When these devices are used as demultiplexers, the channel in/out terminals are the outputs and the common out/in terminals are the inputs.

**Recommended Operating Conditions at T<sub>A</sub> = 25°C (Unless Otherwise Specified)**  
 For maximum reliability, nominal operating conditions should be selected so that operation is always within the following ranges. Values shown apply to all types except as noted.

Characteristic	Min.	Max.	Units
Supply-Voltage Range (T <sub>A</sub> =Full Package-Temp. Range)	3	18	V
Multiplexer Switch Input Current Capability	—	25	mA
Output Load Resistance	100	—	Ω

**NOTE:**  
 In certain applications, the external load-resistor current may include both V<sub>DD</sub> and signal-line components. To avoid drawing V<sub>DD</sub> current when switch current flows into the transmission gate inputs, the voltage drop across the bidirectional switch must not exceed 0.8 volt (calculated from R<sub>ON</sub> values shown in ELECTRICAL CHARACTERISTICS CHART). No V<sub>DD</sub> current will flow through R<sub>L</sub> if the switch current flows into terminal 1 on the CD4067; terminals 1 and 17 on the CD4097.

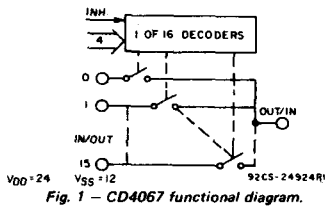

**CD4067 TRUTH TABLE**

A	B	C	D	Inh	Selected Channel
X	X	X	X	1	None
0	0	0	0	0	0
1	0	0	0	0	1
0	1	0	0	0	2
1	1	0	0	0	3
0	0	1	0	0	4
1	0	1	0	0	5
0	1	1	0	0	6
1	1	1	0	0	7
0	0	0	1	0	8
1	0	0	1	0	9
0	1	0	1	0	10
1	1	0	1	0	11
0	0	1	1	0	12
1	0	1	1	0	13
0	1	1	1	0	14
1	1	1	1	0	15

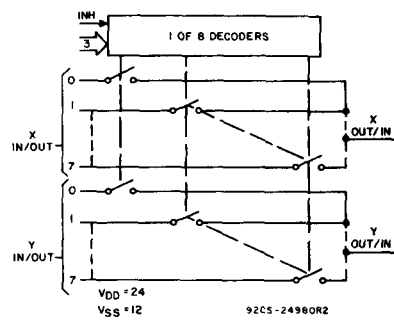



Fig. 2 - CD4097 functional diagram.

**CD4097 TRUTH TABLE**

A	B	C	Inh	Selected Channel
X	X	X	1	None
0	0	0	0	0X, 0Y
1	0	0	0	1X, 1Y
0	1	0	0	2X, 2Y
1	1	0	0	3X, 3Y
0	0	1	0	4X, 4Y
1	0	1	0	5X, 5Y
0	1	1	0	6X, 6Y
1	1	1	0	7X, 7Y

# CD4067B, CD4097B Types

## ELECTRICAL CHARACTERISTICS

CHARACTERISTIC	CONDITIONS			LIMITS at Indicated Temperature (°C)							Units
	V <sub>IS</sub> (V)	V <sub>SS</sub> (V)	V <sub>DD</sub> (V)	Values at -55, +25, +125 Apply to D, F, K, H pkg Values at -40, +25, +85, apply to E pkg							
				-55	-40	+85	+125	+25			
SIGNAL INPUTS (V <sub>IS</sub> ) AND OUTPUTS (V <sub>OS</sub> )											
Quiescent Device Current, I <sub>DD</sub> Max.			5	5	5	150	150	—	0.04	5	μA
			10	10	10	300	300	—	0.04	10	
			15	20	20	600	600	—	0.04	20	
ON-state Resistance V <sub>SS</sub> < V <sub>IS</sub> < V <sub>DD</sub> r <sub>on</sub> Max.		0	5	800	850	1200	1300	—	470	1050	Ω
		0	10	310	330	520	550	—	180	400	
		0	15	200	210	300	320	—	125	240	
Change in on-state Resistance (Between Any Two Channels) Δr <sub>on</sub>		0	5	—	—	—	—	—	15	—	Ω
		0	10	—	—	—	—	—	10	—	
		0	15	—	—	—	—	—	5	—	
OFF Channel Leakage Current: Any Channel OFF Max. or All Channels OFF (Common OUT/IN) Max.		0	18	±100*	±1000*	—	±0.1	±100*	—	nA	
Capacitance: Input, C <sub>IS</sub> Output, C <sub>OS</sub> CD4067 CD4097 Feed-through, C <sub>IOS</sub>		-5	5	—	—	—	—	5	—	pF	
				—	—	—	—	55	—		
				—	—	—	—	35	—		
Propagation Delay Time (Signal Input to Output)		V <sub>DD</sub>	R <sub>L</sub> = 200 KΩ	5	—	—	—	—	30	60	ns
			C <sub>L</sub> = 50 pF	10	—	—	—	—	15	30	
			t <sub>r</sub> , t <sub>f</sub> = 20 ns	15	—	—	—	—	10	20	
CONTROL (ADDRESS OR INHIBIT) V <sub>C</sub>											
Input Low Voltage, V <sub>IL</sub> Max.	= V <sub>DD</sub> thru 1 KΩ	R <sub>L</sub> = 1 KΩ to V <sub>SS</sub> I <sub>IS</sub> < 2 μA on all OFF Channels	5	1.5	—	—	1.5	V			
			10	3	—	—	3				
			15	4	—	—	4				
Input High Voltage, V <sub>IH</sub> Min.	= V <sub>DD</sub> thru 1 KΩ	R <sub>L</sub> = 1 KΩ to V <sub>SS</sub> I <sub>IS</sub> < 2 μA on all OFF Channels	5	3.5	3.5	—	—				
			10	7	7	—	—				
			15	11	11	—	—				

\* Determined by minimum feasible leakage measurement for automatic testing.

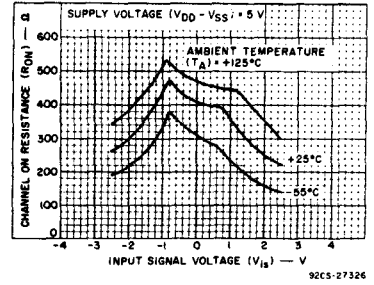

Fig. 3—Typical ON resistance vs. input signal voltage (all types).

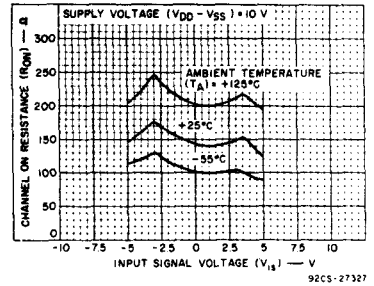

Fig. 4—Typical ON resistance vs. input signal voltage (all types).

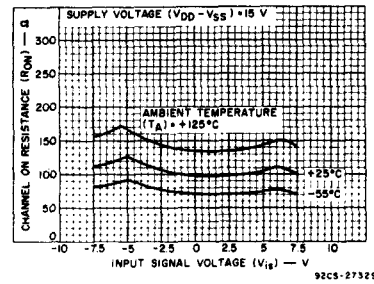

Fig. 5—Typical ON resistance vs. input signal voltage (all types).

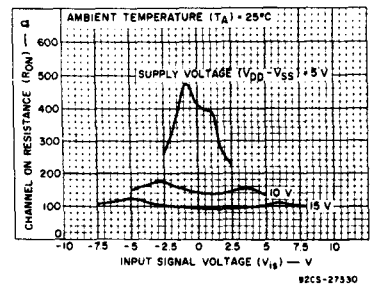

Fig. 6—Typical ON resistance vs. input signal voltage (all types).

# CD4067B, CD4097B Types

## ELECTRICAL CHARACTERISTICS (Cont'd)

CHARACTERISTIC	CONDITIONS			LIMITS at Indicated Temperature (°C)							Units
	V <sub>IS</sub> (V)	V <sub>SS</sub> (V)	V <sub>DD</sub> (V)	Values at -55, +25, +125 Apply to D, F, K, H, pkg. Values at -40, +25, +85, apply to E pkg				+25			
				-55	-40	+85	+125	Min.	Typ.	Max.	
Input Current, I <sub>IN</sub> Max.	V <sub>IN</sub> = 0, 18 V	18		±0.1	±0.1	±1	±1	-	±10 <sup>-5</sup>	±0.1	μA
Propagation Delay Time: Address or Inhibit-to-Signal OUT (Channel turning ON)	R <sub>L</sub> = 10 KΩ, C <sub>L</sub> = 50 pF, t <sub>r</sub> , t <sub>f</sub> = 20 ns	0	5	-	-	-	-	-	325	650	ns
		0	10	-	-	-	-	-	135	270	
		0	15	-	-	-	-	-	95	190	
Address or Inhibit-to-Signal OUT (Channel turning OFF)	R <sub>L</sub> = 300 Ω, C <sub>L</sub> = 50 pF, t <sub>r</sub> , t <sub>f</sub> = 20 ns	0	5	-	-	-	-	-	220	440	ns
		0	10	-	-	-	-	-	90	180	
		0	15	-	-	-	-	-	65	130	
Input Capacitance, C <sub>IN</sub>	Any Address or Inhibit Input			-	-	-	-	-	5	7.5	pF

## TEST CIRCUITS

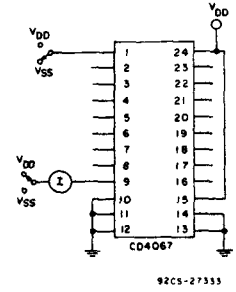

92CS-27333

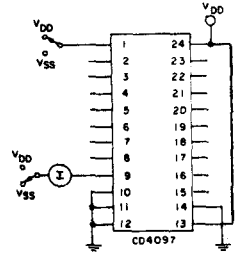

92CS-27332

Fig. 7—OFF channel leakage current—any channel OFF.

## MAXIMUM RATINGS, Absolute-Maximum Values:

- DC SUPPLY-VOLTAGE RANGE, (V<sub>DD</sub>) (Voltages referenced to V<sub>SS</sub> Terminal) . . . . . -0.5 to +20 V
- INPUT VOLTAGE RANGE, ALL INPUTS . . . . . -0.5 to V<sub>DD</sub> +0.5 V
- DC INPUT CURRENT, ANY ONE INPUT . . . . . ±10 mA
- POWER DISSIPATION PER PACKAGE (P<sub>D</sub>):
  - For T<sub>A</sub> = -40 to +60°C (PACKAGE TYPE E) . . . . . 500 mW
  - For T<sub>A</sub> = +60 to +85°C (PACKAGE TYPE E) . . . . . Derate Linearly at 12 mW/°C to 200 mW
  - For T<sub>A</sub> = -55 to +100°C (PACKAGE TYPES D, F, K) . . . . . 500 mW
  - For T<sub>A</sub> = +100 to +125°C (PACKAGE TYPES D, F, K) . . . . . Derate Linearly at 12 mW/°C to 200 mW
- DEVICE DISSIPATION PER OUTPUT TRANSISTOR
  - FOR T<sub>A</sub> = FULL PACKAGE-TEMPERATURE RANGE (All Package Types) . . . . . 100 mW
- OPERATING-TEMPERATURE RANGE (T<sub>A</sub>):
  - PACKAGE TYPES D, F, K, H . . . . . -55 to +125°C
  - PACKAGE TYPE E . . . . . -40 to +85°C
- STORAGE TEMPERATURE RANGE (T<sub>stg</sub>) . . . . . -65 to +150°C
- LEAD TEMPERATURE (DURING SOLDERING):
  - At distance 1/16 ± 1/32 inch (1.59 ± 0.79 mm) from case for 10 s max. . . . . +265°C

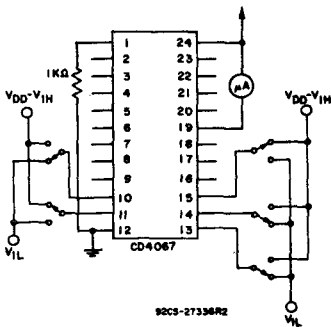

92CS-27336R2

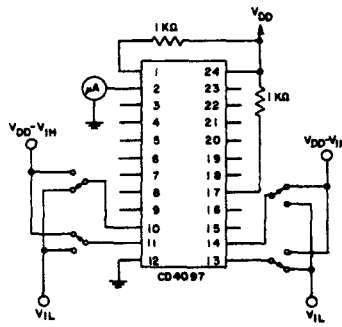

92CS-27337R2

Fig. 8—Input voltage—measure < 2 μA on all OFF channels (e.g., channel 12).

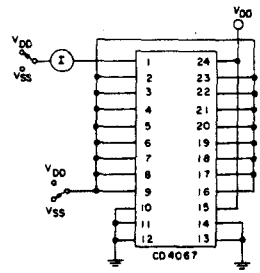

92CS-27334

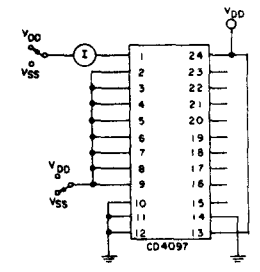

92CS-27335

Fig. 9—OFF channel leakage current—all channels OFF.

# CD4067B, CD4097B Types

## ELECTRICAL CHARACTERISTICS (Cont'd)

CHARACTERISTIC	TEST CONDITIONS			TYPICAL VALUES	UNITS	
	V <sub>is</sub> (V)	V <sub>DD</sub> (V)	R <sub>L</sub> (KΩ)			
Cutoff (-3-dB) Frequency Channel ON (Sine Wave Input)	5*	10	1	V <sub>OS</sub> at Common OUT/IN	MHz	
	20 log $\frac{V_{OS}}{V_{is}} = -3$ dB			CD4067: 14 CD4097: 20		
Total Harmonic Distortion, THD	2*	5	10	V <sub>OS</sub> at Any Channel	%	
	3*	10		0.3		
	5*	15		0.2		
f <sub>is</sub> = 1 kHz sine wave				0.12		
-40-dB Feedthrough Frequency (All Channels OFF)	5*	10	1	V <sub>OS</sub> at Common OUT/IN	MHz	
	20 log $\frac{V_{OS}}{V_{is}} = -40$ dB			CD4067: 20 CD4097: 12		
Signal Crosstalk (Frequency at -40 dB)	20 log $\frac{V_{OS}}{V_{is}} = -40$ dB			V <sub>OS</sub> at Any Channel	MHz	
				Between Any 2 Channels*		1
				Between Sections CD4097 Only		Measured on Common: 10 Measured on Any Channel: 18
Address-or-Inhibit-to-Signal Crosstalk	V <sub>SS</sub> =0, t <sub>r</sub> , t <sub>f</sub> =20 ns, V <sub>C</sub> =V <sub>DD</sub> -V <sub>SS</sub> (Square Wave)			75	mV (Peak)	

\* Peak-to-peak voltage symmetrical about  $\frac{V_{DD}-V_{SS}}{2}$

▲ Worst case.

\* Both ends of channel.

## TEST CIRCUITS (Cont'd)

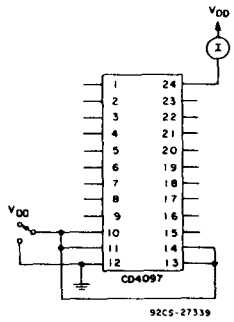
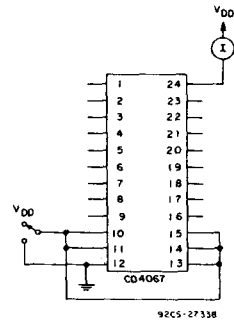

Fig. 10—Quiescent device current.

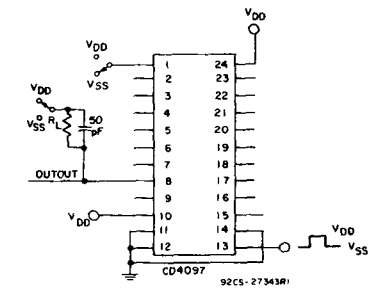
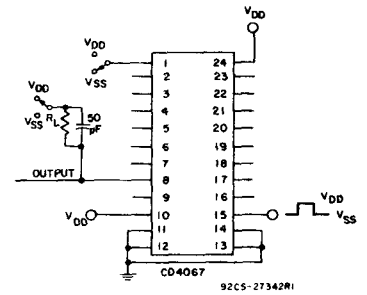

Fig. 12—Turn-on and turn-off propagation delay—inhibit input to signal output (e.g. measured on channel 1).

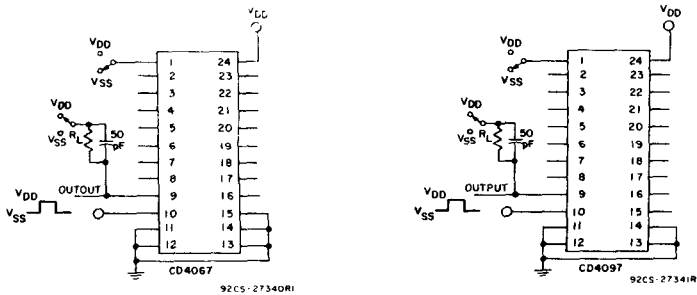

Fig. 11—Turn-on and turn-off propagation delay—address select input to signal output (e.g. measured on channel 0).

# CD4067B, CD4097B Types

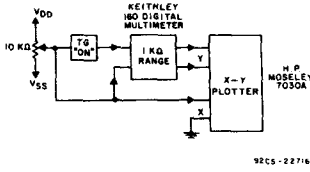

Fig. 13— Channel ON resistance measurement circuit.

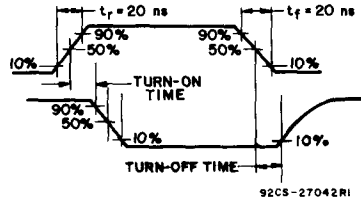

Fig. 14— Propagation delay waveform channel being turned ON ( $R_L = 10\text{ K}\Omega$ ,  $C_L = 50\text{ pF}$ ).

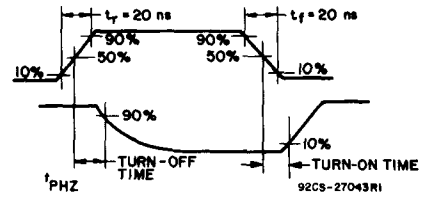

Fig. 15— Propagation delay waveform, channel being turned OFF ( $R_L = 300\Omega$ ,  $C_L = 50\text{ pF}$ ).

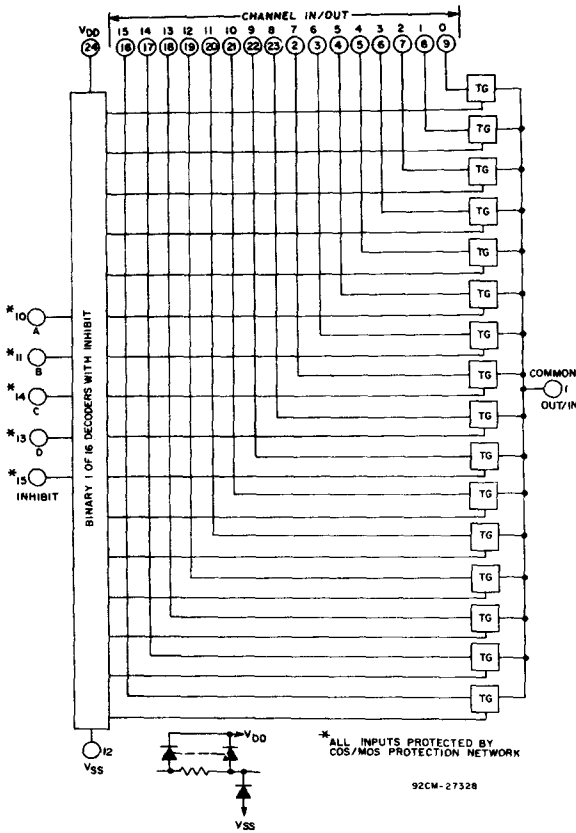

Fig. 16— CD4067 logic diagram.

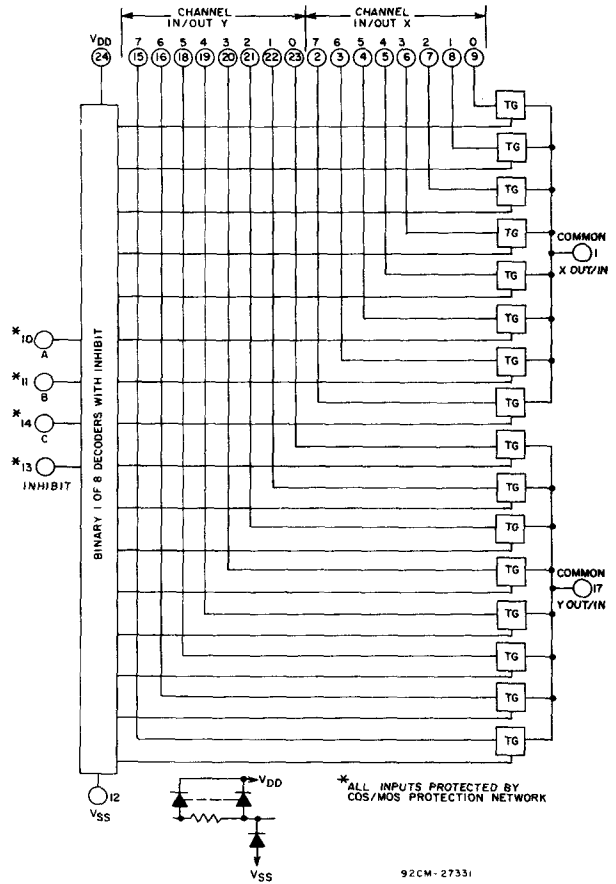

Fig. 17— CD4097 logic diagram.

## CD4067B, CD4097B Types

### SPECIAL CONSIDERATIONS

In applications where separate power sources are used to drive  $V_{DD}$  and the signal inputs, the  $V_{DD}$  current capability should exceed  $V_{DD}/R_L$  ( $R_L$ =effective external load). This provision avoids permanent current flow or clamping action on the  $V_{DD}$  supply when power is applied or removed from the CD4067B or CD4097B.

When switching from one address to another, some of the ON periods of the channels of the multiplexers will overlap momentarily, which may be objectionable in certain applications. Also when a channel is turned on or off by an address input, there is a momentary conductive path from the channel to  $V_{SS}$ , which will dump some charge from any capacitor connected to the input or output of the channel. The inhibit input turning on a channel will similarly dump some charge to  $V_{SS}$ .

The amount of charge dumped is mostly a function of the signal level above  $V_{SS}$ . Typically, at  $V_{DD}-V_{SS}=10$  V, a 100-pF

capacitor connected to the input or output of the channel will lose 3-4% of its voltage at the moment the channel turns on or off. This loss of voltage is essentially independent of the address or inhibit signal transition time, if the transition time is less than 1.2  $\mu$ s. When the inhibit signal turns a channel off, there is no charge dumping to  $V_{SS}$ . Rather, there is a slight rise in the channel voltage level (65 mV typ.) due to capacitive coupling from inhibit input to channel input or output. Address inputs also couple some voltage steps onto the channel signal levels.

In certain applications, the external load-resistor current may include both  $V_{DD}$  and signal-line components. To avoid drawing  $V_{DD}$  current when switch current flows into the transmission gate inputs, the voltage drop across the bidirectional switch must not exceed 0.8 volt (calculated from  $R_{ON}$  values shown in ELECTRICAL CHARACTERISTICS CHART). No  $V_{DD}$  current will flow through  $R_L$  if the switch current flows into terminal 1 on the CD4067B, terminals 1 and 17 on the CD4097B.

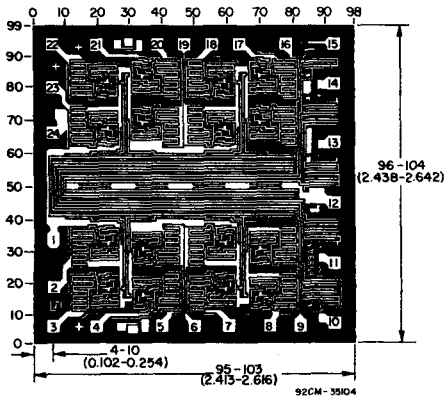

Dimensions and pad layout for CD4067BH.

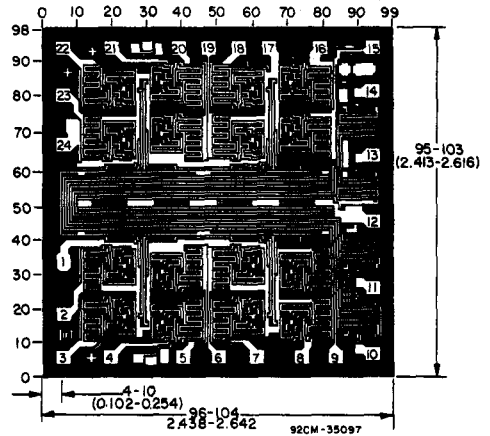

Dimensions and pad layout for CD4097BH.

Dimensions in parentheses are in millimeters and are derived from the basic inch dimensions as indicated. Grid graduations are in mils ( $10^{-3}$  inch).

The photographs and dimensions of each CMOS chip represent a chip when it is part of the wafer. When the wafer is separated into individual chips, the angle of cleavage may vary with respect to the chip face for different chips. The actual dimensions of the isolated chip, therefore, may differ slightly from the nominal dimensions shown. The user should consider a tolerance of  $-3$  mils to  $+16$  mils applicable to the nominal dimensions shown.

# CMOS 8-Input NAND/AND Gate

High-Voltage Types (20-Volt Rating)

The RCA-CD4068B NAND/AND gate provides the system designer with direct implementation of the positive-logic 8-input NAND and AND functions and supplements the existing family of CMOS gates.

The CD4068B types are supplied in 14-lead dual-in-line ceramic packages (D and F suffixes), 14-lead dual-in-line plastic packages (E suffix), 14-lead ceramic flat packages (K suffix), and in chip form (H suffix).

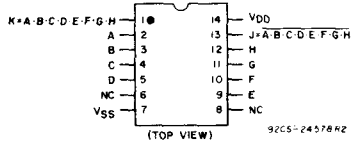

TERMINAL ASSIGNMENT

**Features:**

- Medium-Speed Operation:  $t_{PHL}$ ,  $t_{PLH} = 75$  ns (typ.) at  $V_{DD} = 10$  V
- Buffered inputs and outputs
- 5-V, 10-V, and 15-V parametric ratings
- Standardized symmetrical output characteristics
- 100% tested for quiescent current at 20 V
- Maximum input current of 1  $\mu$ A at 18 V over full package-temperature range; 100 nA at 18 V and 25°C
- Noise margin (over full package-temperature range): 1 V at  $V_{DD} = 5$  V, 2 V at  $V_{DD} = 10$  V, 2.5 V at  $V_{DD} = 15$  V
- Meets all requirements of JEDEC Tentative Standard No. 13A, "Standard Specifications for Description of 'B' Series CMOS Devices"

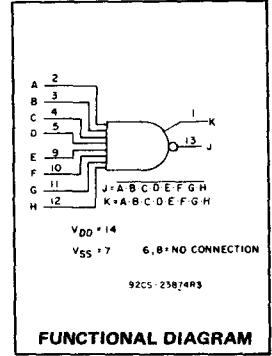

FUNCTIONAL DIAGRAM

**RECOMMENDED OPERATING CONDITIONS**

For maximum reliability, nominal operating conditions should be selected so that operation is always within the following ranges:

CHARACTERISTIC	Min.	Max.	Units
Supply-Voltage Range (For $T_A =$ Full Package Temperature Range)	3	18	V

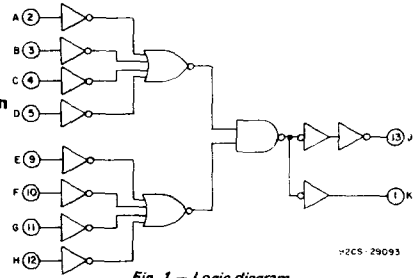

Fig. 1 - Logic diagram.

**STATIC ELECTRICAL CHARACTERISTICS**

CHARACTERISTIC	CONDITIONS			LIMITS AT INDICATED TEMPERATURES (°C)							UNITS
				Values at -55, +25, +125 Apply to D, F, K, H Packages				Values at -40, +25, +85 Apply to E Package			
	$V_O$ (V)	$V_{IN}$ (V)	$V_{DD}$ (V)	-55	-40	+85	+125	Min.	Typ.	Max.	
Quiescent Device Current, $I_{DD}$ Max.	-	0,5	5	0.25	0.25	7.5	7.5	-	0.01	0.25	$\mu$ A
	-	0,10	10	0.5	0.5	15	15	-	0.01	0.5	
	-	0,15	15	1	1	30	30	-	0.01	1	
	-	0,20	20	5	5	150	150	-	0.02	5	
Output Low (Sink) Current $I_{OL}$ Min.	0.4	0,5	5	0.64	0.61	0.42	0.36	0.51	1	-	mA
	0.5	0,10	10	1.6	1.5	1.1	0.9	1.3	2.6	-	
	1.5	0,15	15	4.2	4	2.8	2.4	3.4	6.8	-	
Output High (Source) Current, $I_{OH}$ Min.	4.6	0,5	5	-0.64	-0.61	-0.42	-0.36	-0.51	-1	-	mA
	2.5	0,5	5	-2	-1.8	-1.3	-1.15	-1.6	-3.2	-	
	9.5	0,10	10	-1.6	-1.5	-1.1	-0.9	-1.3	-2.6	-	
	13.5	0,15	15	-4.2	-4	-2.8	-2.4	-3.4	-6.8	-	
Output Voltage: Low-Level, $V_{OL}$ Max.	-	0,5	5	0.05			-			0	V
	-	0,10	10	0.05			-			0	
	-	0,15	15	0.05			-			0	
Output Voltage: High-Level, $V_{OH}$ Min.	-	0,5	5	4.95			4.95			5	V
	-	0,10	10	9.95			9.95			10	
	-	0,15	15	14.95			14.95			15	
Input Low Voltage, $V_{IL}$ Max.	0.5,4.5	-	5	1.5			-			1.5	V
	1.9	-	10	3			-			3	
	1.5,13.5	-	15	4			-			4	
Input High Voltage, $V_{IH}$ Min.	0.5,4.5	-	5	3.5			3.5			-	V
	1.9	-	10	7			7			-	
	1.5,13.5	-	15	11			11			-	
Input Current $I_{IN}$ Max.		0,18	18	$\pm 0.1$	$\pm 0.1$	$\pm 1$	$\pm 1$	-	$\pm 10^{-5}$	$\pm 0.1$	$\mu$ A

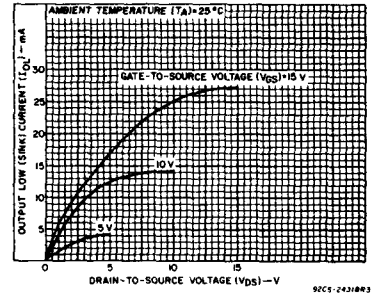

Fig. 2 - Typical output low (sink) current characteristics.

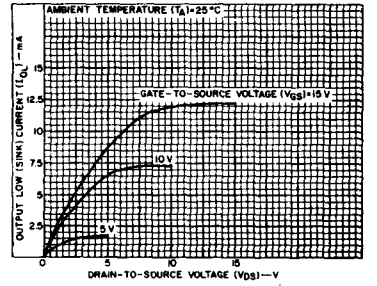

Fig. 3 - Minimum output low (sink) current characteristics.

# CD4068B Types

## MAXIMUM RATINGS, Absolute-Maximum Values:

DC SUPPLY-VOLTAGE RANGE, ( $V_{DD}$ )	-0.5 to +20 V
(Voltages referenced to $V_{SS}$ Terminal)	
INPUT VOLTAGE RANGE, ALL INPUTS	-0.5 to $V_{DD} + 0.5$ V
DC INPUT CURRENT, ANY ONE INPUT	$\pm 10$ mA
POWER DISSIPATION PER PACKAGE ( $P_D$ ):	
For $T_A = -40$ to $+60^\circ\text{C}$ (PACKAGE TYPE E)	500 mW
For $T_A = +60$ to $+85^\circ\text{C}$ (PACKAGE TYPE E)	Derate Linearly at 12 mW/ $^\circ\text{C}$ to 200 mW
For $T_A = -55$ to $+100^\circ\text{C}$ (PACKAGE TYPES D, F, K)	500 mW
For $T_A = +100$ to $+125^\circ\text{C}$ (PACKAGE TYPES D, F, K)	Derate Linearly at 12 mW/ $^\circ\text{C}$ to 200 mW
DEVICE DISSIPATION PER OUTPUT TRANSISTOR:	
For $T_A = \text{FULL PACKAGE-TEMPERATURE RANGE}$ (All Package Types)	100 mW
OPERATING-TEMPERATURE RANGE ( $T_A$ ):	
PACKAGE TYPES D, F, K, H	-55 to $+125^\circ\text{C}$
PACKAGE TYPE E	-40 to $+85^\circ\text{C}$
STORAGE TEMPERATURE RANGE ( $T_{stg}$ )	-65 to $+150^\circ\text{C}$
LEAD TEMPERATURE (DURING SOLDERING):	
At distance 1/16 $\pm$ 1/32 inch (1.59 $\pm$ 0.79 mm) from case for 10 s max.	$+265^\circ\text{C}$

## DYNAMIC ELECTRICAL CHARACTERISTICS

At  $T_A = 25^\circ\text{C}$ ; Input  $t_r, t_f = 20$  ns,  $C_L = 50$  pF,  $R_L = 200k\Omega$

CHARACTERISTIC	TEST CONDITIONS	ALL TYPES LIMITS		UNITS	
		$V_{DD}$ VOLTS	TYP.		MAX.
Propagation Delay Time, $t_{PHL}, t_{PLH}$		5	150	300	ns
		10	75	150	
		15	55	110	
Transition Time, $t_{THL}, t_{TLH}$		5	100	200	ns
		10	50	100	
		15	40	80	
Input Capacitance, $C_{IN}$	Any Input	5	7.5	pF	

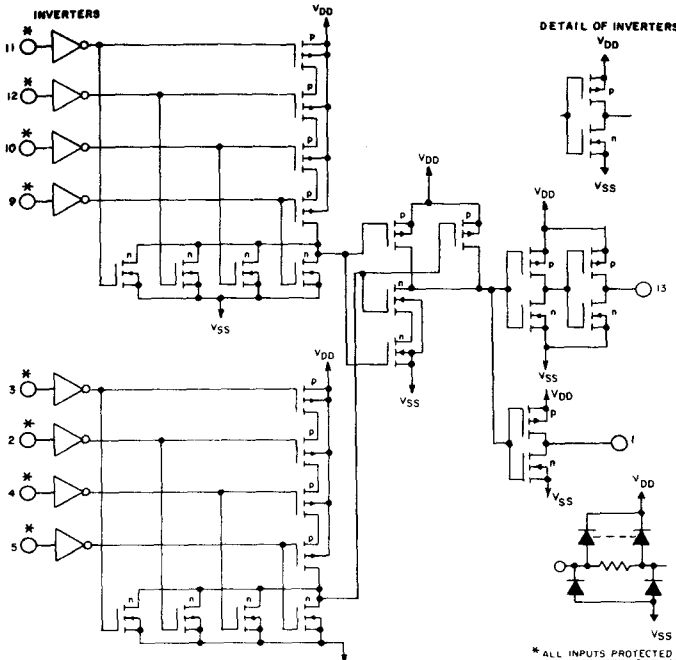

Fig. 7 - Schematic diagram.

92CM-29094

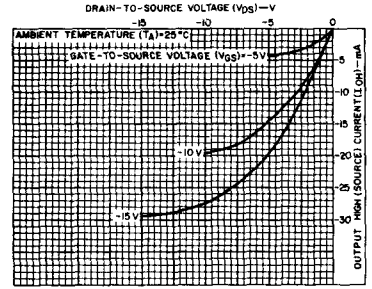

Fig. 4 - Typical output high (source) current characteristics.

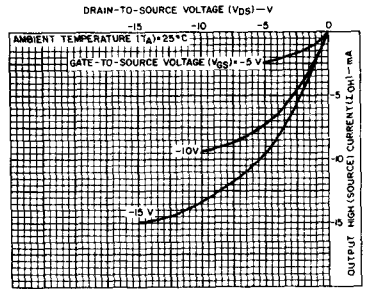

Fig. 5 - Minimum output high (source) current characteristics.

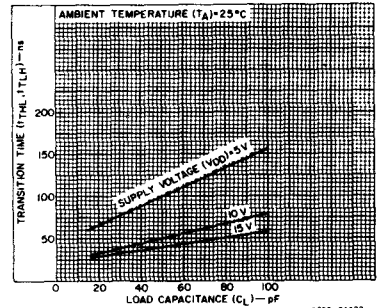

Fig. 6 - Typical transition time as a function of load capacitance.

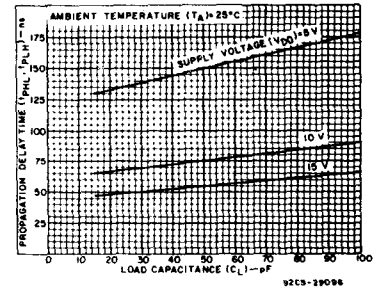

Fig. 8 - Typical propagation delay time as a function of load capacitance.



# CD4068B Types

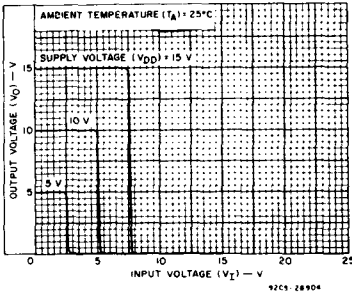

Fig. 9 - Typical voltage transfer characteristics (NAND output).

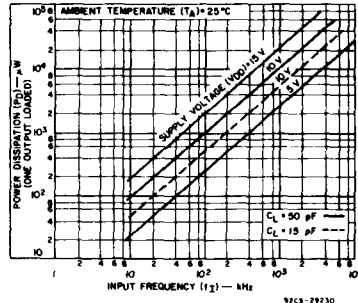

Fig. 10 - Typical dynamic power dissipation as a function of frequency.

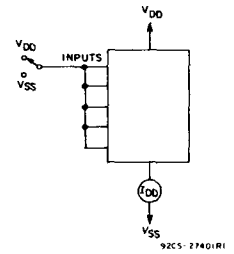

Fig. 11 - Quiescent-device-current test circuit.

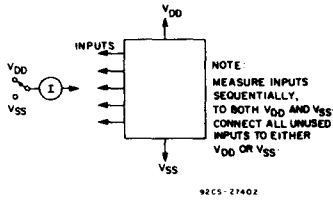

Fig. 12 - Input current test circuit.

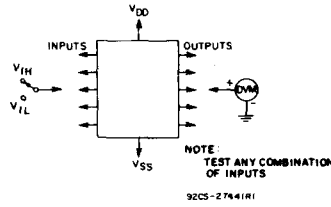

Fig. 13 - Input-voltage test circuit.

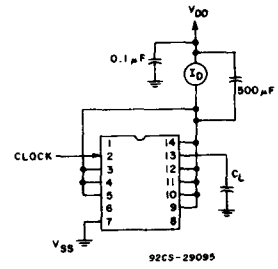
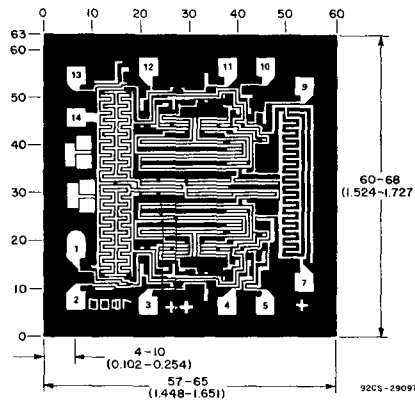

Fig. 14 - Dynamic power dissipation test circuit.



Dimensions and pad layout for CD4068BH.

Dimensions in parentheses are in millimeters and are derived from the basic inch dimensions as indicated. Grid graduations are in mils (10<sup>-3</sup> inch).

The photographs and dimensions of each CMOS chip represent a chip when it is part of the wafer. When the wafer is separated into individual chips, the angle of cleavage may vary with respect to the chip face for different chips. The actual dimensions of the isolated chip, therefore, may differ slightly from the nominal dimensions shown. The user should consider a tolerance of -3 mils to +16 mils applicable to the nominal dimensions shown.

# CD4069UB Types

## CMOS Hex Inverter

High-Voltage Types (20-Volt Rating)

The RCA-CD4069UB types consist of six CMOS inverter circuits. These devices are intended for all general-purpose inverter applications where the medium-power TTL-drive and logic-level-conversion capabilities of circuits such as the CD4009 and CD4049 Hex Inverter/Buffers are not required.

The CD4069UB-Series types are supplied in 14-lead hermetic dual-in-line ceramic packages (D and F suffixes), 14-lead dual-in-line plastic package (E suffix), 14-lead ceramic flat package (K suffix), and in chip form (H suffix).

### Features:

- Standardized symmetrical output characteristics
- Medium Speed Operation— $t_{PHL}, t_{PLH} = 30$  ns (typ.) at 10 V
- 100% tested for quiescent current at 20 V
- Maximum input current of 1  $\mu$ A at 18 V over full package-temperature range; 100 nA at 18 V and 25°C
- Meets all requirements of JEDEC Tentative Standard No. 13A, "Standard Specifications for Description of 'B' Series CMOS Devices"

### Applications:

- Logic inversion
- Pulse shaping
- Oscillators
- High-input-impedance amplifiers

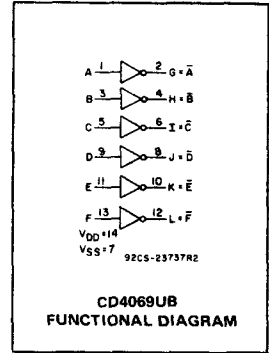

### RECOMMENDED OPERATING CONDITIONS

For maximum reliability, nominal operating conditions should be selected so that operation is always within the following ranges:

CHARACTERISTIC	LIMITS		UNITS
	Min.	Max.	
Supply-Voltage Range (For $T_A =$ Full Package Temperature Range)	3	18	V

### MAXIMUM RATINGS, Absolute-Maximum Values:

DC SUPPLY-VOLTAGE RANGE, ( $V_{DD}$ ) (Voltages referenced to $V_{SS}$ Terminal)	-0.5 to +20 V
INPUT VOLTAGE RANGE, ALL INPUTS	-0.5 to $V_{DD} + 0.5$ V
DC INPUT CURRENT, ANY ONE INPUT	$\pm 10$ mA
POWER DISSIPATION PER PACKAGE ( $P_D$ ):	
For $T_A = -40$ to $+60^\circ\text{C}$ (PACKAGE TYPE E)	500 mW
For $T_A = +60$ to $+85^\circ\text{C}$ (PACKAGE TYPE E)	Derate Linearly at 12 mW/ $^\circ\text{C}$ to 200 mW
For $T_A = -55$ to $+100^\circ\text{C}$ (PACKAGE TYPES D, F, K)	500 mW
For $T_A = +100$ to $+125^\circ\text{C}$ (PACKAGE TYPES D, F, K)	Derate Linearly at 12 mW/ $^\circ\text{C}$ to 200 mW
DEVICE DISSIPATION PER OUTPUT TRANSISTOR FOR $T_A =$ FULL PACKAGE-TEMPERATURE RANGE (All Package Types)	100 mW
OPERATING-TEMPERATURE RANGE ( $T_A$ ):	
PACKAGE TYPES D, F, K, H	-55 to $+125^\circ\text{C}$
PACKAGE TYPE E	-40 to $+85^\circ\text{C}$
STORAGE TEMPERATURE RANGE ( $T_{stg}$ )	-65 to $+150^\circ\text{C}$
LEAD TEMPERATURE (DURING SOLDERING):	
At distance $1/16 \pm 1/32$ inch ( $1.59 \pm 0.79$ mm) from case for 10 s max.	$+265^\circ\text{C}$

DYNAMIC ELECTRICAL CHARACTERISTICS at  $T_A = 25^\circ\text{C}$ ; Input  $t_r, t_f = 20$  ns,

$C_L = 50$  pF,  $R_L = 200$  K $\Omega$

CHARACTERISTIC	CONDITIONS	ALL TYPES LIMITS		UNITS	
		$V_{DD}$ V	Typ.		Max.
Propagation Delay Time, $t_{PLH}, t_{PHL}$		5	55	110	ns
		10	30	60	
		15	25	50	
Transition Time, $t_{THL}, t_{TLH}$		5	100	200	ns
		10	50	100	
		15	40	80	
Input Capacitance, $C_{IN}$	Any Input	10	15	pF	

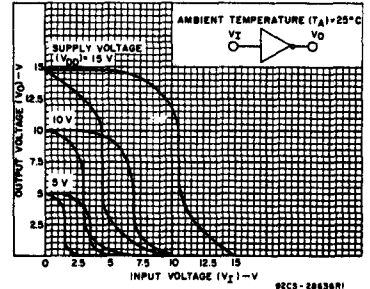

Fig. 1 — Minimum and maximum voltage transfer characteristics.

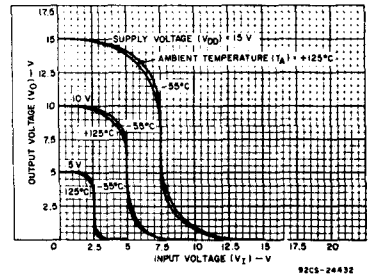

Fig. 2 — Typical voltage transfer characteristics as a function of temperature.

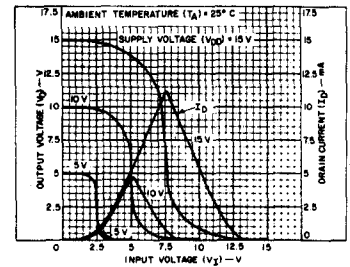

Fig. 3 — Typical current and voltage transfer characteristics.

# CD4069UB Types

## STATIC ELECTRICAL CHARACTERISTICS

CHARACTERISTIC	CONDITIONS			LIMITS AT INDICATED TEMPERATURES (°C)							UNITS
	V <sub>O</sub> (V)	V <sub>IN</sub> (V)	V <sub>DD</sub> (V)	Values at -55, +25, +125 Apply to D,F,K,H Packages				Values at -40, +25, +85 Apply to E Package			
				-55	-40	+85	+125	Min.	Typ.	Max.	
Quiescent Device Current, I <sub>DD</sub> Max.	-	0,5	5	0.25	0.25	7.5	7.5	-	0.01	0.25	μA
	-	0,10	10	0.5	0.5	15	15	-	0.01	0.5	
	-	0,15	15	1	1	30	30	-	0.01	1	
	-	0,20	20	5	5	150	150	-	0.02	5	
Output Low (Sink) Current I <sub>OL</sub> Min.	0.4	0,5	5	0.64	0.61	0.42	0.36	0.51	1	-	mA
	0.5	0,10	10	1.6	1.5	1.1	0.9	1.3	2.6	-	
	1.5	0,15	15	4.2	4	2.8	2.4	3.4	6.8	-	
Output High (Source) Current, I <sub>OH</sub> Min.	4.6	0,5	5	-0.64	-0.61	-0.42	-0.36	-0.51	-1	-	mA
	2.5	0,5	5	-2	-1.8	-1.3	-1.15	-1.6	-3.2	-	
	9.5	0,10	10	-1.6	-1.5	-1.1	-0.9	-1.3	-2.6	-	
	13.5	0,15	15	-4.2	-4	-2.8	-2.4	-3.4	-6.8	-	
Output Voltage: Low-Level, V <sub>OL</sub> Max.	-	5	5	0.05				-	0	0.05	V
	-	10	10	0.05				-	0	0.05	
	-	15	15	0.05				-	0	0.05	
Output Voltage: High-Level, V <sub>OH</sub> Min.	-	0	5	4.95				4.95	5	-	V
	-	0	10	9.95				9.95	10	-	
	-	0	15	14.95				14.95	15	-	
Input Low Voltage, V <sub>IL</sub> Max.	4.5	-	5	1				-	-	1	V
	9	-	10	2				-	-	2	
	13.5	-	15	2.5				-	-	2.5	
Input High Voltage, V <sub>IH</sub> Min.	0.5	-	5	4				4	-	-	V
	1	-	10	8				8	-	-	
	1.5	-	15	12.5				12.5	-	-	
Input Current I <sub>IN</sub> Max.		0,18	18	±0.1	±0.1	±1	±1	-	±10 <sup>-5</sup>	±0.1	μA

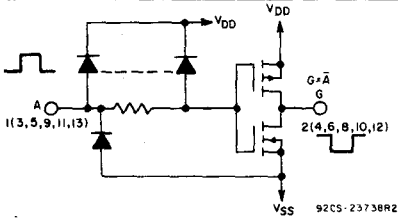

Fig. 6 - Schematic diagram of one of six identical inverters.

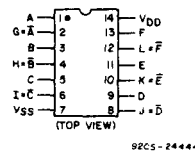

Fig. 7 - CD4069UB terminal assignment.

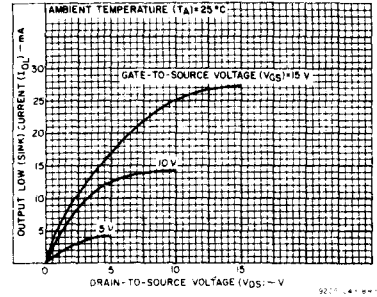

Fig. 4 - Typical output low (sink) current characteristics.

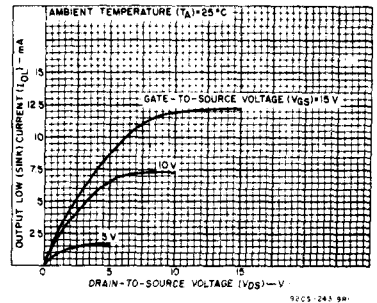

Fig. 5 - Minimum output low (sink) current characteristics.

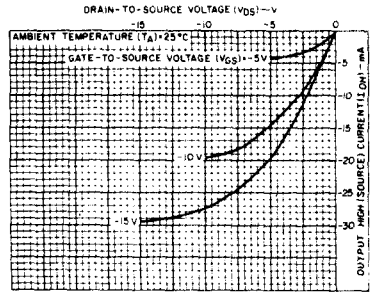

Fig. 8 - Typical output high (source) current characteristics.

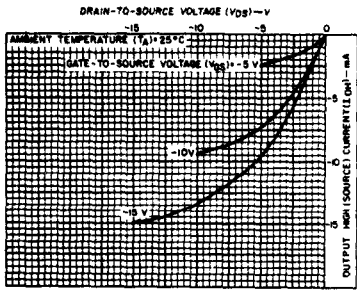

Fig. 9 - Minimum output high (source) current characteristics.

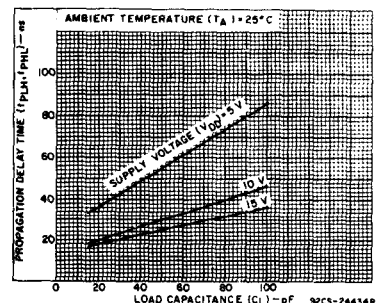

Fig. 10 - Typical propagation delay time vs. load capacitance.

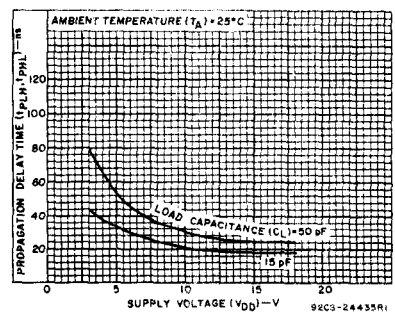

Fig. 11 - Typical propagation delay time vs. supply voltage.

# CD4069UB Types

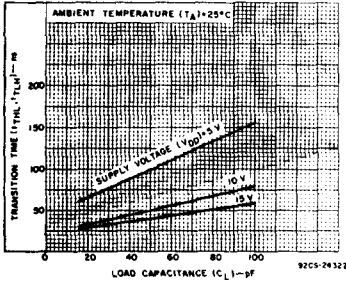

Fig. 12 - Typical transition time vs. load capacitance.

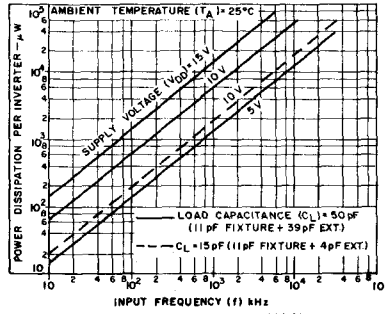

Fig. 13 - Typical dynamic power dissipation vs. frequency.

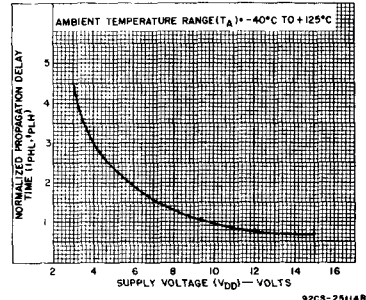

Fig. 14 - Variation of normalized propagation delay time ( $t_{PLH}$  and  $t_{PLL}$ ) with supply voltage.

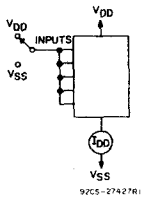

Fig. 15 - Quiescent device current test circuit.

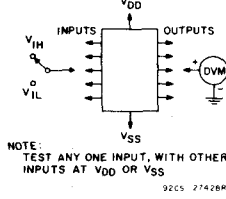

Fig. 16 - Noise immunity test circuit.

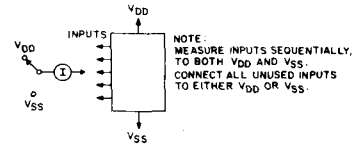

Fig. 17 - Input leakage current test circuit.

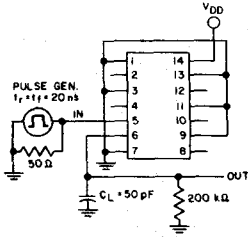
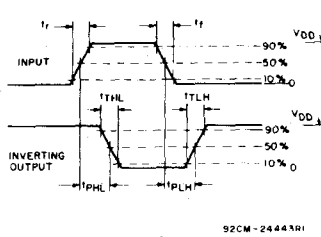

Fig. 18 - Dynamic electrical characteristics test circuit and waveforms.



92CM-24447R1

## APPLICATIONS

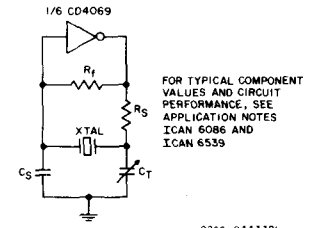

Fig. 19 - Typical crystal oscillator circuit.

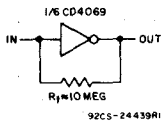

Fig. 20 - High-input impedance amplifier.

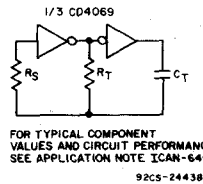

Fig. 21 - Typical RC oscillator circuit.

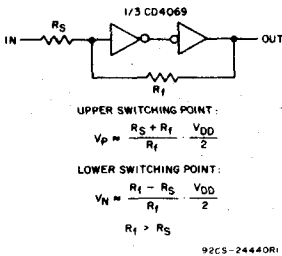

Fig. 22 - Input pulse shaping circuit (Schmitt trigger).

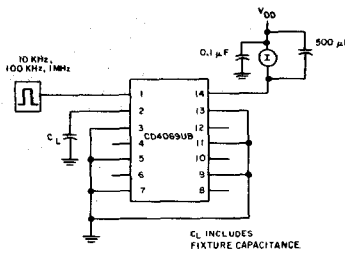
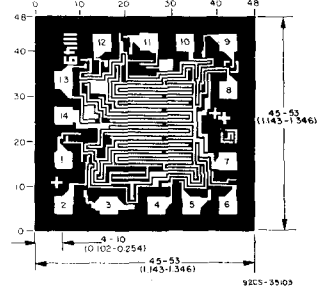

Fig. 23 - Dynamic power dissipation test circuit.



Dimensions and pad layout for CD4069UBH.

Dimensions in parentheses are in millimeters and are derived from the basic inch dimensions as indicated. Grid graduations are in mils ( $10^{-3}$  inch).

The photographs and dimensions of each CMOS chip represent a chip when it is part of the wafer. When the wafer is separated into individual chips, the angle of cleavage may vary with respect to the chip face for different chips. The actual dimensions of the isolated chip, therefore, may differ slightly from the nominal dimensions shown. The user should consider a tolerance of  $\pm 3$  mils to  $\pm 16$  mils applicable to the nominal dimensions shown.

## CMOS Quad Exclusive-OR and Exclusive-NOR Gates

High-Voltage Types (20-Volt Rating)

CD4070B — Quad Exclusive-OR Gate  
CD4077B — Quad Exclusive-NOR Gate

The RCA-CD4070B contains four independent Exclusive-OR gates. The RCA-CD4077B contains four independent Exclusive-NOR gates.

The CD4070B and CD4077B provide the system designer with a means for direct implementation of the Exclusive-OR and Exclusive-NOR functions, respectively.

The CD4070B and CD4077B types are supplied in 14-lead hermetic dual-in-line ceramic packages (D and F suffixes), 14-lead dual-in-line plastic packages (E suffix), 14-lead ceramic flat packages (K suffix), and in chip form (H suffix).

### MAXIMUM RATINGS, Absolute-Maximum Values:

DC SUPPLY-VOLTAGE RANGE, ( $V_{DD}$ ) (Voltages referenced to $V_{SS}$ Terminal)	-0.5 to +20 V
INPUT VOLTAGE RANGE, ALL INPUTS	-0.5 to $V_{DD}$ + 0.5 V
DC INPUT CURRENT, ANY ONE INPUT	±10 mA
POWER DISSIPATION PER PACKAGE ( $P_D$ ):	
For $T_A = -40$ to $+60^\circ\text{C}$ (PACKAGE TYPE E)	500 mW
For $T_A = +60$ to $+85^\circ\text{C}$ (PACKAGE TYPE E)	Derate Linearly at 12 mW/ $^\circ\text{C}$ to 200 mW
For $T_A = -55$ to $+100^\circ\text{C}$ (PACKAGE TYPES D, F, K)	500 mW
For $T_A = +100$ to $+125^\circ\text{C}$ (PACKAGE TYPES D, F, K)	Derate Linearly at 12 mW/ $^\circ\text{C}$ to 200 mW
DEVICE DISSIPATION PER OUTPUT TRANSISTOR FOR $T_A =$ FULL PACKAGE-TEMPERATURE RANGE (All Package Types)	100 mW
OPERATING-TEMPERATURE RANGE ( $T_A$ ):	
PACKAGE TYPES D, F, K, H	-55 to $+125^\circ\text{C}$
PACKAGE TYPE E	-40 to $+85^\circ\text{C}$
STORAGE TEMPERATURE RANGE ( $T_{stg}$ )	-65 to $+150^\circ\text{C}$
LEAD TEMPERATURE (DURING SOLDERING):	
At distance 1/16 ± 1/32 inch (1.59 ± 0.79 mm) from case for 10 s max.	+265 $^\circ\text{C}$

### Features:

- Medium-speed operation— $t_{PHL}$ ,  $t_{PLH} = 65$  ns (typ.) at  $V_{DD} = 10$  V,  $C_L = 50$  pF
- 100% tested for quiescent current at 20 V
- Standardized symmetrical output characteristics
- 5-V, 10-V, and 15-V parametric ratings
- Maximum input current of 1  $\mu\text{A}$  at 18 V over full package-temperature range; 100 nA at 18 V and 25 $^\circ\text{C}$
- Noise margin (over full package-temperature range):
  - 1 V at  $V_{DD} = 5$  V
  - 2 V at  $V_{DD} = 10$  V
  - 2.5 V at  $V_{DD} = 15$  V

■ Meets all requirements of JEDEC Tentative Standard No. 13A, "Standard Specifications for Description of 'B' Series CMOS Devices"

### Applications:

- Logical comparators
- Adders/subtractors
- Parity generators and checkers

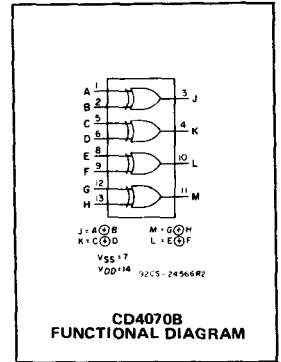

CD4070B  
FUNCTIONAL DIAGRAM

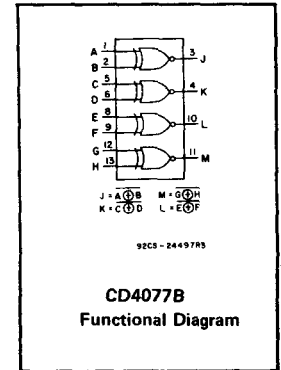

CD4077B  
Functional Diagram

### RECOMMENDED OPERATING CONDITIONS

For maximum reliability, nominal operating conditions should be selected so that operation is always within the following ranges:

Characteristic	Min.	Max.	Units
Supply-Voltage Range (For $T_A =$ Full Package-Temperature Range)	3	18	V

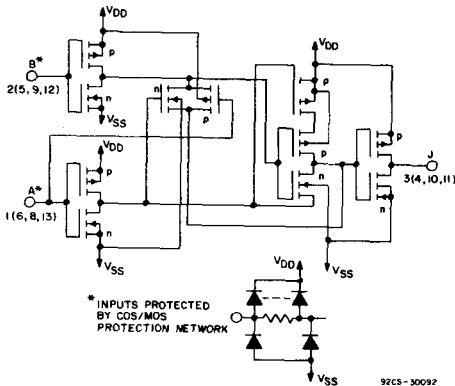
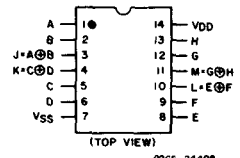

Fig. 1 — Schematic diagram for CD4070B (1 of 4 identical gates).

### TRUTH TABLE CD4070B 1 of 4 Gates

A	B	J
0	0	0
1	0	1
0	1	1
1	1	0

1 = HIGH LEVEL  
0 = LOW LEVEL  
J = A ⊕ B



### TERMINAL ASSIGNMENT CD4070B

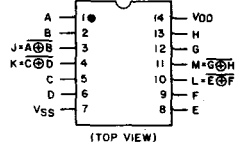

### TERMINAL ASSIGNMENT CD4077B

# CD4070B, CD4077B Types

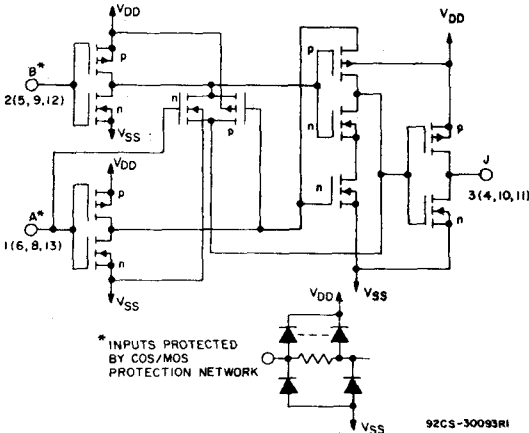

Fig. 2 - Schematic diagram for CD4077B (1 of 4 identical gates).

### TRUTH TABLE CD4077B

1 of 4 Gates

A	B	J
0	0	1
1	0	0
0	1	0
1	1	1

1 = HIGH LEVEL  
 0 = LOW LEVEL  
 J = A ⊕ B

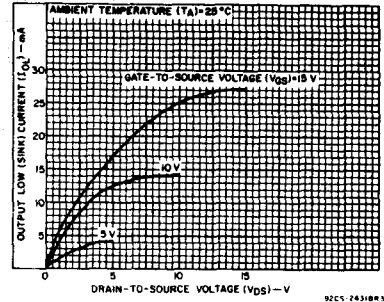

Fig. 3 - Typical output low (sink) current characteristics.

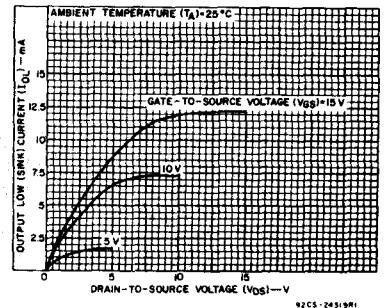

Fig. 4 - Minimum output low (sink) current characteristics.

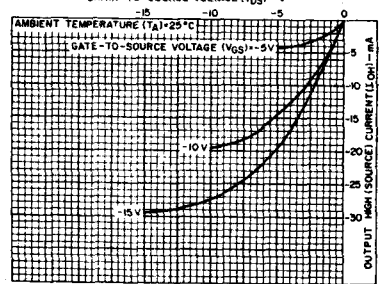

Fig. 5 - Typical output high (source) current characteristics.

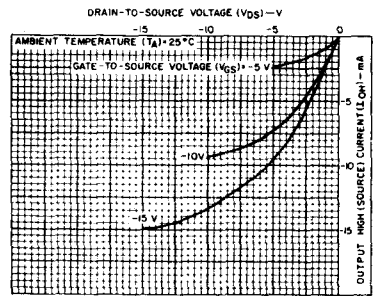

Fig. 6 - Minimum output high (source) current characteristics.

## STATIC ELECTRICAL CHARACTERISTICS

CHARACTERISTIC	CONDITIONS			LIMITS AT INDICATED TEMPERATURES (°C)							UNITS
	V <sub>O</sub> (V)	V <sub>IN</sub> (V)	V <sub>DD</sub> (V)	Values at -55, +25, +125 Apply to D, F, K, H Pkgs.				Values at -40, +25, +85 Apply to E Pkgs.			
				-55	-40	+85	+125	Min.	Typ.	Max.	
Quiescent Device Current	-	0.5	5	1	1	30	30	-	0.02	1	μA
Current	-	0.10	10	2	2	60	60	-	0.02	2	
I <sub>DD</sub> Max.	-	0.15	15	4	4	120	120	-	0.02	4	
Output Low (Sink) Current, I <sub>OL</sub> Min.	0.4	0.5	5	0.64	0.61	0.42	0.36	0.51	1	-	mA
Current	0.5	0.10	10	1.6	1.5	1.1	0.9	1.3	2.6	-	
I <sub>OL</sub> Max.	1.5	0.15	15	4.2	4	2.8	2.4	3.4	6.8	-	
Output High (Source) Current, I <sub>OH</sub> Min.	4.6	0.5	5	-0.64	-0.61	-0.42	-0.36	-0.51	-1	-	mA
Current	2.5	0.5	5	-2	-1.8	-1.3	-1.15	-1.6	-3.2	-	
I <sub>OH</sub> Max.	9.5	0.10	10	-1.6	-1.5	-1.1	-0.9	-1.3	-2.6	-	
Output Voltage: Low-Level, V <sub>OL</sub> Max.	-	0.5	5		0.05			-	0	0.05	V
Low-Level	-	0.10	10		0.05			-	0	0.05	
V <sub>OL</sub> Max.	-	0.15	15		0.05			-	0	0.05	
Output Voltage: High-Level, V <sub>OH</sub> Min.	-	0.5	5		4.95			4.95	5	-	V
High-Level	-	0.10	10		9.95			9.95	10	-	
V <sub>OH</sub> Min.	-	0.15	15		14.95			14.95	15	-	
Input Low Voltage, V <sub>IL</sub> Max.	0.5, 4.5	-	5		1.5			-	-	1.5	V
Voltage	1.9	-	10		3			-	-	3	
V <sub>IL</sub> Max.	1.5, 13.5	-	15		4			-	-	4	
Input High Voltage, V <sub>IH</sub> Min.	0.5, 4.5	-	5		3.5			3.5	-	-	V
Voltage	1.9	-	10		7			7	-	-	
V <sub>IH</sub> Min.	1.5, 13.5	-	15		11			11	-	-	
Input Current, I <sub>IN</sub> Max.	-	0.18	18	±0.1	±0.1	±1	±1	-	±10 <sup>-5</sup>	±0.1	μA

# CD4070B, CD4077B Types

**DYNAMIC ELECTRICAL CHARACTERISTICS** at  $T_A = 25^\circ\text{C}$ ; Input  $t_r, t_f = 20 \text{ ns}$ ,  
 $C_L = 50 \text{ pF}$ ,  $R_L = 200 \text{ k}\Omega$

CHARACTERISTIC	CONDITIONS	ALL TYPES LIMITS		UNITS
		$V_{DD}$ V	Typ.	
Propagation Delay Time; $t_{pHL}, t_{pLH}$	5	140	280	ns
	10	65	130	
	15	50	100	
Transition Time; $t_{THL}, t_{TLH}$	5	100	200	ns
	10	50	100	
	15	40	80	
Input Capacitance; $C_{iN}$	Any Input	5	7.5	pF

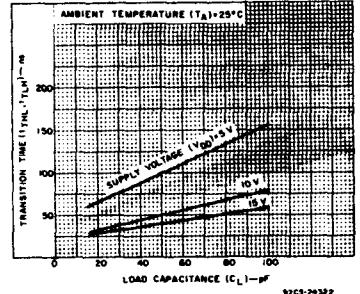

Fig. 7 - Typical transition time as a function of load capacitance.

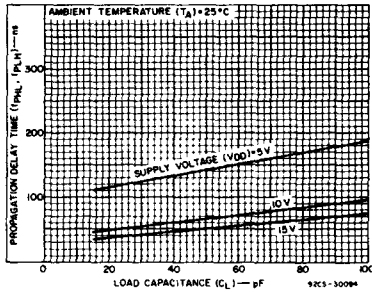

Fig. 8 - Typical propagation delay time as a function of load capacitance.

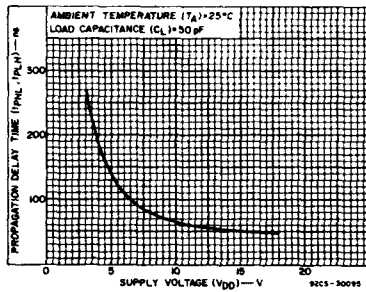

Fig. 9 - Typical propagation delay time as a function of supply voltage.

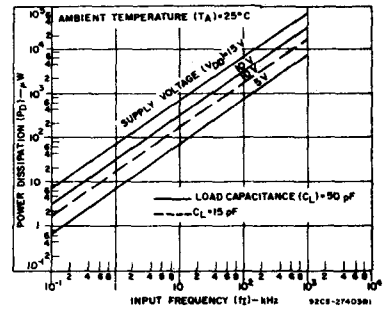
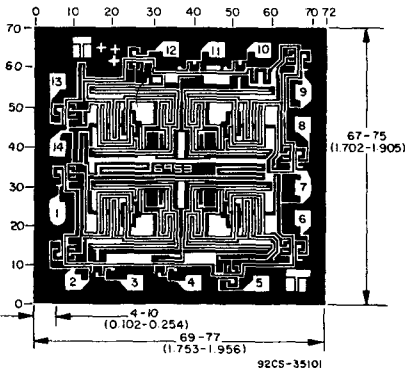

Fig. 10 - Typical dynamic power dissipation as a function of input frequency.



Dimensions and pad layout for CD4077B.  
 Dimensions and pad layout for CD4070B are identical.

Dimensions in parentheses are in millimeters and are derived from the basic inch dimensions as indicated. Grid graduations are in mils ( $10^{-3}$  inch).

The photographs and dimensions of each CMOS chip represent a chip when it is part of the wafer. When the wafer is separated into individual chips, the angle of cleavage may vary with respect to the chip face for different chips. The actual dimensions of the isolated chip, therefore, may differ slightly from the nominal dimensions shown. The user should consider a tolerance of  $\pm 3$  mils to  $\pm 16$  mils applicable to the nominal dimensions shown.

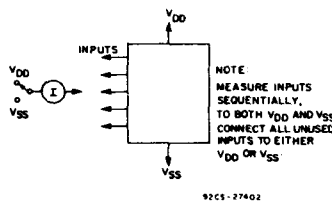

Fig. 11 - Input current test circuit.

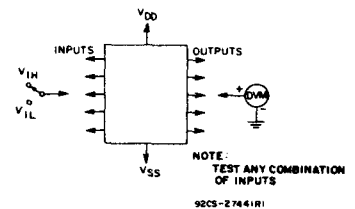

Fig. 12 - Input-voltage test circuit.

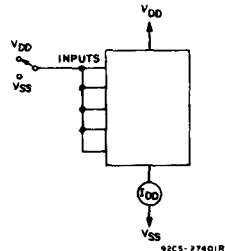

Fig. 13 - Quiescent device current test circuit.

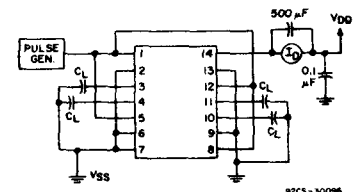

Fig. 14 - Dynamic power dissipation test circuit.

# CD4071B, CD4072B, CD4075B Types

## CMOS OR Gates

High-Voltage Types (20-Volt Rating)

CD4071B Quad 2-Input OR Gate

CD4072B Dual 4-Input OR Gate

CD4075B Triple 3-Input OR Gate

The RCA-CD4071B, CD4072B, and CD4075B OR gates provide the system designer with direct implementation of the positive-logic OR function and supplement the existing family of CMOS gates. The CD4071, CD4072, and CD4075 types are supplied in 14-lead dual-in-line ceramic packages (D and F suffixes), 14-lead dual-in-line plastic packages (E suffix), 14-lead ceramic flat packages (K suffix), and in chip form (H suffix).

### Features:

- Medium-Speed Operation- $t_{pLH}$ ,  $t_{pHL} = 60$  ns (typ.) at  $V_{DD} = 10$  V
- 100% tested for quiescent current at 20 V
- Maximum input current of  $1 \mu A$  at 18 V over full package-temperature range; 100 nA at 18 V and 25°C
- Standardized, symmetrical output characteristics
- Noise margin (over full package temperature range)
  - 1 V at  $V_{DD} = 5$  V
  - 2 V at  $V_{DD} = 10$  V
  - 2.5 V at  $V_{DD} = 15$  V
- 5-V, 10-V, and 15-V parametric ratings
- Meets all requirements of JEDEC Tentative Standard No. 13 A, "Standard Specifications for Description of 'B' Series CMOS Devices"

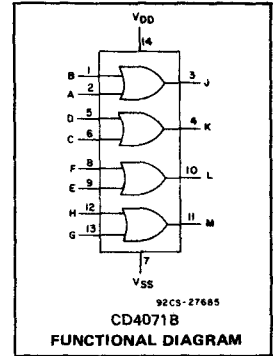

### RECOMMENDED OPERATING CONDITIONS

For maximum reliability, nominal operating conditions should be selected so that operation is always within the following ranges:

CHARACTERISTIC	LIMITS		UNITS
	MIN.	MAX.	
Supply-Voltage Range (For $T_A =$ Full Package-Temperature Range)	3	18	V

### STATIC ELECTRICAL CHARACTERISTICS

CHARACTERISTIC	CONDITIONS			LIMITS AT INDICATED TEMPERATURES (°C)							UNITS
	$V_O$ (V)	$V_{IN}$ (V)	$V_{DD}$ (V)	Values at -55, +25, +125 Apply to D, F, K, H Packages				Values at -40, +25, +85 Apply to E Package			
				-55	-40	+85	+125	+25			
				Min.	Typ.	Max.	Min.	Typ.	Max.		
Quiescent Device Current, $I_{DD}$ Max.	-	0,5	5	0.25	0.25	7.5	7.5	-	0.01	0.25	$\mu A$
	-	0,10	10	0.5	0.5	15	15	-	0.01	0.5	
	-	0,15	15	1	1	30	30	-	0.01	1	
Output Low (Sink) Current $I_{OL}$ Min.	0.4	0,5	5	0.64	0.61	0.42	0.36	0.51	1	-	mA
	0.5	0,10	10	1.6	1.5	1.1	0.9	1.3	2.6	-	
	1.5	0,15	15	4.2	4	2.8	2.4	3.4	6.8	-	
Output High (Source) Current, $I_{OH}$ Min.	4.6	0,5	5	-0.64	-0.61	-0.42	-0.36	-0.51	-1	-	mA
	2.5	0,5	5	-2	-1.8	-1.3	-1.15	-1.6	-3.2	-	
	9.5	0,10	10	-1.6	-1.5	-1.1	-0.9	-1.3	-2.6	-	
Output Voltage: Low-Level, $V_{OL}$ Max.	-	0,5	5			0.05		-	0	0.05	V
	-	0,10	10			0.05		-	0	0.05	
	-	0,15	15			0.05		-	0	0.05	
Output Voltage: High-Level, $V_{OH}$ Min.	-	0,5	5			4.95		4.95	5	-	V
	-	0,10	10			9.95		9.95	10	-	
	-	0,15	15			14.95		14.95	15	-	
Input Low Voltage, $V_{IL}$ Max.	0.5, 4.5	-	5			1.5		-	-	1.5	V
	1, 9	-	10			3		-	-	3	
	1.5, 13.5	-	15			4		-	-	4	
Input High Voltage, $V_{IH}$ Min.	4.5	-	5			3.5		3.5	-	-	V
	9	-	10			7		7	-	-	
	13.5	-	15			11		11	-	-	
Input Current $I_{IN}$ Max.		0,18	18	$\pm 0.1$	$\pm 0.1$	$\pm 1$	$\pm 1$	-	$\pm 10^{-5}$	$\pm 0.1$	$\mu A$

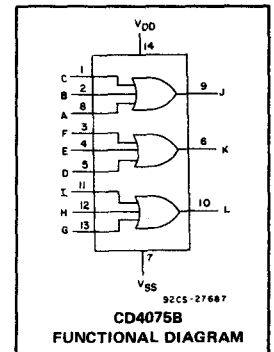
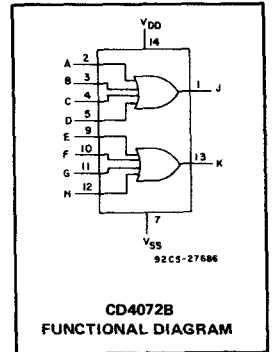



# CD4071B, CD4072B, CD4075B Types

## MAXIMUM RATINGS, Absolute-Maximum Values:

DC SUPPLY-VOLTAGE RANGE, ( $V_{DD}$ ) (Voltages referenced to $V_{SS}$ Terminal)	-0.5 to +20 V
INPUT VOLTAGE RANGE, ALL INPUTS	-0.5 to $V_{DD} + 0.5$ V
DC INPUT CURRENT, ANY ONE INPUT	$\pm 10$ mA
POWER DISSIPATION PER PACKAGE ( $P_D$ ):	
For $T_A = -40$ to $+60^\circ\text{C}$ (PACKAGE TYPE E)	500 mW
For $T_A = +60$ to $+85^\circ\text{C}$ (PACKAGE TYPE E)	Derate Linearly at 12 mW/ $^\circ\text{C}$ to 200 mW
For $T_A = -55$ to $+100^\circ\text{C}$ (PACKAGE TYPES D, F, K)	500 mW
For $T_A = +100$ to $+125^\circ\text{C}$ (PACKAGE TYPES D, F, K)	Derate Linearly at 12 mW/ $^\circ\text{C}$ to 200 mW
DEVICE DISSIPATION PER OUTPUT TRANSISTOR:	
For $T_A = \text{FULL PACKAGE-TEMPERATURE RANGE}$ (All Package Types)	100 mW
OPERATING-TEMPERATURE RANGE ( $T_A$ ):	
PACKAGE TYPES D, F, K, H	-55 to $+125^\circ\text{C}$
PACKAGE TYPE E	-40 to $+85^\circ\text{C}$
STORAGE TEMPERATURE RANGE ( $T_{stg}$ )	-65 to $+150^\circ\text{C}$
LEAD TEMPERATURE (DURING SOLDERING):	
At distance $1/16 \pm 1/32$ inch ( $1.59 \pm 0.79$ mm) from case for 10 s max.	$+265^\circ\text{C}$

DYNAMIC ELECTRICAL CHARACTERISTICS at  $T_A = 25^\circ\text{C}$ , Input  $t_r, t_f = 20$  ns, and  $C_L = 50$  pF,  $R_L = 200$  k $\Omega$

CHARACTERISTIC	TEST CONDITIONS	ALL TYPES LIMITS		UNITS	
		$V_{DD}$ VOLTS	TYP.		MAX.
Propagation Delay Time, $t_{PHL}, t_{PLH}$		5	125	250	ns
		10	60	120	
		15	45	90	
Transition Time, $t_{THL}, t_{TLH}$		5	100	200	ns
		10	50	100	
		15	40	80	
Input Capacitance, $C_{iN}$	Any Input	—	5	7.5	pF

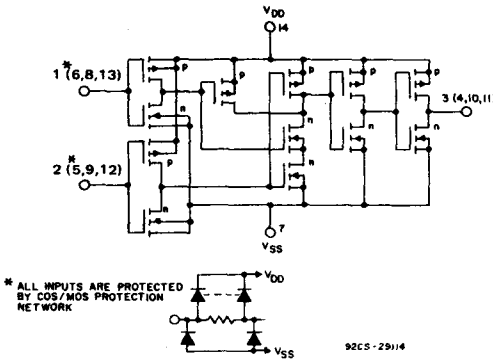

Fig. 3 - Schematic diagram for CD4071B (1 of 4 identical gates).

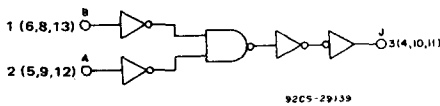

Fig. 5 - Logic diagram for CD4071B (1 of 4 identical gates).

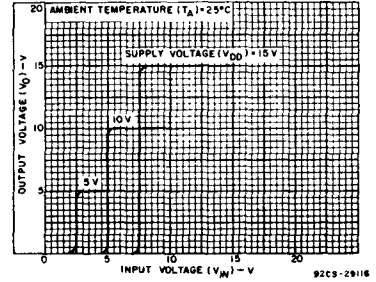

Fig. 1 - Typical voltage transfer characteristics.

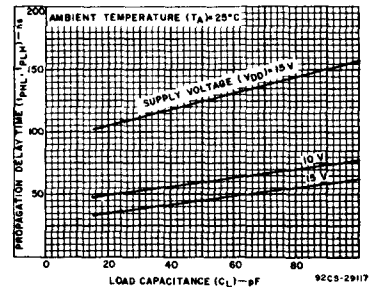

Fig. 2 - Typical propagation delay time as a function of load capacitance.

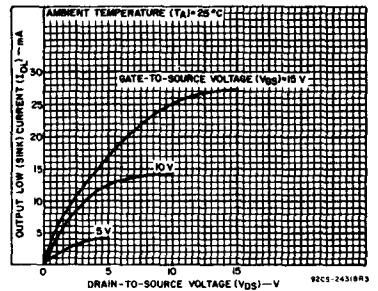

Fig. 4 - Typical output low (sink) current characteristics.

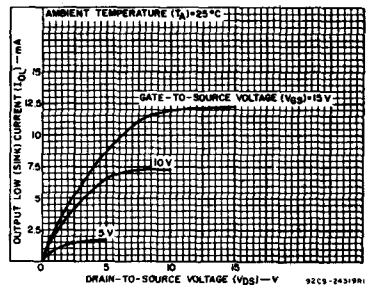

Fig. 6 - Minimum output low (sink) current characteristics.

# CD4071B, CD4072B, CD4075B Types

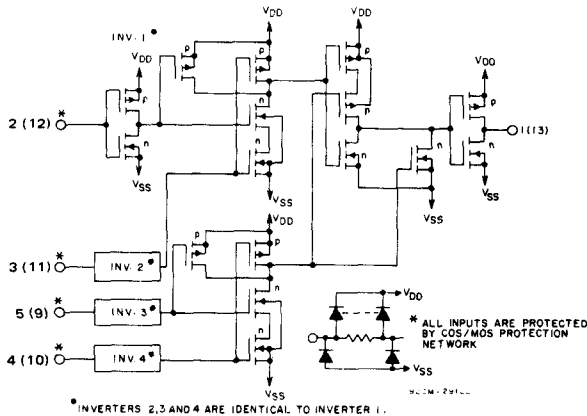

Fig. 7 - Schematic diagram for CD4072B (1 of 2 identical gates).

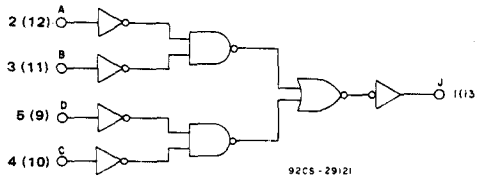

Fig. 9 - Logic diagram for CD4072B (1 of 2 identical gates).

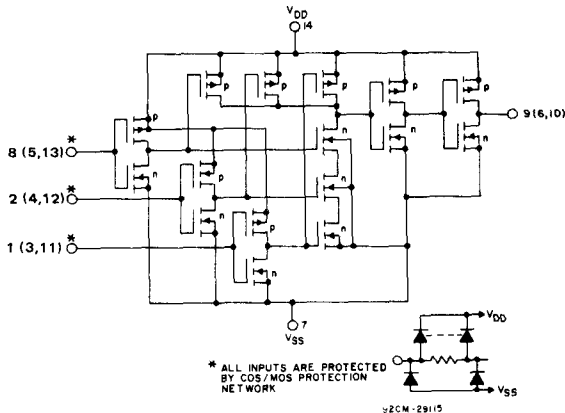

Fig. 11 - Schematic diagram for CD4075B (1 of 3 identical gates).

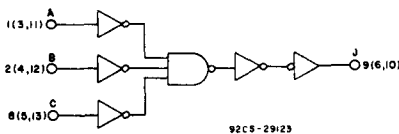

Fig. 13 - Logic diagram for CD4075B (1 of 3 identical gates).

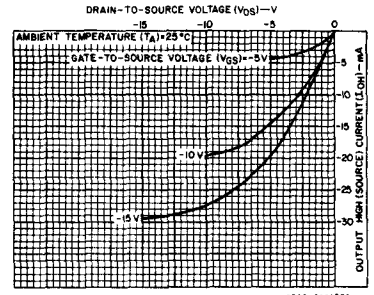

Fig. 8 - Typical output high (source) current characteristics.

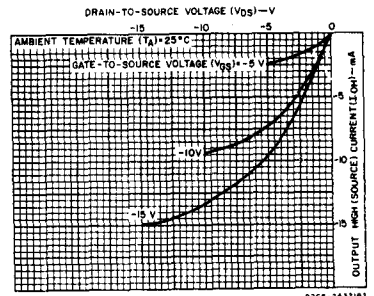

Fig. 10 - Minimum output high (source) current characteristics.

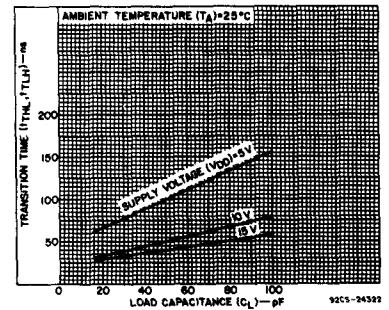

Fig. 12 - Typical transition time as a function of load capacitance.

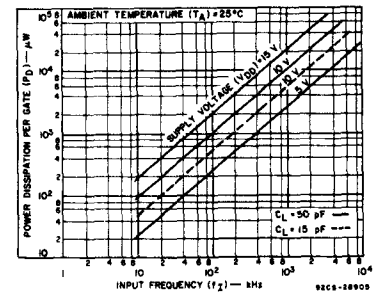

Fig. 14 - Typical dynamic power dissipation as a function of frequency.

# CD4071B, CD4072B, CD4075B Types

## TERMINAL ASSIGNMENTS (TOP VIEW)

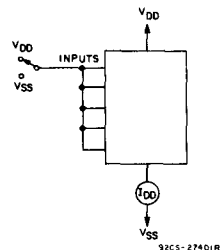
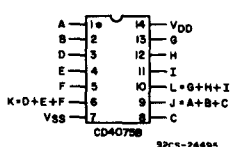
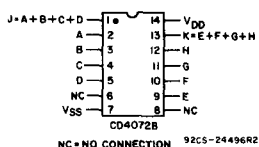
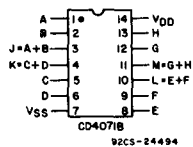

Fig. 15 - Quiescent device current test circuit.

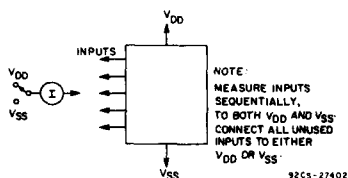

Fig. 16 - Input current test circuit.

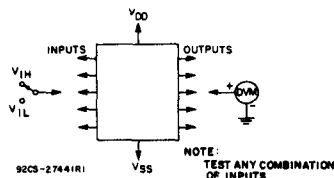
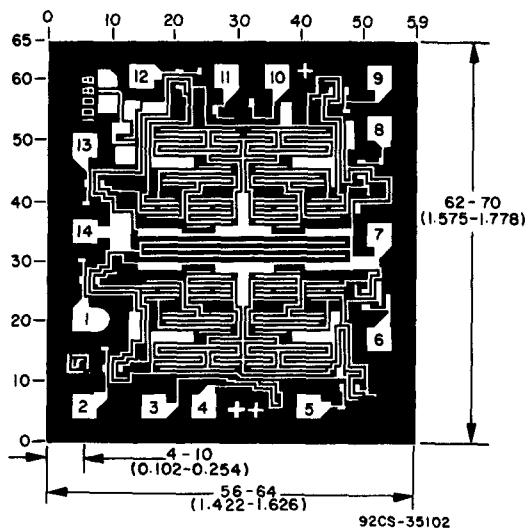

Fig. 17 - Input-voltage test circuit.

Dimensions in parentheses are in millimeters and are derived from the basic inch dimensions as indicated. Grid graduations are in mils ( $10^{-3}$  inch).

The photographs and dimensions of each CMOS chip represent a chip when it is part of the wafer. When the wafer is separated into individual chips, the angle of cleavage may vary with respect to the chip face for different chips. The actual dimensions of the isolated chip, therefore, may differ slightly from the nominal dimensions shown. The user should consider a tolerance of  $-3$  mils to  $+16$  mils applicable to the nominal dimensions shown.



Dimensions and pad layout for CD4071B.

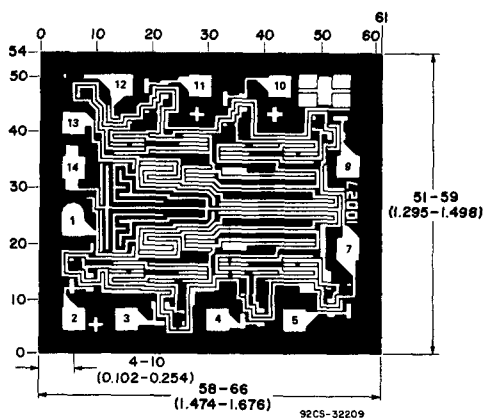

Dimensions and pad layout for CD4072B.

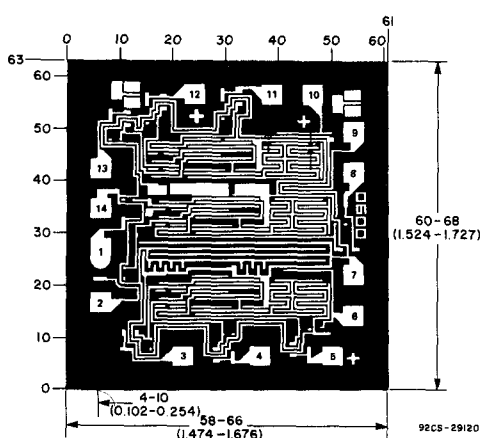

Dimensions and pad layout for CD4075B.

# CD4073B, CD4081B, CD4082B Types

## CMOS AND Gates

High-Voltage Types (20-Volt Rating)

CD4073B Triple 3-Input AND Gate  
 CD4081B Quad 2-Input AND Gate  
 CD4082B Dual 4-Input AND Gate

The FCA-CD4073B, CD4081B and CD4082B AND gates provide the system designer with direct implementation of the AND function and supplement the existing family of CMOS gates.

The CD4073B, CD4081B and CD4082B types are supplied in 14-lead dual-in-line ceramic packages (D and F suffixes), 14-lead dual-in-line plastic packages (E suffix), 14-lead ceramic flat packages (K suffix), and in chip form (H suffix).

### Features:

- Medium-Speed Operation —  $t_{PLH}$ ,  $t_{PHL} = 60$  ns (typ.) at  $V_{DD} = 10$  V
- 100% tested for quiescent current at 20 V
- Maximum input current of  $1 \mu A$  at 18 V over full package-temperature range; 100 nA at 18 V and 25°C
- Noise margin (full package-temperature range) =
  - 1 V at  $V_{DD} = 5$  V
  - 2 V at  $V_{DD} = 10$  V
  - 2.5 V at  $V_{DD} = 15$  V
- Standardized, symmetrical output characteristics
- 5-V, 10-V, and 15-V parametric ratings
- Meets all requirements of JEDEC Tentative Standard No. 13A, "Standard Specifications for Description of 'B' Series CMOS Devices"

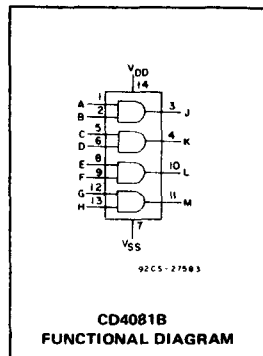

### MAXIMUM RATINGS, Absolute-Maximum Values:

DC SUPPLY-VOLTAGE RANGE, ( $V_{DD}$ ) (Voltages referenced to $V_{SS}$ Terminal)	-0.5 to +20 V
INPUT VOLTAGE RANGE, ALL INPUTS	-0.5 to $V_{DD} + 0.5$ V
DC INPUT CURRENT, ANY ONE INPUT	$\pm 10$ mA
POWER DISSIPATION PER PACKAGE ( $P_D$ ):	
For $T_A = -40$ to $+60^\circ C$ (PACKAGE TYPE E)	500 mW
For $T_A = +60$ to $+85^\circ C$ (PACKAGE TYPE E)	Derate Linearly at 12 mW/ $^\circ C$ to 200 mW
For $T_A = -55$ to $+100^\circ C$ (PACKAGE TYPES D, F, K)	500 mW
For $T_A = +100$ to $+125^\circ C$ (PACKAGE TYPES D, F, K)	Derate Linearly at 12 mW/ $^\circ C$ to 200 mW
DEVICE DISSIPATION PER OUTPUT TRANSISTOR	
FOR $T_A =$ FULL PACKAGE-TEMPERATURE RANGE (All Package Types)	100 mW
OPERATING-TEMPERATURE RANGE ( $T_A$ ):	
PACKAGE TYPES D, F, K, H	-55 to $+125^\circ C$
PACKAGE TYPE E	-40 to $+85^\circ C$
STORAGE TEMPERATURE RANGE ( $T_{stg}$ )	-65 to $+150^\circ C$
LEAD TEMPERATURE (DURING SOLDERING):	
At distance $1/16 \pm 1/32$ inch ( $1.59 \pm 0.79$ mm) from case for 10 s max.	$+265^\circ C$

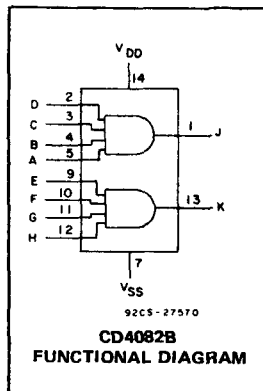

### RECOMMENDED OPERATING CONDITIONS

For maximum reliability, nominal operating conditions should be selected so that operation is always within the following ranges:

CHARACTERISTIC	LIMITS		UNITS
	MIN.	MAX.	
Supply-Voltage Range (For $T_A =$ Full Package Temperature Range)	3	18	V

DYNAMIC ELECTRICAL CHARACTERISTICS at  $T_A = 25^\circ C$ , Input  $t_r, t_f = 20$  ns, and  $C_L = 50$  pF,  $R_L = 200$  k $\Omega$

CHARACTERISTIC	TEST CONDITIONS	ALL TYPES LIMITS		UNITS	
		$V_{DD}$ Volts	TYP.		MAX.
Propagation Delay Time, $t_{PHL}, t_{PLH}$		5	125	250	ns
		10	60	120	
		15	45	90	
Transition Time, $t_{THL}, t_{TLH}$		5	100	200	ns
		10	50	100	
		15	40	80	
Input Capacitance, $C_{iN}$	Any Input	—	5	7.5	pF

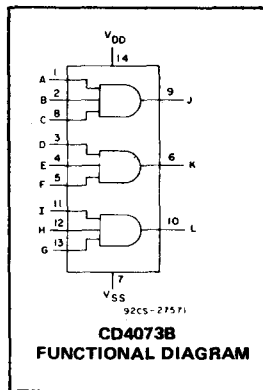

# CD4073B, CD4081B, CD4082B Types

## STATIC ELECTRICAL CHARACTERISTICS

CHARACTERISTIC	CONDITIONS			LIMITS AT INDICATED TEMPERATURES (°C)							UNITS
	V <sub>O</sub> (V)	V <sub>IN</sub> (V)	V <sub>DD</sub> (V)	+25							
				-55	-40	+85	+125	Min.	Typ.	Max.	
Quiescent Device Current, I <sub>DD</sub> Max.	—	0,5	5	0.25	0.25	7.5	7.5	—	0.01	0.25	μA
	—	0,10	10	0.5	0.5	15	15	—	0.01	0.5	
	—	0,15	15	1	1	30	30	—	0.01	1	
	—	0,20	20	5	5	150	150	—	0.02	5	
Output Low (Sink) Current I <sub>OL</sub> Min.	0.4	0,5	5	0.64	0.61	0.42	0.36	0.51	1	—	mA
	0.5	0,10	10	1.6	1.5	1.1	0.9	1.3	2.6	—	
	1.5	0,15	15	4.2	4	2.8	2.4	3.4	6.8	—	
	—	—	—	—	—	—	—	—	—	—	
Output High (Source) Current, I <sub>OH</sub> Min.	4.6	0,5	5	-0.64	-0.61	-0.42	-0.36	-0.51	-1	—	mA
	2.5	0,5	5	-2	-1.8	-1.3	-1.15	-1.6	-3.2	—	
	9.5	0,10	10	-1.6	-1.5	-1.1	-0.9	-1.3	-2.6	—	
	13.5	0,15	15	-4.2	-4	-2.8	-2.4	-3.4	-6.8	—	
Output Voltage: Low-Level, V <sub>OL</sub> Max.	—	0,5	5	0.05			—	0	0.05	—	V
	—	0,10	10	0.05			—	0	0.05	—	
	—	0,15	15	0.05			—	0	0.05	—	
Output Voltage: High-Level, V <sub>OH</sub> Min.	—	0,5	5	4.95			4.95	5	—	—	V
	—	0,10	10	9.95			9.95	10	—	—	
	—	0,15	15	14.95			14.95	15	—	—	
Input Low Voltage, V <sub>IL</sub> Max.	0.5	—	5	1.5			—	—	1.5	—	V
	1	—	10	3			—	—	3	—	
	1.5	—	15	4			—	—	4	—	
Input High Voltage, V <sub>IH</sub> Min.	0.5,4,5	—	5	3.5			3.5	—	—	—	V
	1,9	—	10	7			7	—	—	—	
	1.5,13.5	—	15	11			11	—	—	—	
Input Current I <sub>IN</sub> Max.		0,18	18	±0.1	±0.1	±1	±1	—	±10 <sup>-5</sup>	±0.1	μA

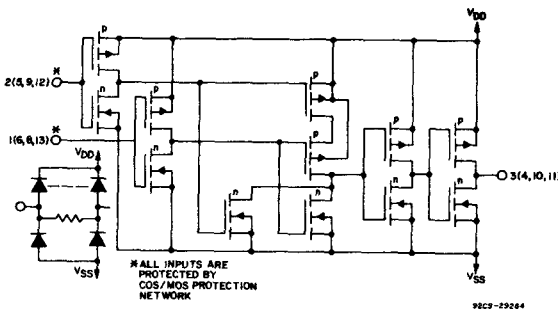

Fig. 1 - Schematic diagram for CD4081B (1 of 4 identical gates).

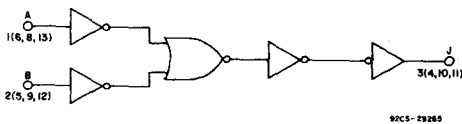

Fig. 2 - Logic diagram for CD4081B (1 of 4 identical gates).

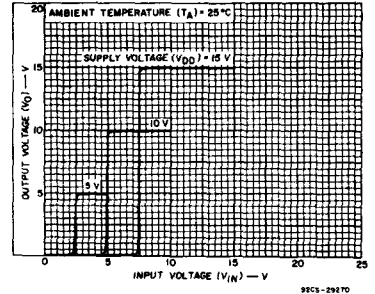

Fig. 3 - Typical voltage transfer characteristics.

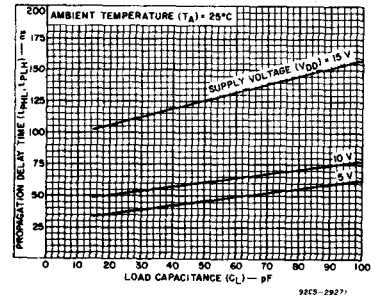

Fig. 4 - Typical propagation delay time as a function of load capacitance.

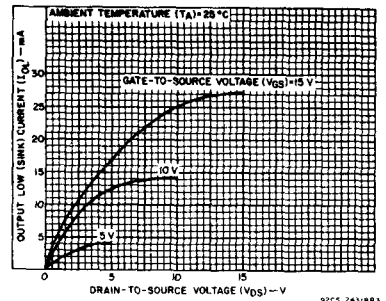

Fig. 5 - Typical output low (sink) current characteristics.

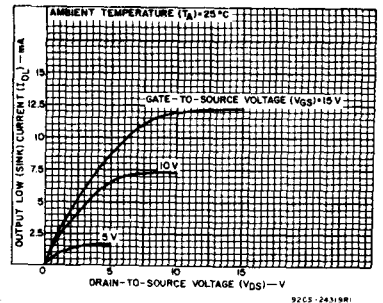

Fig. 6 - Minimum output low (sink) current characteristics.

# CD4073B, CD4081B, CD4082B Types

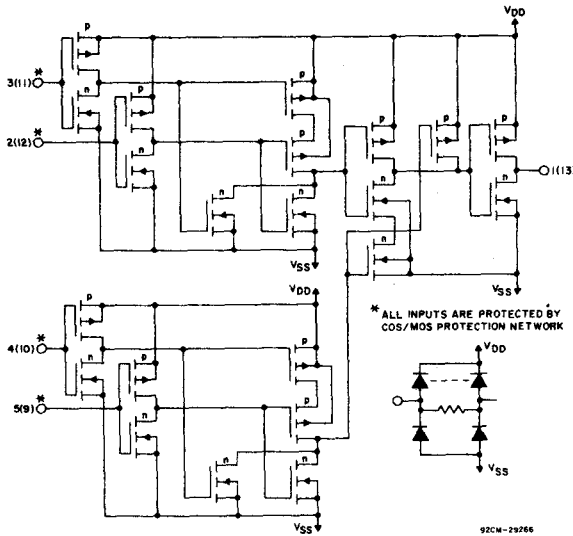

Fig. 7 - Schematic diagram for CD4082B (1 of 2 identical gates).

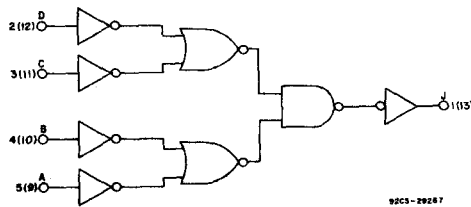

Fig. 9 - Logic diagram for CD4082B (1 of 2 identical gates).

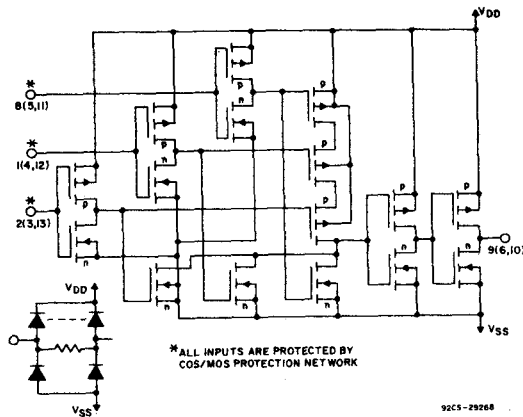

Fig. 11 - Schematic diagram for CD4073B (1 of 3 identical gates).

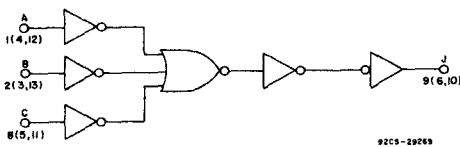

Fig. 13 - Logic diagram for CD4073B (1 of 3 identical gates).

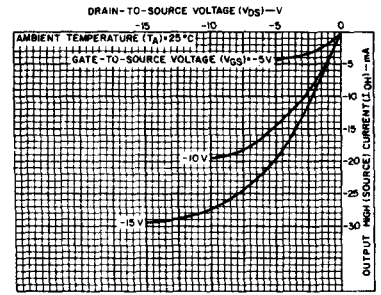

Fig. 8 - Typical output high (source) current characteristics.

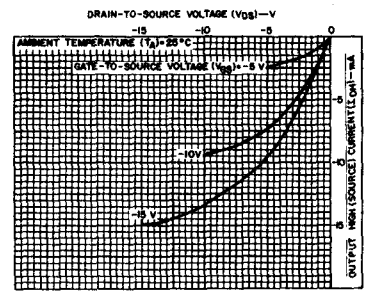

Fig. 10 - Minimum output high (source) current characteristics.

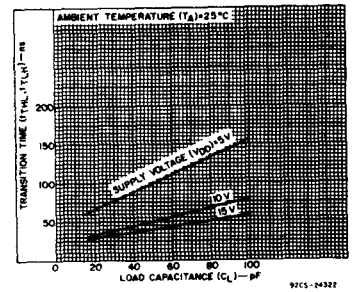

Fig. 12 - Typical transition time as a function of load capacitance.

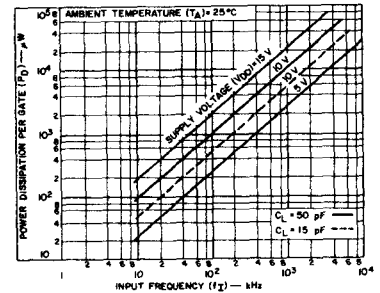

Fig. 14 - Typical dynamic power dissipation per gate as a function of frequency.

# CD4073B, CD4081B, CD4082B Types

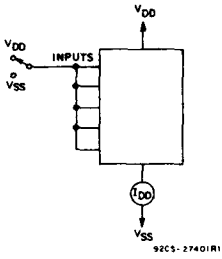

Fig. 15 - Quiescent device current test circuit.

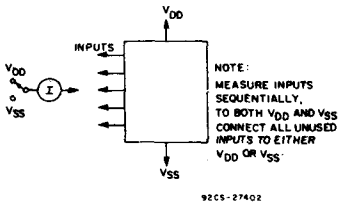

Fig. 16 - Input current test circuit.

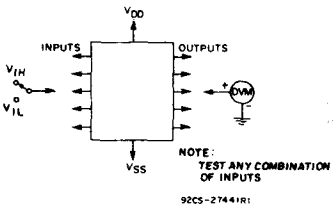
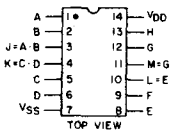

Fig. 17 - Input-voltage test circuit.

## TERMINAL ASSIGNMENTS



92CS-24536

### CD4081B

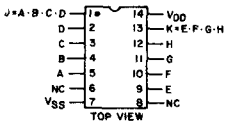

NC=NO CONNECTION

92CS-24937R2

### CD4082B

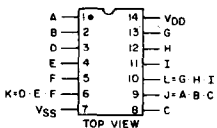

92CS-24538

### CD4073B

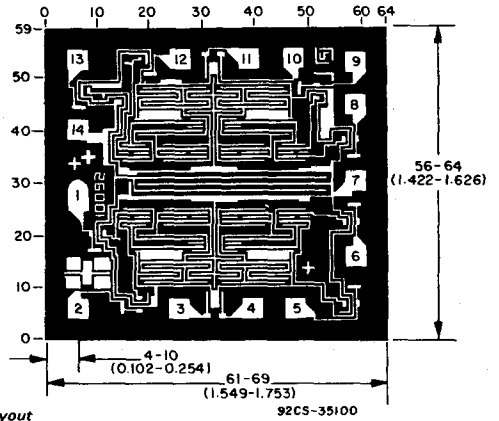

Dimensions and pad layout for CD4081B.

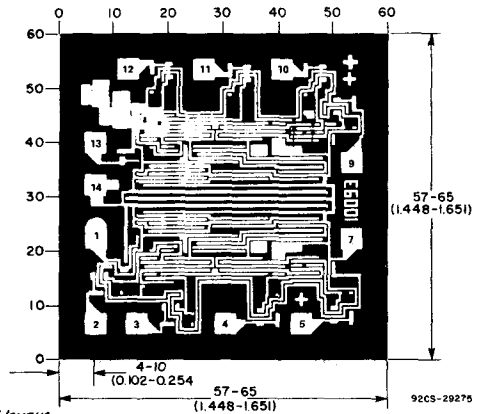

Dimensions and pad layout for CD4082B.

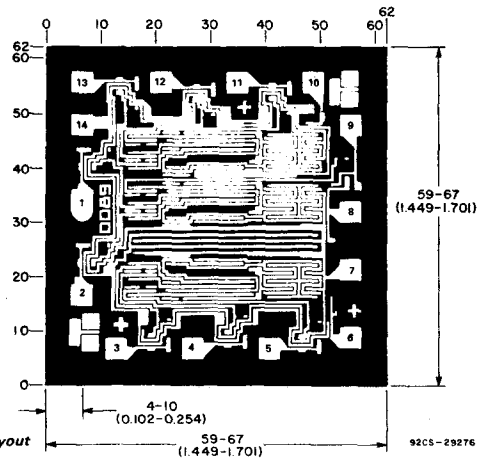

Dimensions and pad layout for CD4073B.

Dimensions in parentheses are in millimeters and are derived from the basic inch dimensions as indicated. Grid graduations are in mils ( $10^{-3}$  inch).

The photographs and dimensions of each CMOS chip represent a chip when it is part of the wafer. When the wafer is separated into individual chips, the angle of cleavage may vary with respect to the chip face for different chips. The actual dimensions of the isolated

chip, therefore, may differ slightly from the nominal dimensions shown. The user should consider a tolerance of  $-3$  mils to  $+16$  mils applicable to the nominal dimensions shown.

# CD4076B Types

## CMOS 4-Bit D-Type Registers

High-Voltage Types (20-Volt Rating)

The CD4076B types are four-bit registers consisting of D-type flip-flops that feature three-state outputs. Data Disable inputs are provided to control the entry of data into the flip-flops. When both Data Disable inputs are low, data at the D inputs are loaded into their respective flip-flops on the next positive transition of the clock input. Output Disable inputs are also provided. When the Output Disable inputs are both low, the normal logic states of the four outputs are available to the load. The outputs are disabled independently of the clock by a high logic level at either Output Disable input, and present a high impedance.

The CD4076B types are supplied in 16-lead ceramic dual-in-line packages (D and F suffixes), 16-lead dual-in-line plastic packages (E suffix), 16-lead ceramic flat packages (K suffix), and in chip form (H suffix).

### Features:

- Three-state outputs
- Input disabled without gating the clock
- Gated output control lines for enabling or disabling the outputs
- Standardized, symmetrical output characteristics
- 100% tested for quiescent current at 20 V
- Maximum input current of 1  $\mu$ A at 18 V over full package temperature range; 100 nA at 18 V and 25°C
- Noise margin over full package temperature range:

1 V at  $V_{DD} = 5$  V  
 2 V at  $V_{DD} = 10$  V  
 2.5 V at  $V_{DD} = 15$  V

- 5-V, 10-V, and 15-V parametric ratings
- Meets all requirements of JEDEC Tentative Standard No. 13A, "Standard Specifications for Description of 'B' Series CMOS Devices"

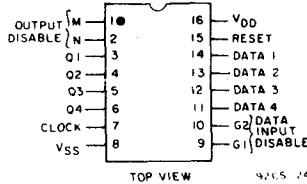

### TERMINAL ASSIGNMENT

**RECOMMENDED OPERATING CONDITIONS** at  $T_A = 25^\circ\text{C}$ , Except as Noted.  
 For maximum reliability, nominal operating conditions should be selected so that operation is always within the following ranges:

CHARACTERISTIC	$V_{DD}$ (V)	LIMITS		UNITS
		Min.	Max.	
Supply Voltage Range (For $T_A$ = Full Package Temperature Range)		3	18	V
Data Setup Time, $t_s$	5	200	—	ns
	10	80	—	
	15	60	—	
Clock Pulse Width, $t_W$	5	200	—	ns
	10	100	—	
	15	80	—	
Clock Input Frequency, $f_{CL}$	5	dc	3	MHz
	10	—	6	
	15	—	8	
Clock Input Rise or Fall Time, $t_{rCL}, t_{fCL}$	5	—	15	$\mu$ s
	10	—	5	
	15	—	5	
Reset Pulse Width, $t_W$	5	120	—	ns
	10	50	—	
	15	40	—	
Data Input Disable Setup Time, $t_s$	5	180	—	ns
	10	100	—	
	15	70	—	

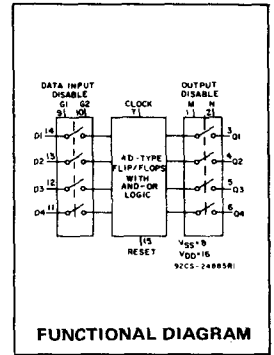

FUNCTIONAL DIAGRAM

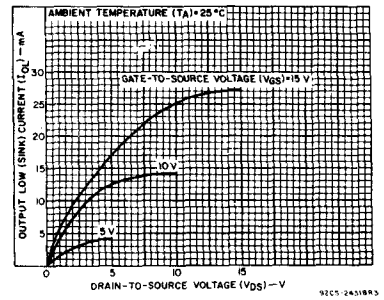

Fig. 1 — Typical output low (sink) current characteristics.

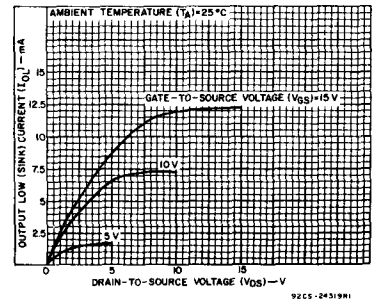

Fig. 2 — Minimum output low (sink) current characteristics.

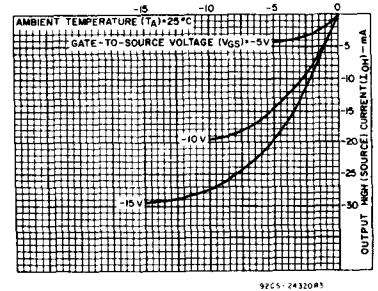

Fig. 3 — Typical output high (source) current characteristics.





# CD4076B Types

**DYNAMIC ELECTRICAL CHARACTERISTICS at  $T_A = 25^\circ\text{C}$ , Input  $t_r, t_f = 20 \text{ ns}$ ,  $C_L = 50 \text{ pF}$ ,  $R_L = 200 \text{ k}\Omega$  (Unless otherwise noted)**

CHARACTERISTIC	TEST CONDITIONS	LIMITS			UNITS	
		$V_{DD}$ V	Min.	Typ.		Max.
Propagation Delay Time: Clock to Q Output, $t_{PHL}$ , $t_{PLH}$		5		300	600	ns
		10		125	250	
		15		90	180	
Reset, $t_{PHL}$		5		230	460	
		10		100	200	
		15		75	150	
3-State Output 1 or 0 to High Impedance, $t_{PHZ}$ , $t_{PLZ}$	$R_L = 1 \text{ k}\Omega$	5		150	300	
		10		75	150	
		15		60	120	
3-State High Impedance to 1 or 0 Output, $t_{PZH}$ , $t_{PZL}$	$R_L = 1 \text{ k}\Omega$	5		150	300	
		10		75	150	
		15		60	120	
Transition Time, $t_{THL}$ , $t_{TLH}$		5		100	200	ns
		10		50	100	
		15		40	80	
Maximum Clock Input Frequency, $f_{CL}$		5	3	6		MHz
		10	6	12		
		15	8	16		
Minimum Clock Pulse Width, $t_W$		5		100	200	ns
		10		50	100	
		15		40	80	
Maximum Clock Input Rise or Fall Time, $t_{rcl}$ , $t_{fcl}$		5	15	—	—	$\mu\text{s}$
		10	5	—	—	
		15	5	—	—	
Minimum Reset Pulse Width, $t_W$		5		60	120	ns
		10		25	50	
		15		20	40	
Minimum Data Setup Time, $t_S$		5		100	200	ns
		10		40	80	
		15		30	60	
Minimum Data Input Disable Setup Time, $t_S$		5		90	180	ns
		10		50	100	
		15		35	70	
Input Capacitance, $C_{IN}$	Any Input	—	—	5	7.5	pF

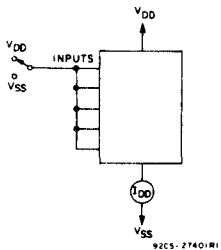

Fig. 11 - Quiescent device current test circuit.

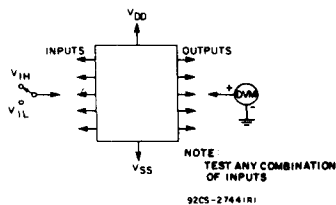

Fig. 12 - Input voltage test circuit.

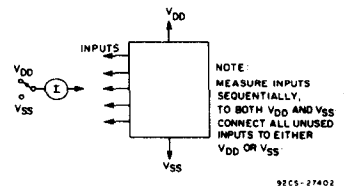

Fig. 13 - Input current test circuit.

# CD4076B Types

## STATIC ELECTRICAL CHARACTERISTICS.

CHARACTERISTIC	CONDITIONS			LIMITS AT INDICATED TEMPERATURES (°C)							UNITS
	V <sub>O</sub> (V)	V <sub>IIN</sub> (V)	V <sub>DD</sub> (V)	Values at -55, +25, +125 Apply to D, F, K, H Packages				Values at -40, +25, +85 Apply to E Package			
				-55	-40	+85	+125	+25			
				Min. Typ. Max.							
Quiescent Device Current, I <sub>DD</sub> Max.	-	0,5	5	5	5	150	150	-	0,04	5	μA
	-	0,10	10	10	10	300	300	-	0,04	10	
	-	0,15	15	20	20	600	600	-	0,04	20	
	-	0,20	20	100	100	3000	3000	-	0,08	100	
Output Low (Sink) Current I <sub>OL</sub> Min.	0,4	0,5	5	0,64	0,61	0,42	0,36	0,51	1	-	mA
	0,5	0,10	10	1,6	1,5	1,1	0,9	1,3	2,6	-	
	1,5	0,15	15	4,2	4	2,8	2,4	3,4	6,8	-	
Output High (Source) Current, I <sub>OH</sub> Min.	4,6	0,5	5	-0,64	-0,61	-0,42	-0,36	-0,51	-1	-	mA
	2,5	0,5	5	-2	-1,8	-1,3	-1,15	-1,6	-3,2	-	
	9,5	0,10	10	-1,6	-1,5	-1,1	-0,9	-1,3	-2,6	-	
Output Voltage: Low-Level, V <sub>OL</sub> Max.	-	0,5	5	0,05				-	0	0,05	V
	-	0,10	10	0,05				-	0	0,05	
	-	0,15	15	0,05				-	0	0,05	
Output Voltage: High-Level, V <sub>OH</sub> Min.	-	0,5	5	4,95				4,95	5	-	V
	-	0,10	10	9,95				9,95	10	-	
	-	0,15	15	14,95				14,95	15	-	
Input Low Voltage, V <sub>IL</sub> Max.	0,5, 4,5	-	5	1,5				-	-	1,5	V
	1, 9	-	10	3				-	-	3	
	1,5, 13,5	-	15	4				-	-	4	
Input High Voltage, V <sub>IH</sub> Min.	0,5, 4,5	-	5	3,5				3,5	-	-	V
	1, 9	-	10	7				7	-	-	
	1,5, 13,5	-	15	11				11	-	-	
Input Current I <sub>IIN</sub> Max.	-	0,18	18	±0,1	±0,1	±1	±1	-	±10 <sup>-5</sup>	±0,1	μA
3-State Output Leakage Current I <sub>OOUT</sub> Max.	0,18	0,18	18	±0,4	±0,4	±12	±12	-	±10 <sup>-4</sup>	±0,4	μA

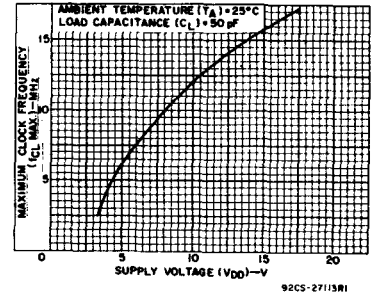

Fig.9 - Typical maximum clock input frequency vs. supply voltage.

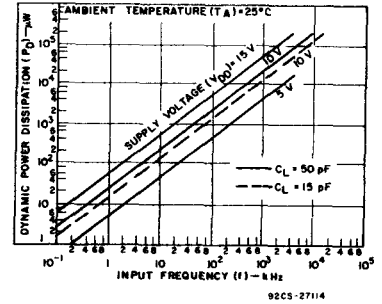
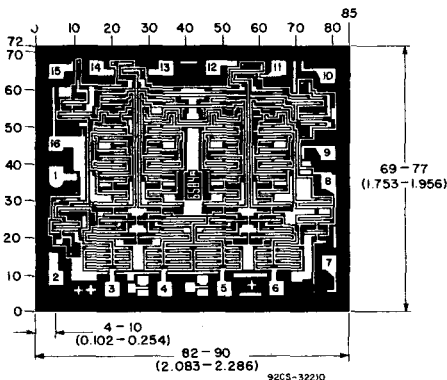

Fig.10 - Typical dynamic power dissipation vs. frequency.



### Dimensions and pad layout for CD4076BH

Dimensions in parentheses are in millimeters and are derived from the basic inch dimensions as indicated. Grid graduations are in mils (10<sup>-3</sup> inch).

The photographs and dimensions of each CMOS chip represent a chip when it is part of the wafer. When the wafer is separated into individual chips, the angle of cleavage may vary with respect to the chip face for different chips. The actual dimensions of the isolated chip, therefore, may differ slightly from the nominal dimensions shown. The user should consider a tolerance of -3 mils to +16 mils applicable to the nominal dimensions shown.

# CD4078B Types

## CMOS 8-Input NOR/OR Gate

High-Voltage Types (20-Volt Rating)

The RCA-CD4078B NOR/OR Gate provides the system designer with direct implementation of the positive-logic 8-input NOR and OR functions and supplements the existing family of CMOS gates.

The CD4078B types are supplied in 14-lead dual-in-line ceramic packages (D and F suffixes), 14-lead dual-in-line plastic packages (E suffix), 14-lead ceramic flat packages (K suffix), and in chip form (H suffix).

### Features:

- Medium-Speed Operation:  $t_{PHL}, t_{PLH} = 75 \text{ ns (typ.)}$  at  $V_{DD} = 10 \text{ V}$
- Buffered inputs and output
- 5-V, 10-V, and 15-V parametric ratings
- Standardized symmetrical output characteristics
- 100% tested for quiescent current at 20 V
- Maximum input current of  $1 \mu\text{A}$  at 18 V over full package-temperature range: 100 nA at 18 V and 25°C
- Noise margin (over full package-temperature range): 1 V at  $V_{DD} = 5 \text{ V}$   
2 V at  $V_{DD} = 10 \text{ V}$  2.5 V at  $V_{DD} = 15 \text{ V}$
- Meets all requirements of JEDEC Tentative Standard No. 13A, "Standard Specifications for Description of 'B' Series CMOS Devices"

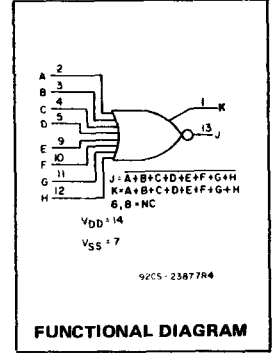

### MAXIMUM RATINGS, Absolute-Maximum Values:

DC SUPPLY-VOLTAGE RANGE, ( $V_{DD}$ ) (Voltages referenced to $V_{SS}$ Terminal)	-0.5 to +20 V
INPUT VOLTAGE RANGE, ALL INPUTS	-0.5 to $V_{DD} + 0.5 \text{ V}$
DC INPUT CURRENT, ANY ONE INPUT	$\pm 10 \text{ mA}$
POWER DISSIPATION PER PACKAGE ( $P_D$ ):	
For $T_A = -40$ to $+60^\circ\text{C}$ (PACKAGE TYPE E)	500 mW
For $T_A = +60$ to $+85^\circ\text{C}$ (PACKAGE TYPE E)	Derate Linearly at 12 mW/ $^\circ\text{C}$ to 200 mW
For $T_A = -55$ to $+100^\circ\text{C}$ (PACKAGE TYPES D, F, K)	500 mW
For $T_A = +100$ to $+125^\circ\text{C}$ (PACKAGE TYPES D, F, K)	Derate Linearly at 12 mW/ $^\circ\text{C}$ to 200 mW
DEVICE DISSIPATION PER OUTPUT TRANSISTOR FOR $T_A = \text{FULL PACKAGE-TEMPERATURE RANGE (All Package Types)}$	100 mW
OPERATING-TEMPERATURE RANGE ( $T_A$ ):	
PACKAGE TYPES D, F, K, H	-55 to $+125^\circ\text{C}$
PACKAGE TYPE E	-40 to $+85^\circ\text{C}$
STORAGE TEMPERATURE RANGE ( $T_{stg}$ )	-65 to $+150^\circ\text{C}$
LEAD TEMPERATURE (DURING SOLDERING):	
At distance $1/16 \pm 1/32$ inch ( $1.59 \pm 0.79 \text{ mm}$ ) from case for 10 s max.	$+265^\circ\text{C}$

### RECOMMENDED OPERATING CONDITIONS

For maximum reliability, nominal operating conditions should be selected so that operation is always within the following ranges:

CHARACTERISTIC	Min.	Max.	Units
Supply Voltage Range (For $T_A$ Full Package Temperature Range)	3	18	V

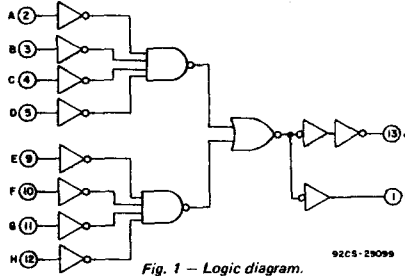

### DYNAMIC ELECTRICAL CHARACTERISTICS

At  $T_A = 25^\circ\text{C}$ ; Input  $t_r, t_f = 20 \text{ ns}$ ,  $C_L = 50 \text{ pF}$ ,  $R_L = 200k\Omega$

CHARACTERISTIC	TEST CONDITIONS	ALL TYPES LIMITS		UNITS	
		$V_{DD}$ VOLTS	TYP.		MAX.
Propagation Delay Time, $t_{PHL}, t_{PLH}$		5	150	300	ns
		10	75	150	
		15	55	110	
Transition Time, $t_{THL}, t_{TLH}$		5	100	200	ns
		10	50	100	
		15	40	80	
Input Capacitance, $C_{IN}$	Any Input	5	7.5	pF	

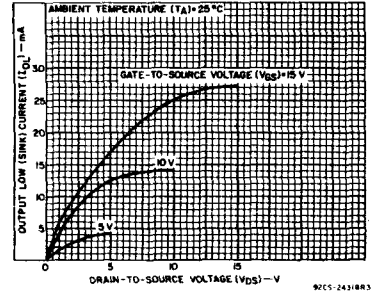

Fig. 2 - Typical output low (sink) current characteristics.

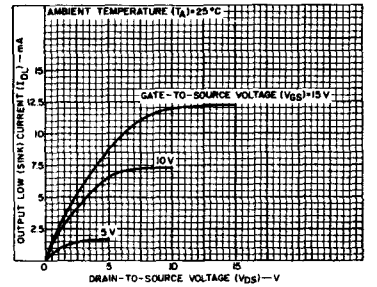

Fig. 3 - Minimum output low (sink) current characteristics.

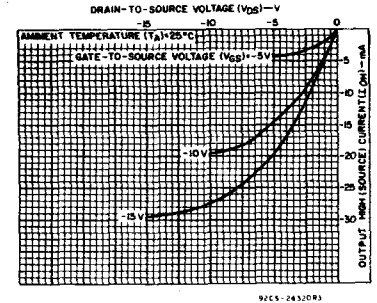

Fig. 4 - Typical output high (source) current characteristics.

# CD4078B Types

## STATIC ELECTRICAL CHARACTERISTICS

CHARACTERISTIC	CONDITIONS			LIMITS AT INDICATED TEMPERATURES (°C)							UNITS	
	V <sub>O</sub> (V)	V <sub>IN</sub> (V)	V <sub>DD</sub> (V)	Values at -55, +25, +125 Apply to D, F, K, H Packages				Values at -40, +25, +85 Apply to E Package				
				-55	-40	+85	+125	+25				
								Min.	Typ.	Max.		
Quiescent Device Current, I <sub>DD</sub> Max.	-	0,5	5	0,25	0,25	7,5	7,5	-	0,01	0,25	μA	
	-	0,10	10	0,5	0,5	15	15	-	0,01	0,5		
	-	0,15	15	1	1	30	30	-	0,01	1		
	-	0,20	20	5	5	150	150	-	0,02	5		
Output Low (Sink) Current, I <sub>OL</sub> Min.	0,4	0,5	5	0,64	0,61	0,42	0,36	0,51	1	mA		
	0,5	0,10	10	1,6	1,5	1,1	0,9	1,3	2,6			
	1,5	0,15	15	4,2	4	2,8	2,4	3,4	6,8			
Output High (Source) Current, I <sub>OH</sub> Min.	4,6	0,5	5	-0,64	-0,61	-0,42	-0,36	-0,51	-1	mA		
	2,5	0,5	5	-2	-1,8	-1,3	-1,15	-1,6	-3,2			
	9,5	0,10	10	-1,6	-1,5	-1,1	-0,9	-1,3	-2,6			
	13,5	0,15	15	-4,2	-4	-2,8	-2,4	-3,4	-6,8			
Output Voltage Low-Level, V <sub>OL</sub> Max.	-	0,5	5	0,05				0			V	
	-	0,10	10	0,05				0				
	-	0,15	15	0,05				0				
Output Voltage High-Level, V <sub>OH</sub> Min.	-	0,5	5	4,95				4,95			V	
	-	0,10	10	9,95				9,95				
	-	0,15	15	14,95				14,95				
	-	0,15	15	14,95				15				
Input Low Voltage, V <sub>IL</sub> Max.	0,5,4,5	-	5	1,5				-			V	
	1,9	-	10	3				-				
	1,5,13,5	-	15	4				-				
Input High Voltage, V <sub>IH</sub> Min.	0,5,4,5	-	5	3,5				3,5			V	
	1,9	-	10	7				7				
	1,5,13,5	-	15	11				11				
Input Current I <sub>IN</sub> Max.			0,18	18	±0,1	±0,1	±1	±1	-	±10 <sup>-5</sup>	±0,1	μA

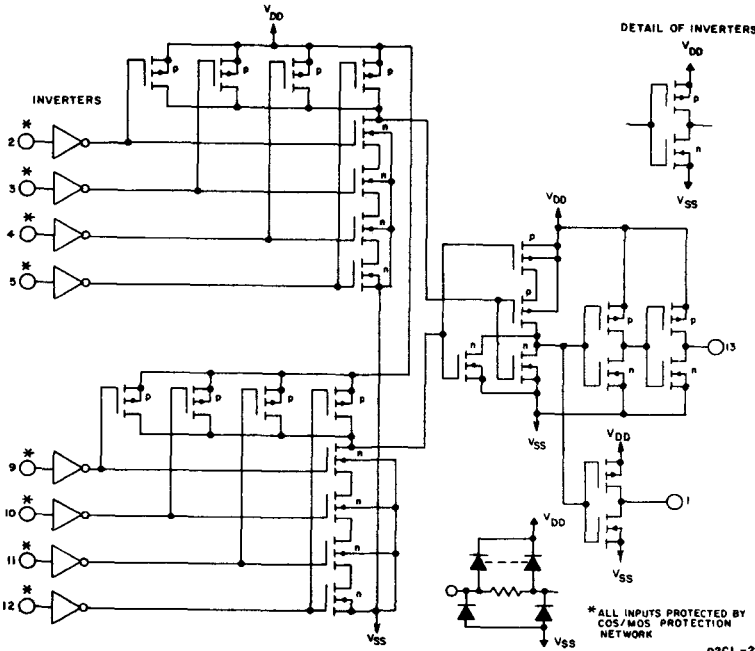

Fig. 8 - Schematic diagram.

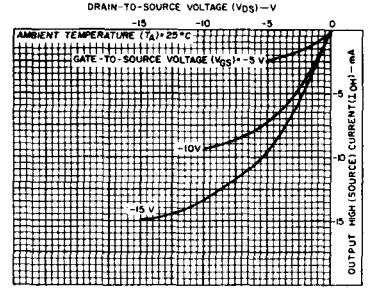

Fig. 5 - Minimum output high (source) current characteristics.

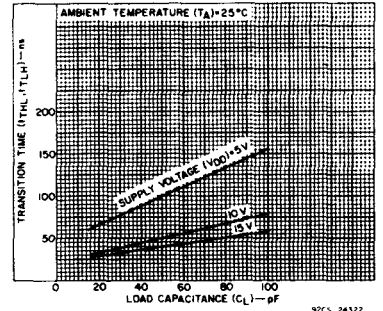

Fig. 6 - Typical transition time as a function of load capacitance.

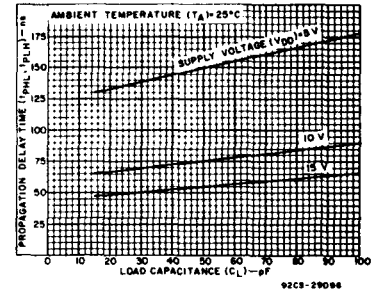

Fig. 7 - Typical propagation delay time as a function of load capacitance.

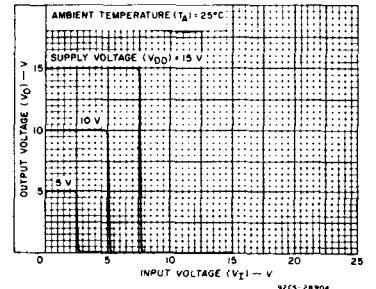

Fig. 9 - Typical voltage transfer characteristics (NOR output).

# CD4078B Types

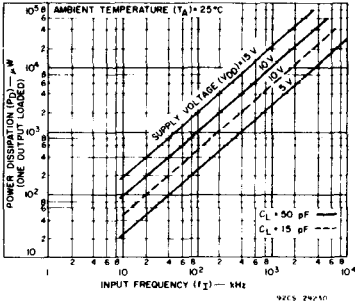

Fig. 10 - Typical dynamic power dissipation as a function of frequency.

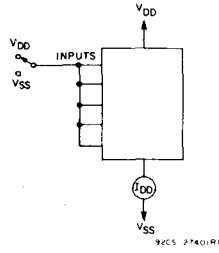

Fig. 11 - Quiescent device current test circuit.

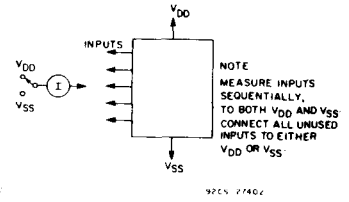

Fig. 12 - Input current test circuit.

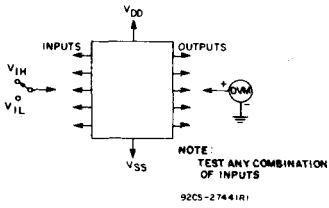

Fig. 13 - Input voltage test circuit.

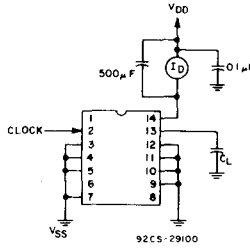
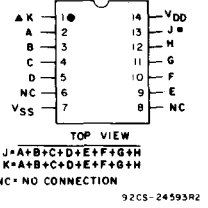
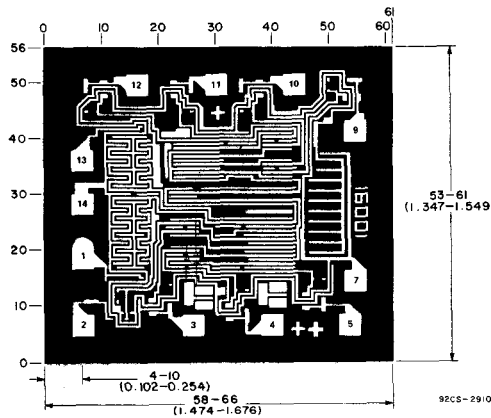

Fig. 14 - Dynamic power dissipation test circuit.



TERMINAL ASSIGNMENT



Dimensions and pad layout for CD4078BH.

Dimensions in parentheses are in millimeters and are derived from the basic inch dimensions as indicated. Grid graduations are in mils ( $10^{-3}$  inch).

The photographs and dimensions of each CMOS chip represent a chip when it is part of the wafer. When the wafer is separated into individual chips, the angle of cleavage may vary with respect to the chip face for different chips. The actual dimensions of the isolated chip, therefore, may differ slightly from the nominal dimensions shown. The user should consider a tolerance of  $-3$  mils to  $+16$  mils applicable to the nominal dimensions shown.

# CMOS Dual 2-Wide 2-Input AND-OR-INVERT Gate

High-Voltage Types (20-Volt Rating)

The RCA-CD4085 contains a pair of AND-OR-INVERT gates, each consisting of two 2-input AND gates driving a 3-input NOR gate. Individual inhibit controls are provided for both A-O-I gates.

The CD4085B types are supplied in 14-lead dual-in-line ceramic packages (D and F suffixes), 14-lead dual-in-line plastic packages (E suffix), 14-lead ceramic flat packages (K suffix), and in chip form (H suffix).

**Features:**

- Medium-speed operation —  $t_{PH} = 90$  ns;  $t_{PL} = 125$  ns (typ.) at 10 V
- Individual inhibit controls
- Standardized symmetrical output characteristics
- 100% tested for quiescent current at 20 V
- Maximum input current of 1  $\mu$ A at 18 V over full package temperature range; 100 nA at 18 V and 25°C
- Noise margin (over full package-temperature range):
  - 1 V at  $V_{DD} = 5$  V
  - 2 V at  $V_{DD} = 10$  V
  - 2.5 V at  $V_{DD} = 15$  V
- 5-V, 10-V, and 15-V parametric ratings
- Meets all requirements of JEDEC Tentative Standard No. 13A, "Standard Specifications for Description of 'B' Series CMOS Devices"

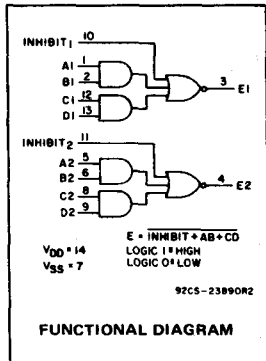

**MAXIMUM RATINGS, Absolute-Maximum Values:**

DC SUPPLY-VOLTAGE RANGE, ( $V_{DD}$ ) (Voltages referenced to $V_{SS}$ Terminal)	-0.5 to +20 V
INPUT VOLTAGE RANGE, ALL INPUTS	-0.5 to $V_{DD} + 0.5$ V
DC INPUT CURRENT, ANY ONE INPUT	$\pm 10$ mA
POWER DISSIPATION PER PACKAGE ( $P_D$ ):	
For $T_A = -40$ to $+60^\circ\text{C}$ (PACKAGE TYPE E)	500 mW
For $T_A = +60$ to $+85^\circ\text{C}$ (PACKAGE TYPE E)	Derate Linearly at 12 mW/ $^\circ\text{C}$ to 200 mW
For $T_A = -55$ to $+100^\circ\text{C}$ (PACKAGE TYPES D, F, K)	500 mW
For $T_A = +100$ to $+125^\circ\text{C}$ (PACKAGE TYPES D, F, K)	Derate Linearly at 12 mW/ $^\circ\text{C}$ to 200 mW
DEVICE DISSIPATION PER OUTPUT TRANSISTOR FOR $T_A =$ FULL PACKAGE-TEMPERATURE RANGE (All Package Types)	100 mW
OPERATING-TEMPERATURE RANGE ( $T_A$ ):	
PACKAGE TYPES D, F, K, H	$-55$ to $+125^\circ\text{C}$
PACKAGE TYPE E	$-40$ to $+85^\circ\text{C}$
STORAGE TEMPERATURE RANGE ( $T_{stg}$ )	$-65$ to $+150^\circ\text{C}$
LEAD TEMPERATURE (DURING SOLDERING):	
At distance 1/16 $\pm$ 1/32 inch (1.59 $\pm$ 0.79 mm) from case for 10 s max.	$+265^\circ\text{C}$

**RECOMMENDED OPERATING CONDITIONS**

For maximum reliability, nominal operating conditions should be selected so that operation is always within the following ranges:

CHARACTERISTIC	LIMITS		UNITS
	Min.	Max.	
Supply-Voltage Range (For $T_A$ =Full Package-Temperature Range)	3	18	V

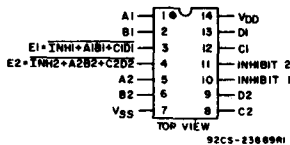

Terminal Assignment

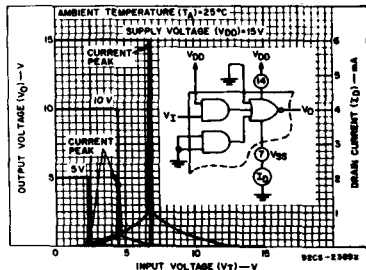

Fig. 1 — Typical voltage and current transfer characteristics.

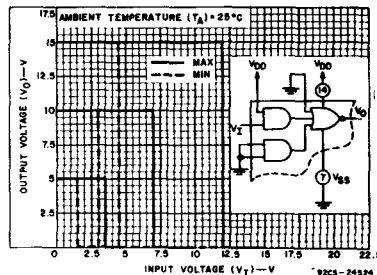

Fig. 2 — Min. and max. voltage transfer characteristics.

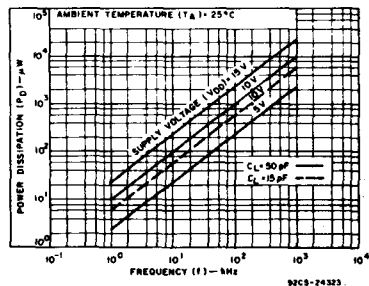

Fig. 3 — Typical power dissipation vs. frequency.

# CD4085B Types

## STATIC ELECTRICAL CHARACTERISTICS

CHARACTERISTIC	CONDITIONS			LIMITS AT INDICATED TEMPERATURES (°C)							UNITS
	V <sub>O</sub> (V)	V <sub>IN</sub> (V)	V <sub>DD</sub> (V)	Values at -55, +25, +125 Apply to D, F, K, H Pkgs.				Values at -40, +25, +85 Apply to E Pkgs.			
				-55	-40	+85	+125	+25			
								Min.	Typ.	Max.	
Quiescent Device Current I <sub>DD</sub> Max.	-	0,5	5	1	1	30	30	-	0.02	1	μA
	-	0,10	10	2	2	60	60	-	0.02	2	
	-	0,15	15	4	4	120	120	-	0.02	4	
	-	0,20	20	20	20	600	600	-	0.04	20	
Output Low (Sink) Current, I <sub>OL</sub> Min.	0.4	0,5	5	0.64	0.61	0.42	0.36	0.51	1	-	mA
	0.5	0,10	10	1.6	1.5	1.1	0.9	1.3	2.6	-	
	1.5	0,15	15	4.2	4	2.8	2.4	3.4	6.8	-	
	4.6	0,5	5	-0.64	-0.61	-0.42	-0.36	-0.51	-1	-	
	2.5	0,5	5	-2	-1.8	-1.3	-1.15	-1.6	-3.2	-	
	9.5	0,10	10	-1.6	-1.5	-1.1	-0.9	-1.3	-2.6	-	
Output High (Source) Current, I <sub>OH</sub> Min.	13.5	0,15	15	-4.2	-4	-2.8	-2.4	-3.4	-6.8	-	mA
	-	0,5	5								
	-	0,10	10								
Output Voltage: Low-Level, V <sub>OL</sub> Max.	-	0,5	5			0.05			0	0.05	V
	-	0,10	10			0.05			0	0.05	
	-	0,15	15			0.05			0	0.05	
Output Voltage: High-Level, V <sub>OH</sub> Min.	-	0,5	5			4.95		4.95	5	-	V
	-	0,10	10			9.95		9.95	10	-	
	-	0,15	15			14.95		14.95	15	-	
Input Low Voltage, V <sub>IL</sub> Max.	0.5, 4.5	-	5			1.5		-	-	1.5	V
	1.9	-	10			3		-	-	3	
	1.5, 13.5	-	15			4		-	-	4	
Input High Voltage, V <sub>IH</sub> Min.	0.5, 4.5	-	5			3.5		3.5	-	-	V
	1.9	-	10			7		7	-	-	
	1.5, 13.5	-	15			11		11	-	-	
Input Current, I <sub>IN</sub> Max.	-	0,18	18	±0.1	±0.1	±1	±1	-	±10 <sup>-5</sup>	±0.1	μA

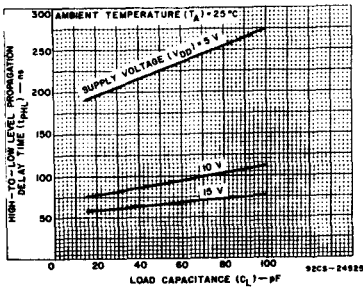

Fig. 4 - Typical data high-to-low level propagation delay time vs. load capacitance.

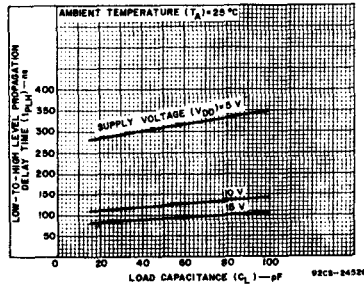

Fig. 5 - Typical data low-to-high level propagation delay time vs. load capacitance.

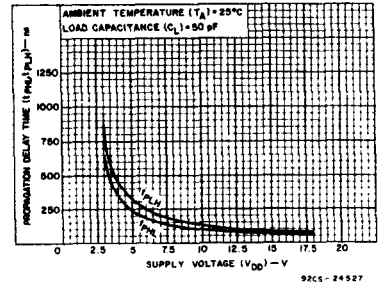

Fig. 6 - Typical data propagation delay time vs. supply voltage.



# CD405B Types

DYNAMIC ELECTRICAL CHARACTERISTICS at  $T_A = 25^\circ\text{C}$ ; Input  $t_r, t_f = 20\text{ ns}$ ,  
 $C_L = 50\text{ pF}$ ,  $R_L = 200\text{ k}\Omega$

CHARACTERISTIC	CONDITIONS	LIMITS		UNITS	
		$V_{DD}$ V	Typ.		Max.
Propagation Delay Time (Data): High-to-Low Level, $t_{PHL}$		5	225	450	ns
		10	90	180	
		15	65	130	
Propagation Delay Time (Data): Low-to-High Level, $t_{PLH}$		5	310	620	ns
		10	125	250	
		15	90	180	
Propagation Delay Time (Inhibit): High-to-Low Level, $t_{PHL}$		5	150	300	ns
		10	60	120	
		15	40	80	
Propagation Delay Time (Inhibit): Low-to-High Level, $t_{PLH}$		5	250	500	ns
		10	100	200	
		15	70	140	
Transition Time, $t_{THL}, t_{TLH}$		5	100	200	ns
		10	50	100	
		15	40	80	
Input Capacitance, $C_{IN}$	Any Input	5	7.5	pF	

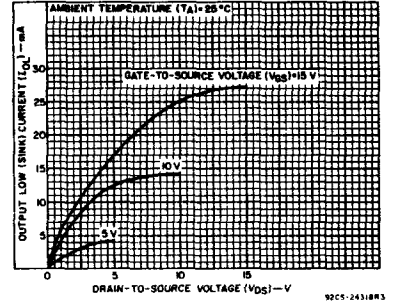

Fig. 7 - Typical output low (sink) current characteristics.

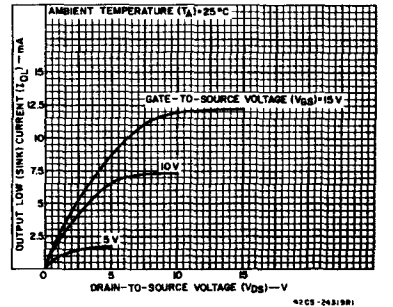

Fig. 8 - Minimum output low (sink) current characteristics.

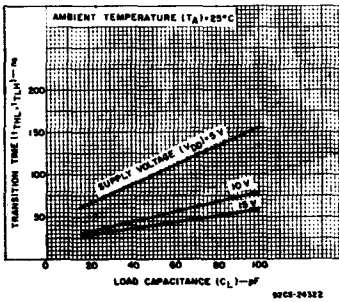

Fig. 9 - Typical transition time vs. load capacitance.

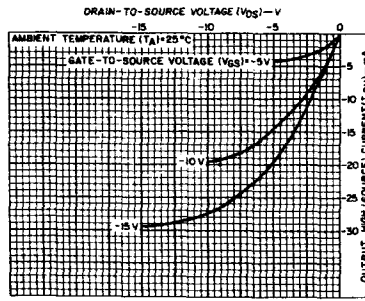

Fig. 10 - Typical output high (source) current characteristics.

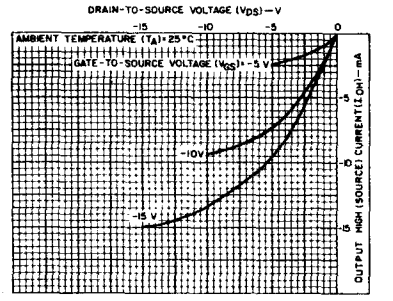

Fig. 11 - Minimum output high (source) current characteristics.

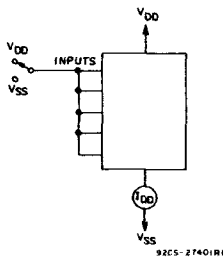

Fig. 12 - Quiescent device current test circuit.

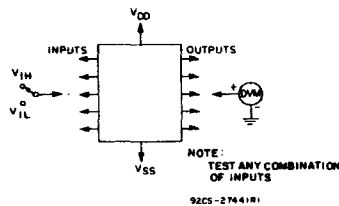

Fig. 13 - Input voltage test circuit.

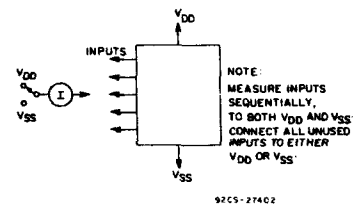

Fig. 14 - Input current test circuit.

# CD4085B Types

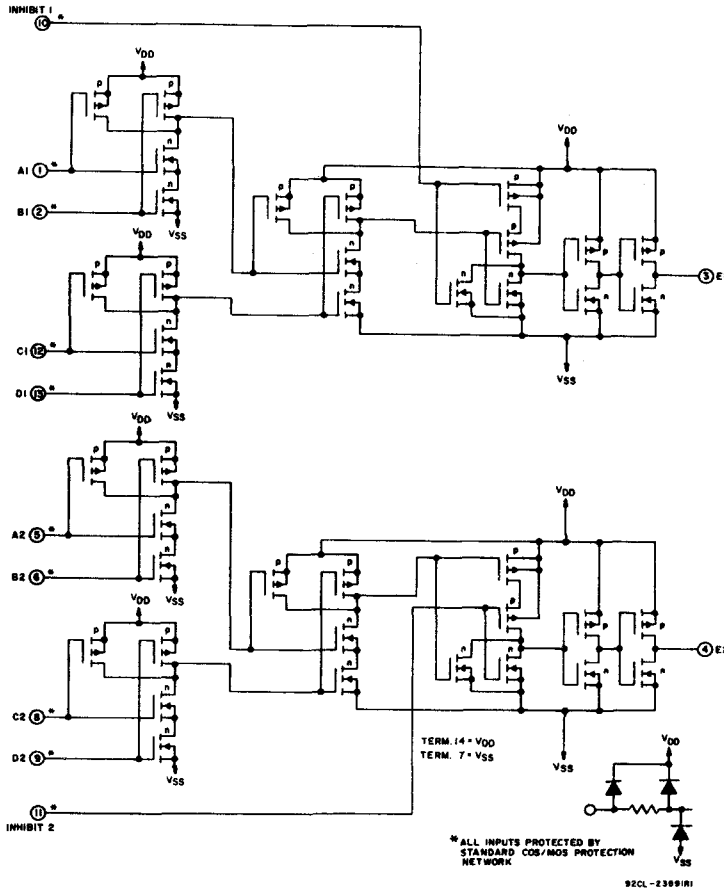
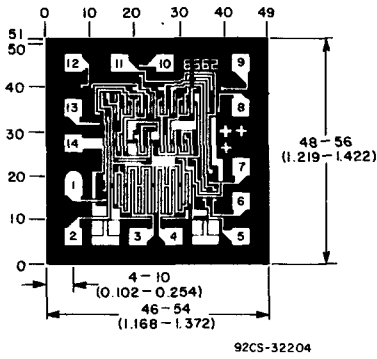

Fig. 15 - CD4085 schematic diagram.



Dimensions in parentheses are in millimeters and are derived from the basic inch dimensions as indicated. Grid graduations are in mils ( $10^{-3}$  inch).

The photographs and dimensions of each CMOS chip represent a chip when it is part of the wafer. When the wafer is separated into individual chips, the angle of cleavage may vary with respect to the chip face for different chips. The actual dimensions of the isolated chip, therefore, may differ slightly from the nominal dimensions shown. The user should consider a tolerance of  $-3$  mils to  $+16$  mils applicable to the nominal dimensions shown.

Dimensions and Pad Layout for CD4085BH.

# CMOS Expandable 4-Wide 2-Input AND-OR-INVERT Gate

High-Voltage Types (20-Volt Rating)

The RCA-CD4086B contains one 4-wide 2-input AND-OR-INVERT gate with an INHIBIT/EXP input and an ENABLE/EXP input. For a 4-wide A-O-I function INHIBIT/EXP is tied to  $V_{SS}$  and ENABLE/EXP to  $V_{DD}$ . See Fig.10 and its associated explanation for applications where a capability greater than 4-wide is required.

The CD4086B is supplied in 14-lead dual-in-line ceramic packages (D and F suffixes), 14-lead dual-in-line plastic packages (E suffix), 14-lead ceramic flat packages (K suffix), and in chip form (H suffix).

**Features:**

- Medium-speed operation —  $t_{PHL} = 90$  ns;  $t_{PLH} = 140$  ns (typ.) at 10 V
- INHIBIT and ENABLE inputs
- Buffered outputs
- 100% tested for quiescent current at 20 V
- Maximum input leakage current of 18 V over full package-temperature range; 100 nA at 18 V and 25°C
- Noise margin (over full package temperature range):
  - 1 V at  $V_{DD} = 5$  V
  - 2 V at  $V_{DD} = 10$  V
  - 2.5 V at  $V_{DD} = 15$  V
- Standardized, symmetrical output characteristics
- 5-V, 10-V, and 15-V parametric ratings
- Meets all requirements of JEDEC Tentative Standard No. 13A, "Standard Specifications for Description of 'B' Series CMOS Devices"

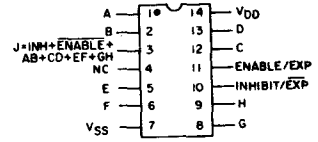
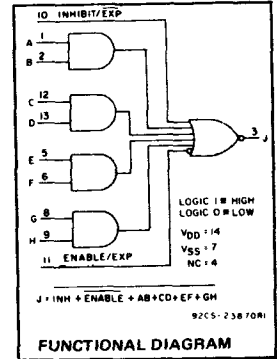

Top View  
TERMINAL ASSIGNMENT

**MAXIMUM RATINGS, Absolute-Maximum Values:**

DC SUPPLY-VOLTAGE RANGE, ( $V_{DD}$ )	-0.5 to +20 V
(Voltages referenced to $V_{SS}$ Terminal)	
INPUT VOLTAGE RANGE, ALL INPUTS	-0.5 to $V_{DD} + 0.5$ V
DC INPUT CURRENT, ANY ONE INPUT	$\pm 10$ mA
POWER DISSIPATION PER PACKAGE ( $P_D$ ):	
For $T_A = -40$ to $+80^\circ\text{C}$ (PACKAGE TYPE E)	500 mW
For $T_A = +80$ to $+85^\circ\text{C}$ (PACKAGE TYPE E)	Derate Linearly at 12 mW/ $^\circ\text{C}$ to 200 mW
For $T_A = -55$ to $+100^\circ\text{C}$ (PACKAGE TYPES D, F, K)	500 mW
For $T_A = +100$ to $+125^\circ\text{C}$ (PACKAGE TYPES D, F, K)	Derate Linearly at 12 mW/ $^\circ\text{C}$ to 200 mW
DEVICE DISSIPATION PER OUTPUT TRANSISTOR	
FOR $T_A =$ FULL PACKAGE-TEMPERATURE RANGE (All Package Types)	100 mW
OPERATING-TEMPERATURE RANGE ( $T_A$ ):	
PACKAGE TYPES D, F, K, H	-55 to $+125^\circ\text{C}$
PACKAGE TYPE E	-40 to $+85^\circ\text{C}$
STORAGE TEMPERATURE RANGE ( $T_{STG}$ )	-65 to $+150^\circ\text{C}$
LEAD TEMPERATURE (DURING SOLDERING):	
At distance 1/16 $\pm$ 1/32 inch (1.69 $\pm$ 0.79 mm) from case for 10 s max.	$+265^\circ\text{C}$

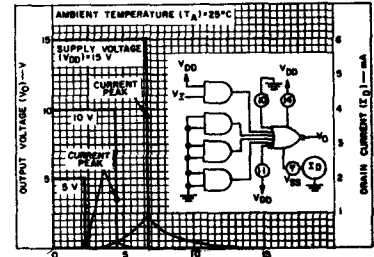

Fig. 1 — Typical voltage and current transfer characteristics.

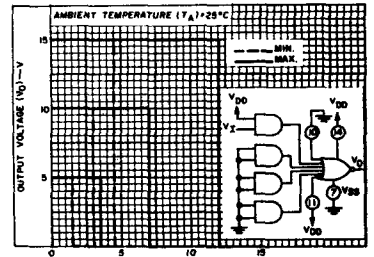

Fig. 2 — Minimum and maximum voltage transfer characteristics.

**RECOMMENDED OPERATING CONDITIONS**

For maximum reliability, nominal operating conditions should be selected so that operation is always within the following ranges:

CHARACTERISTIC	LIMITS		UNITS
	MIN.	MAX.	
Supply-Voltage Range (For $T_A =$ Full Package-Temperature Range)	3	18	V

# CD4086B Types

## STATIC ELECTRICAL CHARACTERISTICS

CHARACTERISTIC	CONDITIONS			LIMITS AT INDICATED TEMPERATURES (°C)							UNITS
	V <sub>O</sub> (V)	V <sub>IN</sub> (V)	V <sub>DD</sub> (V)	Values at -55, +25, +125 Apply to D, F, K, H Pkgs.				Values at -40, +25, +85 Apply to E Pkgs.			
				-55	-40	+85	+125	+25			
								Min.	Typ.	Max.	
Quiescent Device Current I <sub>DD</sub> Max.	-	0.5	5	1	1	30	30	-	0.02	1	μA
	-	0.10	10	2	2	60	60	-	0.02	2	
	-	0.15	15	4	4	120	120	-	0.02	4	
Output Low (Sink) Current, I <sub>OL</sub> Min.	0.4	0.5	5	0.64	0.61	0.42	0.36	0.51	1	-	mA
	0.5	0.10	10	1.6	1.5	1.1	0.9	1.3	2.6	-	
	1.5	0.15	15	4.2	4	2.8	2.4	3.4	6.8	-	
Output High (Source) Current, I <sub>OH</sub> Min.	4.6	0.5	5	-0.64	-0.61	-0.42	-0.36	-0.51	-1	-	mA
	2.5	0.5	5	-2	-1.8	-1.3	-1.15	-1.6	-3.2	-	
	9.5	0.10	10	-1.6	-1.5	-1.1	-0.9	-1.3	-2.6	-	
Output Voltage: Low-Level, V <sub>OL</sub> Max.	-	0.5	5			0.05			0	0.05	V
	-	0.10	10			0.05			0	0.05	
	-	0.15	15			0.05			0	0.05	
Output Voltage: High-Level, V <sub>OH</sub> Min.	-	0.5	5			4.95		4.95	5	-	V
	-	0.10	10			9.95		9.95	10	-	
	-	0.15	15			14.95		14.95	15	-	
Input Low Voltage, V <sub>IL</sub> Max.	0.5, 4.5	-	5			1.5		-	-	1.5	V
	1.9	-	10			3		-	-	3	
Input High Voltage, V <sub>IH</sub> Min.	0.5, 4.5	-	5			3.5		3.5	-	-	V
	1.9	-	10			7		7	-	-	
Input Current, I <sub>IN</sub> Max.	-	0.18	18	±0.1	±0.1	±1	±1	-	±10 <sup>-5</sup>	±0.1	μA

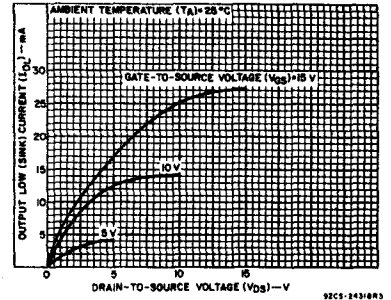

Fig. 3 - Typical output low (sink) current characteristics.

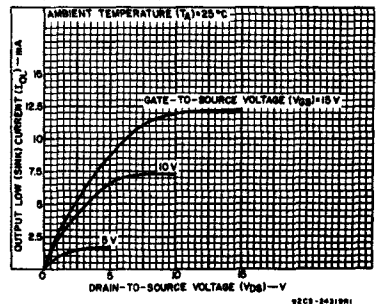

Fig. 4 - Minimum output low (sink) current characteristics.

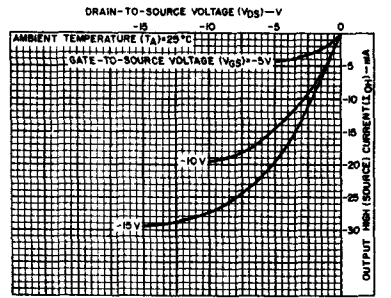

Fig. 5 - Typical output high (source) current characteristics.

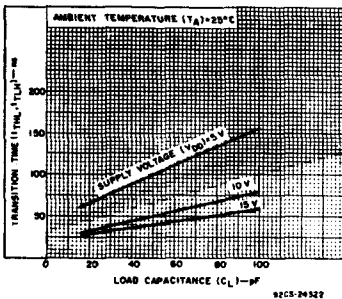

Fig. 6 - Typical transition time vs. load capacitance.

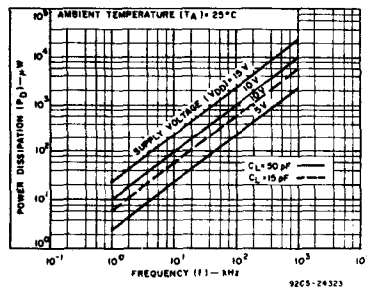

Fig. 7 - Typical power dissipation vs. frequency.

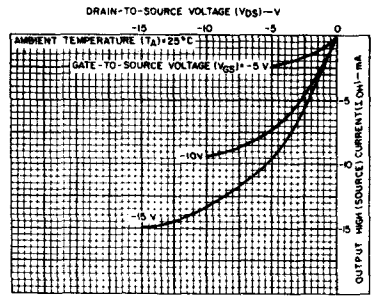

Fig. 8 - Minimum output high (source) current characteristics.

# CD4086B Types

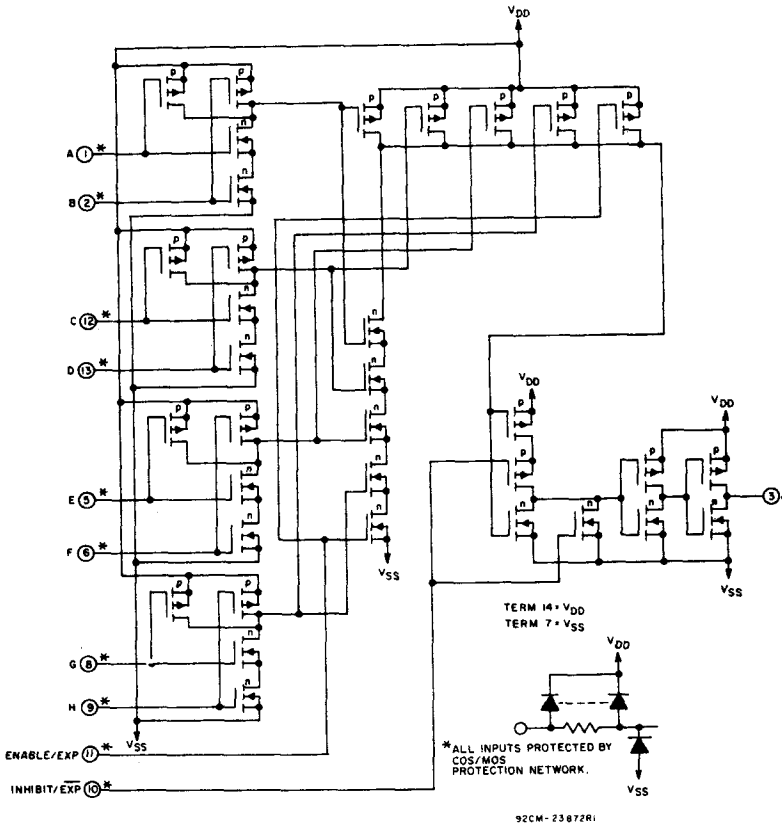

Fig. 9 - CD4086B schematic diagram.

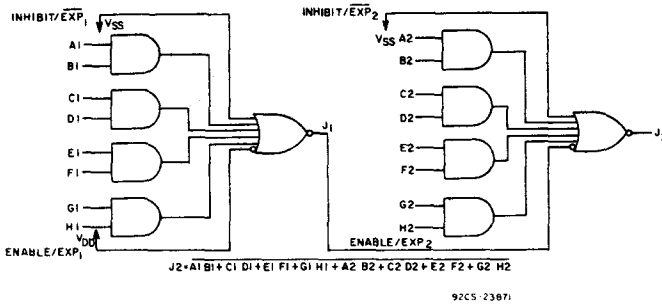

Fig. 10 - Two CD4086B's connected as an 8-wide 2-input A-O-I gate.

Fig. 10 above shows two CD4086's utilized to obtain an 8-wide 2-input A-O-I function. The output (J1) of one CD4086 is fed directly to the ENABLE/EXP2 line of the second CD4086. In a similar fashion, any

NAND gate output can be fed directly into the ENABLE/EXP input to obtain a 5-wide A-O-I function. In addition, any AND gate output can be fed directly into the INHIBIT/EXP input with the same result.

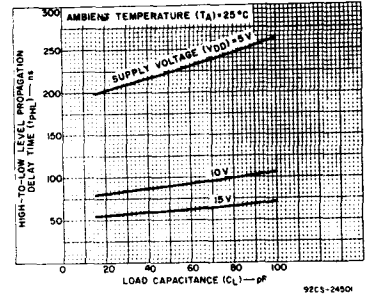

Fig. 11 - Typical DATA or ENABLE high-to-low level propagation delay time vs. load capacitance.

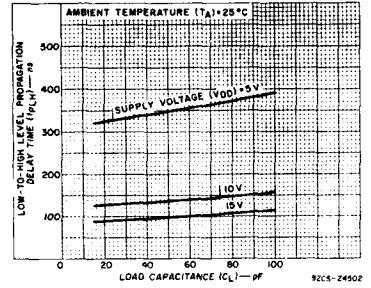

Fig. 12 - Typical DATA or ENABLE low-to-high level propagation delay time vs. load capacitance.

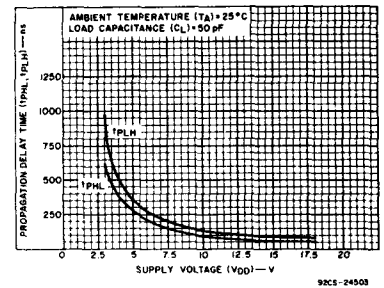

Fig. 13 - Typical DATA or ENABLE propagation delay time vs. supply voltage.

# CD4086B Types

## DYNAMIC ELECTRICAL CHARACTERISTICS

At  $T_A = 25^\circ\text{C}$ ; Input  $t_r, t_f = 20\text{ ns}$ ,  $C_L = 50\text{ pF}$ ,  $R_L = 200\text{ k}\Omega$

CHARACTERISTIC	CONDITIONS	LIMITS		UNITS	
		$V_{DD}$ (V)	TYP.		MAX.
Propagation Delay Time (Data): High-to-Low Level, $t_{pHL}$		5	225	450	ns
		10	90	180	
		15	60	120	
Low-to-High Level, $t_{pLH}$		5	310	620	ns
		10	125	250	
		15	90	180	
Propagation Delay Time (Inhibit): High-to-Low Level, $t_{pHL(INH)}$		5	150	300	ns
		10	60	120	
		15	40	80	
Low-to-High Level, $t_{pLH(INH)}$		5	250	500	ns
		10	100	200	
		15	70	140	
Transition Time, $t_{THL}, t_{TLH}$		5	100	200	ns
		10	50	100	
		15	40	80	
Input Capacitance $C_{IN}$	Any Input		5	7.5	pF

## TEST CIRCUITS

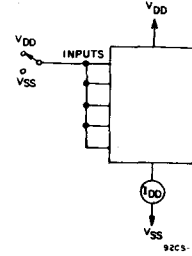

Fig. 14 — Quiescent device current.

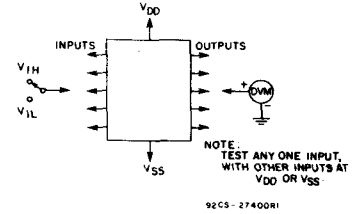
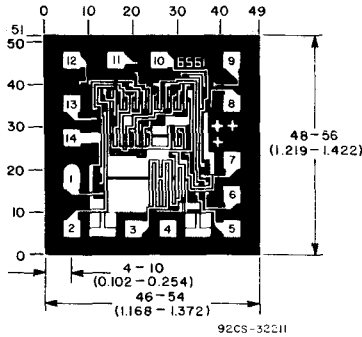

Fig. 15 — Input voltage.



Dimensions in parentheses are in millimeters and are derived from the basic inch dimensions as indicated. Grid graduations are in mils ( $10^{-3}$  inch).

The photographs and dimensions of each CMOS chip represent a chip when it is part of the wafer. When the wafer is separated into individual chips, the angle of cleavage may vary with respect to the chip face for different chips. The actual dimensions of the isolated chip, therefore, may differ slightly from the nominal dimensions shown. The user should consider a tolerance of  $-3$  mils to  $+16$  mils applicable to the nominal dimensions shown.

Dimensions and Pad Layout for the CD4086BH

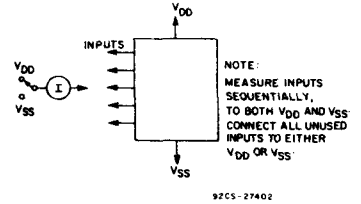

Fig. 16 — Input leakage current.

## CMOS Binary Rate Multiplier

High-Voltage Types (20-Volt Rating)

The RCA-CD4089B is a low-power 4-bit digital rate multiplier that provides an output pulse rate that is the clock-input-pulse rate multiplied by 1/16 times the binary input. For example, when the binary input number is 13, there will be 13 output pulses for every 16 input pulses. This device may be used in conjunction with an up/down counter and control logic used to perform arithmetic operations (adds, subtract, divide, raise to a power), solve algebraic and differential equations, generate natural logarithms and trigonometric functions, A/D and D/A conversions, and frequency division.

For words of more than 4 bits, CD4089B devices may be cascaded in two different modes: an Add mode and a Multiply mode (see Figs. 14 and 15). In the Add mode some of the gaps left by the more significant unit at the count of 15 are filled in by the less significant units. For example, when two units are cascaded in the Add mode and programmed to 11 and 13, respectively, the more significant unit will have 11 output pulses for every 16 input pulses and the other unit will have 13 output pulses for every 256 input pulses for a total of

$$\frac{11}{16} + \frac{13}{256} = \frac{189}{256}$$

In the Multiply mode the fraction programmed into the first rate multiplier is multiplied by the fraction programmed into the second multiplier. Thus the output rate will be

$$\frac{11}{16} \times \frac{13}{16} = \frac{143}{256}$$

### MAXIMUM RATINGS, Absolute-Maximum Values:

DC SUPPLY-VOLTAGE RANGE, ( $V_{DD}$ ) (Voltages referenced to $V_{SS}$ Terminal)	-0.5 to +20 V
INPUT VOLTAGE RANGE, ALL INPUTS	-0.5 to $V_{DD} + 0.5$ V
DC INPUT CURRENT, ANY ONE INPUT	$\pm 10$ mA
POWER DISSIPATION PER PACKAGE ( $P_D$ ):	
For $T_A = -40$ to $+60^\circ\text{C}$ (PACKAGE TYPE E)	500 mW
For $T_A = +60$ to $+85^\circ\text{C}$ (PACKAGE TYPE E)	Derate Linearly at $12 \text{ mW}/^\circ\text{C}$ to 200 mW
For $T_A = -55$ to $+100^\circ\text{C}$ (PACKAGE TYPES D, F, K)	500 mW
For $T_A = +100$ to $+125^\circ\text{C}$ (PACKAGE TYPES D, F, K)	Derate Linearly at $12 \text{ mW}/^\circ\text{C}$ to 200 mW
DEVICE DISSIPATION PER OUTPUT TRANSISTOR	
FOR $T_A = \text{FULL PACKAGE-TEMPERATURE RANGE}$ (All Package Types)	100 mW
OPERATING-TEMPERATURE RANGE ( $T_A$ ):	
PACKAGE TYPES D, F, K, H	$-55$ to $+125^\circ\text{C}$
PACKAGE TYPE E	$-40$ to $+85^\circ\text{C}$
STORAGE TEMPERATURE RANGE ( $T_{STG}$ )	
LEAD TEMPERATURE (DURING SOLDERING):	$-65$ to $+150^\circ\text{C}$
At distance $1/16 \pm 1/32$ inch ( $1.59 \pm 0.79$ mm) from case for 10 s max.	$+265^\circ\text{C}$

### Features:

- Cascadable in multiples of 4-bits
- Set to "15" input and "15" detect output
- 100% tested for quiescent current at 20 V
- 5-V, 10-V, and 15-V parametric ratings
- Standardized, symmetrical output characteristics
- Maximum input current of  $1 \mu\text{A}$  at 18 V over full package-temperature range; 100 nA at 18 V and  $25^\circ\text{C}$
- Noise margin (full package-temperature range) =

$$\begin{aligned} 1 \text{ V at } V_{DD} = 5 \text{ V} \\ 2 \text{ V at } V_{DD} = 10 \text{ V} \\ 2.5 \text{ V at } V_{DD} = 15 \text{ V} \end{aligned}$$

- Meets all requirements of JEDEC Tentative Standard No. 13A, "Standard Specifications for Description of 'B' Series CMOS Devices"

### Applications:

- Numerical control
- Instrumentation
- Digital filtering
- Frequency synthesis

The CD4089B has an internal synchronous 4-bit counter which, together with one of the four binary input bits, produces pulse trains as shown in Fig. 2.

If more than one binary input bit is high, the resulting pulse train is a combination of the separate pulse trains as shown in Fig. 2.

The CD4089B types are supplied in 16-lead ceramic dual-in-line packages (D and F suffixes), 16-lead dual-in-line plastic packages (E suffix), 16-lead ceramic flat packages (K suffix), and in chip form (H suffix).

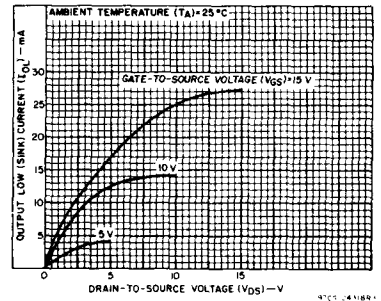
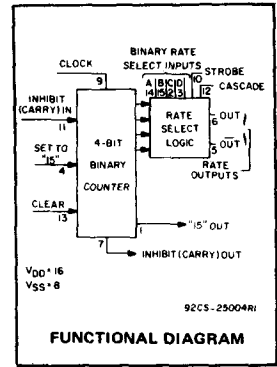

Fig. 1 — Typical output low (sink) current characteristics.

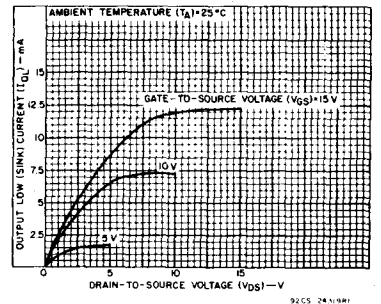

Fig. 2 — Minimum output low (sink) current characteristics.

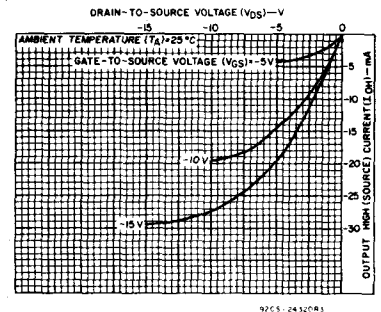

Fig. 3 — Typical output high (source) current characteristics.

# CD4089B Types

RECOMMENDED OPERATING CONDITIONS at  $T_A = 25^\circ\text{C}$ , Except as Noted. For maximum reliability, nominal operating conditions should be selected so that operation is always within the following ranges:

CHARACTERISTIC	$V_{DD}$ (V)	LIMITS		UNITS
		Min.	Max.	
Supply-Voltage Range (For $T_A =$ Full Package-Temperature Range)		3	18	V
Set or Clear Pulse Width, $t_W$	5 10 15	160 90 60	— — —	ns
Clock Pulse Width, $t_W$	5 10 15	330 170 100	— — —	ns
Clock Frequency, $f_{CL}$	5 10 15	dc	1.2 2.5 3.5	MHz
Clock Rise or Fall Time, $t_{rCL}$ or $t_{fCL}$	5, 10, 15	—	15	$\mu\text{s}$
Inhibit In Setup Time, $t_{SU}$	5 10 15	100 40 20	— — —	ns
Inhibit In Removal Time, $t_{REM}$	5 10 15	240 130 110	— — —	ns
Set Removal Time, $t_{REM}$	5 10 15	150 80 50	— — —	ns
Clear Removal Time, $t_{REM}$	5 10 15	60 40 30	— — —	ns

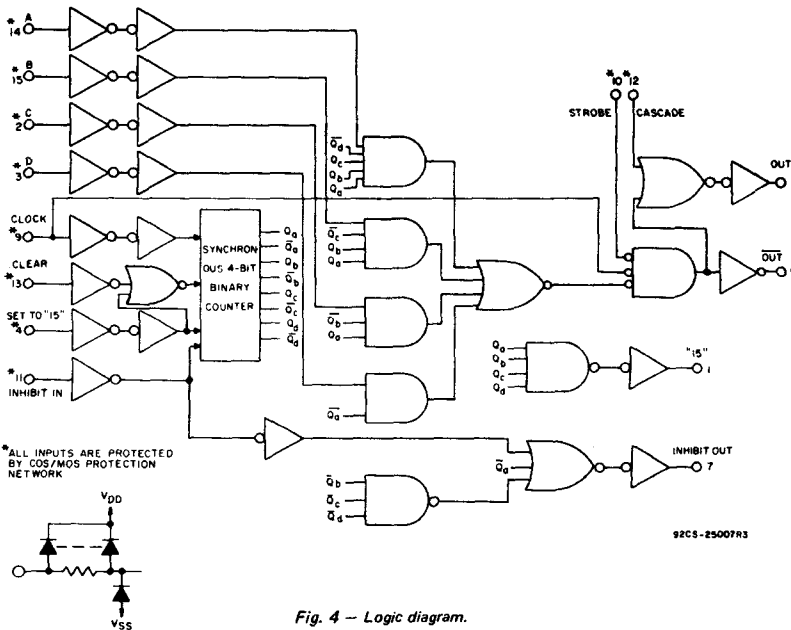

Fig. 4 - Logic diagram.

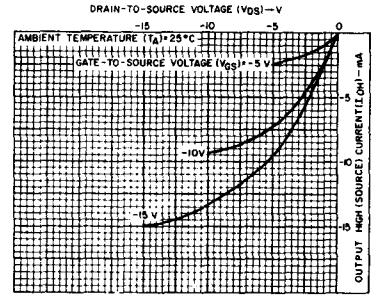

Fig. 5 - Minimum output high (source) current characteristics.

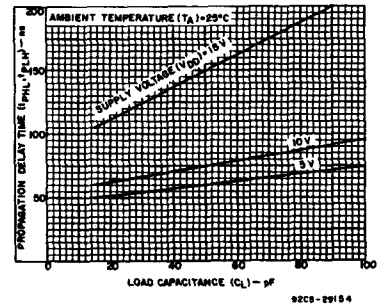

Fig. 6 - Typical propagation delay time as a function of load capacitance (Clock or Strobe to Out).

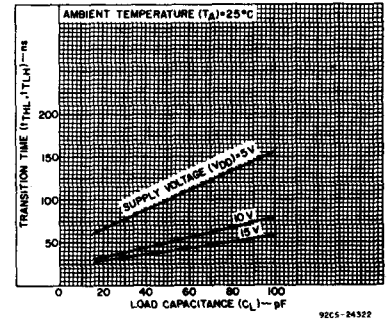

Fig. 7 - Typical transition time as a function of load capacitance.

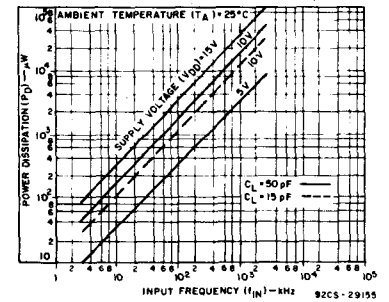

Fig. 8 - Typical dynamic power dissipation as a function of input frequency.



# CD4089B Types

**DYNAMIC ELECTRICAL CHARACTERISTICS** at  $T_A = 25^\circ\text{C}$ ;  
 Input  $t_r, t_f = 20\text{ ns}$ ,  $C_L = 50\text{ pF}$ ,  $R_L = 200\text{ k}\Omega$

CHARACTERISTIC	TEST CONDITIONS	LIMITS			UNITS	
		$V_{DD}$ V	Min.	Typ.		Max.
Propagation Delay Time, $t_{PHL}, t_{PLH}$ Clock to Out		5	—	110	220	ns
		10	—	55	110	
		15	—	45	90	
Clock or Strobe to Out		5	—	150	300	ns
		10	—	75	150	
		15	—	60	120	
Clock to Inhibit Out High Level to Low Level		5	—	360	720	ns
		10	—	160	320	
		15	—	110	220	
Low Level to High Level		5	—	250	500	ns
		10	—	100	200	
		15	—	75	150	
Clear to Out		5	—	380	760	ns
		10	—	175	350	
		15	—	130	260	
Clock to "9" or "15" Out		5	—	300	600	ns
		10	—	125	250	
		15	—	90	180	
Cascade to Out		5	—	90	180	ns
		10	—	45	90	
		15	—	35	70	
Inhibit In to Inhibit Out		5	—	160	320	ns
		10	—	75	150	
		15	—	55	110	
Set to Out		5	—	330	660	ns
		10	—	150	300	
		15	—	110	220	
Transition Time, $t_{THL}, t_{TLH}$		5	—	100	200	ns
		10	—	50	100	
		15	—	40	80	
Maximum Clock Frequency, $f_{CL}$		5	1.2	2.4	—	MHz
		10	2.5	5	—	
		15	3.5	7	—	
Minimum Clock Pulse Width, $t_W$		5	—	165	330	ns
		10	—	85	170	
		15	—	50	100	
Clock Rise or Fall Time, $t_{rCL}, t_{fCL}$		5	—	—	15	$\mu\text{s}$
		10	—	—	15	
		15	—	—	15	
Minimum Set or Clear Pulse Width, $t_W$		5	—	80	160	ns
		10	—	45	90	
		15	—	30	60	
Minimum Inhibit-In Setup Time, $t_{SU}$		5	—	50	100	ns
		10	—	20	40	
		15	—	10	20	
Minimum Inhibit In Removal Time, $t_{REM}$		5	—	120	240	ns
		10	—	65	130	
		15	—	55	110	

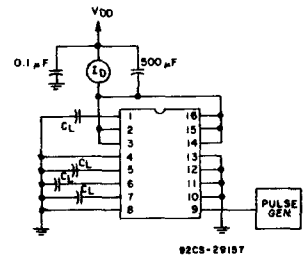

Fig. 9 — Dynamic power dissipation test circuit.

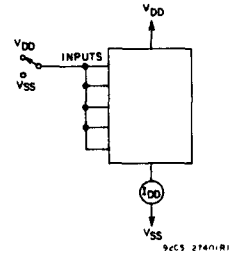

Fig. 10 — Quiescent device current test circuit.

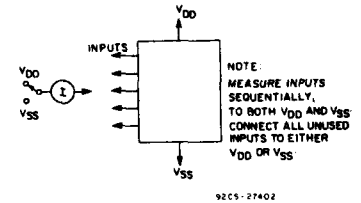

Fig. 11 — Input-current test circuit.

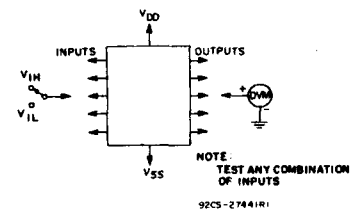
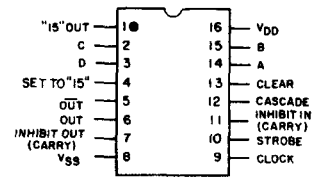

Fig. 12 — Input-voltage test circuit.



TOP VIEW  
 TERMINAL ASSIGNMENT

# CD4089B Types

## DYNAMIC ELECTRICAL CHARACTERISTICS at $T_A = 25^\circ\text{C}$ (cont'd)

Input  $t_r, t_f = 20\text{ ns}$ ,  $C_L = 50\text{ pF}$ ,  $R_L = 200\text{ k}\Omega$

CHARACTERISTIC	TEST CONDITIONS	LIMITS			UNITS	
		$V_{DD}$ V	Min.	Typ.		Max.
Minimum Set Removal Time, $t_{REM}$		5	–	75	150	ns
		10	–	40	80	
		15	–	25	50	
Minimum Clear Removal Time, $t_{REM}$		5	–	30	60	ns
		10	–	20	40	
		15	–	15	30	
Input Capacitance, $C_{IN}$	Any Input	–	–	5	7.5	pF

## STATIC ELECTRICAL CHARACTERISTICS

CHARACTERISTIC	CONDITIONS			LIMITS AT INDICATED TEMPERATURES ( $^\circ\text{C}$ )							UNITS
				Values at $-55, +25, +125$ Apply to D, F, K, H Packages							
				Values at $-40, +25, +85$ Apply to E Package							
$V_O$ (V)	$V_{IN}$ (V)	$V_{DD}$ (V)	$-55$	$-40$	$+85$	$+125$	$+25$				
							Min.	Typ.	Max.		
Quiescent Device Current, $I_{DD}$ Max.	–	0,5	5	5	5	150	150	–	0.04	5	$\mu\text{A}$
	–	0,10	10	10	10	300	300	–	0.04	10	
	–	0,15	15	20	20	600	600	–	0.04	20	
	–	0,20	20	100	100	3000	3000	–	0.08	100	
Output Low (Sink) Current, $I_{OL}$ Min.	0.4	0,5	5	0.64	0.61	0.42	0.36	0.51	1	–	mA
	0.5	0,10	10	1.6	1.5	1.1	0.9	1.3	2.6	–	
	1.5	0,15	15	4.2	4	2.8	2.4	3.4	6.8	–	
Output High (Source) Current, $I_{OH}$ Min.	4.6	0,5	5	–0.64	–0.61	–0.42	–0.36	–0.51	–1	–	mA
	2.5	0,5	5	–2	–1.8	–1.3	–1.15	–1.6	–3.2	–	
	9.5	0,10	10	–1.6	–1.5	–1.1	–0.9	–1.3	–2.6	–	
	13.5	0,15	15	–4.2	–4	–2.8	–2.4	–3.4	–6.8	–	
Output Voltage: Low-Level, $V_{OL}$ Max.	–	0,5	5	0.05			–	0	0.05	–	V
	–	0,10	10	0.05			–	0	0.05	–	
	–	0,15	15	0.05			–	0	0.05	–	
Output Voltage: High-Level, $V_{OH}$ Min.	–	0,5	5	4.95			4.95	5	–	–	V
	–	0,10	10	9.95			9.95	10	–	–	
	–	0,15	15	14.95			14.95	15	–	–	
Input Low Voltage, $V_{IL}$ Max.	0.5,4.5	–	5	1.5			–	–	1.5	–	V
	1.9	–	10	3			–	–	3	–	
	1.5,13.5	–	15	4			–	–	4	–	
Input High Voltage, $V_{IH}$ Min.	0.5,4.5	–	5	3.5			3.5	–	–	–	V
	1.9	–	10	7			7	–	–	–	
	1.5,13.5	–	15	11			11	–	–	–	
Input Current $I_{IN}$ Max.	–	0,18	18	$\pm 0.1$	$\pm 0.1$	$\pm 1$	$\pm 1$	–	$\pm 10^{-5}$	$\pm 0.1$	$\mu\text{A}$

# CD4089B Types

TRUTH TABLE

INPUTS										OUTPUTS			
Number of Pulses or Input Logic Level (0 = Low; 1 = High; X = Don't Care)										Number of Pulses or Output Logic Level (L = Low; H = High)			
D	C	B	A	CLK	INH IN	STR	CAS	CLR	SET	OUT	OUT	INH OUT	"15" OUT
0	0	0	0	16	0	0	0	0	0	L	H	1	1
0	0	0	1	16	0	0	0	0	0	1	1	1	1
0	0	1	0	16	0	0	0	0	0	2	2	1	1
0	0	1	1	16	0	0	0	0	0	3	3	1	1
0	1	0	0	16	0	0	0	0	0	4	4	1	1
0	1	0	1	16	0	0	0	0	0	5	5	1	1
0	1	1	0	16	0	0	0	0	0	6	6	1	1
0	1	1	1	16	0	0	0	0	0	7	7	1	1
1	0	0	0	16	0	0	0	0	0	8	8	1	1
1	0	0	1	16	0	0	0	0	0	9	9	1	1
1	0	1	0	16	0	0	0	0	0	10	10	1	1
1	0	1	1	16	0	0	0	0	0	11	11	1	1
1	1	0	0	16	0	0	0	0	0	12	12	1	1
1	1	0	1	16	0	0	0	0	0	13	13	1	1
1	1	1	0	16	0	0	0	0	0	14	14	1	1
1	1	1	1	16	0	0	0	0	0	15	15	1	1
X	X	X	X	16	1	0	0	0	0	†	†	H	†
X	X	X	X	16	0	1	0	0	0	L	H	1	1
X	X	X	X	16	0	0	1	0	0	H	*	1	1
1	X	X	X	16	0	0	0	1	0	16	16	H	L
0	X	X	X	16	0	0	0	1	0	L	H	H	L
X	X	X	X	16	0	0	0	X	1	L	H	L	H

\* Output same as the first 16 lines of this truth table (depending on values of A, B, C, D).  
 † Depends on internal state of counter.

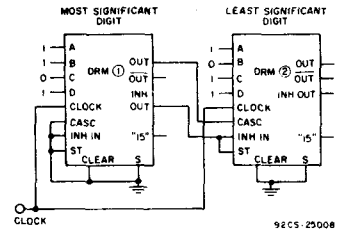

Fig. 13 - Two CD4089B's cascaded in the "Add" mode with a preset number of 189  $\left(\frac{11}{16} + \frac{13}{256} = \frac{189}{256}\right)$ .

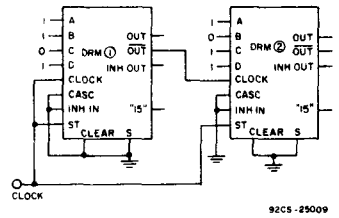
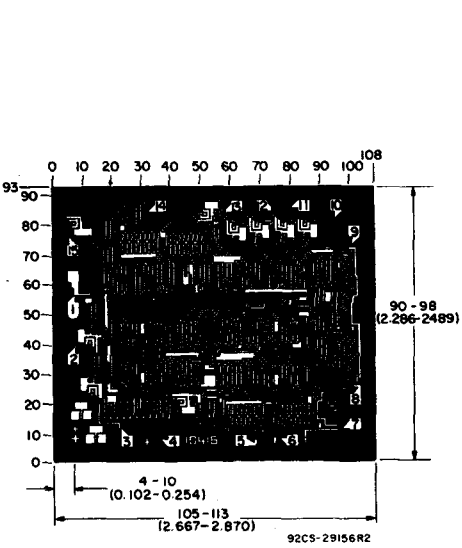

Fig. 14 - Two CD4089B's cascaded in the "Multiply" mode with a preset number of 143  $\left(\frac{11}{16} \times \frac{13}{16} = \frac{143}{256}\right)$ .



Dimensions and Pad Layout for CD4089BH

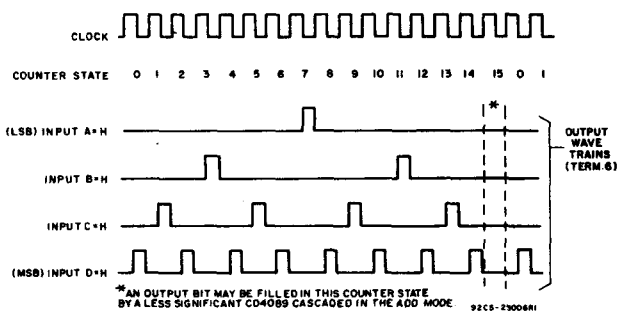

Fig. 15 - Timing diagram.

Dimensions in parentheses are in millimeters and are derived from the basic inch dimensions as indicated. Grid graduations are in mils (10<sup>-3</sup> inch).

The photographs and dimensions of each CMOS chip represent a chip when it is part of the wafer. When the wafer is separated into individual chips, the angle of cleavage may vary with respect to the chip face for different chips. The actual dimensions of the isolated chip, therefore, may differ slightly from the nominal dimensions shown. The user should consider a tolerance of -3 mils to +16 mils applicable to the nominal dimensions shown.

# CD4093B Types

## CMOS Quad 2-Input NAND Schmitt Triggers

High-Voltage Types (20 Volt Rating)

The RCA-CD4093B consists of four Schmitt-trigger circuits. Each circuit functions as a two-input NAND gate with Schmitt-trigger action on both inputs. The gate switches at different points for positive- and negative-going signals. The difference between the positive voltage ( $V_P$ ) and the negative voltage ( $V_N$ ) is defined as hysteresis voltage ( $V_H$ ) (see Fig. 2).

The CD4093B types are supplied in 14-lead hermetic dual-in-line ceramic packages (D and F suffixes), 14-lead dual-in-line plastic package (E suffix), 14-lead ceramic flat package (K suffix), and in chip form (H suffix).

### Features:

- Schmitt-trigger action on each input with no external components
- Hysteresis voltage typically 0.9 V at  $V_{DD} = 5$  V and 2.3 V at  $V_{DD} = 10$  V
- Noise immunity greater than 50%
- No limit on input rise and fall times
- Standardized, symmetrical output characteristics
- 100% tested for quiescent current at 20 V
- Maximum input current of 1  $\mu$ A at 18 V over full package-temperature range, 100 nA at 18 V and 25°C
- 5-V, 10-V, and 15-V parametric ratings
- Meets all requirements of JEDEC Tentative Standard No. 13A, "Standard Specifications for Description of 'B' Series CMOS Devices"

### Applications:

- Wave and pulse shapers
- High-noise-environment systems
- Monostable multivibrators
- Astable multivibrators
- NAND logic

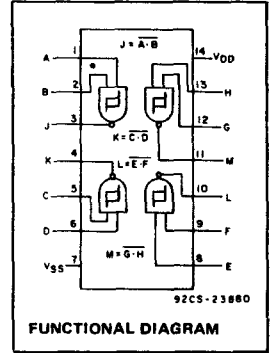

### RECOMMENDED OPERATING CONDITIONS

For maximum reliability, nominal operating conditions should be selected so that operation is always within the following ranges.

CHARACTERISTIC	MIN.	MAX.	UNITS
Supply-Voltage Range ( $T_A$ = Full Package-Temp. Range)	3	18	V

### MAXIMUM RATINGS, Absolute-Maximum Values:

DC SUPPLY-VOLTAGE RANGE, ( $V_{DD}$ ) (Voltages referenced to $V_{SS}$ Terminal)	-0.5 to +20 V
INPUT VOLTAGE RANGE, ALL INPUTS	-0.5 to $V_{DD} + 0.5$ V
DC INPUT CURRENT, ANY ONE INPUT	$\pm 10$ mA
POWER DISSIPATION PER PACKAGE ( $P_D$ ):	
For $T_A = -40$ to $+80^\circ\text{C}$ (PACKAGE TYPE E)	500 mW
For $T_A = +60$ to $+85^\circ\text{C}$ (PACKAGE TYPE E)	Derate Linearly at 12 mW/ $^\circ\text{C}$ to 200 mW
For $T_A = -55$ to $+100^\circ\text{C}$ (PACKAGE TYPES D, F, K)	500 mW
For $T_A = +100$ to $+125^\circ\text{C}$ (PACKAGE TYPES D, F, K)	Derate Linearly at 12 mW/ $^\circ\text{C}$ to 200 mW
DEVICE DISSIPATION PER OUTPUT TRANSISTOR FOR $T_A$ = FULL PACKAGE-TEMPERATURE RANGE (All Package Types)	100 mW
OPERATING-TEMPERATURE RANGE ( $T_A$ ):	
PACKAGE TYPES D, F, K, H	-55 to $+125^\circ\text{C}$
PACKAGE TYPE E	-40 to $+85^\circ\text{C}$
STORAGE TEMPERATURE RANGE ( $T_{stg}$ )	-65 to $+150^\circ\text{C}$
LEAD TEMPERATURE (DURING SOLDERING):	
At distance $1/16 \pm 1/32$ inch (1.59 $\pm$ 0.79 mm) from case for 10 s max.	$+265^\circ\text{C}$

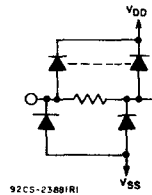
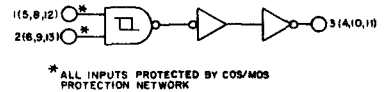

Fig. 1 - Logic diagram - 1 of 4 Schmitt triggers.

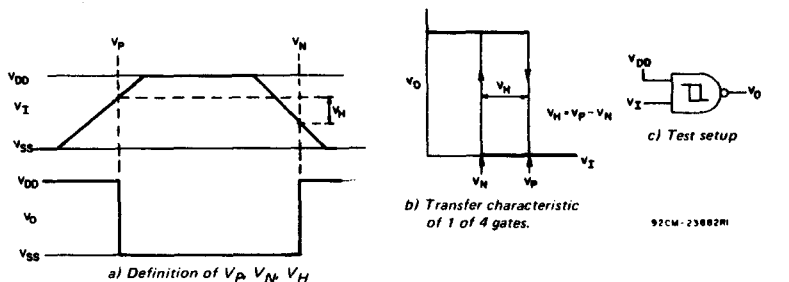

Fig. 2 - Hysteresis definition, characteristic, and test setup.

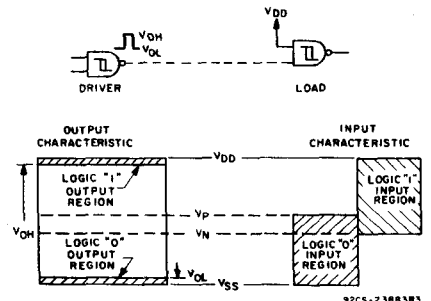

Fig. 3 - Input and output characteristics.

# CD4093B Types

## STATIC ELECTRICAL CHARACTERISTICS

CHARACTERISTIC	CONDITIONS			LIMITS AT INDICATED TEMPERATURES (°C)							UNITS
				Values at -55, +25, +125 Apply to D, F, K, H Packages Values at -40, +25, +85 Apply to E Packages							
	V <sub>O</sub> (V)	V <sub>IN</sub> (V)	V <sub>DD</sub> (V)	-55	-40	+85	+125	+25			
								MIN.	TYP.	MAX.	
Quiescent Device Current, I <sub>DD</sub> Max.	-	0,5	5	1	1	30	30	-	0.02	1	μA
	-	0,10	10	2	2	60	60	-	0.02	2	
	-	0,15	15	4	4	120	120	-	0.02	4	
	-	0,20	20	20	20	600	600	-	0.04	20	
Positive Trigger Threshold Voltage V <sub>p</sub> Min.	-	a	5	2.2	2.2	2.2	2.2	2.2	2.9	-	V
	-	a	10	4.6	4.6	4.6	4.6	4.6	5.9	-	
	-	a	15	6.8	6.8	6.8	6.8	6.8	8.8	-	
	-	b	5	2.6	2.6	2.6	2.6	2.6	3.3	-	
	-	b	10	5.6	5.6	5.6	5.6	5.6	7	-	
	-	b	15	6.3	6.3	6.3	6.3	6.3	9.4	-	
V <sub>p</sub> Max.	-	a	5	3.6	3.6	3.6	3.6	-	2.9	3.6	V
	-	a	10	7.1	7.1	7.1	7.1	-	5.9	7.1	
	-	a	15	10.8	10.8	10.8	10.8	-	8.8	10.8	
	-	b	5	4	4	4	4	-	3.3	4	
	-	b	10	8.2	8.2	8.2	8.2	-	7	8.2	
	-	b	15	12.7	12.7	12.7	12.7	-	9.4	12.7	
Negative Trigger Threshold Voltage V <sub>N</sub> Min.	-	a	5	0.9	0.9	0.9	0.9	0.9	1.9	-	V
	-	a	10	2.5	2.5	2.5	2.5	2.5	3.9	-	
	-	a	15	4	4	4	4	4	5.8	-	
	-	b	5	1.4	1.4	1.4	1.4	1.4	2.3	-	
	-	b	10	3.4	3.4	3.4	3.4	3.4	5.1	-	
	-	b	15	4.8	4.8	4.8	4.8	4.8	7.3	-	
V <sub>N</sub> Max.	-	a	5	2.8	2.8	2.8	2.8	-	1.9	2.8	V
	-	a	10	5.2	5.2	5.2	5.2	-	3.9	5.2	
	-	a	15	7.4	7.4	7.4	7.4	-	5.8	7.4	
	-	b	5	3.2	3.2	3.2	3.2	-	2.3	3.2	
	-	b	10	6.6	6.6	6.6	6.6	-	5.1	6.6	
	-	b	15	9.6	9.6	9.6	9.6	-	7.3	9.6	
Hysteresis Voltage V <sub>H</sub> Min.	-	a	5	0.3	0.3	0.3	0.3	0.3	0.9	-	V
	-	a	10	1.2	1.2	1.2	1.2	1.2	2.3	-	
	-	a	15	1.6	1.6	1.6	1.6	1.6	3.5	-	
	-	b	5	0.3	0.3	0.3	0.3	0.3	0.9	-	
	-	b	10	1.2	1.2	1.2	1.2	1.2	2.3	-	
	-	b	15	1.6	1.6	1.6	1.6	1.6	3.5	-	
V <sub>H</sub> Max.	-	a	5	1.6	1.6	1.6	1.6	-	0.9	1.6	V
	-	a	10	3.4	3.4	3.4	3.4	-	2.3	3.4	
	-	a	15	5	5	5	5	-	3.5	5	
	-	b	5	1.6	1.6	1.6	1.6	-	0.9	1.6	
	-	b	10	3.4	3.4	3.4	3.4	-	2.3	3.4	
	-	b	15	5	5	5	5	-	3.5	5	

<sup>a</sup> Input on terminals 1, 5, 8, 12 or 2, 6, 9, 13; other inputs to V<sub>DD</sub>.

<sup>b</sup> Input on terminals 1 and 2, 5 and 6, 8 and 9, or 12 and 13; other inputs to V<sub>DD</sub>.

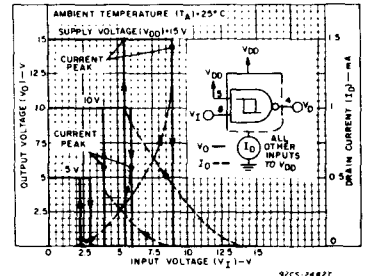

Fig. 4 - Typical current and voltage transfer characteristics.

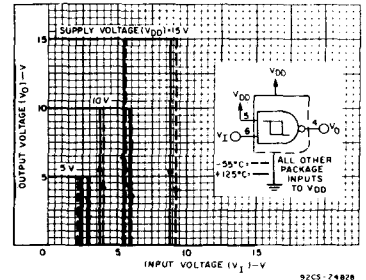

Fig. 5 - Typical voltage transfer characteristics as a function of temperature.

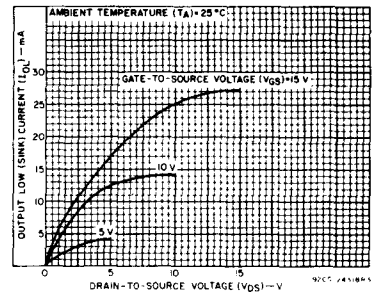

Fig. 6 - Typical output low (sink) current characteristics.

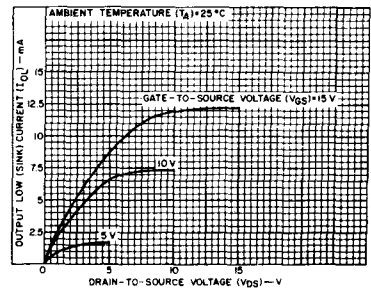

Fig. 7 - Minimum output low (sink) current characteristics.

# CD4093B Types

## STATIC ELECTRICAL CHARACTERISTICS (CONT'D)

CHARACTERISTIC	CONDITIONS			LIMITS AT INDICATED TEMPERATURE (°C)							UNITS
				Values at -55, +25, +125 Apply to D, F, K, H Packages							
				Values at -40, +25, +85 Apply to E Packages							
$V_O$ (V)	$V_{IN}$ (V)	$V_{DD}$ (V)	-55	-40	+85	+125	+25				
								MIN.	TYP.	MAX.	
Output Low (Sink) Current, $I_{OL}$ Min.	0.4	0.5	5	0.64	0.61	0.42	0.36	0.51	1	—	mA
	0.5	0.10	10	1.6	1.5	1.1	0.9	1.3	2.6	—	
	1.5	0.15	15	4.2	4	2.8	2.4	3.4	6.8	—	
Output High (Source) Current, $I_{OH}$ Min.	4.6	0.5	5	-0.64	-0.61	-0.42	-0.36	-0.51	-1	—	mA
	2.5	0.5	5	-2	-1.8	-1.3	-1.15	-1.6	-3.2	—	
	9.5	0.10	10	-1.6	-1.5	-1.1	-0.9	-1.3	-2.6	—	
	13.5	0.15	15	-4.2	-4	-2.8	-2.4	-3.4	-6.8	—	
Output Voltage Low-Level, $V_{OL}$ Max.	—	0.5	5	0.05			—	—	0	0.05	V
	—	0.10	10	0.05			—	—	0	0.05	
	—	0.15	15	0.05			—	—	0	0.05	
Output Voltage High-Level, $V_{OH}$ Min.	—	0.5	5	4.95			—	4.95	5	—	V
	—	0.10	10	9.95			—	9.95	10	—	
	—	0.15	15	14.95			—	14.95	—	—	
Input Current, $I_{IN}$ Max.	—	0.18	18	+0.1	+0.1	±1	±1	—	±10 <sup>-5</sup>	±0.1	μA

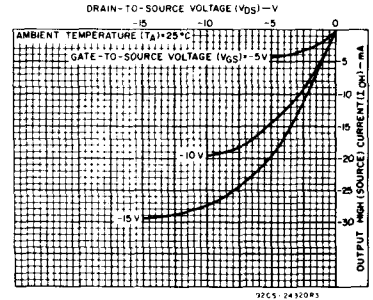

Fig. 8 - Typical output high (source) current characteristics.

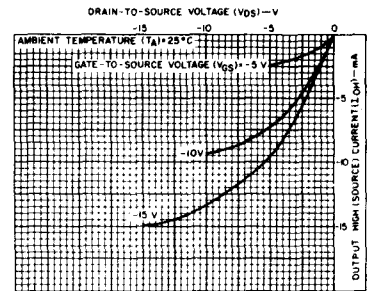

Fig. 9 - Minimum output high (source) current characteristics.

## DYNAMIC ELECTRICAL CHARACTERISTICS

At  $T_A = 25^\circ\text{C}$ ; Input  $t_r, t_f = 20\text{ ns}$ ,  $C_L = 50\text{ pF}$ ,  $R_L = 200\text{ k}\Omega$

CHARACTERISTIC	TEST CONDITIONS	LIMITS			UNITS
		$V_{DD}$ VOLTS	TYP.	MAX.	
Propagation Delay Time: $t_{PHL}$ $t_{PLH}$		5	190	380	ns
		10	90	180	
		15	65	130	
Transition Time, $t_{THL}$ $t_{TLH}$		5	100	200	ns
		10	50	100	
		15	40	80	
Input Capacitance, $C_{IN}$	Any Input		5	7.5	pF

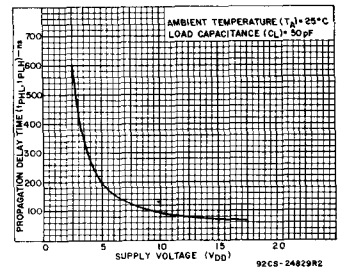

Fig. 10 - Typical propagation delay time vs. supply voltage.

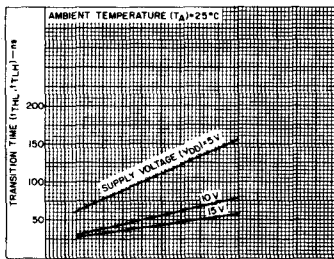

Fig. 11 - Typical transition time vs. load capacitance.

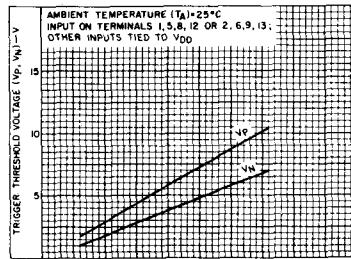

Fig. 12 - Typical trigger threshold voltage vs.  $V_{DD}$ .

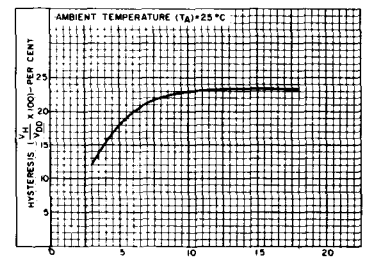

Fig. 13 - Typical per cent hysteresis vs. supply voltage.

# CD4093B Types

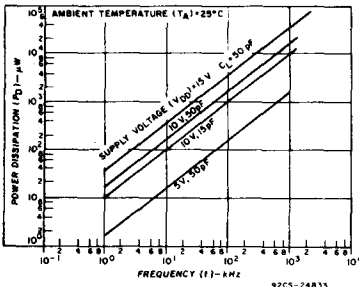

Fig. 14 - Typical power dissipation vs. frequency characteristics.

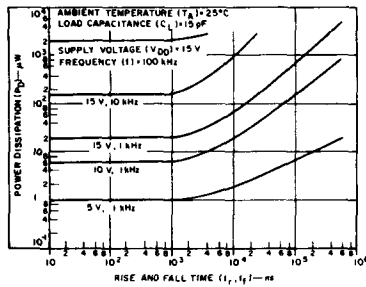

Fig. 15 - Typical power dissipation vs. rise and fall times.

## APPLICATIONS

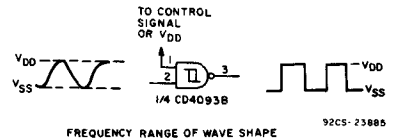

Fig. 16 - Wave shaper.

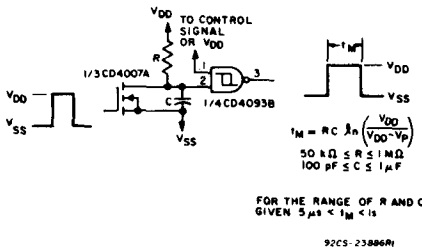

Fig. 17 - Monostable multivibrator.

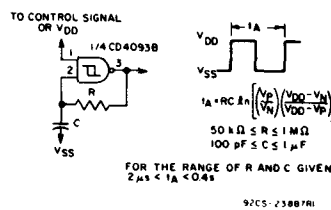

Fig. 18 - Astable multivibrator.

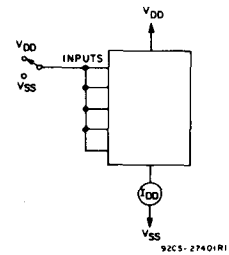

Fig. 19 - Quiescent device current test circuit.

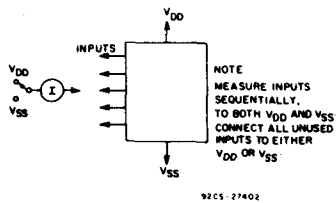
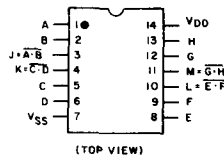
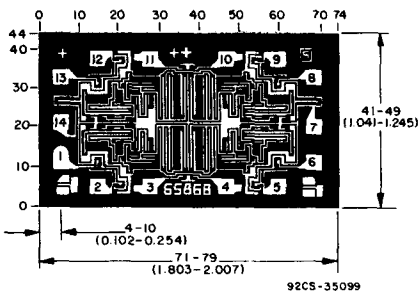

Fig. 20 - Input current test circuit.



TERMINAL ASSIGNMENT



Dimensions and Pad Layout for CD4093BH

Dimensions in parenthesis are in millimeters and are derived from the basic inch dimensions as indicated. Grid graduations are in mils ( $10^{-3}$  inch).

The photographs and dimensions of each CMOS chip represent a chip when it is part of the wafer. When the wafer is separated into individual chips, the angle of cleavage may vary with respect to the chip face for different chips. The actual dimensions of the isolated chip, therefore, may differ slightly from the nominal dimensions shown. The user should consider a tolerance of  $-3$  mils to  $+16$  mils applicable to the nominal dimensions shown.

# CD4094B Types

## CMOS 8-Stage Shift-and-Store Bus Register

High-Voltage Types (20-Volt Rating)

The RCA-CD4094B is an 8-stage serial shift register having a storage latch associated with each stage for strobing data from the serial input to parallel buffered 3-state outputs. The parallel outputs may be connected directly to common bus lines. Data is shifted on positive clock transitions. The data in each shift register stage is transferred to the storage register when the STROBE input is high. Data in the storage register appears at the outputs whenever the OUTPUT-ENABLE signal is high.

Two serial outputs are available for cascading a number of CD4094B devices. Data is available at the Q<sub>S</sub> serial output terminal on positive clock edges to allow for high-speed operation in cascaded systems in which the clock rise time is fast. The same serial information, available at the Q<sub>S</sub> terminal on the next negative clock edge, provides a means for cascading CD4094B devices when the clock rise time is slow.

The CD4094B types are supplied in 16-lead hermetic dual-in-line ceramic packages (D and F suffixes), 16-lead dual-in-line plastic package (E suffix), 16-lead ceramic flat package (K suffix), and in chip form (H suffix).

### Features:

- 3-state parallel outputs for connection to common bus
- Separate serial outputs synchronous to both positive and negative clock edges for cascading
- Medium speed operation — 5 MHz at 10 V (typ.)
- Standardized, symmetrical output characteristics
- 100% tested for quiescent current at 20 V
- Maximum input current of 1  $\mu$ A at 18 V over full package-temperature range; 100 nA at 18 V and 25°C
- Noise margin (full package temperature range): 1 V at V<sub>DD</sub> = 5 V      2 V at V<sub>DD</sub> = 10 V  
2.5 V at V<sub>DD</sub> = 15 V
- 5-V, 10-V, and 15-V parametric ratings
- Meets all requirements of JEDEC Tentative Standard No. 13A, "Standard Specifications for Description of 'B' Series CMOS Devices"

### Applications:

- Serial-to-parallel data conversion
- Remote control holding register
- Dual-rank shift, hold, and bus applications

### MAXIMUM RATINGS, Absolute-Maximum Values:

DC SUPPLY-VOLTAGE RANGE, (V <sub>DD</sub> )	..... -0.5 to +20 V
(Voltages referenced to V <sub>SS</sub> Terminal)	
INPUT VOLTAGE RANGE, ALL INPUTS	..... -0.5 to V <sub>DD</sub> +0.5 V
DC INPUT CURRENT, ANY ONE INPUT	..... $\pm$ 10 mA
POWER DISSIPATION PER PACKAGE (P <sub>D</sub> ):	
For T <sub>A</sub> = -40 to +60°C (PACKAGE TYPE E)	..... 500 mW
For T <sub>A</sub> = +60 to +85°C (PACKAGE TYPE E)	..... Derate Linearly at 12 mW/°C to 200 mW
For T <sub>A</sub> = -55 to +100°C (PACKAGE TYPES D, F, K)	..... 500 mW
For T <sub>A</sub> = +100 to +125°C (PACKAGE TYPES D, F, K)	..... Derate Linearly at 12 mW/°C to 200 mW
DEVICE DISSIPATION PER OUTPUT TRANSISTOR:	
For T <sub>A</sub> = FULL PACKAGE-TEMPERATURE RANGE (All Package Types)	..... 100 mW
OPERATING-TEMPERATURE RANGE (T <sub>A</sub> ):	
PACKAGE TYPES D, F, K, H	..... -55 to +125°C
PACKAGE TYPE E	..... -40 to +85°C
STORAGE TEMPERATURE RANGE (T <sub>stg</sub> )	..... -65 to +150°C
LEAD TEMPERATURE (DURING SOLDERING):	
At distance 1/16 $\pm$ 1/32 inch (1.59 $\pm$ 0.79 mm) from case for 10 s max.	..... +265°C

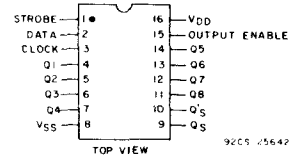
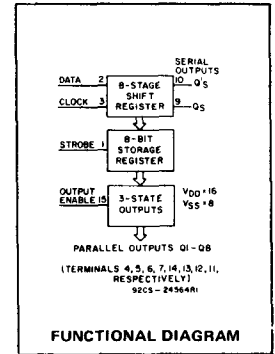
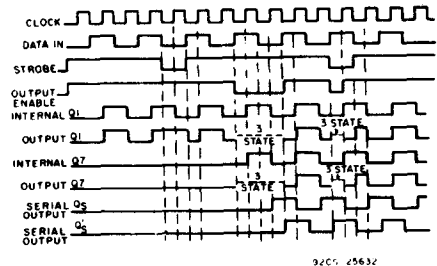
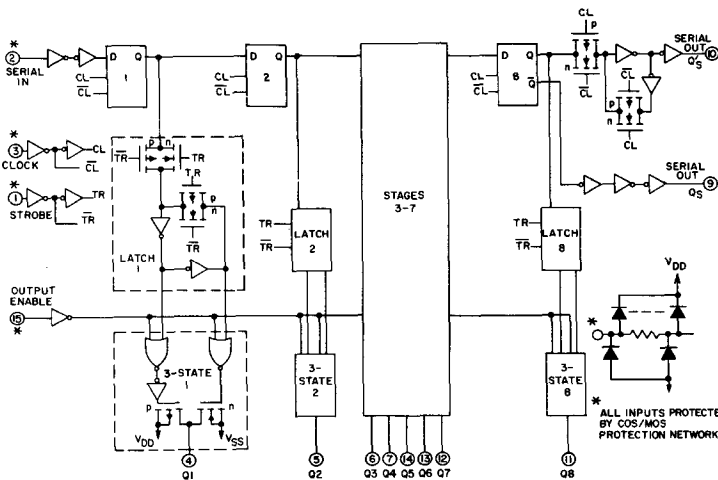

Fig. 1 — Terminal assignment.





# CD4094B Types

**RECOMMENDED OPERATING CONDITIONS at  $T_A = 25^\circ\text{C}$ , Except as Noted.**  
 For maximum reliability, nominal operating conditions should be selected so that operation is always within the following ranges:

CHARACTERISTIC	VDD (V)	LIMITS		UNITS
		MIN.	MAX.	
Supply-Voltage Range (For $T_A$ =Full Package-Temperature Range)		3	18	V
Data Setup Time, $t_S$	5 10 15	125 55 35	—	ns
Clock Pulse Width, $t_W$	5 10 15	200 100 83	—	ns
Clock Input Frequency, $f_{CL}$	5 10 15	dc	1.25 2.5 3	MHz
Clock Input Rise or Fall time, $t_{rCL}, t_{fCL}$ *	5 10 15	—	15 5 5	$\mu\text{s}$
Strobe Pulse Width, $t_W$	5 10 15	200 80 70	—	ns

\*If more than one unit is cascaded  $t_{fCL}$  (for  $Q_S$  only) should be made less than or equal to the sum of the fixed propagation delay at 50 pF and the transition time of the output driving stage for the estimated capacitive load.

TRUTH TABLE

CL <sup>A</sup>	Output Enable	Strobe	Data	Parallel Outputs		Serial Outputs	
				Q1	Q2	Q3*	Q4*
0	X	X	X	OC	OC	Q7	NC
0	X	X	X	OC	OC	NC	Q7
1	0	X	X	NC	NC	Q7	NC
1	1	0	0	Q <sub>N-1</sub>	Q <sub>N-1</sub>	Q7	NC
1	1	1	1	Q <sub>N-1</sub>	Q <sub>N-1</sub>	NC	Q7
1	1	1	1	NC	NC	NC	Q7

<sup>A</sup> = Level Change  
 X = Don't Care  
 NC = No Change  
 OC = Open Circuit

Logic 1  $\equiv$  High  
 Logic 0  $\equiv$  Low

\* At the positive clock edge information in the 7th shift register stage is transferred to the 8th register stage and the  $Q_S$  output.

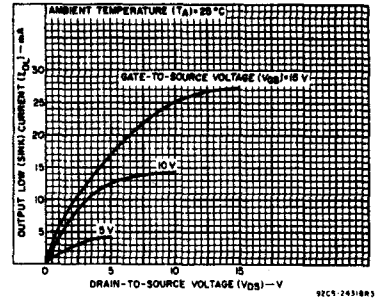

Fig. 4 - Typical output low (sink) current characteristics.

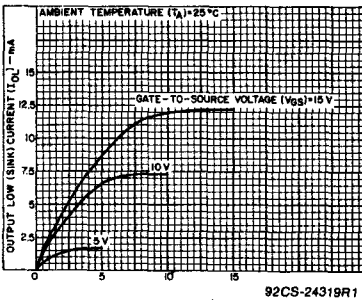

Fig. 5 - Minimum output low (sink) current characteristics.

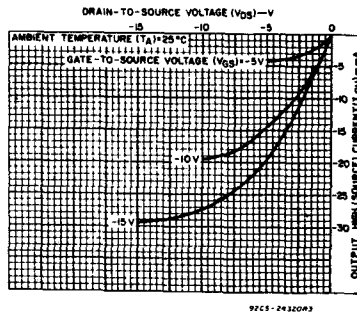

Fig. 6 - Typical output high (source) current characteristics.

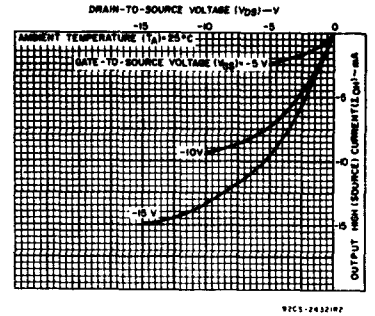

Fig. 7 - Minimum output high (source) current characteristics.

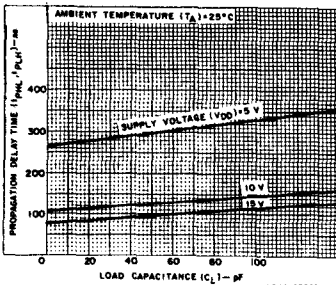

Fig. 8 - Clock-to-serial output  $Q_S$  propagation delay vs  $C_L$ .

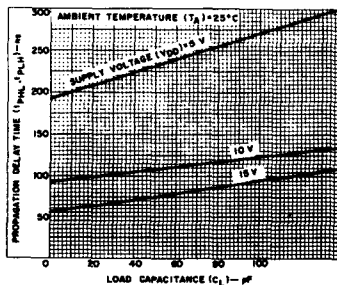

Fig. 9 - Clock-to-serial output  $Q'_S$  propagation delay vs  $C_L$ .

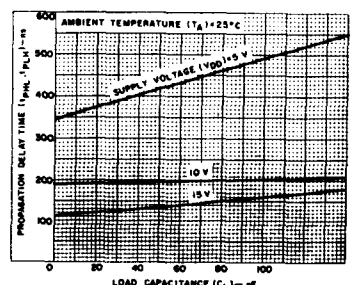

Fig. 10 - Clock-to-parallel output propagation delay vs  $C_L$ .

# CD4094B Types

## STATIC ELECTRICAL CHARACTERISTICS

CHARACTERISTIC	CONDITIONS			LIMITS AT INDICATED TEMPERATURES (°C)							UNITS
	V <sub>O</sub> (V)	V <sub>IN</sub> (V)	V <sub>DD</sub> (V)	+25							
				-55	-40	+85	+125	Min.	Typ.	Max.	
Quiescent Device Current, I <sub>DD</sub> Max.	—	0,5	5	5	5	150	150	—	0.04	5	μA
	—	0,10	10	10	10	300	300	—	0.04	10	
	—	0,15	15	20	20	600	600	—	0.04	20	
	—	0,20	20	100	100	3000	3000	—	0.08	100	
Output Low (Sink) Current I <sub>OL</sub> Min.	0.4	0,5	5	0.64	0.61	0.42	0.36	0.51	1	—	mA
	0.5	0,10	10	1.6	1.5	1.1	0.9	1.3	2.6	—	
	1.5	0,15	15	4.2	4	2.8	2.4	3.4	6.8	—	
Output High (Source) Current, I <sub>OH</sub> Min.	4.6	0,5	5	-0.64	-0.61	-0.42	-0.36	-0.51	-1	—	mA
	2.5	0,5	5	-2	-1.8	-1.3	-1.15	-1.6	-3.2	—	
	9.5	0,10	10	-1.6	-1.5	-1.1	-0.9	-1.3	-2.6	—	
	13.5	0,15	15	-4.2	-4	-2.8	-2.4	-3.4	-6.8	—	
Output Voltage: Low-Level, VOL Max.	—	0,5	5	0.05			—	0	0.05	—	V
	—	0,10	10	0.05			—	0	0.05	—	
	—	0,15	15	0.05			—	0	0.05	—	
Output Voltage: High-Level, VOH Min.	—	0,5	5	4.95			4.95	5	—	—	V
	—	0,10	10	9.95			9.95	10	—	—	
	—	0,15	15	14.95			14.95	15	—	—	
Input Low Voltage, VIL Max.	0.5, 4.5	—	5	1.5			—	—	1.5	—	V
	1, 9	—	10	3			—	—	3	—	
	1.5, 13.5	—	15	4			—	—	4	—	
Input High Voltage, VIH Min.	0.5, 4.5	—	5	3.5			3.5	—	—	—	V
	1, 9	—	10	7			7	—	—	—	
	1.5, 13.5	—	15	11			11	—	—	—	
Input Current I <sub>IN</sub> Max.	—	0,18	18	±0.1	±0.1	±1	±1	—	±10 <sup>-5</sup>	±0.1	μA
3-State Output Leakage Current I <sub>OQT</sub> Max.	0,18	0,18	18	±0.4	±0.4	±12	±12	—	±10 <sup>-4</sup>	±0.4	μA

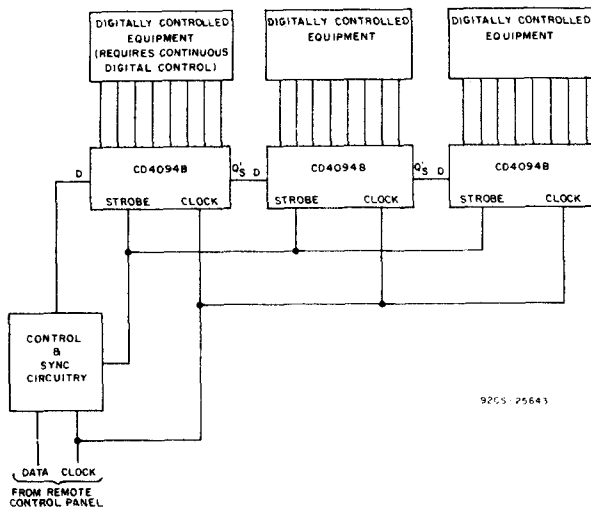

Fig. 14 — Remote control holding register.

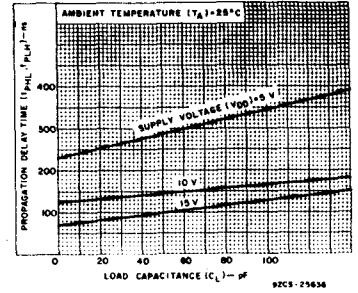

Fig. 11 — Strobe-to-parallel output propagation delay vs. C<sub>L</sub>.

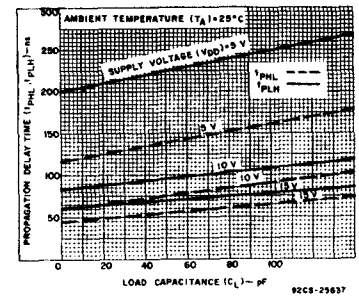

Fig. 12 — Output enable-to-parallel output propagation delay vs. C<sub>L</sub>.

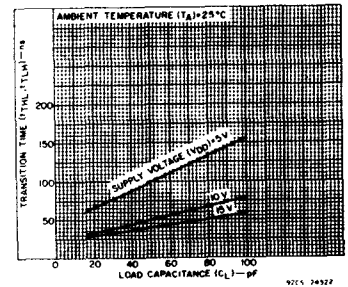

Fig. 13 — Typical transition time vs. load capacitance.

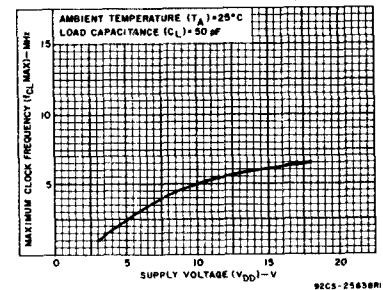

Fig. 15 — Typical maximum-clock-frequency vs. supply voltage.

# CD4094B Types

## DYNAMIC ELECTRICAL CHARACTERISTICS

At  $T_A=25^\circ\text{C}$ ; Input  $t_r, t_f = 20\text{ ns}$ ,  $C_L = 50\text{ pF}$ ,  $R_L = 200\text{ k}\Omega$

CHARACTERISTIC	V <sub>DD</sub> (V)	LIMITS			UNITS
		MIN.	TYP.	MAX.	
Propagation Delay Time, $t_{PHL}, t_{PLH}$ Clock to Serial Output $Q_S$	5	—	300	600	ns
	10	—	125	250	
	15	—	95	190	
Clock to Serial Output $Q_S^2$	5	—	230	460	ns
	10	—	110	220	
	15	—	75	150	
Clock to Parallel Output	5	—	420	840	ns
	10	—	195	390	
	15	—	135	270	
Strobe to Parallel Output	5	—	290	580	ns
	10	—	145	290	
	15	—	100	200	
Output Enable to Parallel Output: $t_{PHZ}, t_{PZH}$	5	—	140	280	ns
	10	—	60	120	
	15	—	45	90	
$t_{PLZ}, t_{PZL}$	5	—	100	200	ns
	10	—	50	100	
	15	—	40	80	
Minimum Strobe Pulse Width, $t_W$	5	—	100	200	ns
	10	—	40	80	
	15	—	35	70	
Minimum Clock Pulse Width, $t_W$	5	—	100	200	ns
	10	—	50	100	
	15	—	40	83	
Minimum Data Setup Time, $t_S$	5	—	60	125	ns
	10	—	30	55	
	15	—	20	35	
Transition Time; $t_{THL}, t_{TLH}$	5	—	100	200	ns
	10	—	50	100	
	15	—	40	80	
Maximum Clock Input Rise or Fall Time, $t_{rCL}, t_{fCL}$	5	15	—	—	$\mu\text{s}$
	10	5	—	—	
	15	5	—	—	
Maximum Clock Input Frequency, $f_{CL}$	5	1.25	2.5	—	MHz
	10	2.5	5	—	
	15	3	6	—	
Input Capacitance $C_{iN}$ (Any Input)	—	—	5	7.5	pF

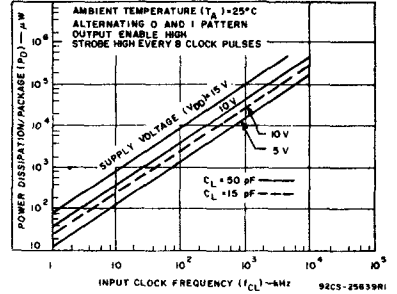

Fig. 16 - Dynamic power dissipation vs input clock frequency.

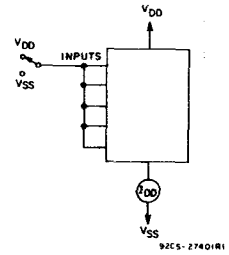

Fig. 17 - Quiescent device current test circuit.

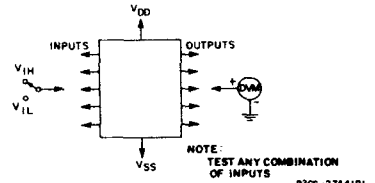

Fig. 18 - Input voltage test circuit.

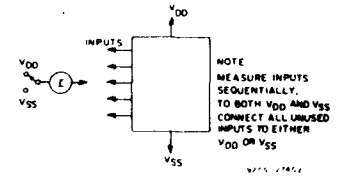
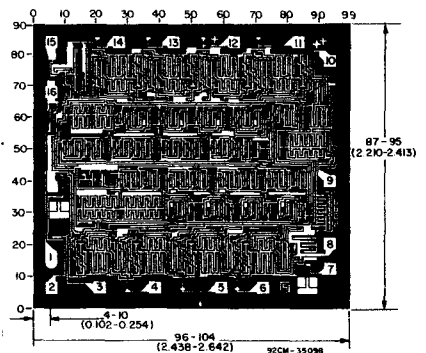

Fig. 19 - Input current test circuit.

The photographs and dimensions of each CMOS chip represent a chip when it is part of the wafer. When the wafer is separated into individual chips, the angle of cleavage may vary with respect to the chip face for different chips. The actual dimensions of the isolated chip, therefore, may differ slightly from the nominal dimensions shown. The user should consider a tolerance of  $-3\text{ mils}$  to  $+16\text{ mils}$  applicable to the nominal dimensions shown.

Dimensions in parentheses are in millimeters and are derived from the basic inch dimensions as indicated. Grid graduations are in mils ( $10^{-3}\text{ inch}$ ).



Dimensions and Pad Layout for CD4094B Chip.

# CD4095B, CD4096B Types

## CMOS Gated J-K Master-Slave Flip-Flops

With Set-Reset Capability  
High-Voltage Types (20-Volt Rating)

CD4095B Non-Inverting J and K Inputs  
CD4096B Inverting and Non-Inverting J and K Inputs

The RCA-CD4095B and CD4096B are J-K Master-Slave Flip-Flops featuring separate AND gating of multiple J and K inputs. The gated J-K inputs control transfer of information into the master section during clocked operation. Information on the J-K inputs is transferred to the Q and  $\bar{Q}$  outputs on the positive edge of the clock pulse. SET and RESET inputs (active high) are provided for asynchronous operation.

The CD4095B and CD4096B types are supplied in 14-lead hermetic dual-in-line ceramic packages (D and F suffixes), 14-lead dual-in-line plastic package (E suffix), 14-lead ceramic flat package (K suffix), and in chip form (H suffix).

### MAXIMUM RATINGS, Absolute-Maximum Values:

DC SUPPLY-VOLTAGE RANGE, (V <sub>DD</sub> ) (Voltages referenced to V <sub>SS</sub> Terminal)	-0.5 to +20 V
INPUT VOLTAGE RANGE, ALL INPUTS	-0.5 to V <sub>DD</sub> +0.5 V
DC INPUT CURRENT, ANY ONE INPUT	±10 mA
POWER DISSIPATION PER PACKAGE (P <sub>D</sub> ):	
For T <sub>A</sub> = -40 to +60°C (PACKAGE TYPE E)	500 mW
For T <sub>A</sub> = +60 to +85°C (PACKAGE TYPE E)	Derate Linearly at 12 mW/°C to 200 mW
For T <sub>A</sub> = -55 to +100°C (PACKAGE TYPES D, F, K)	500 mW
For T <sub>A</sub> = +100 to +125°C (PACKAGE TYPES D, F, K)	Derate Linearly at 12 mW/°C to 200 mW
DEVICE DISSIPATION PER OUTPUT TRANSISTOR	
For T <sub>A</sub> = FULL PACKAGE-TEMPERATURE RANGE (All Package Types)	100 mW
OPERATING-TEMPERATURE RANGE (T <sub>A</sub> ):	
PACKAGE TYPES D, F, K, H	-55 to +125°C
PACKAGE TYPE E	-40 to +85°C
STORAGE TEMPERATURE RANGE (T <sub>stg</sub> )	-65 to +150°C
LEAD TEMPERATURE (DURING SOLDERING):	
At distance 1/16 ± 1/32 inch (1.59 ± 0.79 mm) from case for 10 s max.	+265°C

### Features:

- 16 MHz toggle rate (typ.) at V<sub>DD</sub> - V<sub>SS</sub> = 10 V
- Gated inputs
- 100% tested for quiescent current at 20 V
- Maximum input current of 1 μA at 18 V over full package-temperature range; 100 nA at 18 V and 25°C
- Noise margin over full package-temperature range: 1 V at V<sub>DD</sub> = 5 V, 2 V at V<sub>DD</sub> = 10 V, 2.5 V at V<sub>DD</sub> = 15 V
- 5-V, 10-V, and 15-V parametric ratings
- Standardized, symmetrical output characteristics
- Meets all requirements of JEDEC Tentative Standard No. 13A, "Standard Specifications for Description of 'B' Series CMOS Devices"

### Applications:

- Registers
- Counters
- Control circuits

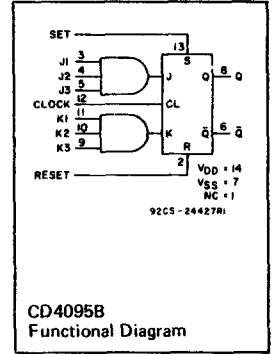

CD4095B  
Functional Diagram

### TRUTH TABLES SYNCHRONOUS OPERATION (S=0 R=0)

Inputs Before Positive Clock Transition		Outputs After Positive Clock Transition	
J*	K*	Q	$\bar{Q}$
0	0	No Change	
0	1	0	1
1	0	1	0
1	1	Toggles	

\* For CD4095B      For CD4096B  
J = J1 · J2 · J3      J = J1 · J2 · J3  
K = K1 · K2 · K3      K = K1 · K2 · K3

### ASYNCHRONOUS OPERATION (J and K - DON'T CARE)

S	R	Q	$\bar{Q}$
0	0	No Change	
0	1	0	1
1	0	1	0
1	1	0	0

0 = V<sub>SS</sub>, 1 = V<sub>DD</sub>

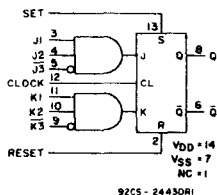

Fig. 1 - CD4096B Functional Diagram.

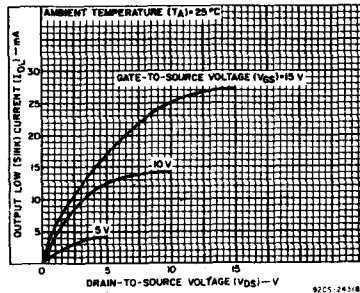

Fig. 2 - Typical output low (sink) current characteristics.

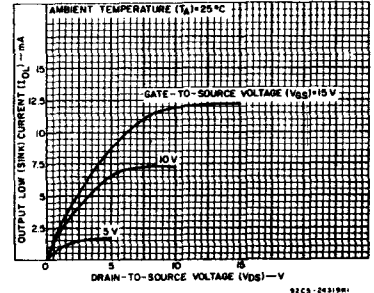

Fig. 3 - Minimum output low (sink) current characteristics.

# CD4095B, CD4096B Types

**RECOMMENDED OPERATING CONDITIONS** at  $T_A = 25^\circ\text{C}$ . Except as Noted.  
**For maximum reliability, nominal operating conditions should be selected so that operation is always within the following ranges:**

CHARACTERISTIC	$V_{DD}$ (V)	LIMITS		UNITS
		MIN.	MAX.	
Supply-Voltage Range (For $T_A =$ Full Package-Temperature Range)		3	18	V
Data Setup Time, $t_S$	5	400	—	ns
	10	160	—	
	15	100	—	
Clock Pulse Width, $t_W$	5	140	—	ns
	10	60	—	
	15	40	—	
Clock Input Frequency, $f_{CL}$	5	dc	3.5	MHz
	10	—	8	
	15	—	12	
Clock Rise and Fall Time, $t_{rCL}$ , $t_{fCL}$ :	5	—	15	$\mu\text{s}$
	10	—	5	
	15	—	5	
Set or Reset Pulse Width, $t_W$	5	200	—	ns
	10	100	—	
	15	50	—	

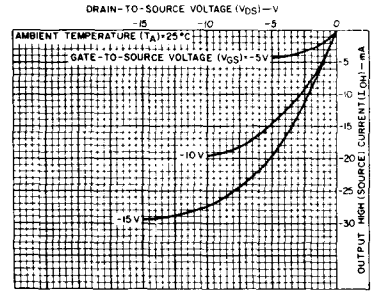

Fig. 4 — Typical output high (source) current characteristics.

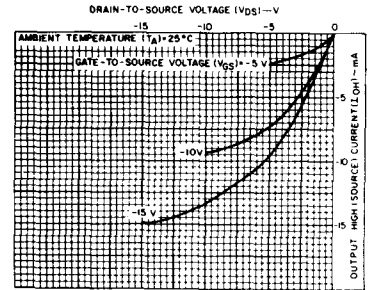

Fig. 5 — Minimum output high (source) current characteristics.

## STATIC ELECTRICAL CHARACTERISTICS

CHARACTERISTIC	CONDITIONS			LIMITS AT INDICATED TEMPERATURES ( $^{\circ}\text{C}$ )							UNITS		
				Values at $-55, +25, +125$ Apply to D, F, K, H Packages									
				Values at $-40, +25, +85$ Apply to E Package									
Quiescent Device Current, $I_{DD}$ Max.	$V_O$ (V)	$V_{IN}$ (V)	$V_{DD}$ (V)	-55			+25			Min.	Typ.	Max.	
				1	1	30	30	—	0.02				1
				2	2	60	60	—	0.02				2
				4	4	120	120	—	0.02				4
Output Low (Sink) Current $I_{OL}$ Min.	0.4	0.5	5	0.64	0.61	0.42	0.36	0.51	1	—	$\mu\text{A}$		
				10	1.6	1.5	1.1	0.9	1.3	2.6		—	
				15	4.2	4	2.8	2.4	3.4	6.8		—	
				20	20	20	600	600	—	0.04		20	
Output High (Source) Current, $I_{OH}$ Min.	4.6	0.5	5	-0.64	-0.61	-0.42	-0.36	-0.51	-1	—	mA		
				10	1.6	1.5	1.1	0.9	1.3	2.6		—	
				15	4.2	4	2.8	2.4	3.4	6.8		—	
				20	20	20	600	600	—	0.04		20	
Output Voltage: Low-Level, $V_{OL}$ Max.	—	0.5	5	0.05			—			0	0.05	V	
				0.05			—			0	0.05		
				0.05			—			0	0.05		
				0.05			—			0	0.05		
Output Voltage: High-Level, $V_{OH}$ Min.	—	0.5	5	4.95			4.95			5	—		
				9.95			9.95			10	—		
				9.95			9.95			10	—		
				14.95			14.95			15	—		
Input Low Voltage, $V_{IL}$ Max.	0.5, 4.5	—	5	1.5			—			1.5	V		
				3			—			3			
				4			—			4			
				11			11			—		—	
Input High Voltage, $V_{IH}$ Min.	0.5, 4.5	—	5	3.5			3.5			—	V		
				7			7			—			
				7			7			—			
				11			11			—			
Input Current $I_{IN}$ Max.	0.18	18	$\pm 0.1$	$\pm 0.1$	$\pm 1$	$\pm 1$	—	$\pm 10^{-5}$	$\pm 0.1$	$\mu\text{A}$			

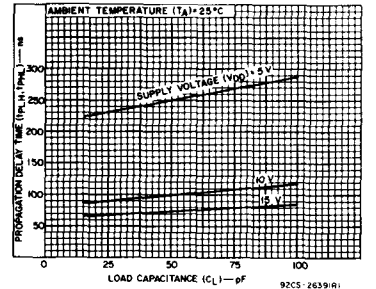

Fig. 6 — Typical propagation delay time vs. load capacitance.

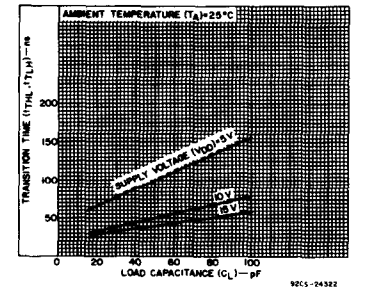

Fig. 7 — Typical transition time vs. load capacitance.

# CD4095B, CD4096B Types

DYNAMIC ELECTRICAL CHARACTERISTICS at  $T_A = 25^\circ\text{C}$ ; Input  $t_r, t_f = 20\text{ ns}$ ,  $C_L = 50\text{ pF}$ ,  $R_L = 200\text{ K}\Omega$

CHARACTERISTIC	TEST CONDITIONS	LIMITS			UNITS	
		$V_{DD}$ (V)	MIN.	TYP.		MAX.
Propagation Delay Time: $t_{pHL}, t_{pLH}$ Clock		5	—	250	500	ns
		10	—	100	200	
		15	—	75	150	
Set or Reset		5	—	150	300	ns
		10	—	75	150	
		15	—	50	100	
Transition Time, $t_{THL}, t_{TLH}$		5	—	100	200	ns
		10	—	50	100	
		15	—	40	80	
Maximum Clock Input Frequency, $(f_{CL})^*$		5	3.5	7	—	MHz
		10	8	16	—	
		15	12	24	—	
Minimum Clock Pulse Width, $t_W$		5	—	70	140	ns
		10	—	30	60	
		15	—	20	40	
Clock Input Rise or Fall Time, $t_{rcL}, t_{fcf}$		5	—	—	15	$\mu\text{s}$
		10	—	—	5	
		15	—	—	5	
Minimum Set or Reset Pulse Width, $t_W$		5	—	100	200	ns
		10	—	50	100	
		15	—	25	50	
Minimum Data Setup Time, $t_S$		5	—	200	400	ns
		10	—	80	160	
		15	—	50	100	
Input Capacitance, $C_{iN}$	Any Input	—	—	5	7.5	pF

\*  $t_r, t_f = 5\text{ ns}$

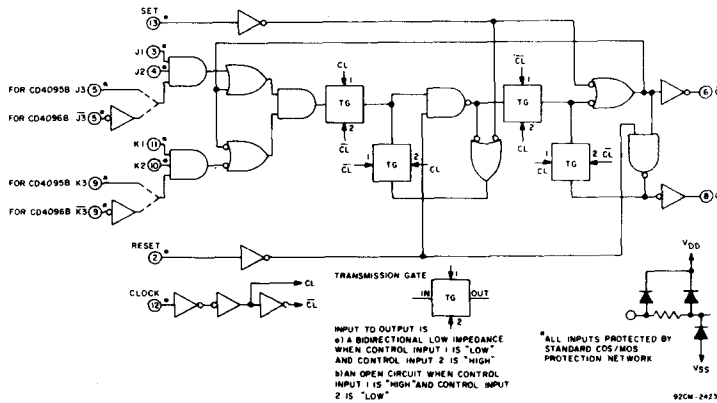

Fig. 11 — CD4095B and CD4096B logic diagram.

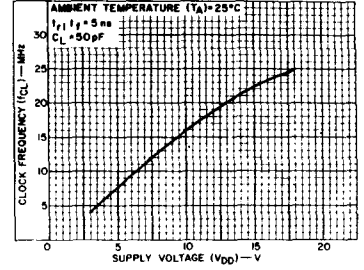

Fig. 8 — Typical clock frequency vs. supply voltage (toggle mode—see Fig. 16).

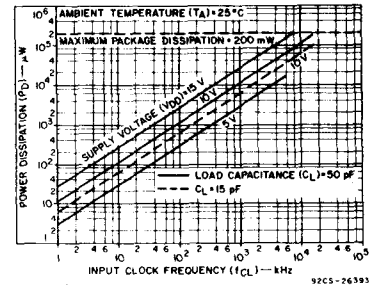

Fig. 9 — Typical power dissipation vs. input clock frequency.

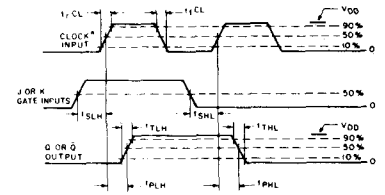

Fig. 10 — Propagation delay, transition, and setup-time waveforms.

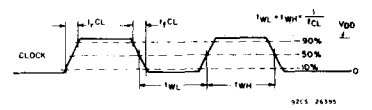

Fig. 12 — Clock pulse rise and fall time waveforms.

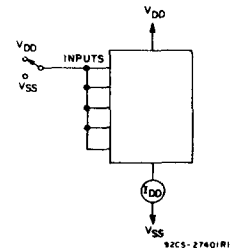

Fig. 13 — Quiescent device current test circuit.

# CD4095B, CD4096B Types

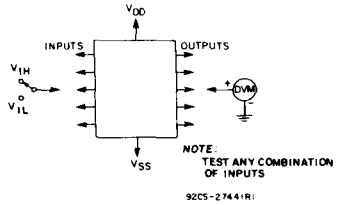

Fig. 14 - Input voltage test circuit.

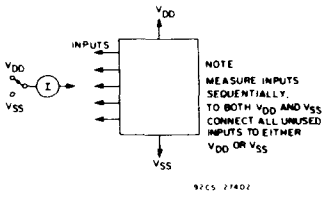

Fig. 15 - Input leakage current test circuit.

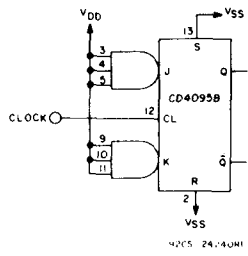

Fig. 16 - CD4095B connected in toggle mode.

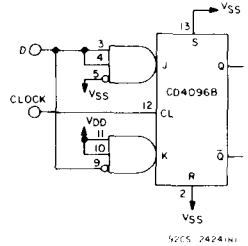

Fig. 17 - CD4096B connected as a "D" type flip-flop.

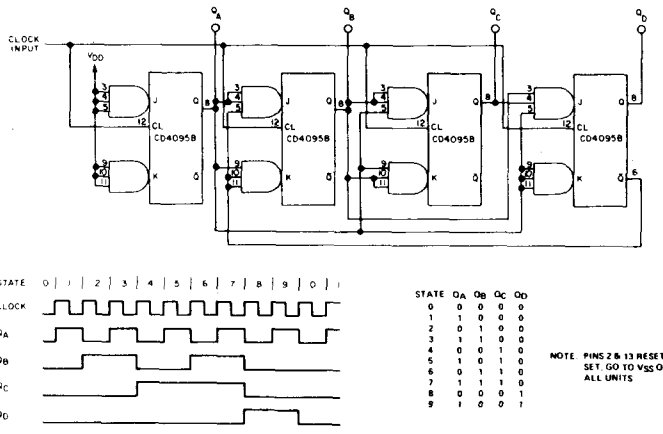
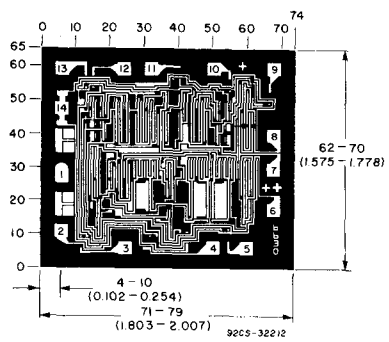

Fig. 18 - Synchronous binary divide-by-ten counter.

## DIMENSIONS AND PAD LAYOUT FOR CD4095B AND CD4096B



### CD4095BH

The photographs and dimensions of each CMOS chip represent a chip when it is part of the wafer. When the wafer is separated into individual chips, the angle of cleavage may vary with respect to the chip face for different chips. The actual dimensions of the isolated chip, therefore, may differ slightly from the nominal dimensions shown. The user should consider a tolerance of  $\pm 3$  mils to  $\pm 16$  mils applicable to the nominal dimensions shown.

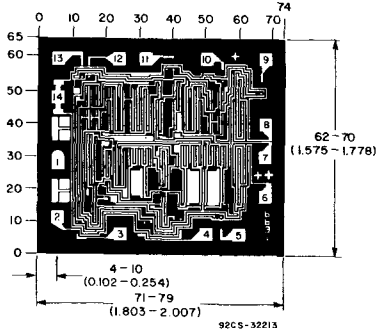

### CD4096BH

Dimensions in parentheses are in millimeters and are derived from the basic inch dimensions as indicated. Grid graduations are in mils ( $10^{-3}$  inch).

## TERMINAL ASSIGNMENTS

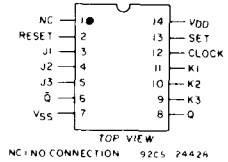

### CD4095B

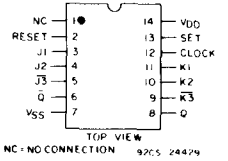

### CD4096B

## CD4098B Types

# CMOS Dual Monostable Multivibrator

High-Voltage Types (20-Volt Rating)

The RCA-CD4098B dual monostable multivibrator provides stable retriggerable/resettable one-shot operation for any fixed-voltage timing application.

An external resistor ( $R_X$ ) and an external capacitor ( $C_X$ ) control the timing for the circuit. Adjustment of  $R_X$  and  $C_X$  provides a wide range of output pulse widths from the Q and  $\bar{Q}$  terminals. The time delay from trigger input to output transition (trigger propagation delay) and the time delay from reset input to output transition (reset propagation delay) are independent of  $R_X$  and  $C_X$ .

Leading-edge-triggering (+TR) and trailing-edge-triggering (-TR) inputs are provided for triggering from either edge of an input pulse. An unused +TR input should be tied to  $V_{SS}$ . An unused -TR input should be tied to  $V_{DD}$ . A RESET (on low level) is provided for immediate termination of the output pulse or to prevent output pulses when power is turned on. An unused RESET input should be tied to  $V_{DD}$ . However, if an entire section of the CD4098B is not used, its RESET should be tied to  $V_{SS}$ . See Table I.

In normal operation the circuit triggers (extends the output pulse one period) on the application of each new trigger pulse. For operation in the non-retriggerable mode,  $\bar{Q}$  is connected to -TR when leading-edge triggering (+TR) is used or Q is connected to +TR when trailing-edge triggering (-TR) is used.

The time period (T) for this multivibrator can be approximated by:  $T_X = \frac{1}{2} R_X C_X$  for  $C_X \geq 0.01 \mu F$ . Time periods as a function of  $R_X$  for values of  $C_X$  and  $V_{DD}$  are given in Fig. 8. Values of T vary from unit to unit and as a function of voltage, temperature, and  $R_X C_X$ .

The minimum value of external resistance,  $R_X$ , is 5 k $\Omega$ . The maximum value of external capacitance,  $C_X$ , is 100  $\mu F$ . Fig. 9 shows time periods as a function of  $C_X$  for values of  $R_X$  and  $V_{DD}$ .

The output pulse width has variations of  $\pm 2.5\%$  typically, over the temperature range of  $-55^\circ C$  to  $125^\circ C$  for  $C_X = 1000 \text{ pF}$  and  $R_X = 100 \text{ k}\Omega$ .

For power supply variations of  $\pm 5\%$ , the output pulse width has variations of  $\pm 0.5\%$  typically, for  $V_{DD} = 10 \text{ V}$  and  $15 \text{ V}$  and  $\pm 1\%$  typically, for  $V_{DD} = 5 \text{ V}$  at  $C_X = 1000 \text{ pF}$  and  $R_X = 5 \text{ k}\Omega$ .

These types are supplied in 16-lead hermetic dual-in-line ceramic packages (D and F suffixes), 16-lead dual-in-line plastic package (E suffix), 16-lead ceramic flat packages (K suffix), and in chip form (H suffix).

The CD4098B is similar to type MC14528.

### Features:

- Retriggerable/resettable capability
- Trigger and reset propagation delays independent of  $R_X, C_X$
- Triggering from leading or trailing edge
- Q and  $\bar{Q}$  buffered outputs available
- Separate resets
- Wide range of output-pulse widths
- 100% tested for maximum quiescent current at 20 V
- Maximum input current of 1  $\mu A$  at 18 V over full package-temperature range; 100 nA at 18 V and  $25^\circ C$
- Noise margin (full package-temperature range): 1 V at  $V_{DD} = 5 \text{ V}$   
2 V at  $V_{DD} = 10 \text{ V}$   
2.5 V at  $V_{DD} = 15 \text{ V}$
- 5-V, 10-V, and 15-V parametric ratings
- Standardized, symmetrical output characteristics
- Meets all requirements of JEDEC Tentative Standard No. 13A, "Standard Specifications for Description of 'B' Series CMOS Devices."

### Applications:

- Pulse delay and timing
- Pulse shaping
- Astable multivibrator

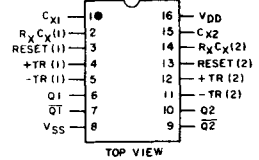
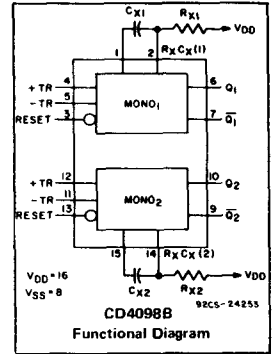

TERMINALS 1, 8, 15 ARE  
ELECTRICALLY CONNECTED  
INTERNALLY

92CS-24848R1

### TERMINAL ASSIGNMENT

### MAXIMUM RATINGS, Absolute-Maximum Values:

DC SUPPLY-VOLTAGE RANGE, ( $V_{DD}$ ) (Voltages referenced to $V_{SS}$ Terminal)	0.5 to +20 V
INPUT VOLTAGE RANGE, ALL INPUTS	0.5 to $V_{DD} + 0.5 \text{ V}$
DC INPUT CURRENT, ANY ONE INPUT	$\pm 10 \text{ mA}$
POWER DISSIPATION PER PACKAGE ( $P_D$ ):	
For $T_A = -40$ to $+60^\circ C$ (PACKAGE TYPE E)	500 mW
For $T_A = +60$ to $+85^\circ C$ (PACKAGE TYPE E)	Derate Linearly at 12 mW/ $^\circ C$ to 200 mW
For $T_A = -55$ to $+100^\circ C$ (PACKAGE TYPES D, F, K)	500 mW
For $T_A = +100$ to $+125^\circ C$ (PACKAGE TYPES D, F, K)	Derate Linearly at 12 mW/ $^\circ C$ to 200 mW
DEVICE DISSIPATION PER OUTPUT TRANSISTOR FOR $T_A =$ FULL PACKAGE TEMPERATURE RANGE (All Package Types)	100 mW
OPERATING TEMPERATURE RANGE ( $T_A$ ):	
PACKAGE TYPES D, F, K, H	55 to $+125^\circ C$
PACKAGE TYPE E	40 to $+85^\circ C$
STORAGE TEMPERATURE RANGE ( $T_{STG}$ )	65 to $+150^\circ C$
LEAD TEMPERATURE (DURING SOLDERING):	
At distance 1/16 $\pm$ 1/32 inch (1.59 $\pm$ 0.79 mm) from case for 10 s max.	$\pm 265^\circ C$

### RECOMMENDED OPERATING CONDITIONS

For maximum reliability, nominal operating conditions should be selected so that operation is always within the following ranges:

CHARACTERISTIC	$V_{DD}$ V	LIMITS		UNITS
		MIN.	MAX.	
Supply-Voltage Range (For $T_A =$ Full Package-Temperature Range)	—	3	18	V
Trigger Pulse Width $t_W$ (TR)	5 10 15	140 60 40	— — —	ns
Reset Pulse Width $t_W$ (R) (This is a function of $C_X$ )	—	See Dynamic Char. Chart and Fig. 10		—
Trigger Rise or Fall Time $t_r$ (TR), $t_f$ (TR)	5-15	—	100	$\mu s$



# CD4098B Types

TABLE I

CD4098B FUNCTIONAL TERMINAL CONNECTIONS

FUNCTION	V <sub>DD</sub> TO TERM. NO.		V <sub>SS</sub> TO TERM. NO.		INPUT PULSE TO TERM. NO.		OTHER CONNECTIONS	
	MONO <sub>1</sub>	MONO <sub>2</sub>	MONO <sub>1</sub>	MONO <sub>2</sub>	MONO <sub>1</sub>	MONO <sub>2</sub>	MONO <sub>1</sub>	MONO <sub>2</sub>
Leading-Edge Trigger/Retriggerable	3, 5	11, 13			4	12		
Leading-Edge Trigger/Non-retriggerable	3	13			4	12	5-7	11-9
Trailing-Edge Trigger/Retriggerable	3	13	4	12	5	11		
Trailing-Edge Trigger/Non-retriggerable	3	13			5	11	4-6	12-10
Unused Section	5	11	3, 4	12, 13				

NOTES:

1. A RETRIGGERABLE ONE-SHOT MULTIVIBRATOR HAS AN OUTPUT PULSE WIDTH WHICH IS EXTENDED ONE FULL TIME PERIOD (T<sub>X</sub>) AFTER APPLICATION OF THE LAST TRIGGER PULSE.  
The minimum time between retriggering edges (or trigger and retrigger edges) is 40 per cent of (T<sub>X</sub>).
2. A NON-RETRIGGERABLE ONE-SHOT MULTIVIBRATOR HAS A TIME PERIOD T<sub>X</sub> REFERENCED FROM THE APPLICATION OF THE FIRST TRIGGER PULSE.

INPUT PULSE TRAIN

RETRIGGERABLE MODE PULSE WIDTH (+TR MODE)

NON-RETRIGGERABLE MODE PULSE WIDTH (+TR MODE)

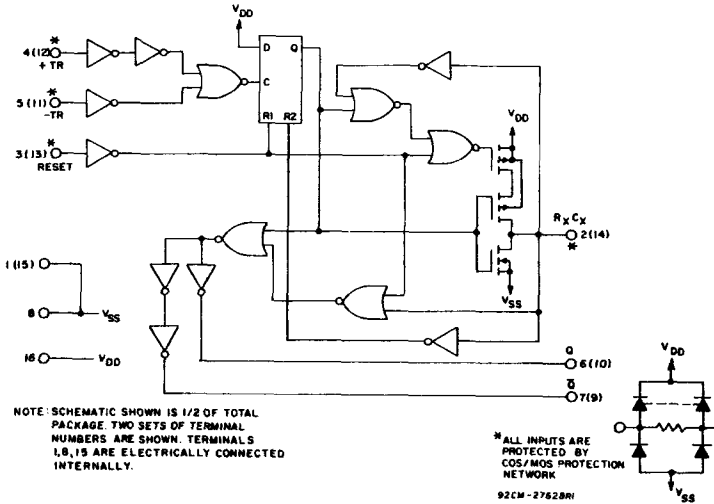
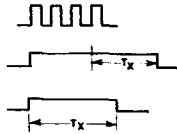

Fig. 4 - CD4098B logic diagram.

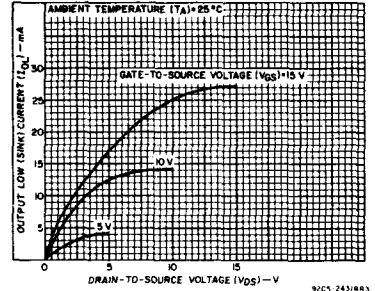

Fig. 1 - Typical output low (sink) current characteristics.

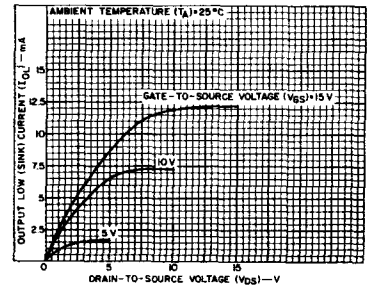

Fig. 2 - Minimum output low (sink) current characteristics.

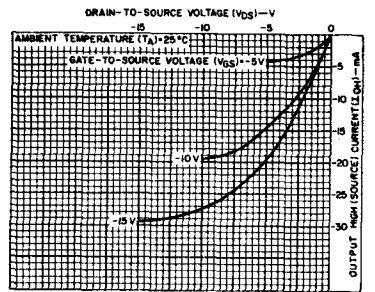

Fig. 3 - Typical output high (source) current characteristics.

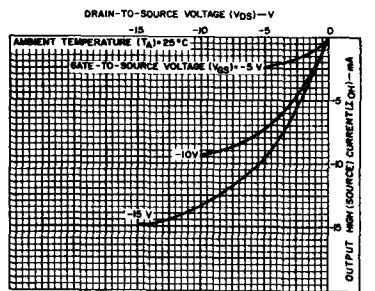

Fig. 5 - Minimum output high (source) current characteristics.

# CD4098B Types

## STATIC ELECTRICAL CHARACTERISTICS

CHARACTERISTIC	CONDITIONS			LIMITS AT INDICATED TEMPERATURES (°C)							UNITS
	V <sub>O</sub> (V)	V <sub>IN</sub> (V)	V <sub>DD</sub> (V)	Values at -55, +25, +125 Apply to D, F, K, H, pkgs.				Values at -40, +25, +85 Apply to E Pkgs.			
				-55	-40	+85	+125	+25			
								Min.	Typ.	Max.	
Quiescent Device Current I <sub>DD</sub> Max.	—	0,5	5	1	1	30	30	—	0.02	1	μA
Output Low (Sink) Current, I <sub>OL</sub> Min.	0,4	0,5	5	0,64	0,61	0,42	0,36	0,51	1	—	mA
Output High (Source) Current, I <sub>OH</sub> Min.	0,5	0,10	10	1,6	1,5	1,1	0,9	1,3	2,6	—	
Output Voltage: Low-Level, V <sub>OL</sub> Max.	1,5	0,15	15	4,2	4	2,8	2,4	3,4	6,8	—	
Output Voltage: High-Level, V <sub>OH</sub> Min.	4,6	0,5	5	-0,64	-0,61	-0,42	-0,36	-0,51	-1	—	V
Output Voltage: Low-Level, V <sub>OL</sub> Max.	2,5	0,5	5	-2	-1,8	-1,3	-1,15	-1,6	-3,2	—	
Output Voltage: High-Level, V <sub>OH</sub> Min.	9,5	0,10	10	-1,6	-1,5	-1,1	-0,9	-1,3	-2,6	—	
Input Low Voltage, V <sub>IL</sub> Max.	—	0,5	5	—	—	—	—	—	0	0,05	V
Input High Voltage, V <sub>IH</sub> Min.	—	0,10	10	—	—	—	—	—	0	0,05	
Input Current, I <sub>IN</sub> Max.	—	0,15	15	—	—	—	—	—	0	0,05	
Input Low Voltage, V <sub>IL</sub> Max.	0,5,4,5	—	5	—	—	1,5	—	—	—	1,5	V
Input High Voltage, V <sub>IH</sub> Min.	1,9	—	10	—	—	3	—	—	—	3	
Input Current, I <sub>IN</sub> Max.	1,5,13,5	—	15	—	—	4	—	—	—	4	
Input High Voltage, V <sub>IH</sub> Min.	0,5,4,5	—	5	—	—	3,5	—	—	—	—	μA
Output Leakage I <sub>OUT</sub> Max.	—	—	—	—	—	—	—	—	—	—	
Output Leakage I <sub>OUT</sub> Max.	—	—	—	—	—	—	—	—	—	—	
Input Current, I <sub>IN</sub> Max.	—	0,18	18	±0,1	±0,1	±1	±1	—	±10 <sup>-5</sup>	±0,1	μA
Output Leakage I <sub>OUT</sub> Max.	0,18	0,18	18	±0,4	±0,4	±12	±12	—	±10 <sup>-4</sup>	±0,4	μA

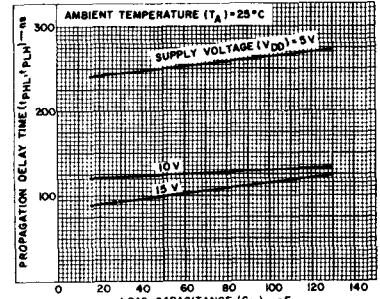

Fig. 6 - Typical propagation delay time vs. load capacitance, trigger into Q out. (All values of C<sub>X</sub> and R<sub>X</sub>)

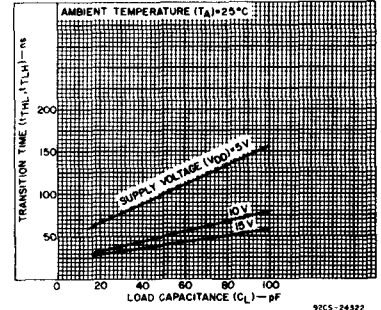

Fig. 7 - Transition time vs. load capacitance for R<sub>X</sub> = 5 kΩ-10000 kΩ and C<sub>X</sub> = 15 pF-10000 pF.

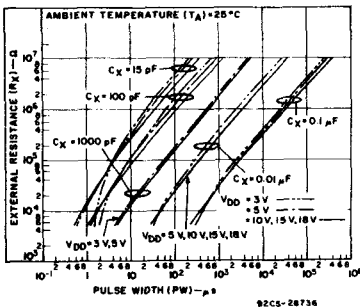

Fig. 8 - Typical external resistance vs. pulse width.

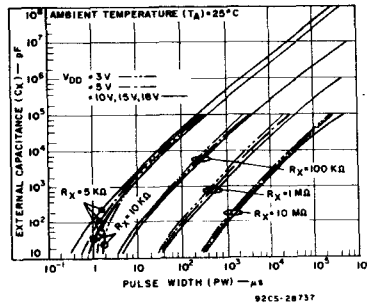

Fig. 9 - Typical external capacitance vs. pulse width.

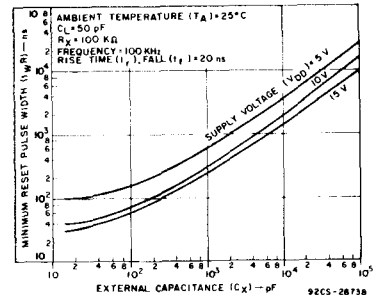

Fig. 10 - Typical minimum reset pulse width vs. external capacitance.

# CD4098B Types

## DYNAMIC ELECTRICAL CHARACTERISTICS

At  $T_A = 25^\circ\text{C}$ ; Input  $t_r, t_f = 20\text{ ns}$ ,  $C_L = 50\text{ pF}$ ,  $R_L = 200\text{ k}\Omega$

CHARACTERISTIC	TEST CONDITIONS			LIMITS		UNITS
	$R_X$ (k $\Omega$ )	$C_X$ (pF)	$V_{DD}$ (V)	Typ.	Max.	
Trigger Propagation Delay Time $+TR, -TR$ to Q, $\bar{Q}$ $t_{PHL}, t_{PLH}$	5 to 10,000	$\geq 15$	5	250	500	ns
			10	125	250	
			15	100	200	
Minimum Trigger Pulse Width, $t_{WH}, t_{WL}$	5 to 10,000	$\geq 15$	5	70	140	ns
			10	30	60	
			15	20	40	
Transition Time, $t_{TLH}$	5 to 10,000	$\geq 15$	5	100	200	ns
			10	50	100	
			15	40	80	
	5 to 10,000	15 to 10,000	5	100	200	
			10	50	100	
			15	40	80	
	5 to 10,000	0.01 $\mu\text{F}$ to 0.1 $\mu\text{F}$	5	150	300	
			10	75	150	
			15	65	130	
5 to 10,000	0.1 $\mu\text{F}$ to 1 $\mu\text{F}$	5	250	500		
		10	150	300		
		15	80	160		
Reset Propagation Delay Time, $T_{PHL}, T_{PLH}$	5 to 10,000	$\geq 15$	5	225	450	ns
			10	125	250	
			15	75	150	
Minimum Reset Pulse Width, $t_{WR}$	100	15	5	100	200	ns
			10	40	80	
			15	30	60	
		5	1000	5	600	1200
				10	300	600
				15	250	500
		0.1 $\mu\text{F}$	5	25	50	$\mu\text{s}$
			10	15	30	
			15	10	20	
Trigger Rise or Fall Time $t_r$ (TR), $t_f$ (TR)	-	-	5 to 15	-	100	$\mu\text{s}$
			-	-	-	
Pulse Width Match Between Circuits in Same Package	10	10,000	5	5	10	%
			10	7.5	15	
			15	7.5	15	
Input Capacitance, $C_{IN}$	Any Input			5	7.5	pF

## TEST CIRCUITS

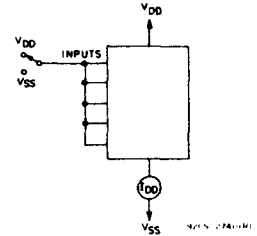
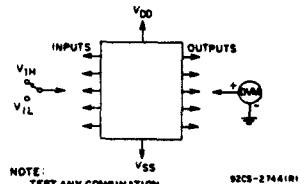

Fig. 12 - Quiescent-device-current test circuits.



NOTE: TEST ANY COMBINATION OF INPUTS

Fig. 13 - Input-voltage test circuit.

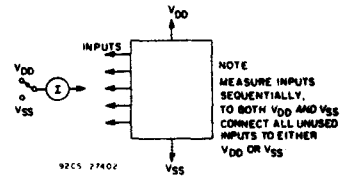
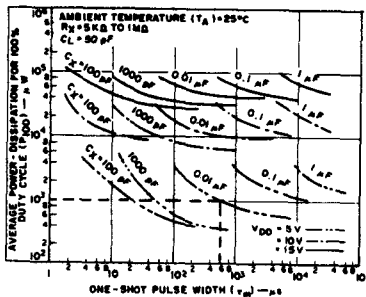
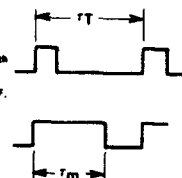

Fig. 14 - Input leakage current test circuit.



To calculate average power dissipation (P) for less than 100% duty cycle  
 $P_{100}$  = average power for 100% duty cycle  
 $P = \left(\frac{t_m}{T}\right) P_{100}$  where  $t_m$  = one-shot pulse width  
 $T$  = trigger pulse period

e.g. For  $t_m = 500\text{ }\mu\text{s}$ ,  $T = 1000\text{ }\mu\text{s}$ ,  $C_L = 0.01\text{ }\mu\text{F}$ ,  
 $V_{DD} = 5\text{ V}$   
 $P = \left(\frac{500}{1000}\right) 10^3\text{ }\mu\text{W} = 500\text{ }\mu\text{W}$  (see dotted line on graph)



92CM-28738

Fig. 11 - Average power dissipation vs. one-shot pulse width.

# CD4098B Types

## APPLICATIONS

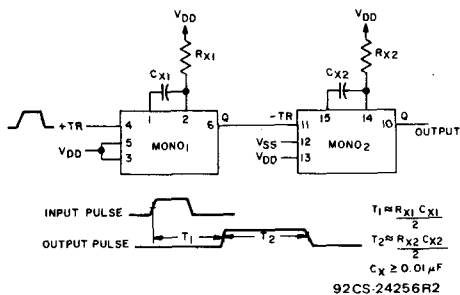

Fig. 15 - Pulse delay.

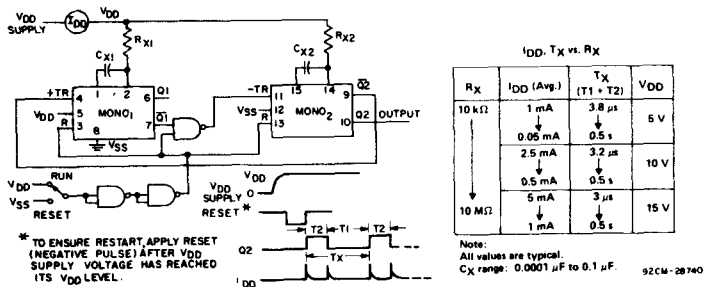
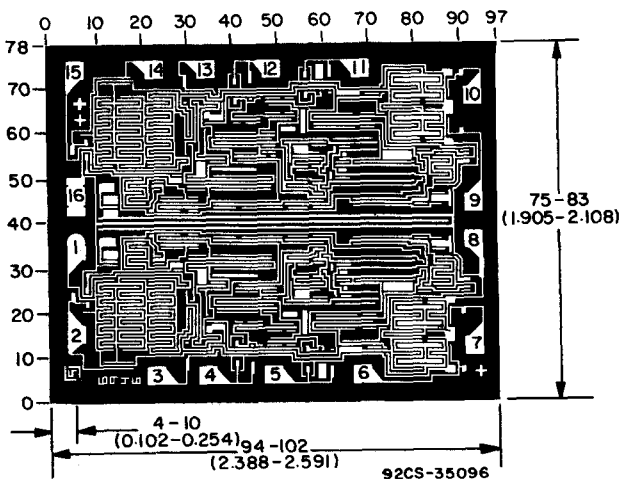

Fig. 16 - Astable multivibrator with restart after reset capability.



### Dimensions and Pad Layout for CD4098BH

Dimensions in parentheses are in millimeters and are derived from the basic inch dimensions as indicated. Grid graduations are in mils (10<sup>-3</sup> inch).

The photographs and dimensions of each CMOS chip represent a chip when it is part of the wafer. When the wafer is separated into individual chips, the angle of cleavage may vary with respect to the chip face for different chips. The actual dimensions of the isolated chip, therefore, may differ slightly from the nominal dimensions shown. The user should consider a tolerance of -3 mils to +16 mils applicable to the nominal dimensions shown.

# CMOS 8-Bit Addressable Latch

High-Voltage Types (20-Volt Rating)

The RCA-CD4099B 8-bit addressable latch is a serial-input, parallel-output storage register that can perform a variety of functions.

Data are inputted to a particular bit in the latch when that bit is addressed (by means of inputs A0, A1, A2) and when WRITE DISABLE is at a low level. When WRITE DISABLE is high, data entry is inhibited; however, all 8 outputs can be continuously read independent of WRITE DISABLE and address inputs.

A master RESET input is available, which resets all bits to a logic "0" level when RESET and WRITE DISABLE are at a high level. When RESET is at a high level, and WRITE DISABLE is at a low level, the latch acts as a 1-of-8 demultiplexer; the bit that is addressed has an active output which follows the data input, while all unaddressed bits are held to a logic "0" level.

The CD4099B types are supplied in 16-lead hermetic ceramic dual-in-line packages (D and F suffixes), 16-lead plastic dual-in-line packages (E suffix), 16-lead ceramic flat packages (K suffix), and in chip form (H suffix).

**Features:**

- Serial data input    ■ Active parallel output
- Storage register capability    ■ Master clear
- Can function as demultiplexer
- Standardized, symmetrical output characteristics
- 100% tested for quiescent current at 20 V
- Maximum input current of 1  $\mu$ A at 18 V (full package-temperature range), 100 nA at 18 V and 25°C
- Noise margin (full package-temperature range) = 1 V at  $V_{DD} = 5$  V, 2 V at  $V_{DD} = 10$  V, 2.5 V at  $V_{DD} = 15$  V
- 5-V, 10-V, and 15-V parametric ratings
- Meets all requirements of JEDEC Tentative Standard No. 13A, "Standard Specifications for Description of 'B' Series CMOS Devices"

**Applications:**

- Multi-line decoders
- A/D converters

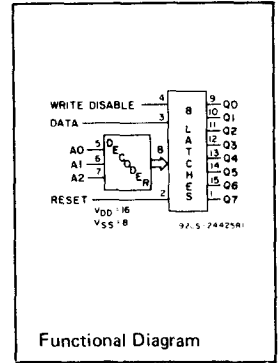

**MAXIMUM RATINGS, Absolute-Maximum Values:**

DC SUPPLY-VOLTAGE RANGE, ( $V_{DD}$ ) (Voltages referenced to $V_{SS}$ Terminal)	-0.5 to +20 V
INPUT VOLTAGE RANGE, ALL INPUTS	-0.5 to $V_{DD} + 0.5$ V
DC INPUT CURRENT, ANY ONE INPUT	$\pm 10$ mA
POWER DISSIPATION PER PACKAGE ( $P_D$ ):	
For $T_A = -40$ to $+60^\circ\text{C}$ (PACKAGE TYPE E)	500 mW
For $T_A = +60$ to $+85^\circ\text{C}$ (PACKAGE TYPE E)	Derate Linearly at 12 mW/ $^\circ\text{C}$ to 200 mW
For $T_A = -55$ to $+100^\circ\text{C}$ (PACKAGE TYPES D, F, K)	500 mW
For $T_A = +100$ to $+125^\circ\text{C}$ (PACKAGE TYPES D, F, K)	Derate Linearly at 12 mW/ $^\circ\text{C}$ to 200 mW
DEVICE DISSIPATION PER OUTPUT TRANSISTOR FOR $T_A = \text{FULL PACKAGE-TEMPERATURE RANGE}$ (All Package Types)	100 mW
OPERATING-TEMPERATURE RANGE ( $T_A$ ):	
PACKAGE TYPES D, F, K, H	-55 to $+125^\circ\text{C}$
PACKAGE TYPE E	-40 to $+85^\circ\text{C}$
STORAGE TEMPERATURE RANGE ( $T_{STG}$ )	-65 to $+150^\circ\text{C}$
LEAD TEMPERATURE (DURING SOLDERING):	
At distance 1/16 $\pm$ 1/32 inch (1.59 $\pm$ 0.79 mm) from case for 10 s max.	$+265^\circ\text{C}$

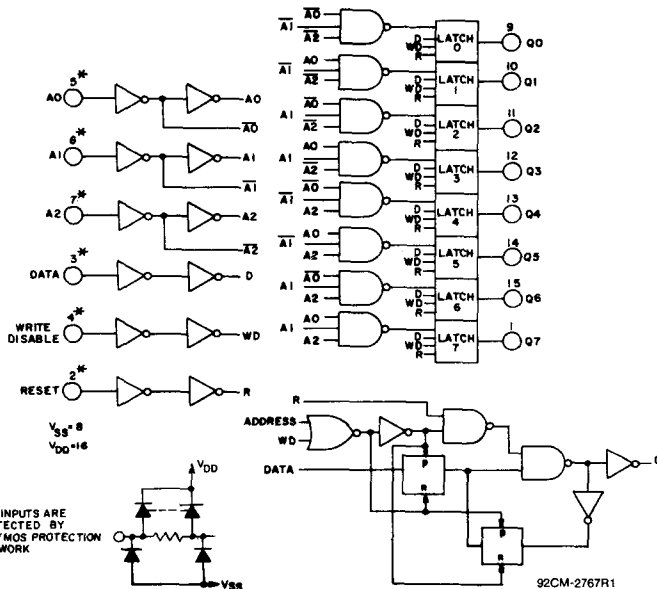
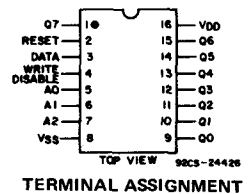

Fig. 1 - Logic diagram of CD4099B and detail of 1 of 8 latches.



TOP VIEW 92CS-2442B

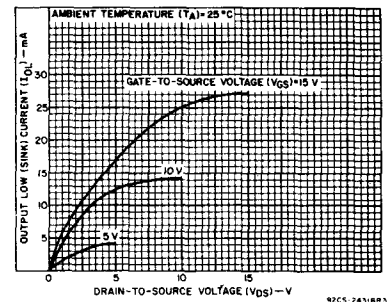

Fig. 2 - Typical output low (sink) current characteristics.

# CD4099B Types

**RECOMMENDED OPERATING CONDITIONS** at  $T_A = 25^\circ\text{C}$  (Unless otherwise specified)  
 For maximum reliability, nominal operating conditions should be selected so that operation is always within the following ranges.

CHARACTERISTIC	SEE FIG. 15*	$V_{DD}$ (V)	LIMITS		UNITS
			MIN.	MAX.	
Supply Voltage Range: (At $T_A =$ Full Package Temperature Range)			3	18	V
Minimum Pulse Width, $t_W$ Data	4	5	200	—	ns
		10	100	—	
		15	80	—	
Address	8	5	400	—	ns
		10	200	—	
		15	125	—	
Reset	5	5	150	—	ns
		10	75	—	
		15	50	—	
Setup Time, $t_S$ Data to WRITE DISABLE	6	5	100	—	ns
		10	50	—	
		15	35	—	
Hold Time, $t_H$ Data to WRITE DISABLE	7	5	150	—	ns
		10	75	—	
		15	50	—	

\* Circled numbers refer to times indicated on master timing diagram.

Note: In addition to the above characteristics, a WRITE DISABLE ON time (the time that WRITE DISABLE is at a high level) must be observed during an address change for the total time that the external address lines A0, A1, and A2 are settling to a stable level, to prevent a wrong cell from being addressed (see Fig. 3).

MODE SELECTION			
WD	R	ADDRESSED LATCH	UNADDRESSED LATCH
0	0	Follows Data	Holds Previous State
0	1	Follows Data (Active High 8-Channel Demultiplexer)	Reset to "0"
1	0	Holds Previous State	Reset to "0"
1	1	Reset to "0"	Reset to "0"

WD = WRITE DISABLE

R = RESET

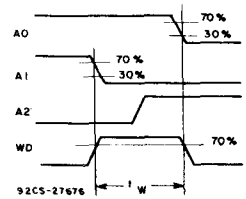

Fig. 3 — Definition of WRITE DISABLE ON time.

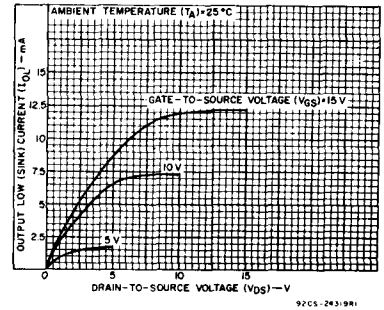

Fig. 4 — Minimum output low (sink) current characteristics.

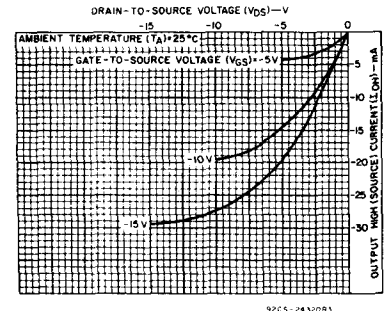

Fig. 6 — Typical output high (source) current characteristics.

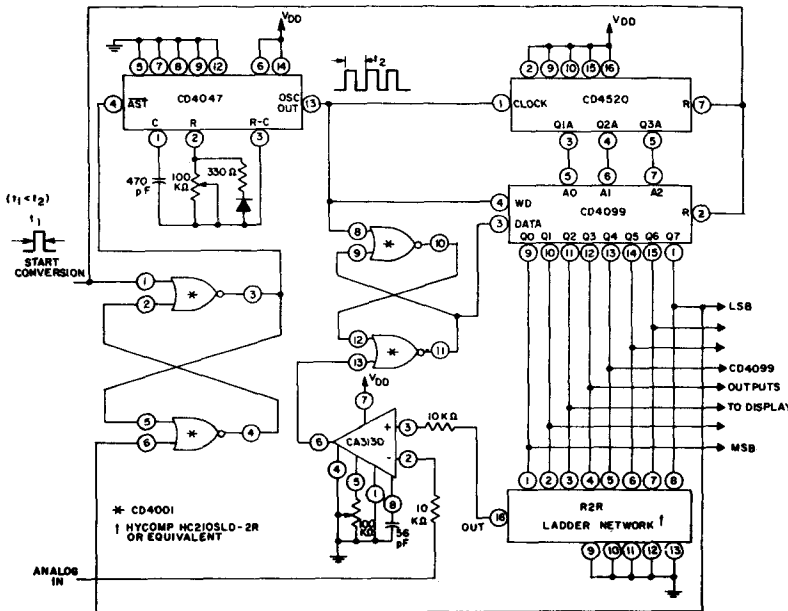

Fig. 5 — A/D converter

92CL-27481

# CD4099B Types

## STATIC ELECTRICAL CHARACTERISTICS

CHARACTERISTIC	CONDITIONS			LIMITS AT INDICATED TEMPERATURES (°C)							UNITS
	V <sub>O</sub> (V)	V <sub>IN</sub> (V)	V <sub>DD</sub> (V)	Values at -55, +25, +125 Apply to D,F,K,H Packages Values at -40, +25, +85 Apply to E Package							
				-55	-40	+85	+125	+25			
				Min.	Typ.	Max.					
Quiescent Device Current, I <sub>DD</sub> Max.	-	0,5	5	5	5	150	150	-	0,04	5	μA
	-	0,10	10	10	10	300	300	-	0,04	10	
	-	0,15	15	20	20	600	600	-	0,04	20	
	-	0,20	20	100	100	3000	3000	-	0,08	100	
Output Low (Sink) Current I <sub>OL</sub> Min.	0,4	0,5	5	0,64	0,61	0,42	0,36	0,51	1	-	mA
	0,5	0,10	10	1,6	1,5	1,1	0,9	1,3	2,6	-	
	1,5	0,15	15	4,2	4	2,8	2,4	3,4	6,8	-	
Output High (Source) Current, I <sub>OH</sub> Min.	4,6	0,5	5	-0,64	-0,61	-0,42	-0,36	-0,51	-1	-	mA
	2,5	0,5	5	-2	-1,8	-1,3	-1,15	-1,6	-3,2	-	
	9,5	0,10	10	-1,6	-1,5	-1,1	-0,9	-1,3	-2,6	-	
Output Voltage: Low-Level, V <sub>OL</sub> Max.	-	0,5	5	0,05			-	0	0,05	-	V
	-	0,10	10	0,05			-	0	0,05	-	
	-	0,15	15	0,05			-	0	0,05	-	
Output Voltage: High-Level, V <sub>OH</sub> Min.	-	0,5	5	4,95			4,95	5	-	-	V
	-	0,10	10	9,95			9,95	10	-	-	
	-	0,15	15	14,95			14,95	15	-	-	
Input Low Voltage, V <sub>IL</sub> Max.	0,5, 4,5	-	5	1,5			-	-	1,5	-	V
	1,9	-	10	3			-	-	3	-	
	1,5, 13,5	-	15	4			-	-	4	-	
Input High Voltage, V <sub>IH</sub> Min.	0,5, 4,5	-	5	3,5			3,5	-	-	-	V
	1,9	-	10	7			7	-	-	-	
	1,5, 13,5	-	15	11			11	-	-	-	
Input Current I <sub>IN</sub> Max.	-	0,18	18	±0,1	±0,1	±1	±1	-	±10 <sup>-5</sup>	±0,1	μA

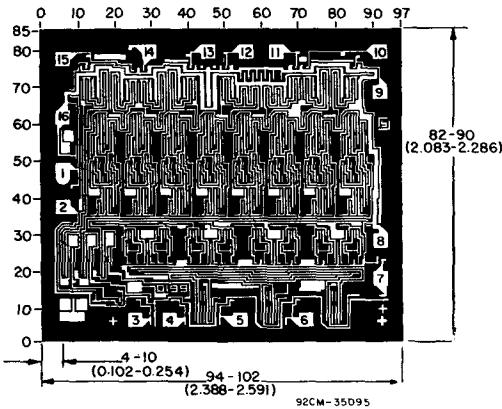

### CD4099BH DIMENSIONS AND PAD LAYOUT

Dimensions in parentheses are in millimeters and are derived from the basic inch dimensions as indicated. Grid graduations are in mils (10<sup>-3</sup> inch).

The photographs and dimensions of each CMOS chip represent a chip when it is part of the wafer. When the wafer is separated into individual chips, the angle of cleavage may vary with respect to the chip face for different chips. The actual dimensions of the isolated chip, therefore, may differ slightly from the nominal dimensions shown. The user should consider a tolerance of -3 mils to +16 mils applicable to the nominal dimensions shown.

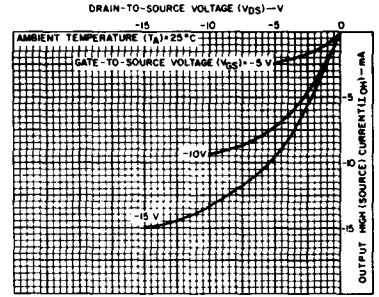

Fig. 7 - Minimum output high (source) current characteristics.

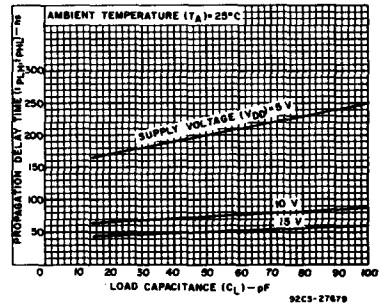

Fig. 8 - Typical propagation delay time (data to Q<sub>n</sub>) vs. load capacitance.

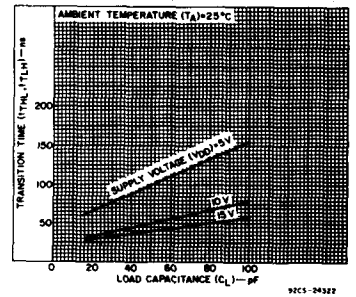

Fig. 9 - Typical transition time vs. load capacitance.

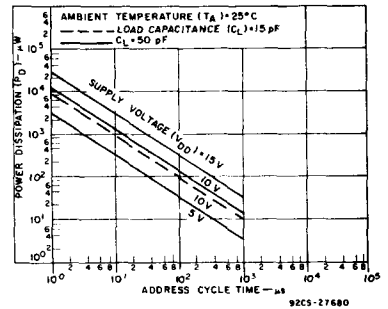

Fig. 10 - Typical dynamic power dissipation vs. address cycle time.

# CD4099B Types

**DYNAMIC ELECTRICAL CHARACTERISTICS at  $T_A = 25^\circ\text{C}$ ,  $C_L = 50\text{ pF}$ ,  
Input  $t_r, t_f = 20\text{ ns}$ ,  $R_L = 200\text{ K}\Omega$**

CHARACTERISTIC	CONDITIONS		LIMITS		UNITS
	SEE	V <sub>DD</sub>	ALL PACKAGE TYPES		
	FIG. 15*	(V)	TYP.	MAX.	
Propagation Delay: $t_{PLH}$ , $t_{PHL}$	①	5	200	400	ns
		10	75	150	
		15	50	100	
Data to Output, WRITE DISABLE to Output, $t_{PLH}$ , $t_{PHL}$	②	5	200	400	
		10	80	160	
		15	60	120	
Reset to Output, $t_{PHL}$	③	5	175	350	
		10	80	160	
		15	65	130	
Address to Output, $t_{PLH}$ , $t_{PHL}$	⑨	5	225	450	
		10	100	200	
		15	75	150	
Transition Time, (Any Output) $t_{THL}$ , $t_{TLH}$		5	100	200	ns
		10	50	100	
		15	40	80	
Minimum Pulse Width, $t_W$ Data	④	5	100	200	ns
		10	50	100	
		15	40	80	
Address	⑧	5	200	400	ns
		10	100	200	
		15	65	125	
Reset	⑤	5	75	150	ns
		10	40	75	
		15	25	50	
Minimum Setup Time, $t_S$ Data to WRITE DISABLE	⑥	5	50	100	ns
		10	25	50	
		15	20	35	
Minimum Hold Time, $t_H$ Data to WRITE DISABLE	⑦	5	75	150	ns
		10	40	75	
		15	25	50	
Input Capacitance, $C_{IN}$	Any Input		5	7.5	pF

\*Circled numbers refer to times indicated on master timing diagram.

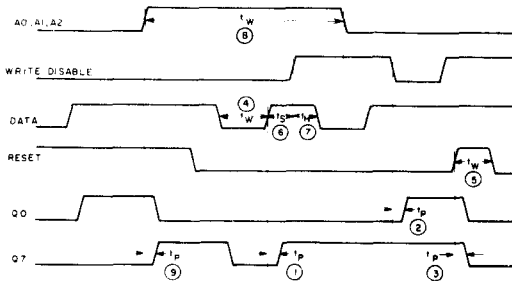

Fig. 15 - Master timing diagram.

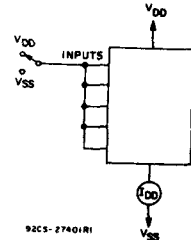

Fig. 11 - Quiescent device current test circuit.

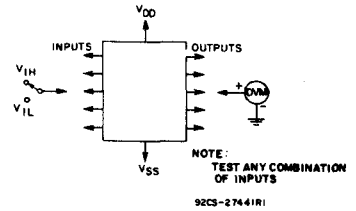

Fig. 12 - Input voltage test circuit.

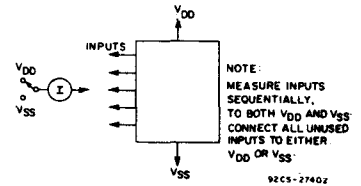

Fig. 13 - Input current test circuit.

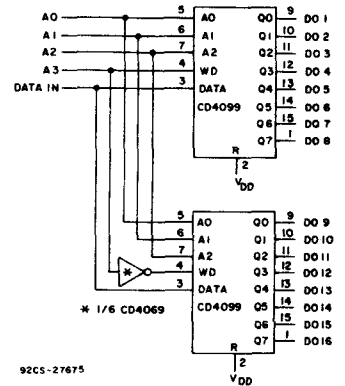

Fig. 14 - 1 of 16 decoder/demultiplexer.

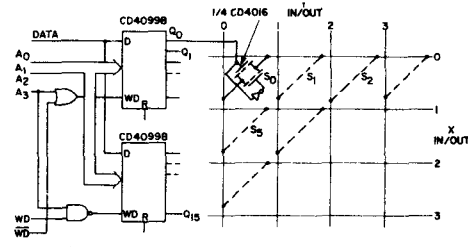

Fig. 16 - Multiple selection decoding - 4 x 4 crosspoint switch.



# CMOS Strobed Hex Inverter/Buffer

High-Voltage Types (20-Volt Rating)

The RCA-CD4502B consists of six inverter/buffers with 3-state outputs. A logic "1" on the OUTPUT DISABLE input produces a high-impedance state in all six outputs. This feature permits common bussing of the outputs, thus simplifying system design. A Logic "1" on the INHIBIT input switches all six outputs to logic "0" if the OUTPUT DISABLE input is a logic "0". This device is capable of driving two standard TTL loads, which is equivalent to six times the JEDEC "B"-series  $I_{OL}$  standard.

The CD4502B types are supplied in 16-lead hermetic dual-in-line ceramic packages (D and F suffixes), 16-lead dual-in-line plastic package (E suffix), 16-lead ceramic flat package (K suffix), and in chip form (H suffix). This device is similar to the MC14502.

**Features:**

- 2 TTL-load output drive capability
- 3-state outputs
- Common output-disable control
- Inhibit control
- 100% tested for quiescent current at 20 V
- 5-V, 10-V, and 15-V parametric ratings
- Maximum input current of 1  $\mu$ A at 18 V over full package-temperature range; 100 nA at 18 V and 25°C
- Meets all requirements of JEDEC Tentative Standard No. 13A, "Standard Specifications for Description of 'B' Series CMOS Devices"
- Noise margin (full package-temperature range) =

1 V at  $V_{DD} = 5$  V  
 2 V at  $V_{DD} = 10$  V  
 2.5 V at  $V_{DD} = 15$  V

**Applications:**

- 3-state hex inverter for interfacing IC's with data buses
- COS/MOS to TTL hex buffer

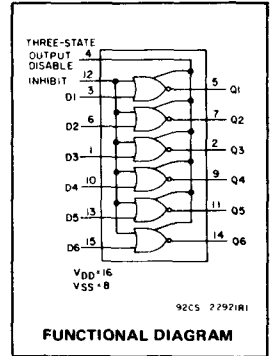

**MAXIMUM RATINGS, Absolute-Maximum Values:**

DC SUPPLY-VOLTAGE RANGE, ( $V_{DD}$ )		-0.5 to +20 V
(Voltages referenced to $V_{SS}$ Terminal)		
INPUT VOLTAGE RANGE, ALL INPUTS		-0.5 to $V_{DD} + 0.5$ V
DC INPUT CURRENT, ANY ONE INPUT		$\pm 10$ $\mu$ A
POWER DISSIPATION PER PACKAGE ( $P_D$ ):		
For $T_A = -40$ to $+60^\circ\text{C}$ (PACKAGE TYPE E)		500 mW
For $T_A = +60$ to $+85^\circ\text{C}$ (PACKAGE TYPE E)		Derate Linearly at 12 mW/ $^\circ\text{C}$ to 200 mW
For $T_A = -55$ to $+100^\circ\text{C}$ (PACKAGE TYPES D, F, K)		500 mW
For $T_A = +100$ to $+125^\circ\text{C}$ (PACKAGE TYPES D, F, K)		Derate Linearly at 12 mW/ $^\circ\text{C}$ to 200 mW
DEVICE DISSIPATION PER OUTPUT TRANSISTOR		
FOR $T_A =$ FULL PACKAGE-TEMPERATURE RANGE (All Package Types)		100 mW
OPERATING-TEMPERATURE RANGE ( $T_A$ ):		
PACKAGE TYPES D, F, K, H		-55 to $+125^\circ\text{C}$
PACKAGE TYPE E		-40 to $+85^\circ\text{C}$
STORAGE TEMPERATURE RANGE ( $T_{stg}$ )		-65 to $+150^\circ\text{C}$
LEAD TEMPERATURE (DURING SOLDERING):		
At distance $1/16 \pm 1/32$ inch ( $1.59 \pm 0.79$ mm) from case for 10 s max.		$+265^\circ\text{C}$

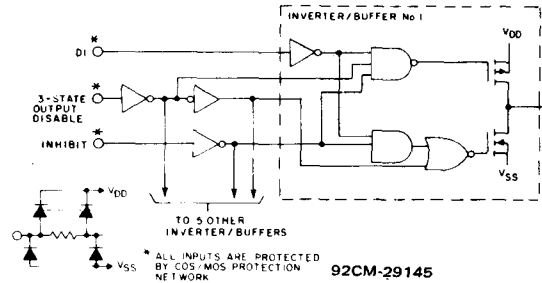
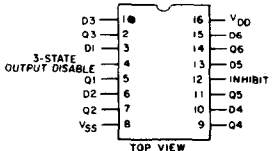

Fig.1 - Logic diagram of 1 of 6 identical inverter/buffers.

**TRUTH TABLE**

DISABLE	INHIBIT	$D_n$	$Q_n$
0	0	0	1
0	0	1	0
0	1	X	0
1	X	X	Z

Logic 0 = Low  
 Z = High Impedance  
 X = Don't Care  
 Logic 1 = High



TERMINAL ASSIGNMENT

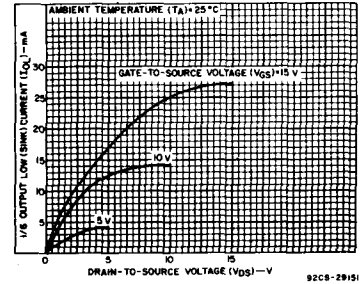

Fig.2 - Typical output low (sink) current characteristics.

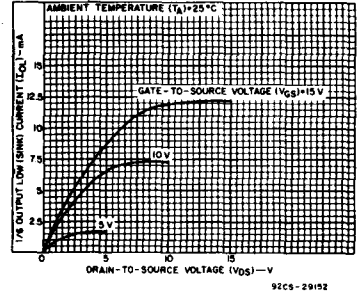

Fig.3 - Minimum output low (sink) current characteristics.

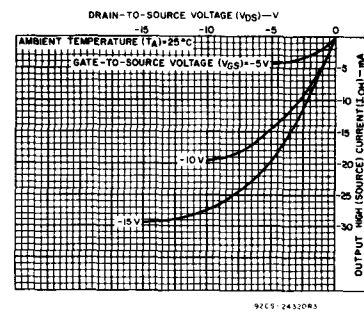

Fig.4 - Typical output high (source) current characteristics.

# CD4502B Types

## RECOMMENDED OPERATING CONDITIONS

For maximum reliability, nominal operating conditions should be selected so that operation is always within the following ranges:

CHARACTERISTIC	LIMITS		UNITS
	Min.	Max.	
Supply-Voltage Range (For $T_A$ = Full Package-Temperature Range)	3	18	V

## STATIC ELECTRICAL CHARACTERISTICS

CHARACTERISTIC	CONDITIONS			LIMITS AT INDICATED TEMPERATURES (°C)							UNITS
	$V_O$ (V)	$V_{IN}$ (V)	$V_{DD}$ (V)	Values at -55, +25, +125 Apply to D, F, K, H Packages			Values at -40, +25, +85 Apply to E Package				
				-55	-40	+85	+125	Min.	Typ.	Max.	
Quiescent Device Current, $I_{DD}$ Max.	-	0.5	5	1	1	30	30	-	0.02	1	$\mu A$
	-	0.10	10	2	2	60	60	-	0.02	2	
	-	0.15	15	4	4	120	120	-	0.02	4	
	-	0.20	20	20	20	600	600	-	0.04	20	
Output Low (Sink) Current $I_{OL}$ Min.	0.4	0.5	5	3.84	3.66	2.52	2.16	3.06	6	-	$mA$
	0.5	0.10	10	9.6	9	6.6	5.4	7.8	15.6	-	
	1.5	0.15	15	25.2	24	16.8	14.4	20.4	40.8	-	
Output High (Source) Current, $I_{OH}$ Min.	4.6	0.5	5	-0.64	-0.61	-0.42	-0.36	-0.51	-1	-	$mA$
	2.5	0.5	5	-2	-1.8	-1.3	-1.15	-1.6	-3.2	-	
	9.5	0.10	10	-1.6	-1.5	-1.1	-0.9	-1.3	-2.6	-	
	13.5	0.15	15	-4.2	-4	-2.8	-2.4	-3.4	-6.8	-	
Output Voltage: Low-Level, $V_{OL}$ Max.	-	0.5	5	0.05			-	0	0.05	-	V
	-	0.10	10	0.05			-	0	0.05	-	
	-	0.15	15	0.05			-	0	0.05	-	
Output Voltage: High-Level, $V_{OH}$ Min.	-	0.5	5	4.95			-	4.95	5	-	V
	-	0.10	10	9.95			-	9.95	10	-	
	-	0.15	15	14.95			-	14.95	15	-	
Input Low Voltage, $V_{IL}$ Max.	0.5, 4.5	-	5	1.5			-	-	1.5	-	V
	1.9	-	10	3			-	-	3	-	
	15, 13.5	-	15	4			-	-	4	-	
Input High Voltage, $V_{IH}$ Min.	4.5	-	5	3.5			-	3.5	-	-	V
	9	-	10	7			-	7	-	-	
	13.5	-	15	11			-	11	-	-	
Input Current $I_{IN}$ Max.		0.18	18	$\pm 0.1$	$\pm 0.1$	$\pm 1$	$\pm 1$	-	$\pm 10^{-5}$	$\pm 0.1$	$\mu A$
3-State Output Leakage Current $I_{OUT}$ Max.	0.18	0.18	18	$\pm 0.4$	$\pm 0.4$	$\pm 12$	$\pm 12$	-	$\pm 10^{-4}$	$\pm 0.4$	$\mu A$

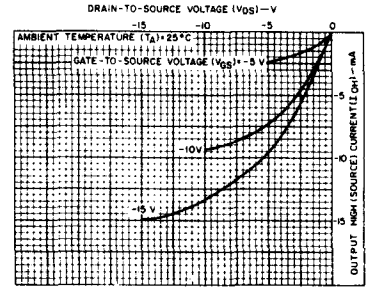

Fig. 5 - Minimum output high (source) current characteristics.

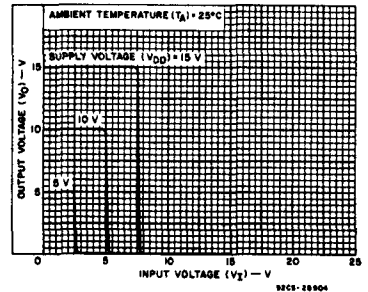

Fig. 6 - Typical voltage transfer characteristics.

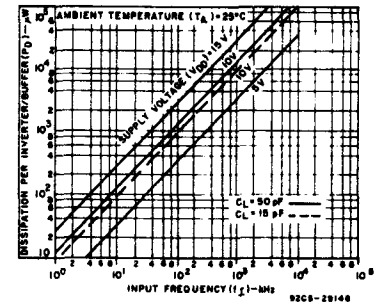

Fig. 7 - Typical power dissipation as a function of input frequency.

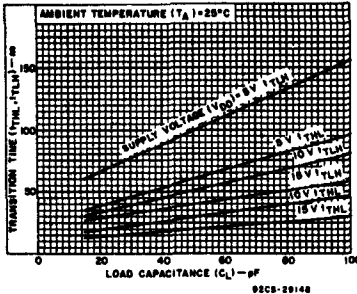

Fig. 8 - Typical transition time as a function of load capacitance.

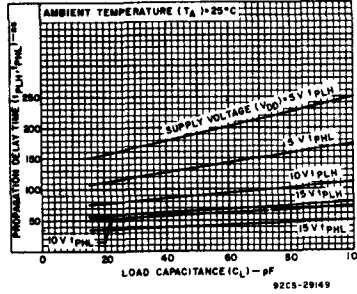

Fig. 9 - Typical propagation delay time as a function of load capacitance.

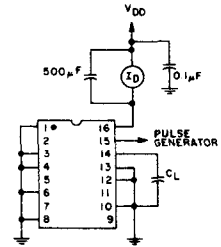

Fig. 10 - Power-dissipation test circuit.

# CD4502B Types

DYNAMIC ELECTRICAL CHARACTERISTICS at  $T_A = 25^\circ\text{C}$ ; Input  $t_r, t_f = 20 \text{ ns}$ ,  $C_L = 50 \text{ pF}$ ,  $R_L = 200 \text{ K}\Omega$  Unless otherwise specified.

CHARACTERISTIC	TEST CONDITIONS	LIMITS		UNITS	
		VDD (V)	TYP		MAX
Data or Inhibit Delay Times: High to Low, $t_{PHL}$		5	135	270	ns
		10	60	120	
		15	40	80	
Low to High, $t_{PLH}$		5	190	380	ns
		10	90	180	
		15	65	130	
Disable Delay Times: $R_L = 1 \text{ K}\Omega$ Output High to High Impedance, $t_{PHZ}$		5	60	120	ns
		10	40	80	
		15	30	60	
High-Impedance to Output High, $t_{PZH}$	See Fig. 14	5	110	220	ns
		10	50	100	
		15	40	80	
Output Low to High Impedance, $t_{PLZ}$		5	125	250	ns
		10	65	130	
		15	55	110	
High Impedance to Output Low, $t_{PZL}$		5	125	250	ns
		10	55	110	
		15	40	80	
Transition Times: Low to High, $t_{TLH}$		5	100	200	ns
		10	50	100	
		15	40	80	
High to Low, $t_{THL}$		5	60	120	ns
		10	30	60	
		15	20	40	
Input Capacitance, $C_{IN}$	Any Input	5	7.5	pF	

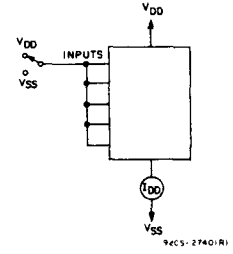

Fig. 11 - Quiescent device current test circuit.

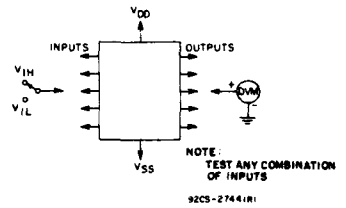

Fig. 12 - Input voltage test circuit.

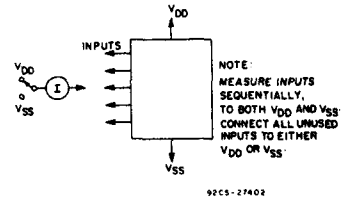

Fig. 13 - Input leakage current test circuit.

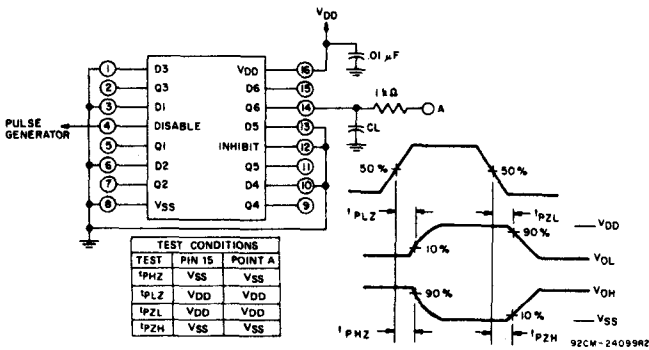
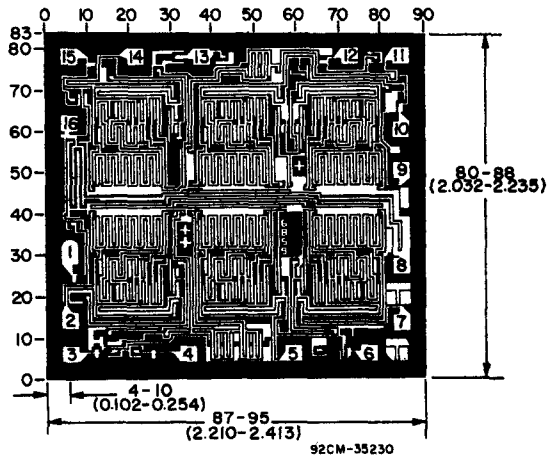

Fig. 14 - Disable delay times test circuit and waveforms.

Dimensions in parentheses are in millimeters and are derived from the basic inch dimensions as indicated. Grid graduations are in mils ( $10^{-3}$  inch.)

The photographs and dimensions of each CMOS chip represent a chip when it is part of the wafer. When the wafer is separated into individual chips, the angle of cleavage may vary with respect to the chip face for different chips. The actual dimensions of the isolated chip, therefore, may differ slightly from the nominal dimensions shown. The user should consider a tolerance of  $-3$  mils to  $+18$  mils applicable to the nominal dimensions shown.



Dimensions and Pad Layout for CD4502B

# CD4503B Types

## CMOS Hex Buffer

High-Voltage Types (20-Volt Rating)

3-State Non-Inverting Type

The RCA-CD4503B is a hex noninverting buffer with 3-state outputs having high sink- and source-current capability. Two disable controls are provided, one of which controls four buffers and the other controls the remaining two buffers. The CD4503B types are supplied in 16-lead hermetic dual-in-line ceramic packages (D and F suffixes), 16-lead dual-in-line plastic packages (E suffix), 16-lead ceramic flat packages (K suffix), and in chip form (H suffix).

### Features:

- 1 TTL-load output drive capability
- 2 output-disable controls
- 3-state outputs
- Pin compatible with industry types MM80C97, MC14503, and 340097
- 5-V, 10-V, and 15-V parametric ratings
- Maximum input current of  $1\ \mu\text{A}$  at 18 V over full package-temperature range; 100 nA at 18 V and  $25^\circ\text{C}$
- Meets all requirements of JEDEC Tentative Standard No. 13A, "Standard Specifications for Description of 'B' Series CMOS Devices"

### Applications:

- 3-state hex buffer for interfacing IC's with data buses
- CMOS to TTL hex buffer

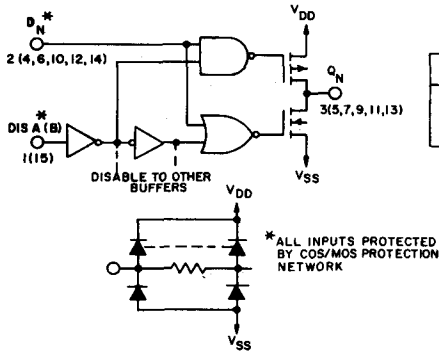
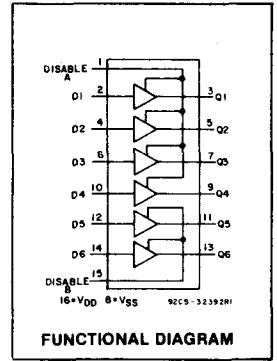

Fig. 1—Logic diagram of 1 to 6 identical buffers.

TRUTH TABLE		
DN	DIS A(B)	QN
0	0	0
1	0	1
X	1	HIGH Z

X = DON'T CARE

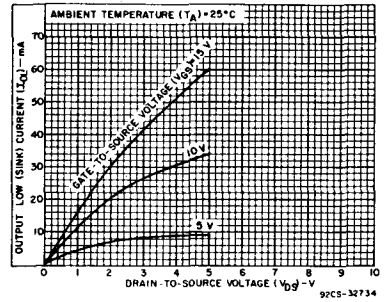

Fig. 2—Typical n-channel output low (sink) current characteristics.

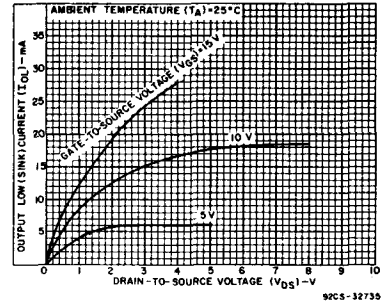
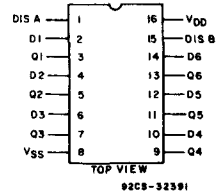

Fig. 3—Minimum n-channel output low (sink) current characteristics.

### MAXIMUM RATINGS, Absolute-Maximum Values:

- DC SUPPLY-VOLTAGE RANGE, ( $V_{DD}$ )  
(Voltages referenced to  $V_{SS}$  Terminal) .....  $-0.5$  to  $+20\ \text{V}$
- INPUT VOLTAGE RANGE, ALL INPUTS .....  $-0.5$  to  $V_{DD} + 0.5\ \text{V}$
- DC INPUT CURRENT, ANY ONE INPUT .....  $\pm 10\ \text{mA}$
- POWER DISSIPATION PER PACKAGE ( $P_D$ ):
- For  $T_A = -40$  to  $+60^\circ\text{C}$  (PACKAGE TYPE E) .....  $500\ \text{mW}$
  - For  $T_A = +60$  to  $+85^\circ\text{C}$  (PACKAGE TYPE E) ..... Derate Linearly at  $12\ \text{mW}/^\circ\text{C}$  to  $200\ \text{mW}$
  - For  $T_A = -55$  to  $+100^\circ\text{C}$  (PACKAGE TYPES D, F, K) .....  $500\ \text{mW}$
  - For  $T_A = +100$  to  $+125^\circ\text{C}$  (PACKAGE TYPES D, F, K) ..... Derate Linearly at  $12\ \text{mW}/^\circ\text{C}$  to  $200\ \text{mW}$
- DEVICE DISSIPATION PER OUTPUT TRANSISTOR
- For  $T_A = \text{FULL PACKAGE-TEMPERATURE RANGE (All Package Types)}$  .....  $100\ \text{mW}$
- OPERATING-TEMPERATURE RANGE ( $T_A$ ):
- PACKAGE TYPES D, F, K, H .....  $-55$  to  $+125^\circ\text{C}$
  - PACKAGE TYPE E .....  $-40$  to  $+85^\circ\text{C}$
- STORAGE TEMPERATURE RANGE ( $T_{stg}$ ) .....  $-65$  to  $+150^\circ\text{C}$
- LEAD TEMPERATURE (DURING SOLDERING):
- At distance  $1/16 \pm 1/32$  inch ( $1.59 \pm 0.79\ \text{mm}$ ) from case for 10 s max. ....  $+265^\circ\text{C}$



### TERMINAL ASSIGNMENT

# CD4503B Types

## STATIC ELECTRICAL CHARACTERISTICS

CHARACTERISTIC	CONDITIONS			LIMITS AT INDICATED TEMPERATURES (°C)							UNITS
				Values at -55, +25, +125 Apply to D, F, K, H Packages Values at -40, +25, +85 Apply to E Package							
	V <sub>O</sub> (V)	V <sub>IN</sub> (V)	V <sub>DD</sub> (V)	-55	-40	+85	+125	+25			
								Min.	Typ.	Max.	
Quiescent Device	—	0,5	5	1	1	30	30	—	0.02	1	μA
Current, I <sub>DD</sub> Max.	—	0,10	10	2	2	60	60	—	0.02	2	
Output Low (Sink) Current I <sub>OL</sub> Min.	—	0,15	15	4	4	120	120	—	0.02	4	
Output High (Source) Current I <sub>OH</sub> Min.	—	0,20	20	20	20	600	600	—	0.04	20	
Output Low (Sink) Current I <sub>OL</sub> Min.	0.4	0	5	2.6	2.5	1.4	1.3	2.1	2.3	—	mA
Output High (Source) Current I <sub>OH</sub> Min.	0.5	0	10	6.5	6.4	3.9	3.8	5.5	6.2	—	
Output Low (Sink) Current I <sub>OL</sub> Min.	1.5	0	15	19.2	18.9	11.4	11.2	16.1	23	—	
Output High (Source) Current I <sub>OH</sub> Min.	4.6	5	5	-1.2	-1.16	-0.7	-0.7	-1.02	-1.9	—	mA
Output High (Source) Current I <sub>OH</sub> Min.	2.5	5	5	-5.8	-5.7	-3.4	-3	-4.8	-6.1	—	
Output High (Source) Current I <sub>OH</sub> Min.	9.5	10	10	-3.1	-3	-1.9	-1.8	-2.6	-3.7	—	
Output High (Source) Current I <sub>OH</sub> Min.	13.5	15	15	-8.2	-8	-4.9	-4.8	-6.8	-14.1	—	
Output Voltage: Low-Level, V <sub>OL</sub> Max.	—	0,5	5	0.05				—	0	0.05	V
Output Voltage: Low-Level, V <sub>OL</sub> Max.	—	0,10	10	0.05				—	0	0.05	
Output Voltage: Low-Level, V <sub>OL</sub> Max.	—	0,15	15	0.05				—	0	0.05	
Output Voltage: High-Level, V <sub>OH</sub> Min.	—	0,5	5	4.95				4.95	5	—	V
Output Voltage: High-Level, V <sub>OH</sub> Min.	—	0,10	10	9.95				9.95	10	—	
Output Voltage: High-Level, V <sub>OH</sub> Min.	—	0,15	15	14.95				14.95	15	—	
Input Low Voltage, V <sub>IL</sub> Max.	0.5, 4.5	—	5	1.5				—	—	1.5	V
Input Low Voltage, V <sub>IL</sub> Max.	1.9	—	10	3				—	—	3	
Input Low Voltage, V <sub>IL</sub> Max.	1.5, 13.5	—	15	4				—	—	4	
Input High Voltage, V <sub>IH</sub> Min.	0.5, 4.5	—	5	3.5				3.5	—	—	V
Input High Voltage, V <sub>IH</sub> Min.	1.9	—	10	7				7	—	—	
Input High Voltage, V <sub>IH</sub> Min.	1.5, 13.5	—	15	11				11	—	—	
Input Current I <sub>IN</sub> Max.	—	0,18	18	±0.1	±0.1	±1	±1	—	±10 <sup>-5</sup>	±0.1	μA
3-State Output Leakage Current, I <sub>OUT</sub> Max.	0,18	0,18	18	±0.4	±0.4	±12	±12	—	±10 <sup>-4</sup>	±0.4	
3-State Output Leakage Current, I <sub>OUT</sub> Max.	0,18	0,18	18	±0.4	±0.4	±12	±12	—	±10 <sup>-4</sup>	±0.4	

## RECOMMENDED OPERATING CONDITIONS

For maximum reliability, nominal operating conditions should be selected so that operation is always within the following ranges:

CHARACTERISTIC	LIMITS		UNITS
	Min.	Max.	
Supply-Voltage Range (For T <sub>A</sub> = Full Package-Temperature Range)	3	18	V

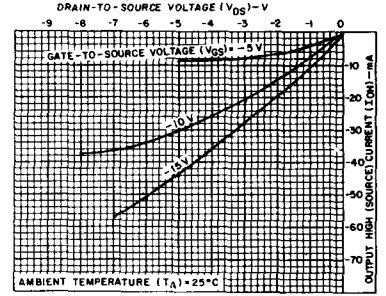

Fig. 4—Typical p-channel output high (source) current characteristics.

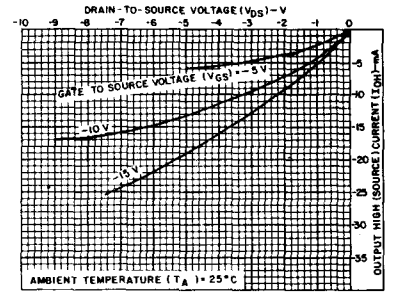

Fig. 5—Minimum p-channel output high (source) current characteristics.

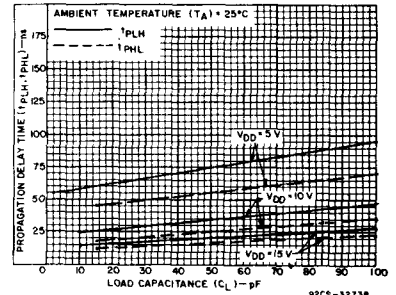

Fig. 6—Typical propagation delay time as a function of load capacitance.

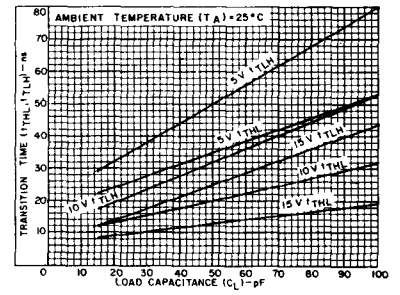

Fig. 7—Typical transition time as a function of load capacitance.

# CD4503B Types

**DYNAMIC ELECTRICAL CHARACTERISTICS at  $T_A = 25^\circ\text{C}$ ; Input  $t_r, t_f = 20\text{ ns}$ ,  $C_L = 50\text{ pF}$ ,  $R_L = 200\text{ k}\Omega$  unless otherwise specified.**

CHARACTERISTIC	$V_{DD}$ (V)	LIMITS		UNITS
		Typ.	Max.	
Propagation Delay Time: Low-to-High, $t_{PLH}$	5	75	150	ns
	10	35	70	
	15	25	50	
High-to-Low, $t_{PHL}$	5	55	110	ns
	10	25	50	
	15	17	35	
Transition Time: Low-to-High, $t_{TLH}$	5	50	90	ns
	10	30	45	
	15	25	35	
High-to-Low, $t_{THL}$	5	35	70	ns
	10	20	40	
	15	13	25	
3-State Propagation Delay Time: $R_L = 1\text{ k}\Omega$ $t_{PHZ}, t_{PZH}$	5	70	140	ns
	10	30	60	
	15	25	50	
$t_{PZL}, t_{PLZ}$	5	90	180	ns
	10	40	80	
	15	35	70	

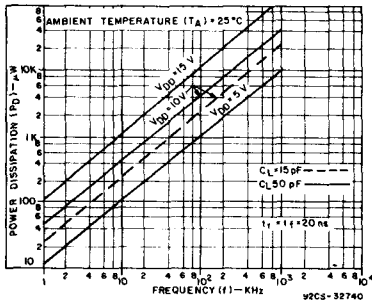

Fig. 8—Typical power dissipation as a function of frequency.

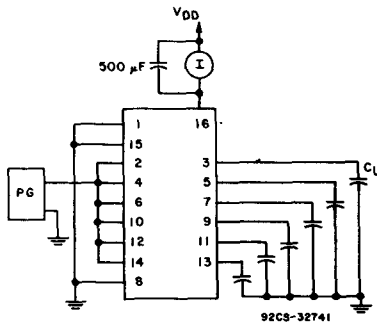

Fig. 9—Dynamic power dissipation test circuit.

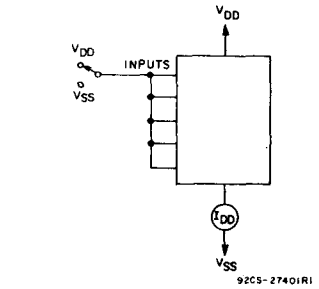

Fig. 10—Quiescent device current test circuit.

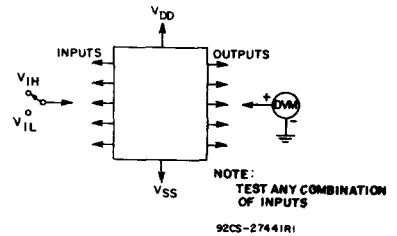

Fig. 11—Input voltage test circuit.

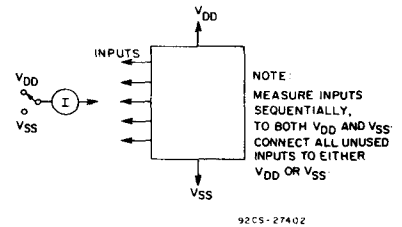
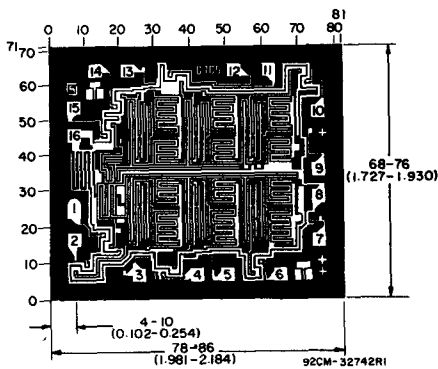

Fig. 12—Input current test circuit.



### Dimensions and pad layout for CD4503BH

Dimensions in parentheses are in millimeters and are derived from the basic inch dimensions as indicated. Grid graduations are in mils ( $10^{-3}$  inch).

The photographs and dimensions of each CMOS chip represent a chip when it is part of the wafer. When the wafer is separated into individual chips, the angle of cleavage may vary with respect to the chip face for different chips. The actual dimensions of the isolated chip, therefore, may differ slightly from the nominal dimensions shown. The user should consider a tolerance of  $-3$  mils to  $+16$  mils applicable to the nominal dimensions shown.

# CMOS Dual 4-Bit Latch

High-Voltage Types (20-Volt Rating)

The RCA-CD4508B dual 4-bit latch contains two identical 4-bit latches with separate STROBE, RESET, and OUTPUT DISABLE controls. With the STROBE line in the high state, the data on the "D" inputs appear at the corresponding "Q" outputs provided the DISABLE line is in the low state. Changing the STROBE line to the low state locks the data into the latch. A high on the reset line forces the outputs to a low level regardless of the state of the STROBE input. The outputs are forced to the high-impedance state for bus line applications by a high level on the DISABLE input.

The CD4508B types are supplied in the 24-lead dual-in-line ceramic packages (D and F suffixes), 24-lead dual-in-line plastic packages (E suffix), 24-lead ceramic flat packages (K suffix), and in chip form (H suffix).

The CD4508B is similar to industry type MC14508.

**Features:**

- Two independent 4-bit latches
- Individual master reset for each 4-bit latch
- 3-state outputs with high-impedance state for bus line applications
- Medium-speed operation:  $t_{PHL} = t_{PLH} = 70$  ns (typ.) at  $V_{DD} = 10$  V and  $C_L = 50$  pF
- 100% tested for quiescent current at 20 V
- 5-V, 10-V, and 15-V parametric ratings
- Standardized, symmetrical output characteristics
- Maximum input current of 1  $\mu$ A at 18 V over full package-temperature range; 100 nA at 18 V and 25°C
- Noise margin (full package-temperature range) =
  - 1 V at  $V_{DD} = 5$  V
  - 2 V at  $V_{DD} = 10$  V
  - 2.5 V at  $V_{DD} = 15$  V
- Meets all requirements of JEDEC Tentative Standard No. 13A, "Standard Specifications for Description of 'B' Series CMOS Devices"

**Applications:**

- Buffer storage
- Holding registers
- Data storage and multiplexing

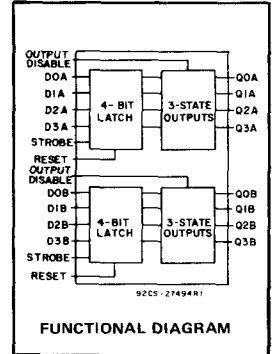

**MAXIMUM RATINGS, Absolute-Maximum Values:**

DC SUPPLY-VOLTAGE RANGE, ( $V_{DD}$ ) (Voltages referenced to $V_{SS}$ Terminal)	-0.5 to +20 V
INPUT VOLTAGE RANGE, ALL INPUTS	-0.5 to $V_{DD} + 0.5$ V
DC INPUT CURRENT, ANY ONE INPUT	$\pm 10$ mA
POWER DISSIPATION PER PACKAGE ( $P_D$ ):	
For $T_A = -40$ to $+60^\circ\text{C}$ (PACKAGE TYPE E)	500 mW
For $T_A = +60$ to $+85^\circ\text{C}$ (PACKAGE TYPE E)	Derate Linearly at 12 mW/ $^\circ\text{C}$ to 200 mW
For $T_A = -55$ to $+100^\circ\text{C}$ (PACKAGE TYPES D, F, K)	500 mW
For $T_A = +100$ to $+125^\circ\text{C}$ (PACKAGE TYPES D, F, K)	Derate Linearly at 12 mW/ $^\circ\text{C}$ to 200 mW
DEVICE DISSIPATION PER OUTPUT TRANSISTOR FOR $T_A =$ FULL PACKAGE-TEMPERATURE RANGE (All Package Types)	100 mW
OPERATING-TEMPERATURE RANGE ( $T_A$ ):	
PACKAGE TYPES D, F, K, H	-55 to $+125^\circ\text{C}$
PACKAGE TYPE E	-40 to $+85^\circ\text{C}$
STORAGE TEMPERATURE RANGE ( $T_{stg}$ )	-65 to $+150^\circ\text{C}$
LEAD TEMPERATURE (DURING SOLDERING):	
At distance 1/16 $\pm$ 1/32 inch (1.59 $\pm$ 0.79 mm) from case for 10 s max.	$+265^\circ\text{C}$

**RECOMMENDED OPERATING CONDITIONS at  $T_A = 25^\circ\text{C}$ , Except as Noted. For maximum reliability, nominal operating conditions should be selected so that operation is always within the following ranges:**

CHARACTERISTIC	$V_{DD}$ (V)	LIMITS		UNITS
		Min.	Max.	
Supply-Voltage Range (For $T_A =$ Full Package-Temperature Range)		3	18	V
Reset Pulse Width, $t_W(R)$	5	200	—	ns
	10	140	—	
	15	100	—	
Strobe Pulse Width, $t_W(st)$	5	140	—	ns
	10	80	—	
	15	70	—	
Setup Time, $t_{SU}$	5	50	—	ns
	10	30	—	
	15	20	—	
Hold Time, $t_H$	5	0	—	ns
	10	0	—	
	15	0	—	

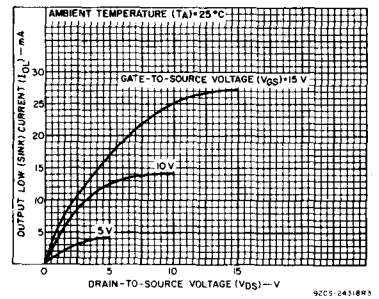

Fig. 2 - Typical output low (sink) current characteristics.

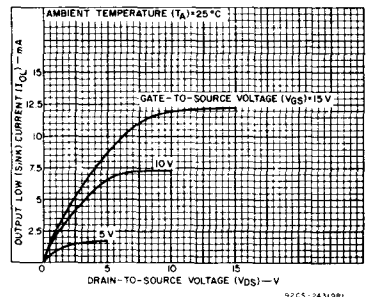

Fig. 3 - Minimum output low (sink) current characteristics.

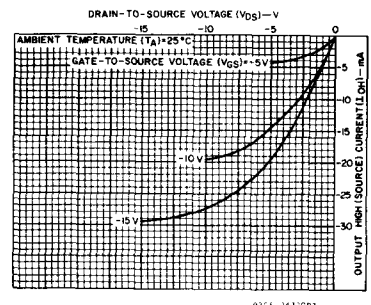
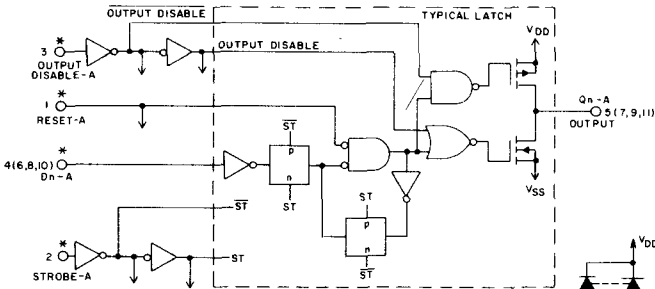

Fig. 4 - Typical output high (source) current characteristics.

# CD4508B Types

## STATIC ELECTRICAL CHARACTERISTICS

CHARACTERISTIC	CONDITIONS			LIMITS AT INDICATED TEMPERATURES (°C)							UNITS
	V <sub>O</sub> (V)	V <sub>IN</sub> (V)	V <sub>DD</sub> (V)	Values at -55, +25, +125 Apply to D, F, K, H Packages Values at -40, +25, +85 Apply to E Package							
				-55	-40	+85	+125	Min.	Typ.	Max.	
Quiescent Device Current, I <sub>DD</sub> Max.	-	0,5	5	5	5	150	150	-	0.04	5	μA
	-	0,10	10	10	10	300	300	-	0.04	10	
	-	0,15	15	20	20	600	600	-	0.04	20	
Output Low (Sink) Current I <sub>OL</sub> Min.	0.4	0,5	5	0.64	0.61	0.42	0.36	0.51	1	-	mA
	0.5	0,10	10	1.6	1.5	1.1	0.9	1.3	2.6	-	
	1.5	0,15	15	4.2	4	2.8	2.4	3.4	6.8	-	
Output High (Source) Current, I <sub>OH</sub> Min.	4.6	0,5	5	-0.64	-0.61	-0.42	-0.36	-0.51	-1	-	mA
	2.5	0,5	5	-2	-1.8	-1.3	-1.15	-1.6	-3.2	-	
	9.5	0,10	10	-1.6	-1.5	-1.1	-0.9	-1.3	-2.6	-	
Output Voltage: Low-Level, V <sub>OL</sub> Max.	-	0,5	5				0.05	-	0	0.05	V
	-	0,10	10				0.05	-	0	0.05	
	-	0,15	15				0.05	-	0	0.05	
Output Voltage: High-Level, V <sub>OH</sub> Min.	-	0,5	5				4.95	4.95	5	-	V
	-	0,10	10				9.95	9.95	10	-	
	-	0,15	15				14.95	14.95	15	-	
Input Low Voltage, V <sub>IL</sub> Max.	0.5, 4.5	-	5				1.5	-	-	1.5	V
	1, 9	-	10				3	-	-	3	
	1.5, 13.5	-	15				4	-	-	4	
Input High Voltage, V <sub>IH</sub> Min.	0.5, 4.5	-	5				3.5	3.5	-	-	V
	1, 9	-	10				7	7	-	-	
	1.5, 13.5	-	15				11	11	-	-	
Input Current I <sub>IN</sub> Max.	-	0,18	18	±0.1	±0.1	±1	±1	-	±10 <sup>-5</sup>	±0.1	μA
3-State Output Leakage Current I <sub>OUT</sub> Max.	0,18	0,18	18	±0.4	±0.4	±12	±12	-	±10 <sup>-4</sup>	±0.4	μA



RESET	DISABLE	STROBE	D INPUT	Q OUTPUT
0	0	1	1	1
0	0	1	0	0
0	0	0	X	LATCHED
1	0	X	X	0
X	1	X	X	Z

1 = HIGH LEVEL      X = DON'T CARE  
0 = LOW LEVEL      Z = HIGH IMPEDANCE

Fig. 7 - Logic diagram (A-Section), 1 of 4 identical latches with common output disable, reset, and strobe.

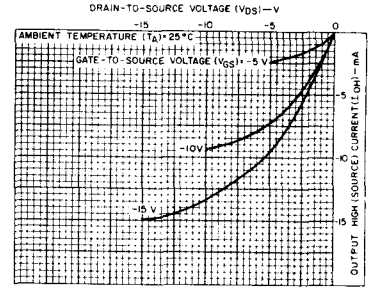

Fig. 4 - Minimum output high (source) current characteristics.

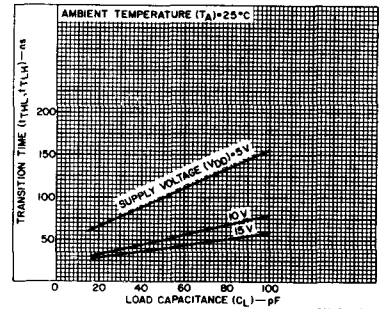

Fig. 5 - Typical transition time as a function of load capacitance.

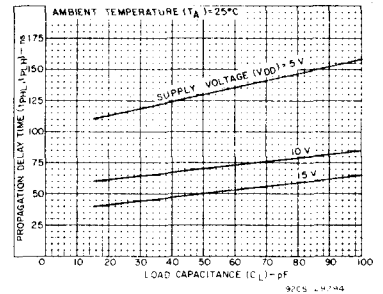

Fig. 6 - Typical propagation delay time as a function of load capacitance (strobe to data out).

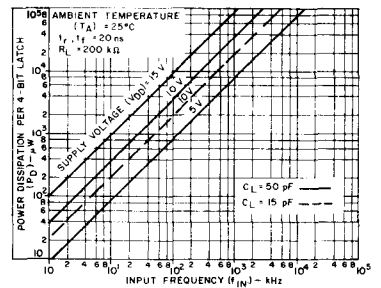

Fig. 8 - Typical power dissipation as a function of frequency.



# CD4508B Types

DYNAMIC ELECTRICAL CHARACTERISTICS at  $T_A = 25^\circ\text{C}$ ; Input  $t_r, t_f = 20 \text{ ns}$ ,  $C_L = 50 \text{ pF}$ ,  $R_L = 200 \text{ k}\Omega$ , unless otherwise specified.

CHARACTERISTIC	TEST CONDITIONS	LIMITS			UNITS
		VDD	Typ.	Max.	
Transition Time, $t_{THL}, t_{TLH}$		5	100	200	
		10	50	100	
		15	40	80	
Minimum Reset Pulse Width, $t_{W(R)}$		5	100	200	
		10	70	140	
		15	50	100	
Minimum Strobe Pulse Width, $t_{W(st)}$		5	70	140	
		10	40	80	
		15	35	70	
Minimum Setup Time, $t_{SU}$		5	25	50	
		10	15	30	
		15	10	20	
Minimum Hold Time, $t_H$		5	0	0	
		10	0	0	
		15	0	0	
Propagation Delay Times: $t_{PHL}, t_{PLH}$ Strobe to Data Out		5	130	260	ns
		10	70	140	
		15	50	100	
Data In to Data Out		5	105	210	
		10	60	120	
		15	45	90	
Reset to Data Out		5	90	180	
		10	50	100	
		15	40	80	
3-State Propagation Delay Times: Output High to High Impedance, $t_{PHZ}$		5	90	180	
		10	50	100	
		15	35	70	
High Impedance to Output High, $t_{pZH}$		5	90	180	
		10	50	100	
		15	35	70	
Output Low to High Impedance, $t_{pLZ}$		5	90	180	
		10	50	100	
		15	35	70	
High Impedance to Output Low, $t_{pZL}$		5	90	180	
		10	50	100	
		15	35	70	
Input Capacitance, $C_{iN}$	Any Input	—	5	7.5	pF

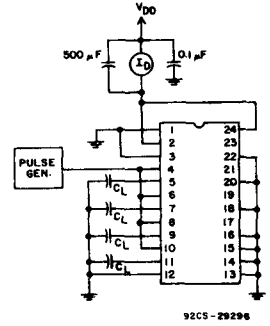

Fig. 9 — Power dissipation test circuit.

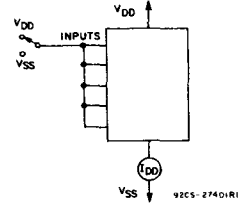

Fig. 10 — Quiescent device current test circuit.

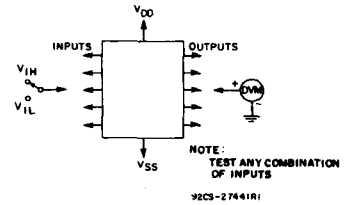

Fig. 11 — Input voltage test circuit.

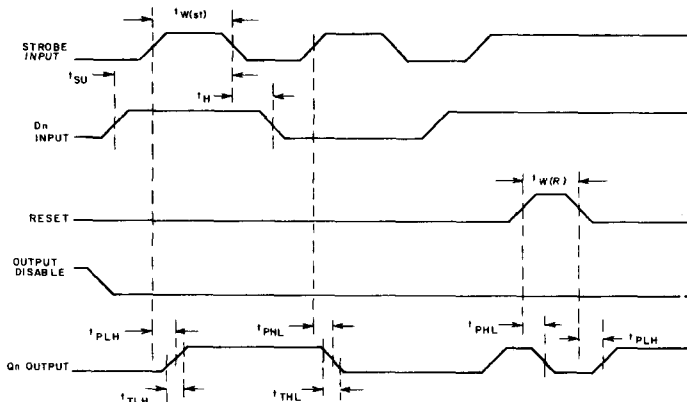

Fig. 12 — Test waveforms.

92CM-29297

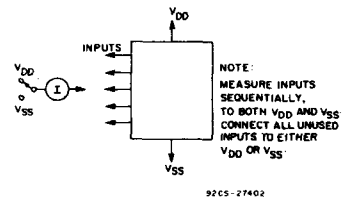

Fig. 13 — Input current test circuit.

# CD4508B Types

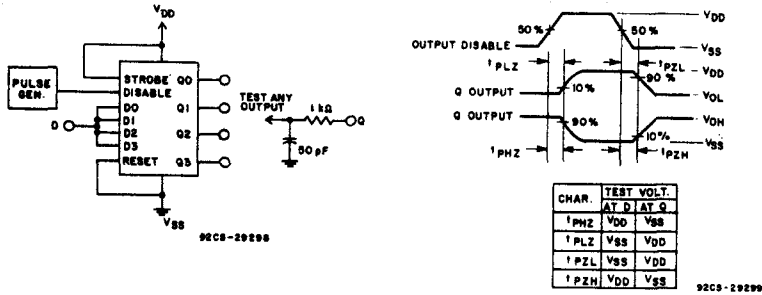

Fig. 14 - Output disable test circuit and waveforms.

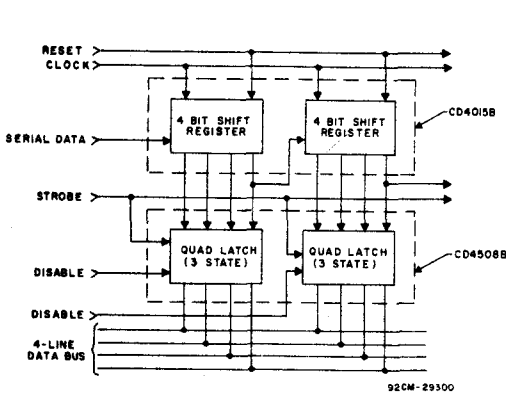

Fig. 15 - Bus register.

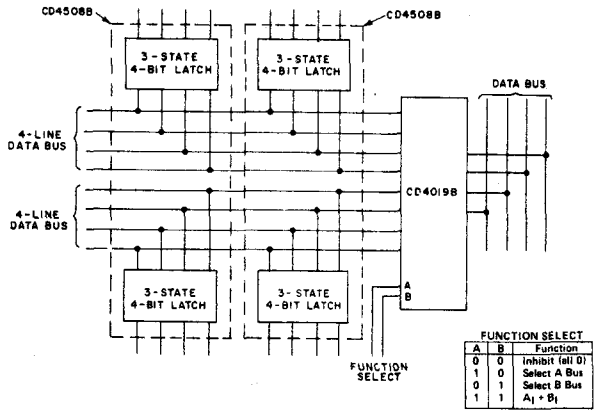
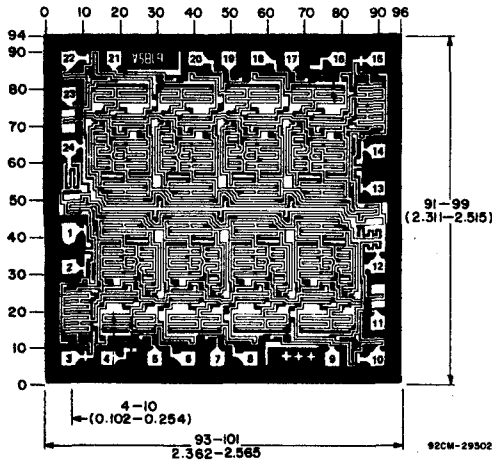
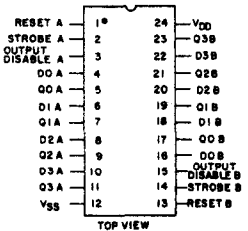

Fig. 16 - Dual multiplexed bus register with function select.



The photographs and dimensions of each CMOS chip represent a chip when it is part of the wafer. When the wafer is separated into individual chips, the angle of cleavage may vary with respect to the chip face for different chips. The actual dimensions of the isolated chip, therefore, may differ slightly from the nominal dimensions shown. The user should consider a tolerance of  $\pm 3$  mils to  $\pm 16$  mils applicable to the nominal dimensions shown.

Dimensions and pad layout for CD4508B.



TERMINAL ASSIGNMENT

Dimensions in parentheses are in millimeters and are derived from the basic inch dimensions as indicated. Grid graduations are in mils ( $10^{-3}$  inch).

# CMOS Presettable Up/Down Counters

High-Voltage Types (20-Volt Rating)

CD4510B --- BCD Type

CD4516B --- Binary Type

The RCA-CD4510B Presettable BCD Up/Down Counter and the CD4516 Presettable Binary Up/Down Counter consist of four synchronously clocked D-type flip-flops (with a gating structure to provide T-type flip-flop capability) connected as counters. These counters can be cleared by a high level on the RESET line, and can be preset to any binary number present on the jam inputs by a high level on the PRESET ENABLE line. The CD4510B will count out of non-BCD counter states in a maximum of two clock pulses in the up mode, and a maximum of four clock pulses in the down mode.

If the CARRY-IN input is held low, the counter advances up or down on each positive-going clock transition. Synchronous cascading is accomplished by connecting all clock inputs in parallel and connecting the CARRY-OUT of a less significant stage to the CARRY-IN of a more significant stage.

The CD4510B and CD4516B can be cascaded in the ripple mode by connecting the CARRY-OUT to the clock of the next stage. If the UP/DOWN input changes during a terminal count, the CARRY-OUT must be gated with the clock, and the UP/DOWN input must change while the clock is high. This method provides a clean clock signal to the subsequent counting stage. (See Fig. 15).

These devices are similar to types MC14510 and MC14516.

The CD4510B and CD4516B Series types are supplied in 16-lead hermetic dual-in-line ceramic packages (D and F suffixes), 16-lead dual-in-line plastic packages (E suffix), 16-lead ceramic flat packages (K suffix), and in chip form (H suffix).

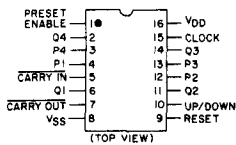

CD4510B, CD4516B  
TERMINAL ASSIGNMENT

**Features:**

- Medium-speed operation --  $f_{CL} = 8 \text{ MHz typ. at } 10 \text{ V}$
- Synchronous internal carry propagation
- Reset and Preset capability
- 100% tested for quiescent current at 20 V
- 5-V, 10-V, and 15-V parametric ratings
- Standardized symmetrical output characteristics
- Maximum input current of  $1 \mu\text{A}$  at 18 V over full package temperature range; 100 nA at 18 V and 25°C
- Noise margin (full package-temperature range):
  - 1 V at  $V_{DD} = 5 \text{ V}$
  - 2 V at  $V_{DD} = 10 \text{ V}$
  - 2.5 V at  $V_{DD} = 15 \text{ V}$
- Meets all requirements of JEDEC Tentative Standard No. 13A, "Standard Specifications for Description of 'B' Series CMOS Devices"

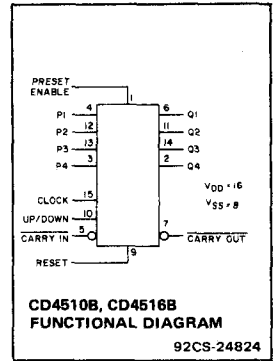

**Applications:**

- Up/Down difference counting
- Multistage synchronous counting
- Multistage ripple counting
- Synchronous frequency dividers

**OPERATING CONDITIONS AT  $T_A = 25^\circ\text{C}$ , Unless Otherwise Specified**

For maximum reliability, nominal operating conditions should be selected so that operation is always within the following ranges.

Characteristic	$V_{DD}$	Min.	Max.	Units
Supply Voltage Range (At $T_A = \text{Full Package-Temperature Range}$ )		3	18	V
Clock Pulse Width, $t_W$	5	150	—	ns
	10	75	—	
	15	60	—	
Clock Input Frequency, $f_{CL}$	5	—	2	MHz
	10	—	4	
	15	—	5.5	
Preset Enable or Reset Removal Time <sup>•</sup>	5	150	—	ns
	10	80	—	
	15	60	—	
Clock Rise and Fall Time, $t_{rCL}$ , $t_{fCL}$ *	5	—	15	$\mu\text{s}$
	10	—	5	
	15	—	5	
Carry-In Setup Time, $t_S$	5	130	—	ns
	10	60	—	
	15	45	—	
Up-Down Setup Time, $t_S$	5	360	—	ns
	10	160	—	
	15	110	—	
Preset Enable or Reset Pulse Width, $t_W$	5	220	—	ns
	10	100	—	
	15	75	—	

<sup>•</sup>Time required after the falling edge of the reset or preset enable inputs before the rising edge of the clock will trigger the counter (similar to setup time).

\*If more than one unit is cascaded in the parallel clocked application,  $t_{rCL}$  should be made less than or equal to the sum of the fixed propagation delay at 15 pF and the transition time of the carry output driving stage for the estimated capacitive load.

# CD4510B, CD4516B Types

## MAXIMUM RATINGS, Absolute-Maximum Values:

DC SUPPLY-VOLTAGE RANGE, ( $V_{DD}$ )	-0.5 to +20 V
(Voltages referenced to $V_{SS}$ Terminal)	
INPUT VOLTAGE RANGE, ALL INPUTS	-0.5 to $V_{DD} + 0.5$ V
DC INPUT CURRENT, ANY ONE INPUT	$\pm 10$ mA
POWER DISSIPATION PER PACKAGE ( $P_D$ ):	
For $T_A = -40$ to $+60^\circ\text{C}$ (PACKAGE TYPE E)	500 mW
For $T_A = +60$ to $+85^\circ\text{C}$ (PACKAGE TYPE E)	Derate Linearly at 12 mW/ $^\circ\text{C}$ to 200 mW
For $T_A = -55$ to $+100^\circ\text{C}$ (PACKAGE TYPES D, F, K)	500 mW
For $T_A = +100$ to $+125^\circ\text{C}$ (PACKAGE TYPES D, F, K)	Derate Linearly at 12 mW/ $^\circ\text{C}$ to 200 mW
DEVICE DISSIPATION PER OUTPUT TRANSISTOR:	
For $T_A = \text{FULL PACKAGE-TEMPERATURE RANGE (All Package Types)}$	100 mW
OPERATING-TEMPERATURE RANGE ( $T_A$ ):	
PACKAGE TYPES D, F, K, H	-55 to $+125^\circ\text{C}$
PACKAGE TYPE E	-40 to $+85^\circ\text{C}$
STORAGE TEMPERATURE RANGE ( $T_{stg}$ )	-65 to $+150^\circ\text{C}$
LEAD TEMPERATURE (DURING SOLDERING):	
At distance $1/16 \pm 1/32$ inch (1.59 $\pm$ 0.79 mm) from case for 10 s max.	$+265^\circ\text{C}$

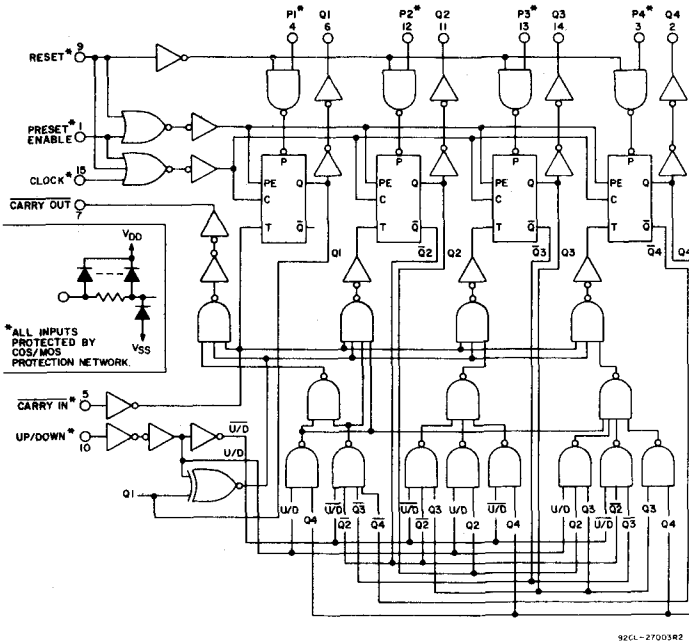

Fig.3 - Logic Diagram for CD4510B.

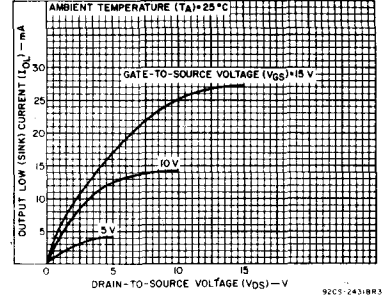

Fig.1 - Typical output low (sink) current characteristics.

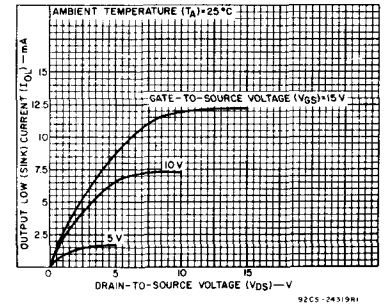

Fig.2 - Minimum output low (sink) current characteristics.

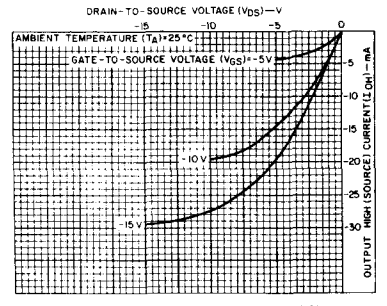

Fig.4 - Typical output high (source) current characteristics.

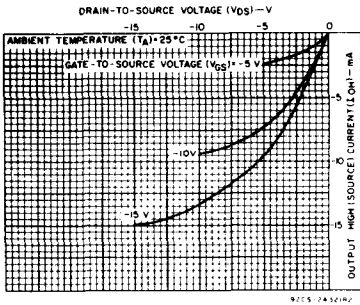

Fig.5 - Minimum output high (source) current characteristics.

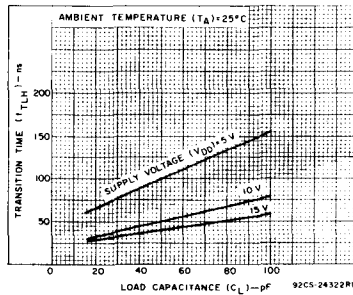

Fig.6 - Typical transition time vs. load capacitance.

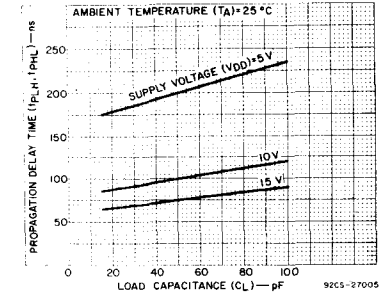

Fig.7 - Typical propagation delay time vs. load capacitance for clock-to-Q outputs.

# CD4510B, CD4516B Types

## STATIC ELECTRICAL CHARACTERISTICS

CHARACTERISTIC	CONDITIONS			LIMITS AT INDICATED TEMPERATURES (°C)							UNITS
	V <sub>O</sub> (V)	V <sub>IN</sub> (V)	V <sub>DD</sub> (V)	Values at -55, +25, +125 Apply to D, F, K, H Packages				Values at -40, +25, +85 Apply to E Package			
				-55	-40	+85	+125	+25			
				Min.	Typ.	Max.					
Quiescent Device Current, I <sub>DD</sub> Max.	-	0.5	5	5	5	150	150	-	0.04	5	μA
	-	0.10	10	10	10	300	300	-	0.04	10	
	-	0.15	15	20	20	600	600	-	0.04	20	
	-	0.20	20	100	100	3000	3000	-	0.08	100	
Output Low (Sink) Current I <sub>OL</sub> Min.	0.4	0.5	5	0.64	0.61	0.42	0.36	0.51	1	-	mA
	0.5	0.10	10	1.6	1.5	1.1	0.9	1.3	2.6	-	
	1.5	0.15	15	4.2	4	2.8	2.4	3.4	6.8	-	
Output High (Source) Current, I <sub>OH</sub> Min.	4.6	0.5	5	-0.64	-0.61	-0.42	-0.36	-0.51	-1	-	mA
	2.5	0.5	5	-2	-1.8	-1.3	-1.15	-1.6	-3.2	-	
	9.5	0.10	10	-1.6	-1.5	-1.1	-0.9	-1.3	-2.6	-	
Output Voltage: Low-Level, V <sub>OL</sub> Max.	-	0.5	5	0.05			0			0.05	V
	-	0.10	10	0.05			-			0.05	
	-	0.15	15	0.05			-			0.05	
Output Voltage: High-Level, V <sub>OH</sub> Min.	-	0.5	5	4.95			4.95			5	V
	-	0.10	10	9.95			9.95			10	
	-	0.15	15	14.95			14.95			15	
Input Low Voltage, V <sub>IL</sub> Max.	0.5, 4.5	-	5	1.5			-			1.5	V
	1.9	-	10	3			-			3	
	1.5, 13.5	-	15	4			-			4	
Input High Voltage, V <sub>IH</sub> Min.	0.5, 4.5	-	5	3.5			3.5			-	V
	1.9	-	10	7			7			-	
	1.5, 13.5	-	15	11			11			-	
Input Current I <sub>IN</sub> Max.	-	0.18	18	±0.1	±0.1	±1	±1	-	±10 <sup>-5</sup>	±0.1	μA

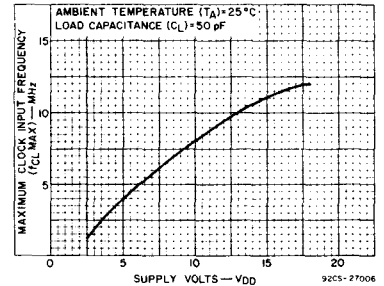

Fig. 8 - Typical maximum clock input frequency vs. supply voltage.

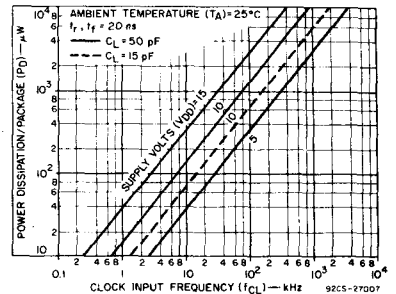

Fig. 9 - Typical dynamic power dissipation vs. frequency.

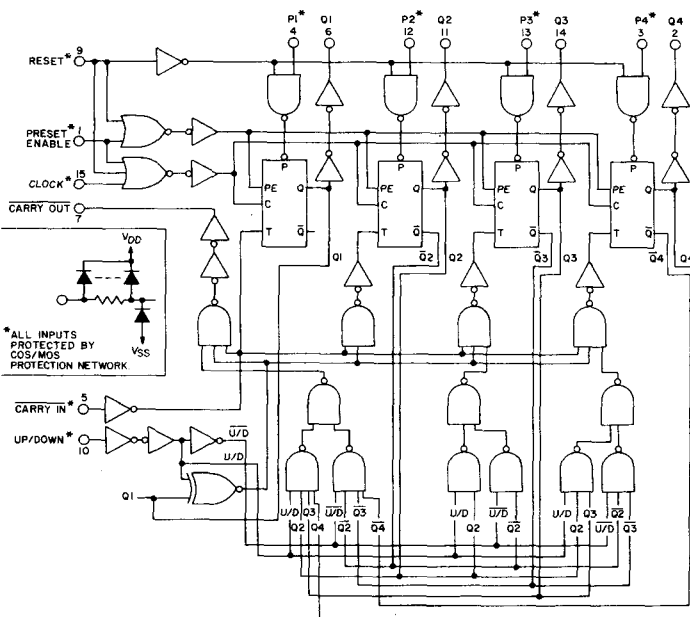

Fig. 10 - Logic Diagram for CD4516B.

92CL-27004R2

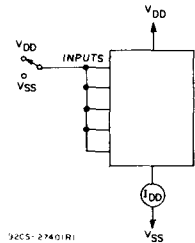
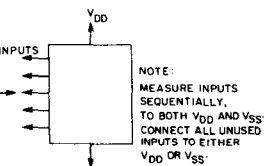

Fig. 11 - Quiescent-device-current test circuit.



92CS-274C2

Fig. 12 - Input-current test circuit.

# CD4510B, CD4516B Types

DYNAMIC ELECTRICAL CHARACTERISTICS at  $T_A = 25^\circ\text{C}$ ,  $C_L = 50\text{ pF}$ ,  
 Input  $t_r, t_f = 20\text{ ns}$ ,  $R_L = 200\text{ k}\Omega$

Characteristic	Conditions $V_{DD}$ (V)	Limits			Units
		All Packages			
		Min.	Typ.	Max.	
Propagation Delay Time ( $t_{PHL}, t_{PLH}$ ): Clock-to-Q Output (See Fig. 10)	5	—	200	400	ns
	10	—	100	200	
	15	—	75	150	
Preset or Reset-to-Q Output	5	—	210	420	ns
	10	—	105	210	
	15	—	80	160	
Clock-to-Carry Out	5	—	240	480	ns
	10	—	120	240	
	15	—	90	180	
Carry-In-to-Carry Out	5	—	125	250	ns
	10	—	60	120	
	15	—	50	100	
Preset or Reset-to-Carry Out	5	—	320	640	ns
	10	—	160	320	
	15	—	125	250	
Transition Time ( $t_{THL}, t_{TLH}$ ) (See Fig. 9)	5	—	100	200	ns
	10	—	50	100	
	15	—	40	80	
Max. Clock Input Frequency ( $f_{CL}$ )	5	2	4	—	MHz
	10	4	8	—	
	15	5.5	11	—	
Input Capacitance ( $C_{IN}$ )		—	5	7.5	pF
Set-up Time, $t_S$ Preset Enable to $J_n$	5	25	12	—	ns
	10	10	6	—	
	15	10	5	—	
Hold times, $t_H$ Clock to Carry-In	5	60	30	—	ns
	10	30	4	—	
	15	30	1	—	
Clock to Up/Down	5	30	10	—	ns
	10	30	4	—	
	15	30	5	—	
Preset Enable to $J_n$	5	70	35	—	ns
	10	40	20	—	
	15	40	20	—	

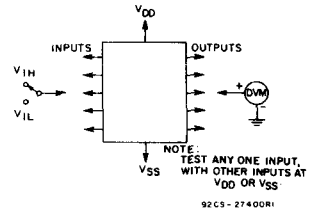

Fig. 13 - Input-voltage test circuit.

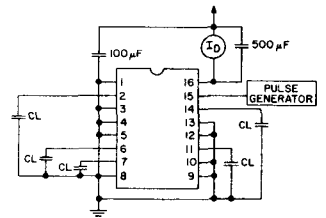

Fig. 14 - Power-dissipation test circuit and input waveform.

# CD4510B, CD4516B Types

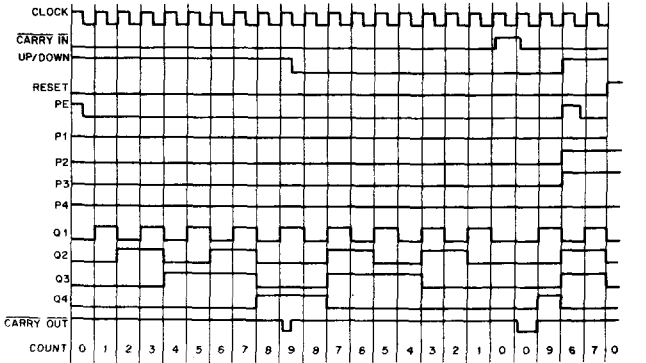

Fig. 15 — Timing Diagram for CD4510B.

92CM-7700B

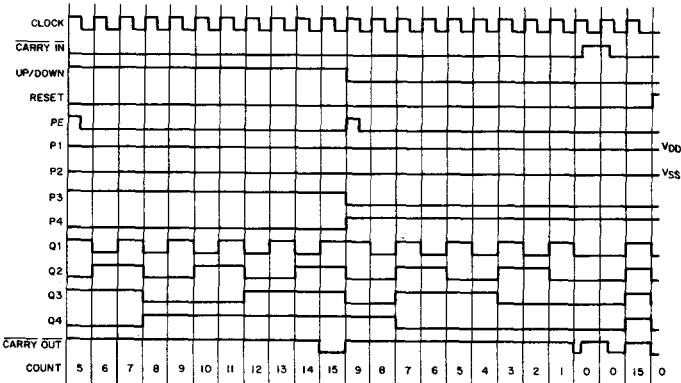
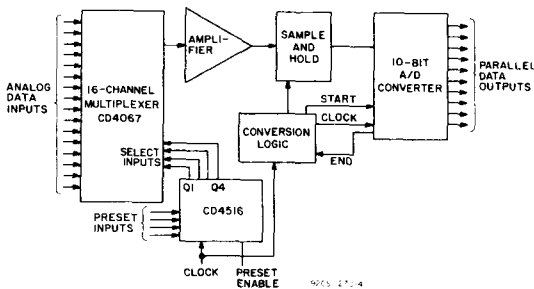

Fig. 16 — Timing diagram for CD4516B.

92CM-27009B



This acquisition system can be operated in the random access mode by jamming in the channel number at the present inputs, or in the sequential mode by clocking the CD4516B.

Fig. 17 — Typical 16-channel, 10-bit data acquisition system.

CL	CT	U/D	PE	R	ACTION
X	1	X	0	0	NO COUNT
↓	0	1	0	0	COUNT UP
↓	0	0	0	0	COUNT DOWN
X	X	X	1	0	PRESET
X	X	X	X	1	RESET

X = DON'T CARE  
TRUTH TABLE

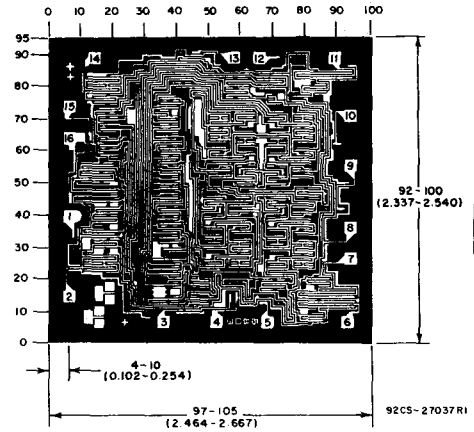

Dimensions and Pad Layout for CD4510BH.

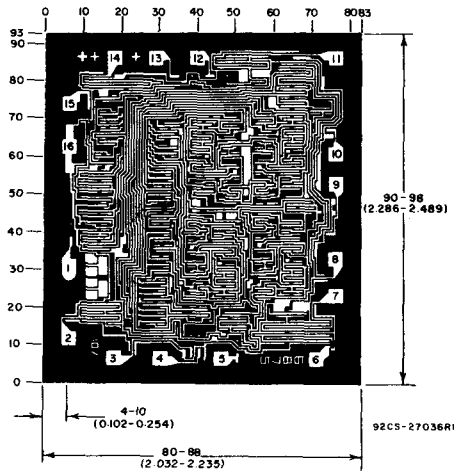

Dimensions and Pad Layout for CD4516BH.

The photographs and dimensions of each CMOS chip represent a chip when it is part of the wafer. When the wafer is separated into individual chips, the angle of cleavage may vary with respect to the chip face for different chips. The actual dimensions of the isolated chip, therefore, may differ slightly from the nominal dimensions shown. The user should consider a tolerance of -3 mils to +16 mils applicable to the nominal dimensions shown.

Dimensions in parentheses are in millimeters and are derived from the basic inch dimensions as indicated. Grid graduations are in mils ( $10^{-3}$  inch).

# CD4510B, CD4516B Types

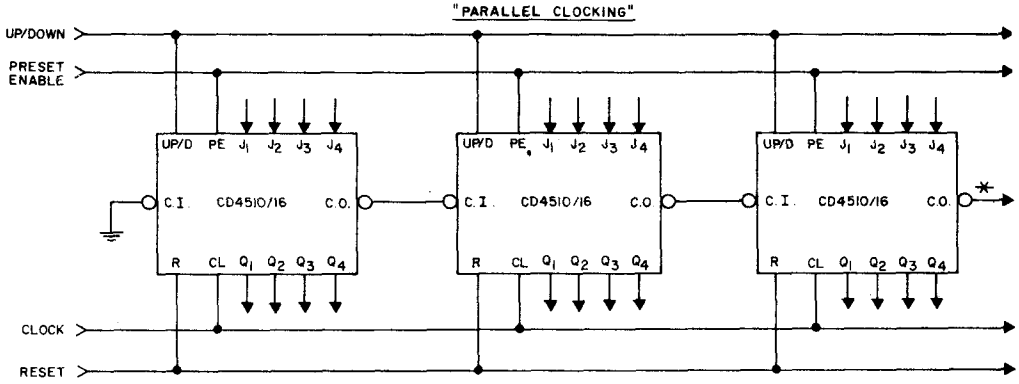

\* CARRY OUT lines at the 2nd, 3rd, etc., stages may have a negative-going glitch pulse resulting from differential delays of different CD4510/16 IC's. These negative-going glitches do not affect proper CD4510/16 operation. However, if the CARRY OUT signals are used to trigger other edge-sensitive logic devices, such as FF's or counters, the CARRY OUT signals should be gated with the clock signal using a 2-input OR gate such as CD4071B.

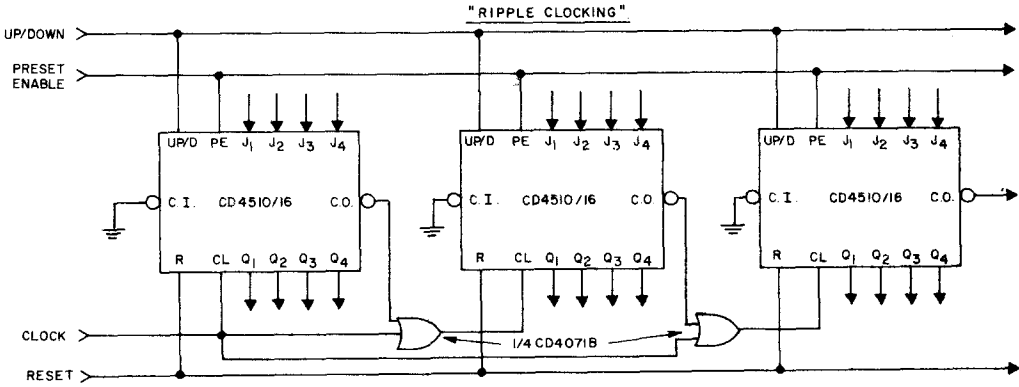

**RIPPLE CLOCKING MODE:**  
THE UP/DOWN CONTROL CAN BE CHANGED AT ANY COUNT. THE ONLY RESTRICTION ON CHANGING THE UP/DOWN CONTROL IS THAT THE CLOCK INPUT TO THE FIRST COUNTING STAGE MUST BE "HIGH".

For cascading counters operating in a fixed up-count or down-count mode, the OR gates are not required between stages, and C.O. is connected directly to the CL input of the next stage with C.I. grounded.

92CL-17194R5

Fig. 18 — Cascading counter packages.



# CMOS BCD-to-7-Segment Latch Decoder Drivers

High-Voltage Types (20-Volt Rating)

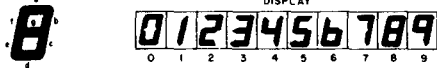

92CS-25087

The CD4511B types are BCD-to-7-segment latch decoder drivers constructed with CMOS logic and n-p-n bipolar transistor output devices on a single monolithic structure. These devices combine the low quiescent power dissipation and high noise immunity features of RCA CMOS with n-p-n bipolar output transistors capable of sourcing up to 25 mA. This capability allows the CD4511B types to drive LED's and other displays directly.

Lamp Test ( $\overline{LT}$ ), Blanking ( $\overline{BL}$ ), and Latch Enable or Strobe inputs are provided to test the display, shut off or intensity-modulate it, and store or strobe a BCD code, respectively. Several different signals may be multiplexed and displayed when external multiplexing circuitry is used. The CD4511B is supplied in 16-lead hermetic dual-in-line ceramic packages (D and F suffixes), 16-lead dual-in-line plastic packages (E suffix), 16-lead ceramic flat packages (K suffix), and in chip form (H suffix).

These devices are similar to the type MC14511.

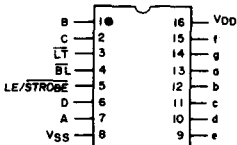

TOP VIEW

92CS-25084R1

CD4511B  
TERMINAL ASSIGNMENT

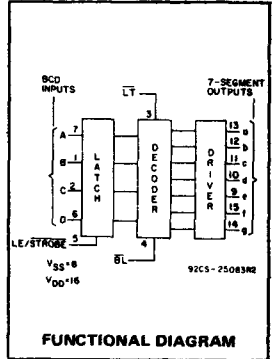

FUNCTIONAL DIAGRAM

**Features:**

- High-output-sourcing capability . . . . . up to 25 mA
- Input latches for BCD Code storage
- Lamp Test and Blanking capability
- 7-segment outputs blanked for BCD input codes > 1001
- 100% tested for quiescent current at 20 V
- Max. input current of 1  $\mu$ A at 18 V, over full package-temperature range, 100 nA at 18 V and 25°C
- 5-V, 10-V, and 15-V parametric ratings

**Applications:**

- Driving common-cathode LED displays
- Multiplexing with common-cathode LED displays
- Driving incandescent displays
- Driving low-voltage fluorescent displays

**MAXIMUM RATINGS, Absolute-Maximum Values:**

DC SUPPLY-VOLTAGE RANGE, ( $V_{DD}$ ) (Voltages referenced to $V_{SS}$ Terminal)	-0.5 to +20 V
INPUT VOLTAGE RANGE, ALL INPUTS	-0.5 to $V_{DD}$ +0.5 V
DC INPUT CURRENT, ANY ONE INPUT	$\pm$ 10 mA
POWER DISSIPATION PER PACKAGE ( $P_D$ ):	
For $T_A = -40$ to $+60^\circ\text{C}$ (PACKAGE TYPE E)	500 mW
For $T_A = +60$ to $+85^\circ\text{C}$ (PACKAGE TYPE E)	Derate Linearly at 12 mW/ $^\circ\text{C}$ to 200 mW
For $T_A = -55$ to $+100^\circ\text{C}$ (PACKAGE TYPES D, F, K)	500 mW
For $T_A = +100$ to $+125^\circ\text{C}$ (PACKAGE TYPES D, F, K)	Derate Linearly at 12 mW/ $^\circ\text{C}$ to 200 mW
DEVICE DISSIPATION PER OUTPUT TRANSISTOR	
FOR $T_A =$ FULL PACKAGE-TEMPERATURE RANGE (All Package Types)	100 mW
OPERATING-TEMPERATURE RANGE ( $T_A$ ):	
PACKAGE TYPES D, F, K, H	-55 to $+125^\circ\text{C}$
PACKAGE TYPE E	-40 to $+85^\circ\text{C}$
STORAGE TEMPERATURE RANGE ( $T_{stg}$ )	-85 to $+150^\circ\text{C}$
LEAD TEMPERATURE (DURING SOLDERING):	
At distance 1/16 $\pm$ 1/32 inch (1.59 $\pm$ 0.79 mm) from case for 10 s max.	$+265^\circ\text{C}$

**OPERATING CONDITIONS AT  $T_A = 25^\circ\text{C}$  Unless Otherwise Specified**

For maximum reliability, nominal operating conditions should be selected so that operation is always within the following ranges

Characteristic	$V_{DD}$	Min.	Max.	Units
Supply-Voltage Range ( $T_A$ ): (Full Package-Temperature Range)	-	3	18	V
Set-Up Time ( $t_S$ )	5	150	-	ns
	10	70	-	ns
	15	40	-	ns
Hold Time ( $t_H$ )	5	0	-	ns
	10	0	-	ns
	15	0	-	ns
Strobe Pulse Width ( $t_W$ )	5	400	-	ns
	10	160	-	ns
	15	100	-	ns

# CD4511B Types

## STATIC ELECTRICAL CHARACTERISTICS

Characteristic	Conditions				Limits at Indicated Temperatures (°C)								Units
	$I_{OH}$ (mA)	$V_o$ (V)	$V_{IN}$ (V)	$V_{DD}$ (V)	Values at -55, +25, +125 for D, F, K, H, Packages Values at -40, +25, +85 for E Packages								
					-55	-40	+85	+125	+25				
					Min.	Typ.	Max.						
Quiescent Device Current: $I_{DD}$ Max.	-	-	-	5	5	5	150	150	-	0.04	5	$\mu A$	
	-	-	-	10	10	10	300	300	-	0.04	10		
	-	-	-	15	20	20	600	600	-	0.04	20		
Output Voltage: Low-Level $V_{OL}$ Max.	-	-	0.5	5	0.05				-	0	0.05	V	
	-	-	0.10	10	0.05				-	0	0.05		
	-	-	0.15	15	0.05				-	0	0.05		
High-Level $V_{OH}$ Min.	-	-	0.5	5	4	4	4.2	4.2	4.1	4.55	-	V	
	-	-	0.10	10	9	9	9.2	9.2	9.1	9.55	-		
	-	-	0.15	15	14	14	14.2	14.2	14.1	14.55	-		
Input Low Voltage, $V_{IL}$ Max.	-	0.5, 3.8	-	5	1.5				-	-	1.5	V	
	-	1.8, 8	-	10	3				-	-	3		
	-	1.5, 13.8	-	15	4				-	-	4		
Input High Voltage, $V_{IH}$ Min.	-	0.5, 3.8	-	5	3.5				3.5	-	-	V	
	-	1.8, 8	-	10	7				7	-	-		
	-	1.5, 13.8	-	15	11				11	-	-		
Output Drive Voltage: High Level $V_{OH}$ Min.	0	-	-	5	4.0	4.0	4.20	4.20	4.10	4.55	-	V	
	5	-	-		-	-	-	-	-	4.25	-		
	10	-	-		3.80	3.80	3.90	3.90	3.90	4.10	-		
	15	-	-		-	-	3.50	3.50	-	3.95	-		
	20	-	-		3.55	3.55	3.30	-	3.40	3.75	-		
	25	-	-		3.40	3.40	-	-	3.10	3.55	-		
	0	-	-	10	9.0	9.0	9.20	9.20	9.10	9.55	-	V	
	5	-	-		-	-	-	-	-	9.25	-		
	10	-	-		8.85	8.85	9.00	9.00	9.00	9.15	-		
	15	-	-		-	-	-	-	-	9.05	-		
	20	-	-		8.70	8.70	8.40	8.40	8.60	8.90	-		
	25	-	-		8.60	8.60	-	-	8.30	8.75	-		
0	-	-	15	14.0	14.0	14.20	14.20	14.10	14.55	-	V		
5	-	-		-	-	-	-	-	14.30	-			
10	-	-		13.90	13.90	14.0	14.0	14.0	14.20	-			
15	-	-		-	-	-	-	-	14.10	-			
20	-	-		13.75	13.75	13.50	13.50	13.70	13.95	-			
25	-	-		13.65	13.65	-	-	13.50	13.80	-			
Output Low (Sink) Current, $I_{OL}$ Min.	-	0.4	0.5	5	0.64	0.61	0.42	0.36	0.51	1	-	mA	
	-	0.5	0.10	10	1.6	1.5	1.1	0.9	1.3	2.6	-		
	-	1.5	0.15	15	4.2	4	2.8	2.4	3.4	6.8	-		
Input Current, $I_{IN}$ Max.	-	0.18	0.18	18	$\pm 0.1$	$\pm 0.1$	$\pm 1$	$\pm 1$	-	$\pm 10^{-5}$	$\pm 0.1$	$\mu A$	

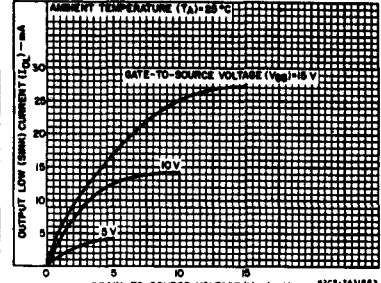

Fig. 1 - Typical output low (sink) current characteristics.

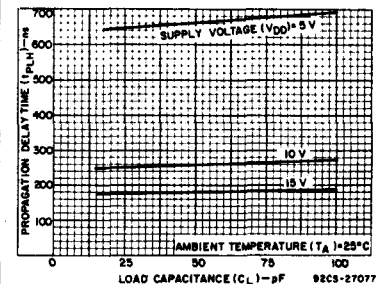

Fig. 2 - Typical data-to-output, low-to-high level propagation delay time as a function of load capacitance.

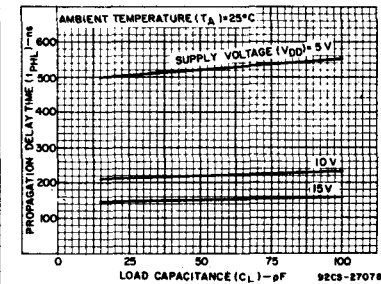

Fig. 3 - Typical data-to-output, high-to-low level propagation delay time as a function of load capacitance.

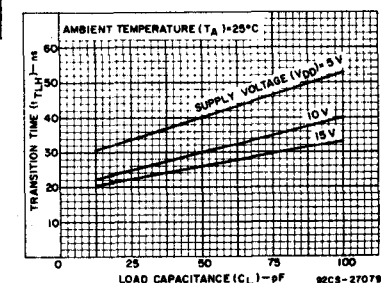

Fig. 4 - Typical low-to-high level transition time as a function of load capacitance.

# CD4511B Types

DYNAMIC ELECTRICAL CHARACTERISTICS at  $T_A = 25^\circ\text{C}$ , Input  $t_r, t_f = 20\text{ ns}$ ,  
 $C_L = 50\text{ pF}$ ,  $R_L = 200\text{ k}\Omega$

CHARACTERISTIC	Test Conditions	LIMITS All Packages			UNITS
		V <sub>DD</sub> Volts	Min.	Typ.	
Propagation Delay Time: (Data) High-to-Low Level, $t_{pHL}$	5	—	520	1040	ns
	10	—	210	420	
	15	—	150	300	
Low-to-High Level, $t_{pLH}$	5	—	660	1320	ns
	10	—	260	520	
	15	—	180	360	
Propagation Delay Time: (BL) High-to-Low Level, $t_{pHL}$	5	—	350	700	ns
	10	—	175	350	
	15	—	125	250	
Low-to-High Level, $t_{pLH}$	5	—	400	800	ns
	10	—	175	350	
	15	—	150	300	
Propagation Delay Time: (LT) High-to-Low Level, $t_{pHL}$	5	—	250	500	ns
	10	—	125	250	
	15	—	85	170	
Low-to-High Level, $t_{pLH}$	5	—	150	300	ns
	10	—	75	150	
	15	—	50	100	
Transition Time: Low-to-High Level, $t_{TLH}$	5	—	40	80	ns
	10	—	30	60	
	15	—	25	50	
High-to-Low Level, $t_{THL}$	5	—	125	310	ns
	10	—	75	185	
	15	—	65	160	
Minimum Set-Up Time, $t_S$	5	150	75	—	ns
	10	70	35	—	
	15	40	20	—	
Minimum Hold Time, $t_H$	5	0	-75	—	ns
	10	0	-35	—	
	15	0	-20	—	
Strobe Pulse Width, $t_W$	5	400	200	—	ns
	10	160	80	—	
	15	100	50	—	
Input Capacitance, $C_{IN}$		—	5	7.5	pF

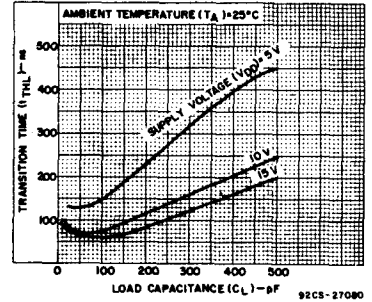

Fig. 5 - Typical high-to-low transition time as a function of load capacitance.

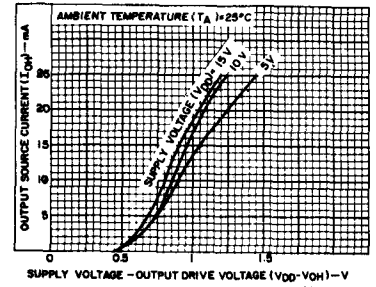

Fig. 6 - Typical voltage drop ( $V_{DD}$  to output) vs. output source current as a function of supply.

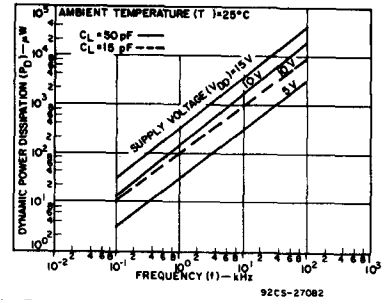

Fig. 7 - Typical dynamic power dissipation characteristics.

# CD4511B Types

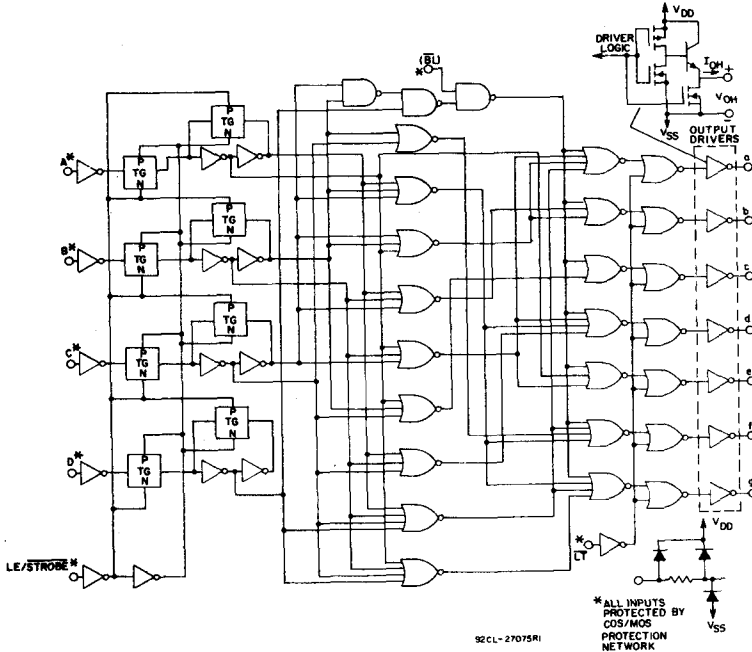

Fig. 8 - Logic diagram.

TRUTH TABLE

LE	BI	LT	D	C	B	A	a	b	c	d	e	f	g	Display
X	X	0	X	X	X	X	1	1	1	1	1	1	1	8
X	0	1	X	X	X	X	0	0	0	0	0	0	0	Blank
0	1	1	0	0	0	0	1	1	1	1	1	1	0	0
0	1	1	0	0	0	1	0	1	1	0	0	0	0	1
0	1	1	0	0	1	0	1	1	0	1	1	0	1	2
0	1	1	0	0	1	1	1	1	1	0	0	0	1	3
0	1	1	0	1	0	0	0	1	1	0	0	1	1	4
0	1	1	0	1	0	1	1	0	1	1	0	1	1	5
0	1	1	0	1	1	0	0	0	1	1	1	1	1	6
0	1	1	1	0	0	0	1	1	1	0	0	0	0	7
0	1	1	1	0	0	1	1	1	1	1	1	1	1	8
0	1	1	1	0	0	1	1	1	0	0	1	1	1	9
0	1	1	1	0	1	0	0	0	0	0	0	0	0	Blank
0	1	1	1	0	1	1	0	0	0	0	0	0	0	Blank
0	1	1	1	1	0	0	0	0	0	0	0	0	0	Blank
0	1	1	1	1	0	1	0	0	0	0	0	0	0	Blank
0	1	1	1	1	1	0	0	0	0	0	0	0	0	Blank
0	1	1	1	1	1	1	0	0	0	0	0	0	0	Blank
0	1	1	1	1	1	1	1	0	0	0	0	0	0	Blank
1	1	1	X	X	X	X	*	*	*	*	*	*	*	*

X = Don't Care \* Depends on BCD code previously applied when LE = 0  
 Note: Display is blank for all illegal input codes (BCD > 1001).

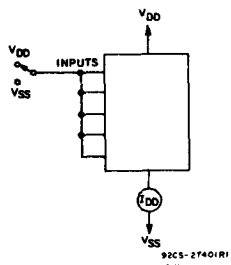

Fig. 9 - Quiescent device current.

### TEST CIRCUITS

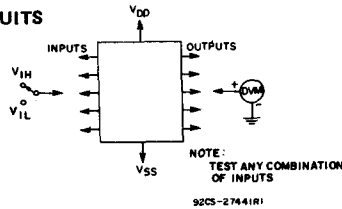

Fig. 10 - Input voltage.

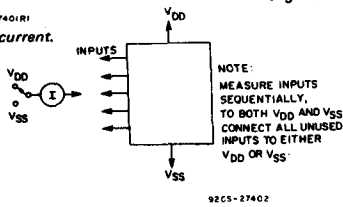

Fig. 11 - Input current.

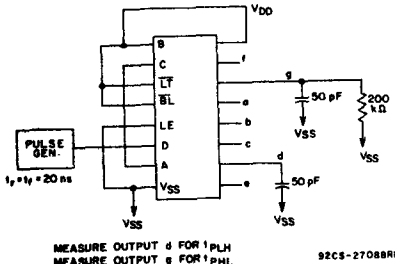

Fig. 12 - Data propagation delay.

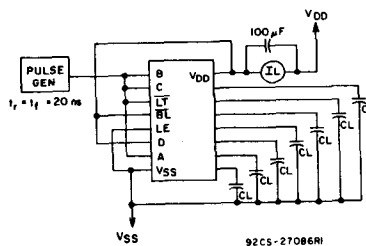

Fig. 13 - Dynamic power dissipation.

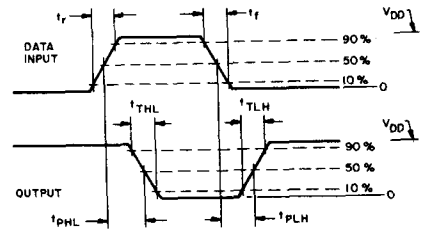

Fig. 14 - Dynamic waveforms.

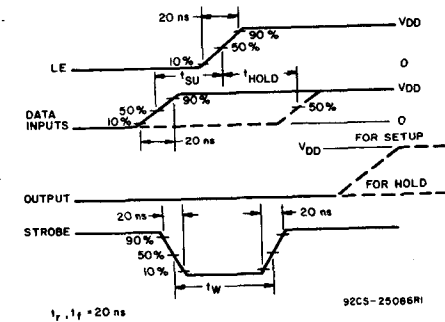
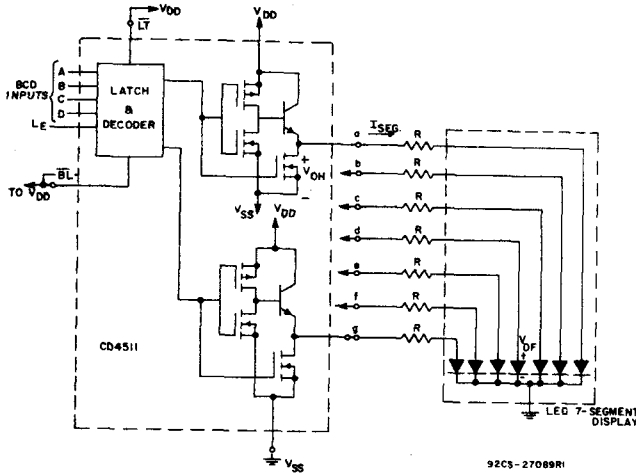

Fig. 14 - Dynamic waveforms.

# CD4511B Types

## APPLICATIONS Interfacing with Various Displays



Duty Cycle = 100%

$I_{SEG} = I_{DIODE_{AVG}} = 20 \text{ mA}$  at Luminous Intensity/Segment = 250 microcandles

$$R = \frac{V_{OH} - V_{DF}}{I_{SEG}}$$

Fig. 15 — Driving common-cathode 7-segment LED displays (example Hewlett-Packard 5082-7740).

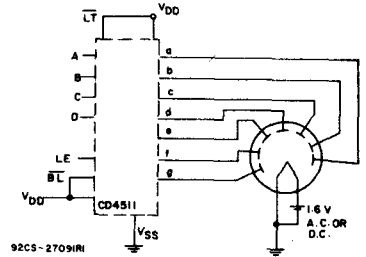

A medium-brightness intensity display can be obtained with low-voltage fluorescent displays such as the Tung-Sol Digivac S/G\*\* Series.

\*\*Trademark Tung-Sol Division Wagner Electric Co.

Fig. 16 — Driving low-voltage fluorescent displays.

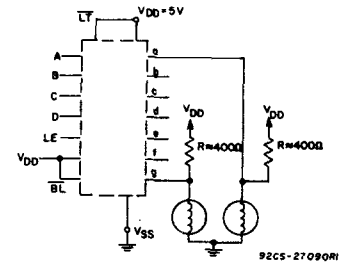

### 2 of 7 Segments Shown Connected

Resistors R from  $V_{DD}$  to each 7-segment driver output are chosen to keep all Numitron segments slightly on and warm.

Fig. 17 — Driving incandescent displays (RCA Numitron DR2000 series displays).

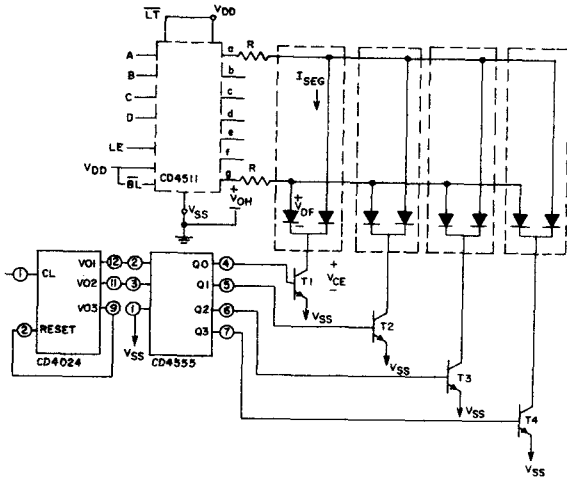

### Multiplexing Scheme Showing 2 of 7 Segments Connected

Transistors  $T_1 - T_4$  (RCA-2N3053 or 2N2102) have  $I_C$  Max. rating  $> 7 \times I_{SEG}$

Duty Cycle = 25%

$$I_{SEG} = I_{DIODE_{AVG}} \times 4$$

$$R = \frac{(V_{OH} - V_{DF} - V_{CE})}{I_{SEG}}$$

All unused inputs on CD4555 are connected to  $V_{DD}$  or  $V_{SS}$ .

Fig. 18 — Multiplexing with common-cathode 7-segment LED displays (example Hewlett-Packard 5082-7404 4 character display or 4 discrete Monosanto Man 3 displays).

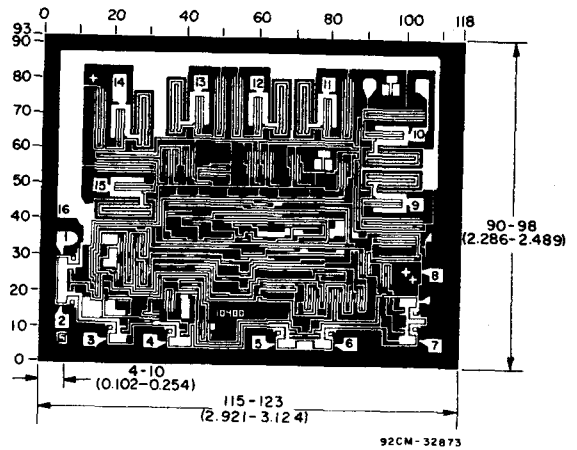

### Dimensions and pad layout for CD4511B chip.

The photographs and dimensions of each CMOS chip represent a chip when it is part of the wafer. When the wafer is separated into individual chips, the angle of cleavage may vary with respect to the chip face for different chips. The actual dimensions of the isolated chip, therefore, may differ slightly from the nominal dimensions shown. The user should consider a tolerance of  $-3$  mils to  $+16$  mils applicable to the nominal dimensions shown.

Dimensions in parentheses are in millimeters and are derived from the basic inch dimensions as indicated. Grid graduations are in mils ( $10^{-3}$  inch).

# CD4512B Types

## CMOS 8-Channel Data Selector

High-Voltage Types (20-Volt Rating)

The RCA-CD4512B is an 8-channel data selector featuring a three-state output that can interface directly with, and drive, data lines of bus-oriented systems.

The CD4512B-series types are supplied in 16-lead hermetic dual-in-line ceramic packages (D and F suffixes), 16-lead dual-in-line plastic packages (E suffix), 16-lead ceramic flat packages (K suffix), and in chip form (H suffix).

### Features:

- 3-state output
- Standardized, symmetrical output characteristics
- 100% tested for quiescent current at 20 V
- 5-V, 10-V, and 15-V parametric ratings
- Maximum input current of 1  $\mu$ A at 18 V over full package-temperature range; 100 nA at 18 V and 25°C
- Noise margin (over full package-temperature range):
  - 1 V at  $V_{DD} = 5$  V
  - 2 V at  $V_{DD} = 10$  V
  - 2.5 V at  $V_{DD} = 15$  V

■ Meets all requirements of JEDEC Tentative Standard No. 13A, "Standard Specifications for Description of 'B' Series CMOS Devices"

### Applications:

- Digital multiplexing
- Number-sequence generation
- Signal gating

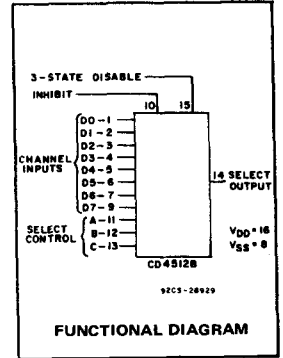

### RECOMMENDED OPERATING CONDITIONS

For maximum reliability, nominal operating conditions should be selected so that operation is always within the following ranges:

CHARACTERISTIC	LIMITS		UNITS
	MIN.	MAX.	
Supply-Voltage Range (For $T_A$ = Full Package Temperature Range)	3	18	V

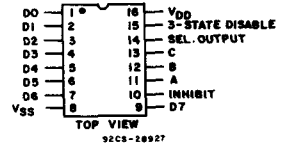

TERMINAL ASSIGNMENT

### TRUTH TABLE

SEL. CONT.			INH	3-STATE DISABLE	SEL. OUTPUT
A	B	C			
0	0	0	0	0	D0
1	0	0	0	0	D1
0	1	0	0	0	D2
1	1	0	0	0	D3
0	0	1	0	0	D4
1	0	1	0	0	D5
0	1	1	0	0	D6
1	1	1	0	0	D7
X	X	X	1	0	0
X	X	X	X	1	High Z

1 = High Level    0 = Low Level  
X = Don't Care

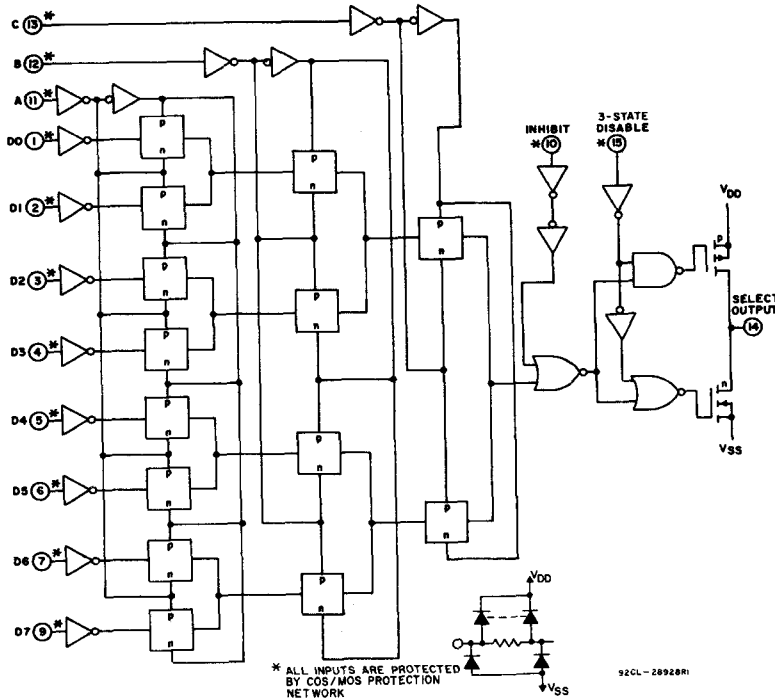

Fig. 1 - Logic diagram.

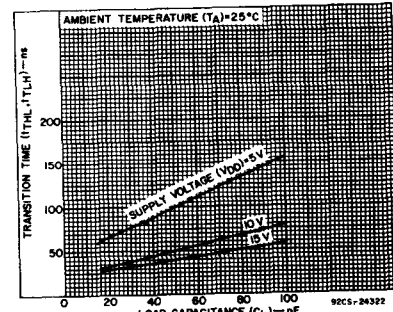

Fig. 2 - Typical transition time as a function of load capacitance.

# CD4512B Types

## MAXIMUM RATINGS, Absolute-Maximum Values:

DC SUPPLY-VOLTAGE RANGE, (V <sub>DD</sub> ) (Voltages referenced to V <sub>SS</sub> Terminal)	-0.5 to +20 V
INPUT VOLTAGE RANGE, ALL INPUTS	-0.5 to V <sub>DD</sub> +0.5 V
DC INPUT CURRENT, ANY ONE INPUT	±10 mA
POWER DISSIPATION PER PACKAGE (P <sub>D</sub> ):	
For T <sub>A</sub> = -40 to +60°C (PACKAGE TYPE E)	500 mW
For T <sub>A</sub> = +60 to +85°C (PACKAGE TYPE E)	Derate Linearly at 12 mW/°C to 200 mW
For T <sub>A</sub> = -55 to +100°C (PACKAGE TYPES D, F, K)	500 mW
For T <sub>A</sub> = +100 to +125°C (PACKAGE TYPES D, F, K)	Derate Linearly at 12 mW/°C to 200 mW
DEVICE DISSIPATION PER OUTPUT TRANSISTOR:	
For T <sub>A</sub> = FULL PACKAGE-TEMPERATURE RANGE (All Package Types)	100 mW
OPERATING-TEMPERATURE RANGE (T <sub>A</sub> ):	
PACKAGE TYPES D, F, K, H	-55 to +125°C
PACKAGE TYPE E	-40 to +85°C
STORAGE TEMPERATURE RANGE (T <sub>stg</sub> )	-65 to +150°C
LEAD TEMPERATURE (DURING SOLDERING):	
At distance 1/16 ± 1/32 inch (1.59 ± 0.79 mm) from case for 10 s max.	+265°C

## STATIC ELECTRICAL CHARACTERISTICS

CHARACTERISTIC	CONDITIONS			LIMITS AT INDICATED TEMPERATURES (°C)							UNITS
				Values at -55, +25, +125 Apply to D, F, K, H, Packages Values at -40, +25, +85 Apply to E Package							
				V <sub>O</sub> (V)	V <sub>IN</sub> (V)	V <sub>DD</sub> (V)	-55	-40	+85	+125	
Min.	Typ.	Max.									
Quiescent Device Current, I <sub>DD</sub> Max.	-	0.5	5	5	5	150	150	-	0.04	5	μA
	-	0.10	10	10	10	300	300	-	0.04	10	
	-	0.15	15	20	20	600	600	-	0.04	20	
	-	0.20	20	100	100	3000	3000	-	0.08	100	
Output Low (Sink) Current I <sub>OL</sub> Min.	0.4	0.5	5	0.64	0.61	0.42	0.36	0.51	1	-	mA
	0.5	0.10	10	1.6	1.5	1.1	0.9	1.3	2.6	-	
	1.5	0.15	15	4.2	4	2.8	2.4	3.4	6.8	-	
Output High (Source) Current, I <sub>OH</sub> Min.	4.6	0.5	5	-0.64	-0.61	-0.42	-0.36	-0.51	-1	-	mA
	2.5	0.5	5	-2	-1.8	-1.3	-1.15	-1.6	-3.2	-	
	9.5	0.10	10	-1.6	-1.5	-1.1	-0.9	-1.3	-2.6	-	
	13.5	0.15	15	-4.2	-4	-2.8	-2.4	-3.4	-6.8	-	
Output Voltage: Low-Level, V <sub>OL</sub> Max.	-	0.5	5	0.05				-	0	0.05	V
	-	0.10	10	0.05				-	0	0.05	
	-	0.15	15	0.05				-	0	0.05	
Output Voltage: High-Level, V <sub>OH</sub> Min.	-	0.5	5	4.95				4.95	5	-	V
	-	0.10	10	9.95				9.95	10	-	
	-	0.15	15	14.95				14.95	15	-	
Input Low Voltage V <sub>IL</sub> Max.	0.5, 4.5	-	5	1.5				-	-	1.5	V
	1.9	-	10	3				-	-	3	
	1.5, 13.5	-	15	4				-	-	4	
Input High Voltage, V <sub>IH</sub> Min.	0.5, 4.5	-	5	3.5				3.5	-	-	V
	1.9	-	10	7				7	-	-	
	1.5, 13.5	-	15	11				11	-	-	
Input Current I <sub>IN</sub> Max.	-	0.18	18	±0.1	±0.1	±1	±1	-	±10 <sup>-5</sup>	±0.1	μA
3-State Output Leakage Current I <sub>OUT</sub> Max.	0.18	0.18	18	±0.4	±0.4	±12	±12	-	±10 <sup>-4</sup>	±0.4	μA

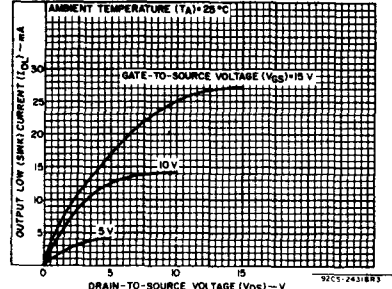

Fig. 3 - Typical output low (sink) current characteristics.

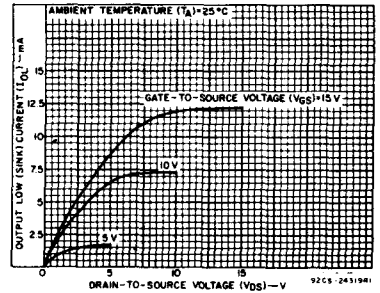

Fig. 4 - Minimum output low (sink) current characteristics.

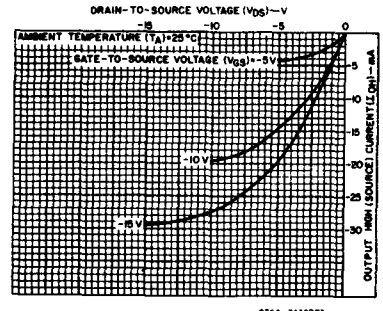

Fig. 5 - Typical output high (source) current characteristics.

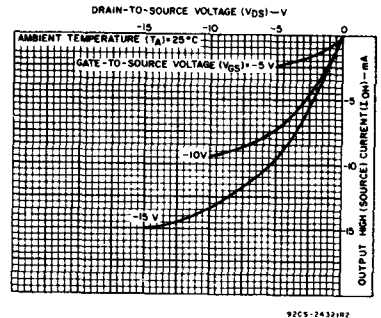

Fig. 6 - Minimum output high (source) current characteristics.

# CD4512B Types

DYNAMIC ELECTRICAL CHARACTERISTICS at  $T_A = 25^\circ\text{C}$ , Input  $t_r, t_f = 20\text{ ns}$ ,  $C_L = 50\text{ pF}$ ,  $R_L = 200\text{ k}\Omega$

CHARACTERISTIC	TEST CONDITIONS	LIMITS		UNITS
	$V_{DD}$ (V)	Typ.	Max.	
Propagation Delay Time, $t_{pHL}$ , $t_{pLH}$ Inhibit to Output	5	140	280	ns
	10	70	140	
	15	50	100	
"A" Select to Output	5	200	400	
	10	85	170	
	15	60	120	
Data to Output	5	180	360	
	10	75	150	
	15	55	110	
3-State Disable Delay Time: $t_{PZL}$ , $t_{PLZ}$ , $t_{PHZ}$ , $t_{PZH}$	5	60	120	ns
Transition Time, $t_{THL}$ , $t_{TLH}$	10	30	60	
	15	20	40	
	5	100	200	ns
Input Capacitance, $C_{IN}$ (Any Input)	10	50	100	
	15	40	80	
	5	5	7.5	pF

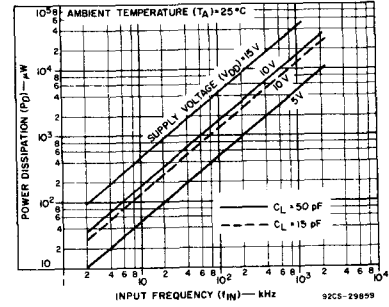

Fig. 7 - Typical dynamic power dissipation as a function of frequency.

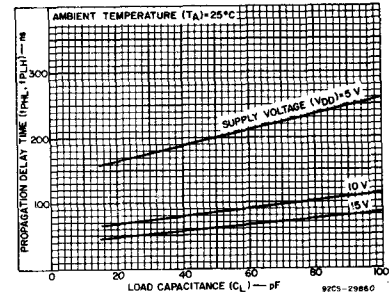

Fig. 8 - Typical propagation delay time as a function of load capacitance ("A" select to output).

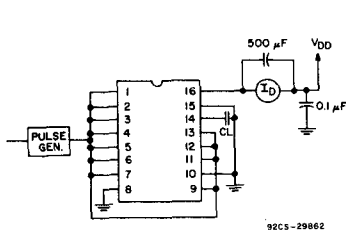

Fig. 9 - Dynamic power dissipation test circuit.

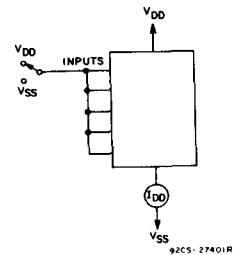

Fig. 10 - Quiescent device current test circuit.

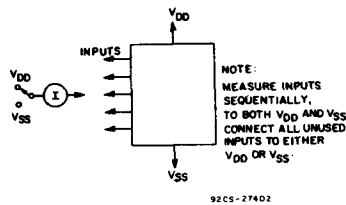

Fig. 11 - Input current test circuit.

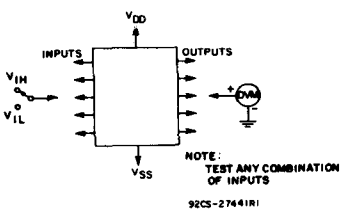
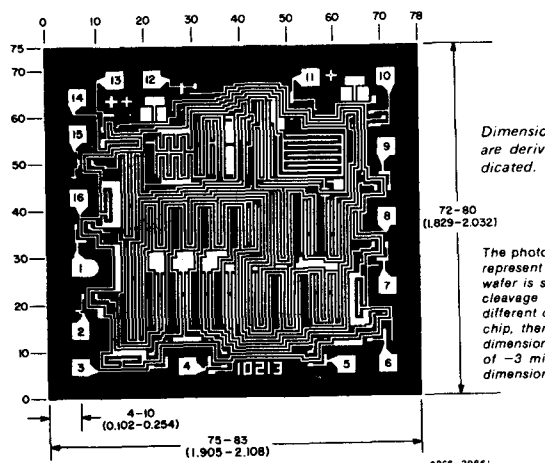

Fig. 12 - Input voltage test circuit.



Dimensions in parentheses are in millimeters and are derived from the basic inch dimensions as indicated. Grid graduations are in mils ( $10^{-3}$  inch).

The photographs and dimensions of each CMOS chip represent a chip when it is part of the wafer. When the wafer is separated into individual chips, the angle of cleavage may vary with individual chips, the angle of cleavage for different chips. The actual dimensions of the isolated chip, therefore, may differ slightly from the nominal dimensions shown. The user should consider a tolerance of  $-3\text{ mils}$  to  $+16\text{ mils}$  applicable to the nominal dimensions shown.

Dimensions and pad layout for CD4512BH



# CMOS 4-Bit Latch/4-to-16

## Line Decoders

High-Voltage Types (20-Volt Rating)  
 CD4514B Output "High" on Select  
 CD4515B Output "Low" on Select

The RCA-CD4514B and -CD4515B consist of a 4-bit strobed latch and a 4-to-16-line decoder. The latches hold the last input data presented prior to the strobe transition from 1 to 0. Inhibit control allows all outputs to be placed at 0 (CD4514B) or 1 (CD4515B) regardless of the state of the data or strobe inputs.

The decode truth table indicates all combinations of data inputs and appropriate selected outputs. These devices are similar to industry types MC14514 and MC14515.

The CD4514B and CD4515B types are supplied in 24-lead hermetic dual-in-line ceramic packages (D and F suffixes), 24-lead dual-in-line plastic packages (E suffix), 24-lead ceramic flat packages (K suffix), and in chip form (H suffix).

### Features:

- Strobed input latch
- Inhibit control
- 100% tested for quiescent current at 20 V over full package-temperature range; 100 nA at 18 V and 25°C
- Noise margin (over full package temperature range):
  - 1 V at  $V_{DD} = 5\text{ V}$
  - 2 V at  $V_{DD} = 10\text{ V}$
  - 2.5 V at  $V_{DD} = 15\text{ V}$
- 5-V, 10-V, and 15-V parametric ratings
- Standardized, symmetrical output characteristics.
- Meets all requirements of JEDEC Tentative Standard No. 13A, "Standard Specifications for Description of 'B' Series CMOS Devices"

### Applications:

- Digital multiplexing
- Address decoding
- Hexadecimal/BCD decoding
- Program-counter decoding
- Control decoder

### MAXIMUM RATINGS, Absolute-Maximum Values:

DC SUPPLY-VOLTAGE RANGE, ( $V_{DD}$ ) (Voltages referenced to $V_{SS}$ Terminal)	-0.5 to +20 V
INPUT VOLTAGE RANGE, ALL INPUTS	-0.5 to $V_{DD} + 0.5\text{ V}$
DC INPUT CURRENT, ANY ONE INPUT	$\pm 10\text{ mA}$
POWER DISSIPATION PER PACKAGE ( $P_D$ ):	
For $T_A = -40$ to $+60^\circ\text{C}$ (PACKAGE TYPE E)	500 mW
For $T_A = +60$ to $+85^\circ\text{C}$ (PACKAGE TYPE E)	Derate Linearly at $12\text{ mW}/^\circ\text{C}$ to 200 mW
For $T_A = -55$ to $+100^\circ\text{C}$ (PACKAGE TYPES D, F, K)	500 mW
For $T_A = +100$ to $+125^\circ\text{C}$ (PACKAGE TYPES D, F, K)	Derate Linearly at $12\text{ mW}/^\circ\text{C}$ to 200 mW
DEVICE DISSIPATION PER OUTPUT TRANSISTOR	
For $T_A = \text{FULL PACKAGE-TEMPERATURE RANGE}$ (All Package Types)	100 mW
OPERATING-TEMPERATURE RANGE ( $T_A$ ):	
PACKAGE TYPES D, F, K, H	$-55$ to $+125^\circ\text{C}$
PACKAGE TYPE E	$-40$ to $+85^\circ\text{C}$
STORAGE TEMPERATURE RANGE ( $T_{stg}$ )	$-65$ to $+150^\circ\text{C}$
LEAD TEMPERATURE (DURING SOLDERING):	
At distance $1/16 \pm 1/32$ inch ( $1.59 \pm 0.79\text{ mm}$ ) from case for 10 s max.	$+265^\circ\text{C}$

**RECOMMENDED OPERATING CONDITIONS at  $T_A = 25^\circ\text{C}$ , Except as Noted.**  
 For maximum reliability, nominal operating conditions should be selected so that operation is always within the following ranges:

CHARACTERISTIC	$V_{DD}$ (V)	LIMITS		UNITS
		Min.	Max.	
Supply-Voltage Range (For $T_A = \text{Full Package-Temperature Range}$ )		3	18	V
Data Setup Time, $t_S$	5	150	—	ns
	10	70	—	
	15	40	—	
Strobe Pulse Width, $t_W$	5	250	—	ns
	10	100	—	
	15	75	—	

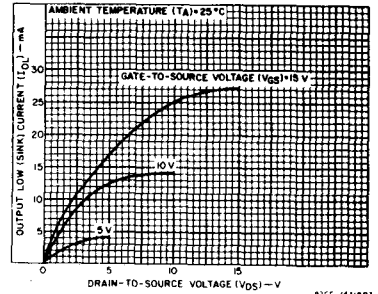
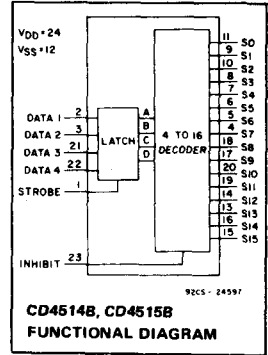

Fig. 1 — Typical output low (sink) current characteristics.

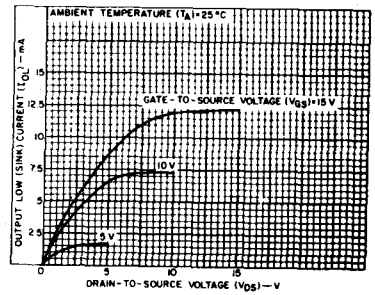

Fig. 2 — Minimum output low (sink) current characteristics.

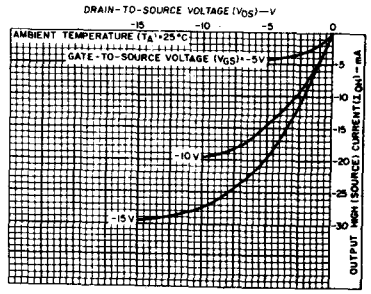

Fig. 3 — Typical output high (source) current characteristics.

# CD4514B, CD4515B Types

## STATIC ELECTRICAL CHARACTERISTICS

CHARACTERISTIC	CONDITIONS			LIMITS AT INDICATED TEMPERATURES (°C)							UNITS
	V <sub>O</sub> (V)	V <sub>IN</sub> (V)	V <sub>DD</sub> (V)	Values at -55, +25, +125 Apply to D, F, K, H Packages				Values at -40, +25, +85 Apply to E Package			
				-55	-40	+85	+125	+25			
				Min.	Typ.	Max.					
Quiescent Device Current, I <sub>DD</sub> Max.	-	0,5	5	5	5	150	150	-	0.04	5	μA
	-	0,10	10	10	10	300	300	-	0.04	10	
	-	0,15	15	20	20	600	600	-	0.04	20	
	-	0,20	20	100	100	3000	3000	-	0.08	100	
Output Low (Sink) Current I <sub>OL</sub> Min.	0.4	0,5	5	0.64	0.61	0.42	0.36	0.51	1	-	mA
	0.5	0,10	10	1.6	1.5	1.1	0.9	1.3	2.6	-	
	1.5	0,15	15	4.2	4	2.8	2.4	3.4	6.8	-	
Output High (Source) Current, I <sub>OH</sub> Min.	4.6	0,5	5	-0.64	-0.61	-0.42	-0.36	-0.51	-1	-	mA
	2.5	0,5	5	-2	-1.8	-1.3	-1.15	-1.6	-3.2	-	
	9.5	0,10	10	-1.6	-1.5	-1.1	-0.9	-1.3	-2.6	-	
	13.5	0,15	15	-4.2	-4	-2.8	-2.4	-3.4	-6.8	-	
Output Voltage: Low-Level, V <sub>OL</sub> Max.	-	0,5	5	0.05			-	0	0.05	-	V
	-	0,10	10	0.05			-	0	0.05	-	
	-	0,15	15	0.05			-	0	0.05	-	
Output Voltage: High-Level, V <sub>OH</sub> Min.	-	0,5	5	4.95			-	4.95	5	-	V
	-	0,10	10	9.95			-	9.95	10	-	
	-	0,15	15	14.95			-	14.95	15	-	
Input Low Voltage, V <sub>IL</sub> Max.	0.5, 4.5	-	5	1.5			-	-	1.5	-	V
	1, 9	-	10	3			-	-	3	-	
	1.5, 13.5	-	15	4			-	-	4	-	
Input High Voltage, V <sub>IH</sub> Min.	0.5, 4.5	-	5	3.5			-	3.5	-	-	V
	1, 9	-	10	7			-	7	-	-	
	1.5, 13.5	-	15	11			-	11	-	-	
Input Current I <sub>IN</sub> Max.	-	0,18	18	±0.1	±0.1	±1	±1	-	±10 <sup>-5</sup>	±0.1	μA

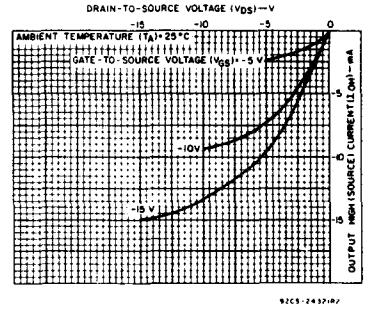

Fig. 4 - Minimum output high (source) current characteristics.

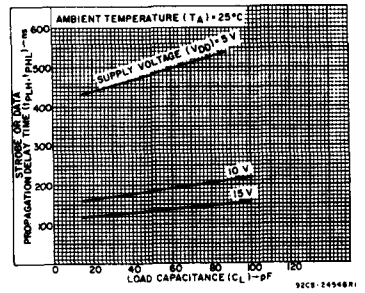

Fig. 5 - Typical strobe or data propagation delay time vs. load capacitance.

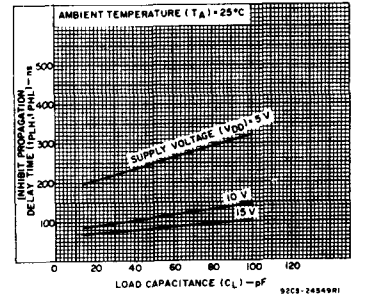

Fig. 6 - Typical inhibit propagation delay time vs. load capacitance.

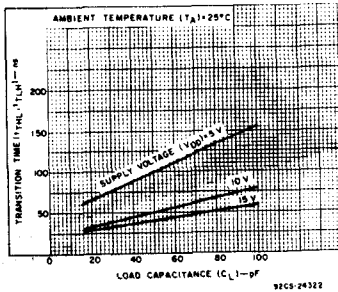

Fig. 7 - Typical low-to-high transition time vs. load capacitance.

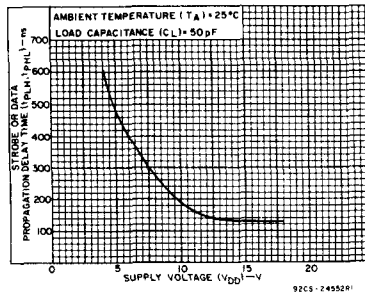

Fig. 8 - Typical strobe or data propagation delay time vs. supply voltage.

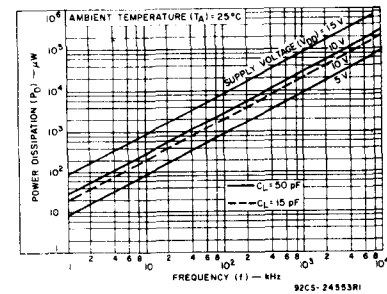

Fig. 9 - Typical power dissipation vs. frequency.

# CD4514B, CD4515B Types

DYNAMIC ELECTRICAL CHARACTERISTICS at  $T_A = 25^\circ\text{C}$ ; Input  $t_r, t_f = 20\text{ ns}$ ,  $C_L = 50\text{ pF}$ ,  $R_L = 200\text{ k}\Omega$

CHARACTERISTIC	TEST CONDITIONS	LIMITS			UNITS
		V <sub>DD</sub> V	Typ.	Max.	
Propagation Delay Time: $t_{pHL}$ , $t_{pLH}$ Strobe or Data		5	485	970	ns
		10	185	370	
		15	135	270	
Inhibit		5	250	500	ns
		10	110	220	
		15	85	170	
Transition Time, $t_{TLH}$ , $t_{THL}$		5	100	200	ns
		10	50	100	
		15	40	80	
Minimum Strobe Pulse Width, $t_W$		5	125	250	ns
		10	50	100	
		15	40	75	
Minimum Data Setup Time, $t_S$		5	75	150	ns
		10	35	70	
		15	20	40	
Input Capacitance, $C_{iN}$	Any Input	—	5	7.5	pF

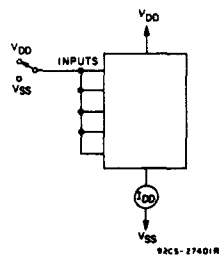

Fig. 10 — Quiescent device current test circuit.

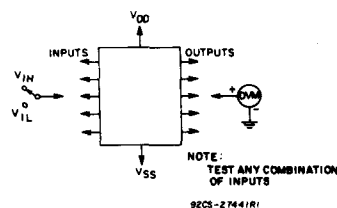

Fig. 11 — Input voltage test circuit.

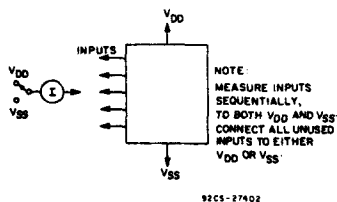

Fig. 12 — Input current test circuit.

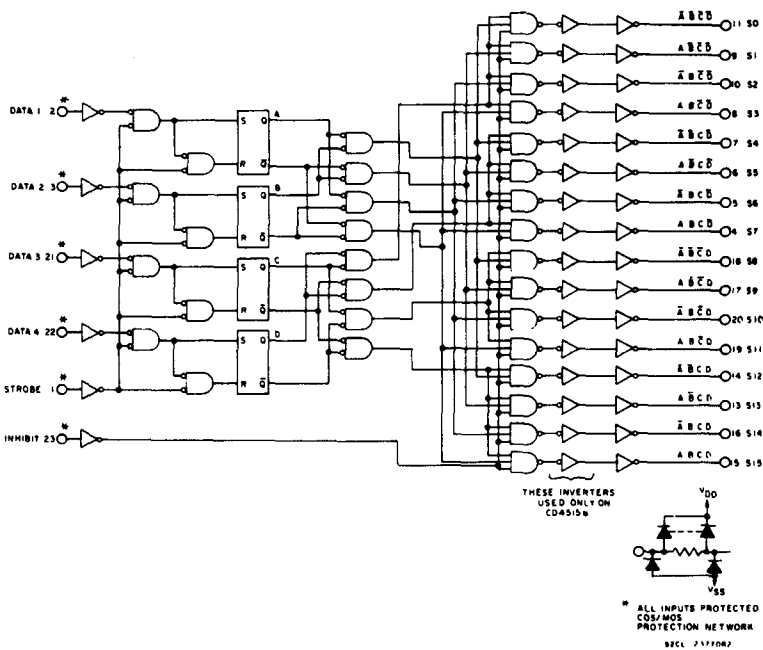

Fig. 13 — Logic diagram for CD4514B and CD4515B.

# CD4514B, CD4515B Types

DECODE TRUTH TABLE (Strobe = 1)

INHIBIT	DECODER INPUTS				SELECTED OUTPUT
	D	C	B	A	
0	0	0	0	0	S0
0	0	0	0	1	S1
0	0	0	1	0	S2
0	0	0	1	1	S3
0	0	1	0	0	S4
0	0	1	0	1	S5
0	0	1	1	0	S6
0	0	1	1	1	S7
0	1	0	0	0	S8
0	1	0	0	1	S9
0	1	0	1	0	S10
0	1	0	1	1	S11
0	1	1	0	0	S12
0	1	1	0	1	S13
0	1	1	1	0	S14
0	1	1	1	1	S15
1	X	X	X	X	All Outputs = 0, CD4514B All Outputs = 1, CD4515B

X = Don't Care Logic 1 = high Logic 0 = low

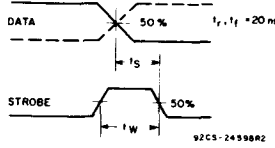
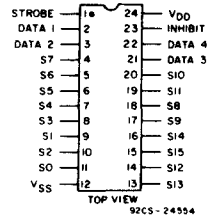
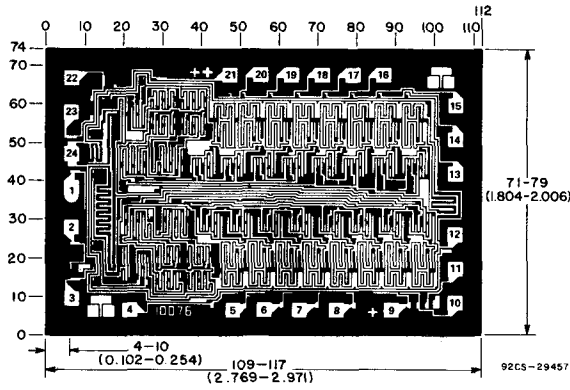

Fig. 14 - Waveforms for setup time and strobe pulse width.



CD4514B  
CD4515B

TERMINAL ASSIGNMENT



Dimensions and Pad Layout for CD4515B Chip  
(Dimensions and pad layout for the CD4514B are identical)

Dimensions in parentheses are in millimeters and are derived from the basic inch dimensions as indicated. Grid graduations are in mils ( $10^{-3}$  inch).

The photographs and dimensions of each CMOS chip represent a chip when it is part of the wafer. When the wafer is separated into individual chips, the angle of cleavage may vary with respect to the chip face for different chips. The actual dimensions of the isolated chip, therefore, may differ slightly from the nominal dimensions shown. The user should consider a tolerance of  $-3$  mils to  $+16$  mils applicable to the nominal dimensions shown.

# CMOS Dual 64-Stage Static Shift Register

High-Voltage Types (20-Volt Rating)

The RCA-CD4517B dual 64-stage static shift register consists of two independent registers each having a clock, data, and write enable input and outputs accessible at taps following the 16th, 32nd, 48th, and 64th stages. These taps also serve as input points allowing data to be inputted at the 17th, 33rd, and 49th stages when the write enable input is a logic 1 and the clock goes through a low-to-high transition. The truth table indicates how the clock and write enable inputs control the operation of the CD4517B. Inputs at the intermediate taps allow entry of 64 bits into the register with 16 clock pulses. The 3-state outputs permit connection of this device to an external bus.

The CD4517B is supplied in 16-lead hermetic dual-in-line ceramic packages (D and F suffixes), 16-lead dual-in-line plastic packages (E suffix), 16-lead ceramic flat packages (K suffix), and in chip form (H suffix).

**Features:**

- Low quiescent current – 10 nA/pkg (typ.) at  $V_{DD} = 5V$
- Clock frequency 12 MHz (typ.) at  $V_{DD} = 10V$
- Schmitt trigger clock inputs allow operation with very slow clock rise and fall times
- Capable of driving two low-power TTL loads, one low-power Schottky TTL load, or two HTL loads
- Three-state outputs
- 100% tested for quiescent current at 20 V
- Standardized, symmetrical output characteristics
- 5-V, 10-V and 15-V parametric ratings
- Meets all requirements of JEDEC Tentative Standard No.13A, "Standard Specifications for Description of 'B' Series CMOS Devices"

**Applications:**

- Time-delay circuits
- Scratch-pad memories
- General-purpose serial shift-register applications

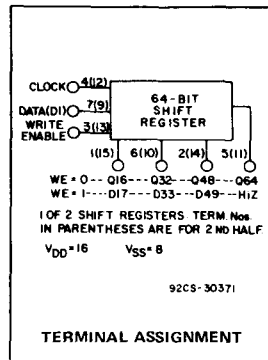
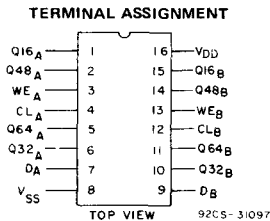

**MAXIMUM RATINGS, Absolute-Maximum Values:**

DC SUPPLY-VOLTAGE RANGE, ( $V_{DD}$ ) (Voltages referenced to $V_{SS}$ Terminal)	-0.5 to +20 V
INPUT VOLTAGE RANGE, ALL INPUTS	-0.5 to $V_{DD} + 0.5 V$
DC INPUT CURRENT, ANY ONE INPUT	$\pm 10$ mA
POWER DISSIPATION PER PACKAGE ( $P_D$ ):	
For $T_A = -40$ to $+60^\circ C$ (PACKAGE TYPE E)	500 mW
For $T_A = +60$ to $+85^\circ C$ (PACKAGE TYPE E)	Derate Linearly at 12 mW/ $^\circ C$ to 200 mW
For $T_A = -55$ to $+100^\circ C$ (PACKAGE TYPES D, F, K)	500 mW
For $T_A = +100$ to $+125^\circ C$ (PACKAGE TYPES D, F, K)	Derate Linearly at 12 mW/ $^\circ C$ to 200 mW
DEVICE DISSIPATION PER OUTPUT TRANSISTOR	
FOR $T_A =$ FULL PACKAGE-TEMPERATURE RANGE (All Package Types)	100 mW
OPERATING-TEMPERATURE RANGE ( $T_A$ ):	
PACKAGE TYPES D, F, K, H	-55 to $+125^\circ C$
PACKAGE TYPE E	-40 to $+85^\circ C$
STORAGE TEMPERATURE RANGE ( $T_{stg}$ )	-65 to $+150^\circ C$
LEAD TEMPERATURE (DURING SOLDERING):	
At distance 1/16 $\pm$ 1/32 inch (1.59 $\pm$ 0.79 mm) from case for 10 s max.	$+265^\circ C$

**RECOMMENDED OPERATING CONDITIONS**

For maximum reliability, nominal operating conditions should be selected so that operation is always within the following ranges:

CHARACTERISTIC	LIMITS		UNITS
	MIN.	MAX.	
Supply-Voltage Range (For $T_A =$ Full Package Temperature Range)	3	18	V

**TRUTH TABLE**

Clock	Write Enable	Data	Stage 16 Tap	Stage 32 Tap	Stage 48 Tap	Stage 64 Tap
0	0	X	Q16	Q32	Q48	Q64
0	1	X	Z	Z	Z	Z
1	0	X	Q16	Q32	Q48	Q64
1	1	X	Z	Z	Z	Z
	0	DI In	Q16	Q32	Q48	Q64
	1	DI In	D17 In	D33 In	D49 In	Z
	0	X	Q16	Q32	Q48	Q64
	1	X	Z	Z	Z	Z

X = Don't Care                      Z = High Impedance

# CD4517B Types

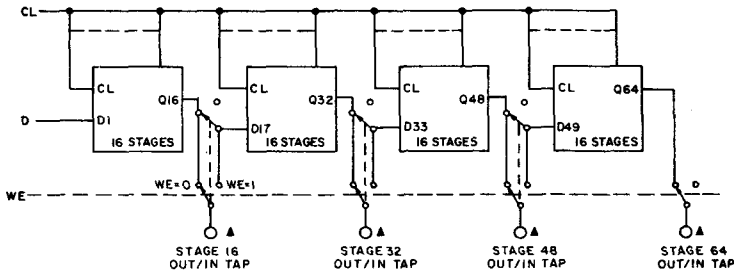

Fig. 1—CD4517B functional block diagram (one half).

92CM-31098R1

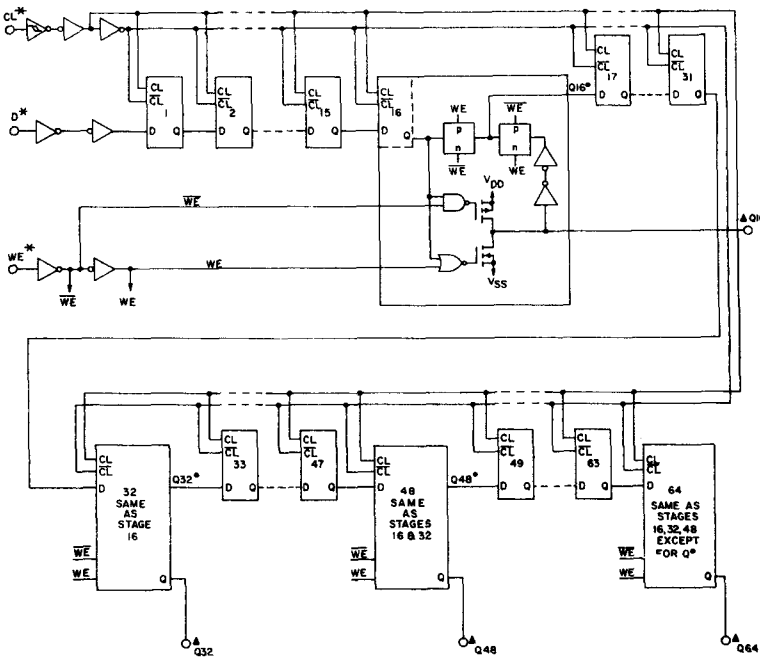

Fig. 2—CD4517B logic block diagram (one half).

92CL-32765

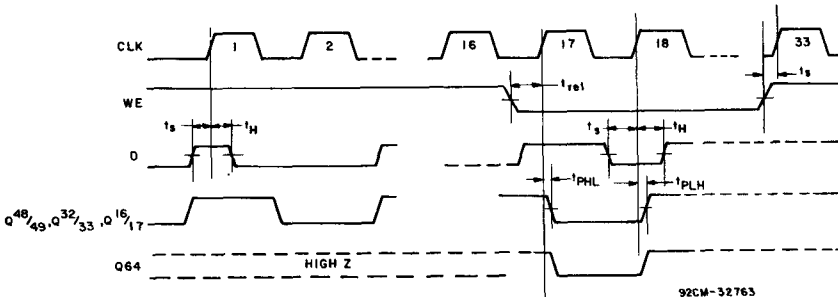

Fig. 3—Dynamic test waveforms.

92CM-32765

## STATIC ELECTRICAL CHARACTERISTICS

CHARACTERISTIC	CONDITIONS			LIMITS AT INDICATED TEMPERATURES (°C)							UNITS
	V <sub>O</sub> (V)	V <sub>IN</sub> (V)	V <sub>DD</sub> (V)	Values at -55, +25, +125 Apply to D, F, K, H Packages				Values at -40, +25, +85 Apply to E Package			
				-55	-40	+85	+125	+25			
								Min.	Typ.	Max.	
Quiescent Device Current, I <sub>DD</sub> Max.	-	0,5	5	5	5	150	150	-	0.04	5	μA
	-	0,10	10	10	10	300	300	-	0.04	10	
	-	0,15	15	20	20	600	600	-	0.04	20	
	-	0,20	20	100	100	3000	3000	-	0.08	100	
Output Low (Sink) Current, I <sub>OL</sub> Min.	0.4	0,5	5	0.64	0.61	0.42	0.36	0.51	1	-	mA
	0.5	0,10	10	1.6	1.5	1.1	0.9	1.3	2.6	-	
	1.5	0,15	15	4.2	4	2.8	2.4	3.4	6.8	-	
Output High (Source) Current, I <sub>OH</sub> Min.	4.6	0,5	5	-0.64	-0.61	-0.42	-0.36	-0.51	-1	-	mA
	2.5	0,5	5	-2	-1.8	-1.3	-1.15	-1.6	-3.2	-	
	9.5	0,10	10	-1.6	-1.5	-1.1	-0.9	-1.3	-2.6	-	
	13.5	0,15	15	-4.2	-4	-2.8	-2.4	-3.4	-6.8	-	
Output Voltage: Low-Level, V <sub>OL</sub> Max.	-	0,5	5			0.05			0	0.05	V
	-	0,10	10			0.05			0	0.05	
	-	0,15	15			0.05			0	0.05	
Output Voltage: High-Level, V <sub>OH</sub> Min.	-	0,5	5			4.95			4.95	5	V
	-	0,10	10			9.95			9.95	10	
	-	0,15	15			14.95			14.95	15	
Input Low Voltage, V <sub>IL</sub> Max.	0.5, 4.5	-	5			1.5			-	1.5	V
	1.9	-	10			3			-	3	
	1.5, 13.5	-	15			4			-	4	
Input High Voltage, V <sub>IH</sub> Min.	0.5, 4.5	-	5			3.5			3.5	-	V
	1.9	-	10			7			7	-	
	1.5, 13.5	-	15			11			11	-	
Input Current, I <sub>IN</sub> Max.	-	0,18	18	±0.1	±0.1	±1	±1	-	±10 <sup>-5</sup>	±0.1	μA
3-State Output Leakage Current, I <sub>OUT</sub> Max.	0,18	0,18	18	±0.4	±0.4	±12	±12	-	±10 <sup>-4</sup>	±0.4	μA

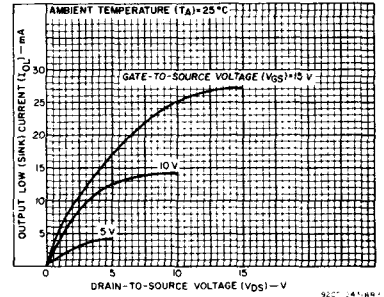

Fig. 4—Typical n-channel output low (sink) current characteristics.

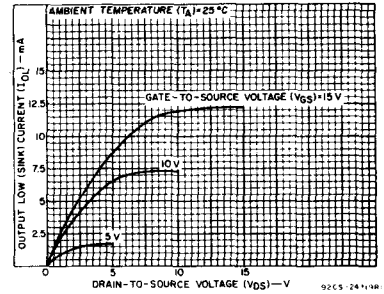

Fig. 5—Minimum n-channel output low (sink) current characteristics.

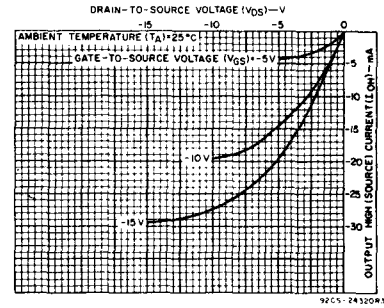

Fig. 6—Typical p-channel output high (source) current characteristics.

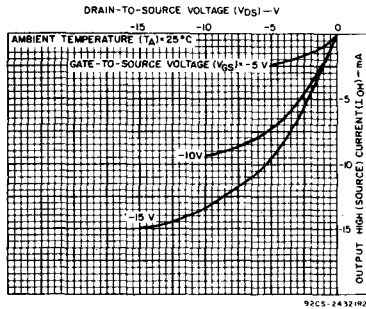

Fig. 7—Minimum p-channel output high (source) current characteristics.

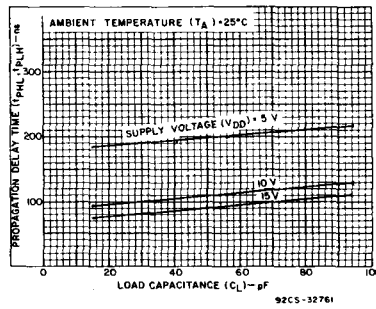

Fig. 8—Typical propagation delay time as a function of load capacitance.

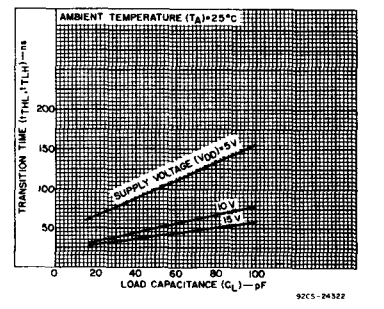

Fig. 9—Typical transition time as a function of load capacitance.

# CD4517B Types

**DYNAMIC ELECTRICAL CHARACTERISTICS** at  $T_A = 25^\circ\text{C}$ ; Input  $t_r, t_f = 20\text{ ns}$ ,  
 $C_L = 50\text{ pF}$ ,  $R_L = 200\text{ k}\Omega$

CHARACTERISTIC	TEST CONDITIONS	$V_{DD}$ (V)	LIMITS			UNITS
			Min.	Typ.	Max.	
Propagation Delay Time: CL to Bit 16 Tap $t_{PHL}, t_{PLH}$		5	—	200	400	ns
		10	—	110	220	
		15	—	90	180	
3-State Output, WE to Bit 16 Tap $t_{PHZ}, t_{PLZ}; t_{PZH}, t_{PZL}$ (See Note)		5	—	75	150	ns
		10	—	40	80	
		15	—	30	60	
Output Transition Time $t_{THL}, t_{TLH}$		5	—	100	200	ns
		10	—	50	100	
		15	—	40	80	
Write Enable-to-Clock Setup Time		5	0	-50	—	ns
		10	0	-25	—	
		15	0	-15	—	
Data-to-Clock Setup Time, $t_s$		5	20	0	—	ns
		10	10	0	—	
		15	10	0	—	
Minimum Write Enable-to-Clock Release Time		5	—	50	100	ns
		10	—	25	50	
		15	—	20	40	
Minimum Data-to-Clock Hold Time, $t_H$		5	—	100	200	ns
		10	—	50	100	
		15	—	25	50	
Minimum Clock Pulse Width, $t_W$		5	—	90	180	ns
		10	—	40	80	
		15	—	25	50	
Maximum Clock Input Frequency, $f_{CL}$		5	3	6	—	MHz
		10	6	12	—	
		15	8	15	—	
Maximum Clock Input Rise or Fall Time, $t_{rCL}, t_{fCL}$		5	UNLIMITED			$\mu\text{s}$
		10	UNLIMITED			
		15	UNLIMITED			
Input Capacitance $C_{IN}$	Any Input		—	5	7.5	$\text{pF}$

**NOTE:** Measured at the point of 10% change in output with an output load of 50 pF,  $R_L = 1\text{ k}\Omega$  to  $V_{DD}$  for  $t_{PZL}, t_{PLZ}$  and  $R_L = 1\text{ k}\Omega$  to  $V_{SS}$  for  $t_{PZH}, t_{PHZ}$ .

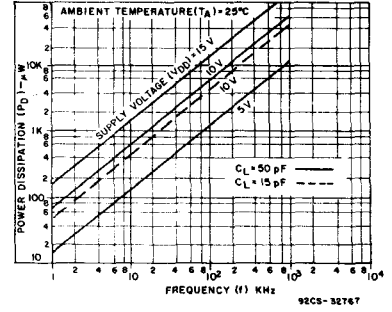

Fig. 10—Typical power dissipation as a function of frequency.

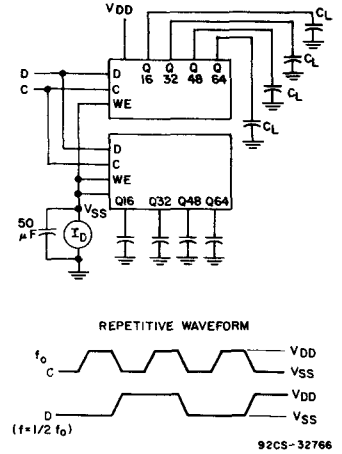

Fig. 11—Dynamic power dissipation test circuit and waveforms.

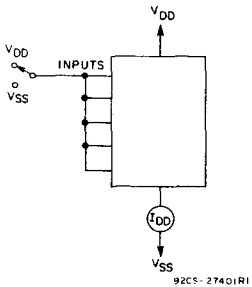

Fig. 12—Quiescent device current test circuit.

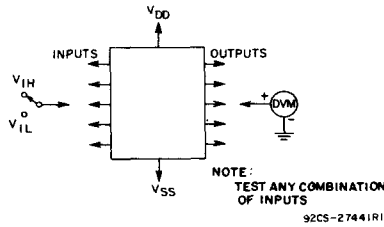

Fig. 13—Input voltage test circuit.

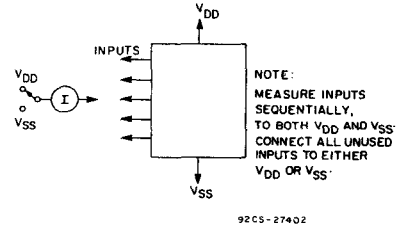
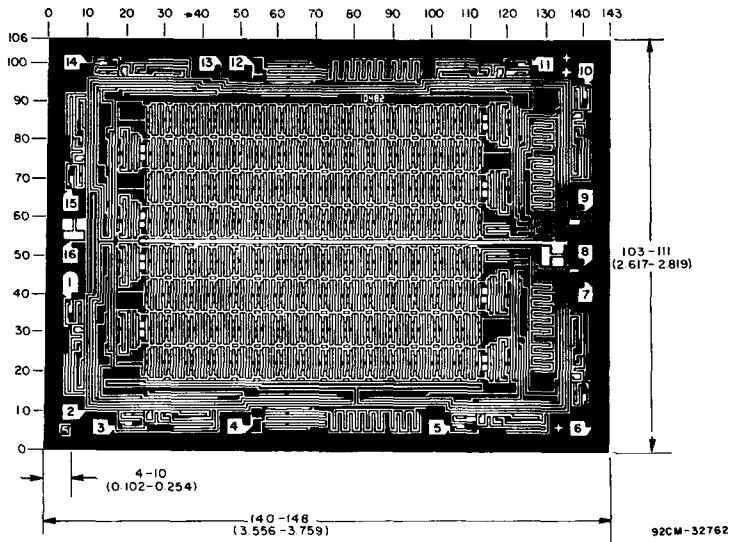

Fig. 14—Input current test circuit.



## CD4517B Types



**Dimensions and pad layout for CD4517B.**

*Dimensions in parentheses are in millimeters and are derived from the basic inch dimensions as indicated. Grid graduations are in mils ( $10^{-3}$  inch).*

*The photographs and dimensions of each CMOS chip represent a chip when it is part of the wafer. When the wafer is separated into individual chips, the angle of cleavage may vary with respect to the chip face for different chips. The actual dimensions of the isolated chip, therefore, may differ slightly from the nominal dimensions shown. The user should consider a tolerance of  $-3$  mils to  $+16$  mils applicable to the nominal dimensions shown.*

# CD4518B, CD4520B Types

## CMOS Dual Up-Counters

High-Voltage Types (20-Volt Rating)

CD4518B Dual BCD Up-Counter  
CD4520B Dual Binary Up-Counter

The RCA-CD4518 Dual BCD Up-Counter and CD4520 Dual Binary Up-Counter each consist of two identical, internally synchronous 4-stage counters. The counter stages are D-type flip-flops having interchangeable CLOCK and ENABLE lines for incrementing on either the positive-going or negative-going transition. For single-unit operation the ENABLE input is maintained high and the counter advances on each positive-going transition of the CLOCK. The counters are cleared by high levels on their RESET lines.

The counter can be cascaded in the ripple mode by connecting Q4 to the enable input of the subsequent counter while the CLOCK input of the latter is held low.

The CD4518B and CD4520B types are supplied in 16-lead hermetic dual-in-line ceramic packages (D and F suffixes), 16-lead dual-in-line plastic packages (E suffix), 16-lead ceramic flat packages (K suffix), and in chip form (H suffix).

### MAXIMUM RATINGS, Absolute-Maximum Values:

DC SUPPLY-VOLTAGE RANGE, (V <sub>DD</sub> ) (Voltages referenced to V <sub>SS</sub> Terminal)	-0.5 to +20 V
INPUT VOLTAGE RANGE, ALL INPUTS	-0.5 to V <sub>DD</sub> +0.5 V
DC INPUT CURRENT, ANY ONE INPUT	±10 mA
POWER DISSIPATION PER PACKAGE (P <sub>D</sub> ):	
For T <sub>A</sub> = -40 to +60°C (PACKAGE TYPE E)	500 mW
For T <sub>A</sub> = +60 to +85°C (PACKAGE TYPE E)	Derate Linearly at 12 mW/°C to 200 mW
For T <sub>A</sub> = -55 to +100°C (PACKAGE TYPES D, F, K)	500 mW
For T <sub>A</sub> = +100 to +125°C (PACKAGE TYPES D, F, K)	Derate Linearly at 12 mW/°C to 200 mW
DEVICE DISSIPATION PER OUTPUT TRANSISTOR FOR T <sub>A</sub> = FULL PACKAGE-TEMPERATURE RANGE (All Package Types)	100 mW
OPERATING-TEMPERATURE RANGE (T <sub>A</sub> ):	
PACKAGE TYPES D, F, K, H	-55 to +125°C
PACKAGE TYPE E	-40 to +85°C
STORAGE TEMPERATURE RANGE (T <sub>stg</sub> )	-65 to +150°C
LEAD TEMPERATURE (DURING SOLDERING): At distance 1/16 ± 1/32 inch (1.59 ± 0.79 mm) from case for 10 s max.	+265°C

### Features:

- Medium-speed operation — 6-MHz typical clock frequency at 10 V
- Positive- or negative-edge triggering
- Synchronous internal carry propagation
- 100% tested for quiescent current at 20 V
- Maximum input current of 1 μA at 18 V over full package-temperature range; 100 nA at 18 V and 25°C
- Noise margin (over full package-temperature range): 1 V at V<sub>DD</sub> = 5 V, 2 V at V<sub>DD</sub> = 10 V, 2.5 V at V<sub>DD</sub> = 15 V
- 5-V, 10-V, and 15-V parametric ratings
- Standardized, symmetrical output characteristics
- Meets all requirements of JEDEC Tentative Standard No. 13A, "Standard Specifications for Description of 'B' Series CMOS Devices"

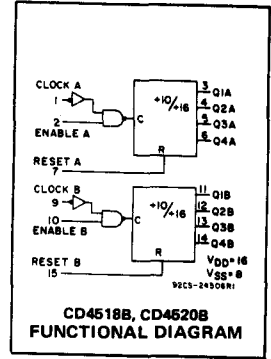

### Applications:

- Multistage synchronous counting
- Multistage ripple counting
- Frequency dividers

### TRUTH TABLE

CLOCK	ENABLE	RESET	ACTION
	1	0	Increment Counter
0		0	Increment Counter
	X	0	No Change
X		0	No Change
	0	0	No Change
1		0	No Change
X	X	1	Q1 thru Q4 = 0

X = Don't Care    1 ≡ High State    0 ≡ Low State

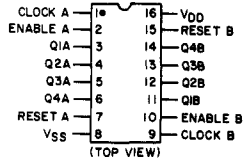

### CD4518B, CD4520B TERMINAL ASSIGNMENT

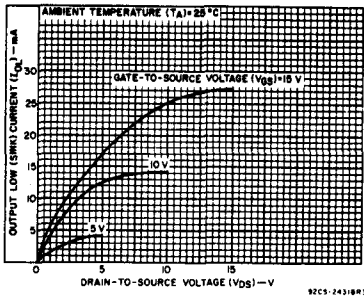

Fig. 1 - Typical output low (sink) current characteristics.

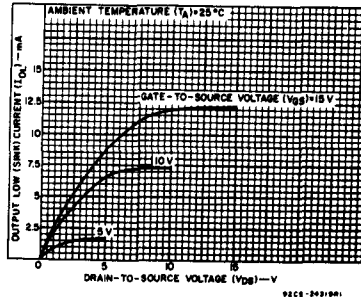

Fig. 2 - Minimum output low (sink) current characteristics.

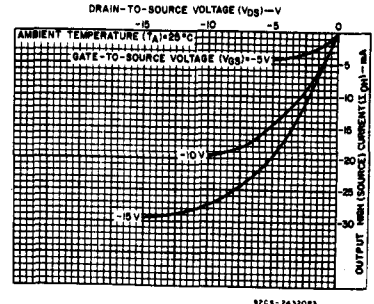

Fig. 3 - Typical output high (source) current characteristics.

# CD4518B, CD4520B Types

## STATIC ELECTRICAL CHARACTERISTICS

CHARACTERISTIC	CONDITIONS			LIMITS AT INDICATED TEMPERATURES (°C)							UNITS
	V <sub>O</sub> (V)	V <sub>IN</sub> (V)	V <sub>DD</sub> (V)	-55				+25			
				-40	+85	+125	Min.	Typ.	Max.		
Quiescent Device Current, I <sub>DD</sub> Max.	-	0,5	5	5	5	150	150	-	0.04	5	μA
	-	0,10	10	10	10	300	300	-	0.04	10	
	-	0,15	15	20	20	600	600	-	0.04	20	
	-	0,20	20	100	100	3000	3000	-	0.08	100	
Output Low (Sink) Current I <sub>OL</sub> Min.	0.4	0,5	5	0.64	0.61	0.42	0.36	0.51	1	-	mA
	0.5	0,10	10	1.6	1.5	1.1	0.9	1.3	2.6	-	
	1.5	0,15	15	4.2	4	2.8	2.4	3.4	6.8	-	
Output High (Source) Current, I <sub>OH</sub> Min.	4.6	0,5	5	-0.64	-0.61	-0.42	-0.36	-0.51	-1	-	mA
	2.5	0,5	5	-2	-1.8	-1.3	-1.15	-1.6	-3.2	-	
	9.5	0,10	10	-1.6	-1.5	-1.1	-0.9	-1.3	-2.6	-	
	13.5	0,15	15	-4.2	-4	-2.8	-2.4	-3.4	-6.8	-	
Output Voltage: Low-Level, V <sub>OL</sub> Max.	-	0,5	5	0.05				-	0	0.05	V
	-	0,10	10	0.05				-	0	0.05	
	-	0,15	15	0.05				-	0	0.05	
Output Voltage: High-Level, V <sub>OH</sub> Min.	-	0,5	5	4.95				4.95	5	-	V
	-	0,10	10	9.95				9.95	10	-	
	-	0,15	15	14.95				14.95	15	-	
Input Low Voltage, V <sub>IL</sub> Max.	0.5, 4.5	-	5	1.5				-	-	1.5	V
	1, 9	-	10	3				-	-	3	
	1.5, 13.5	-	15	4				-	-	4	
Input High Voltage, V <sub>IH</sub> Min.	0.5, 4.5	-	5	3.5				3.5	-	-	V
	1, 9	-	10	7				7	-	-	
	1.5, 13.5	-	15	11				11	-	-	
Input Current I <sub>IN</sub> Max.	-	0,18	18	±0.1	±0.1	±1	±1	-	±10 <sup>-5</sup>	±0.1	μA

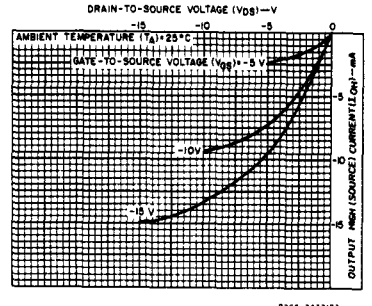

Fig. 4 - Minimum output high (source) current characteristics.

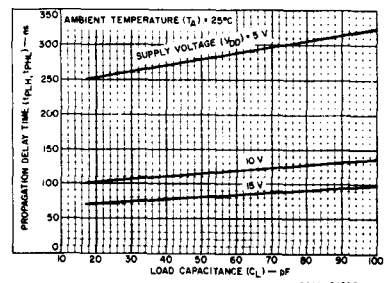

Fig. 5 - Typical propagation delay vs. load capacitance, clock or enable to output.

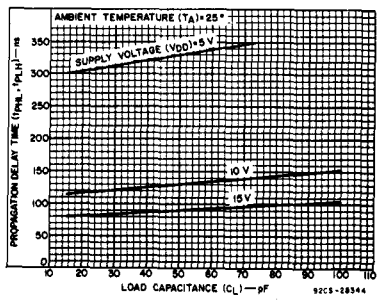

Fig. 6 - Typical propagation delay time vs. load capacitance, reset to output.

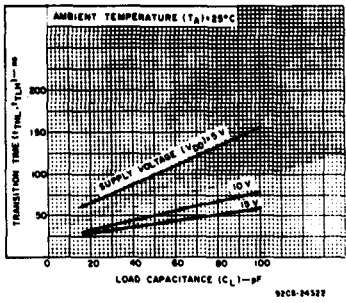

Fig. 7 - Typical transition time vs. load capacitance.

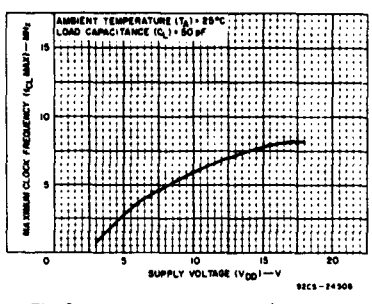

Fig. 8 - Typical maximum-clock-frequency vs. supply voltage.

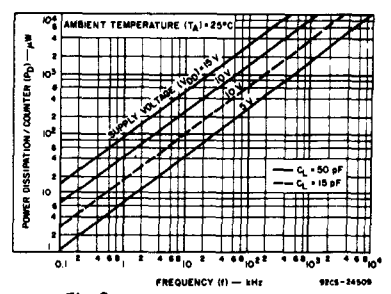

Fig. 9 - Typical power dissipation characteristics.

# CD4518B, CD4520B Types

RECOMMENDED OPERATING CONDITIONS at  $T_A = 25^\circ\text{C}$ , Except as Noted.  
For maximum reliability, nominal operating conditions should be selected so that operation is always within the following ranges:

CHARACTERISTIC	$V_{DD}$ (V)	LIMITS		UNITS
		Min.	Max.	
Supply Voltage Range (For $T_A$ = Full Package Temperature Range)		3	18	V
Enable Pulse Width, $t_W$	5	400	—	ns
	10	200	—	
	15	140	—	
Clock Pulse Width, $t_W$	5	200	—	ns
	10	100	—	
	15	70	—	
Clock Input Frequency, $f_{CL}$	5	—	1.5	MHz
	10	dc	3	
	15	—	4	
Clock Rise or Fall Time, $t_{rCL}$ or $t_{fCL}$ :	5	—	15	$\mu\text{s}$
	10	—	5	
	15	—	5	
Reset Pulse Width, $t_W$	5	250	—	ns
	10	110	—	
	15	80	—	

## DYNAMIC ELECTRICAL CHARACTERISTICS at $T_A = 25^\circ\text{C}$ ; Input $t_r, t_f = 20 \text{ ns}$ , $C_L = 50 \text{ pF}$ , $R_L = 200 \text{ K}\Omega$

CHARACTERISTIC	TEST CONDITIONS	LIMITS			UNITS	
		$V_{DD}$ V	Min.	Typ.		Max.
Propagation Delay Time, $t_{PHL}$ , $t_{PLH}$ : Clock or Enable to Output		5	—	280	560	ns
		10	—	115	230	
		15	—	80	160	
Reset to Output		5	—	330	650	ns
		10	—	130	225	
		15	—	90	170	
Transition Time, $t_{THL}$ , $t_{TLH}$		5	—	100	200	ns
		10	—	50	100	
		15	—	40	80	
Maximum Clock Input Frequency, $f_{CL}$		5	1.5	3	—	MHz
		10	3	6	—	
		15	4	8	—	
Minimum Clock Pulse Width, $t_W$		5	—	100	200	ns
		10	—	50	100	
		15	—	35	70	
Clock Rise or Fall Time, $t_r$ or $t_f$ :		5	—	—	15	$\mu\text{s}$
		10, 15	—	—	5	
Minimum Reset Pulse Width, $t_W$		5	—	125	250	ns
		10	—	55	110	
		15	—	40	80	
Minimum Enable Pulse Width, $t_W$		5	—	200	400	ns
		10	—	100	200	
		15	—	70	140	
Input Capacitance, $C_{iN}$	Any Input		—	5	7.5	pF

## TEST CIRCUITS

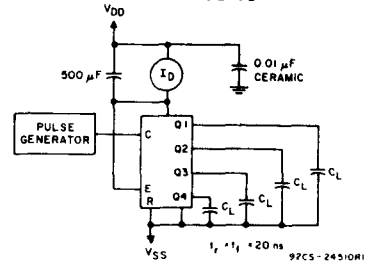

Fig. 10 - Dynamic power dissipation.

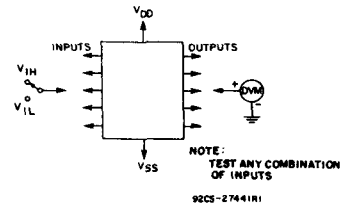

Fig. 11 - Input voltage.

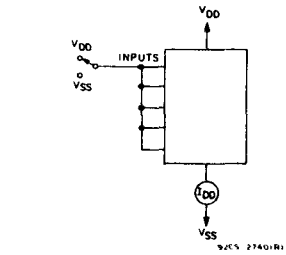

Fig. 12 - Quiescent device current test circuit.

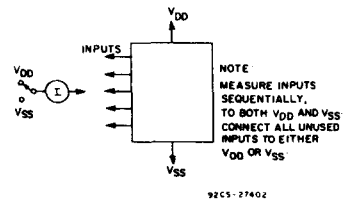

Fig. 13 - Input leakage current test circuit.

# CD4518B, CD4520B Types

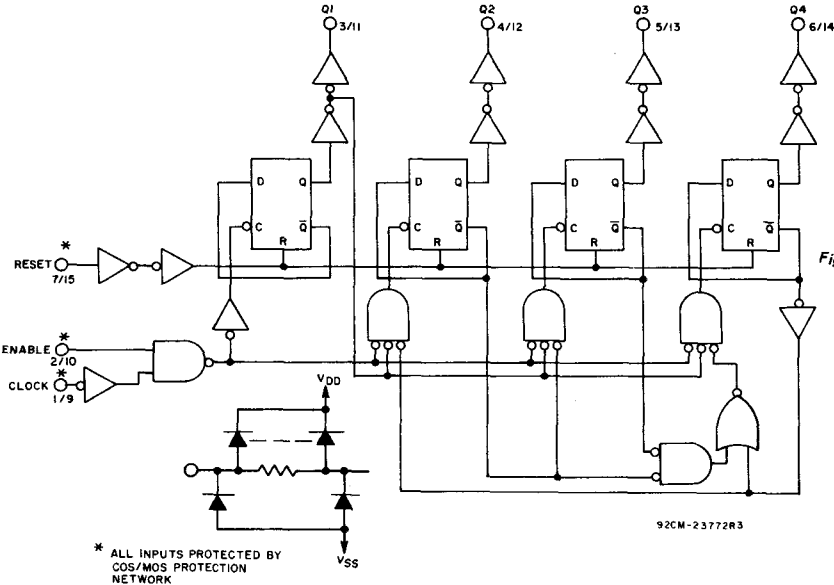

Fig. 14 — Decade counter (CD4518B) logic diagram for one of two identical counters.

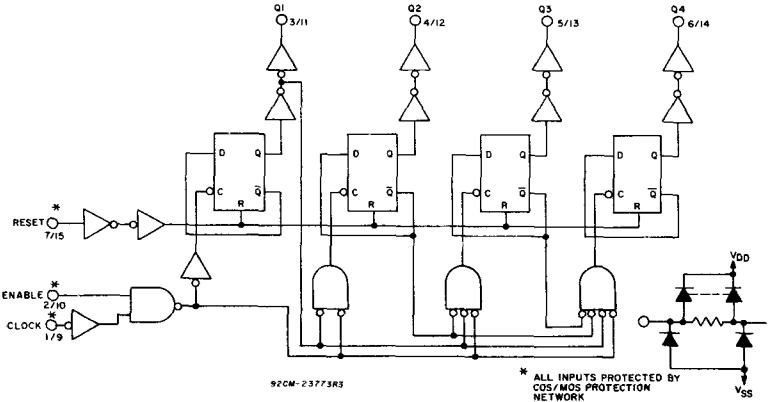

Fig. 15 — Binary counter (CD4520B) logic diagram for one of two identical counters.

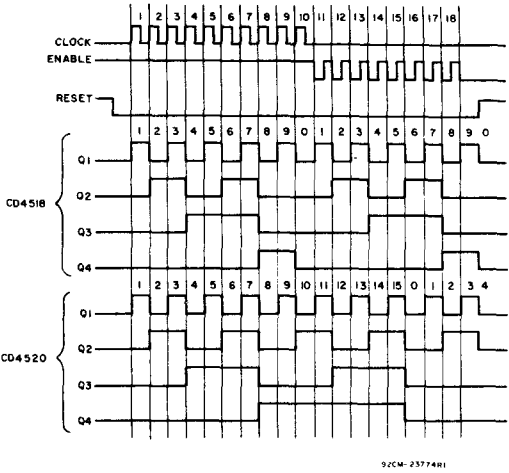

Fig. 16 — Timing diagrams for CD4518B and CD4520B.

92CM-23774R1

# CD4518B, CD4520B Types

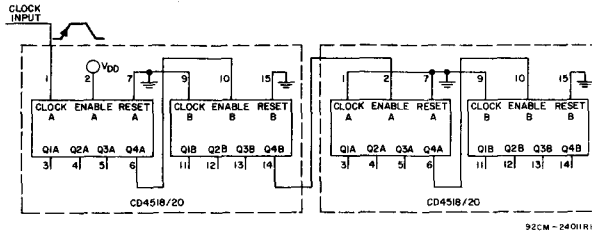
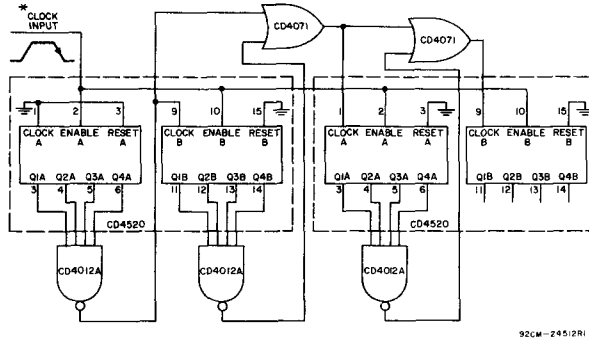
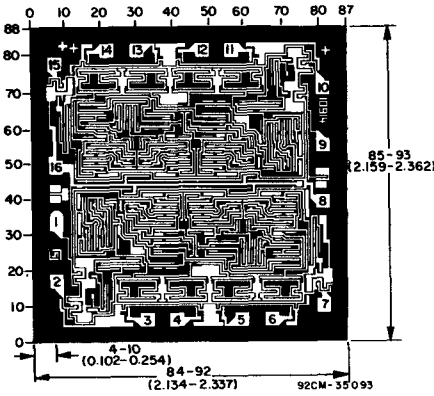

Fig. 17 - Ripple cascading of four counters with positive edge triggering.



\*NOTE:  
FOR SYNCHRONOUS CASCADING, THE CLOCK TRANSITION TIME SHOULD BE MADE LESS THAN OR EQUAL TO THE SUM OF THE FIXED PROPAGATION DELAY AT 15 pF AND THE TRANSITION TIME OF THE OUTPUT DRIVER STAGE FOR THE ESTIMATED CAPACITATIVE LOAD.

Fig. 18 - Synchronous cascading of four binary counters with negative edge triggering.



Dimensions and pad layout for CD4518BH chip.

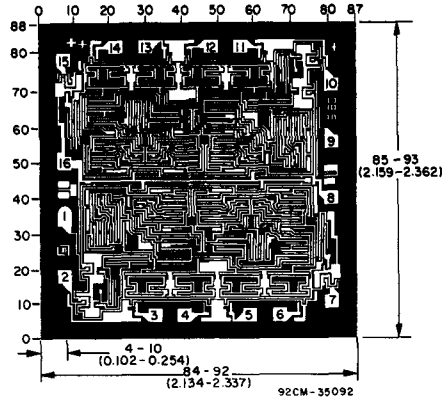

Dimensions and pad layout for CD4520BH chip.

Dimensions in parentheses are in millimeters and are derived from the basic inch dimensions as indicated. Grid graduations are in mils ( $10^{-3}$  inch).

The photographs and dimensions of each CMOS chip represent a chip when it is part of the wafer. When the wafer is separated into individual chips, the angle of cleavage may vary with respect to the chip face for different chips. The actual dimensions of the isolated chip, therefore, may differ slightly from the nominal dimensions shown. The user should consider a tolerance of  $\pm 3$  mils applicable to the nominal dimensions shown.

# CMOS BCD Rate Multiplier

High-Voltage Types (20-Volt Rating)

The RCA-CD4527B is a low-power 4-bit digital rate multiplier that provides an output-pulse rate which is the clock-input-pulse rate multiplied by 1/10 times the BCD input. For example, when the BCD input is 8, there will be 8 output pulses for every 10 input pulses. This device may be used to perform arithmetic operations (add, subtract, divide, raise to a power), solve algebraic and differential equations, generate natural logarithms and trigonometric functions, A/D and D/A conversion, and frequency division.

For fractional multipliers with more than one digit, CD4527B devices may be cascaded in two different modes: the Add mode and the Multiply mode. (See Figs.12 and 15). In the Add mode,

$$\text{Output Rate} = (\text{Clock Rate}) \left[ \begin{matrix} 0.1 \text{ BCD}_1 + 0.01 \text{ BCD}_2 + \\ 0.001 \text{ BCD}_3 + \dots \end{matrix} \right]$$

In the Multiply mode, the fraction programmed into the first rate multiplier is multiplied by the fraction programmed into the second one,

$$\text{e.g. } \frac{9}{10} \times \frac{4}{10} = \frac{36}{100} \text{ or } 36 \text{ output}$$

pulses for every 100 clock input pulses.

The CD4527B types are supplied in 16-lead ceramic dual-in-line packages (D and F suffixes), 16-lead dual-in-line plastic packages (E suffix), 16-lead ceramic flat packages (K suffix), and in chip form (H suffix).

### Applications:

- Numerical control
- Instrumentation
- Digital filtering
- Frequency synthesis

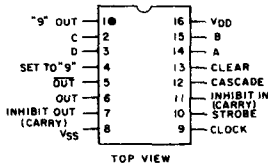

TERMINAL ASSIGNMENT

### Features:

- Cascadable in multiples of 4-bits
- Set to "9" input and "9" detect output
- 100% test for quiescent current at 20 V
- 5-V, 10-V, and 15-V parametric ratings
- Standardized, symmetrical output characteristics
- Maximum input current of 1  $\mu$ A at 18 V over full package-temperature range; 100 nA at 18 V and 25°C
- Noise margin (full package-temperature range) =
  - 1 V at V<sub>DD</sub> = 5 V
  - 2 V at V<sub>DD</sub> = 10 V
  - 2.5 V at V<sub>DD</sub> = 15 V
- Meets all requirements of JEDEC Tentative Standard No. 13A, "Standard Specifications for Description of 'B' Series CMOS Devices"

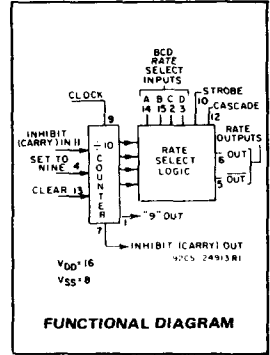

### MAXIMUM RATINGS, Absolute-Maximum Values:

DC SUPPLY-VOLTAGE RANGE, (V <sub>DD</sub> ) (Voltages referenced to V <sub>SS</sub> Terminal)	-0.5 to +20 V
INPUT VOLTAGE RANGE, ALL INPUTS	-0.5 to V <sub>DD</sub> +0.5 V
DC INPUT CURRENT, ANY ONE INPUT	±10 mA
POWER DISSIPATION PER PACKAGE (P <sub>D</sub> ):	
For T <sub>A</sub> = -40 to +60°C (PACKAGE TYPE E)	500 mW
For T <sub>A</sub> = +60 to +85°C (PACKAGE TYPE E)	Derate Linearly at 12 mW/°C to 200 mW
For T <sub>A</sub> = -55 to +100°C (PACKAGE TYPES D, F, K)	500 mW
For T <sub>A</sub> = +100 to +125°C (PACKAGE TYPES D, F, K)	Derate Linearly at 12 mW/°C to 200 mW
DEVICE DISSIPATION PER OUTPUT TRANSISTOR FOR T <sub>A</sub> = FULL PACKAGE-TEMPERATURE RANGE (All Package Types)	100 mW
OPERATING-TEMPERATURE RANGE (T <sub>A</sub> ):	
PACKAGE TYPES D, F, K, H	-55 to +125°C
PACKAGE TYPE E	-40 to +85°C
STORAGE TEMPERATURE RANGE (T <sub>stg</sub> )	-65 to +150°C
LEAD TEMPERATURE (DURING SOLDERING):	
At distance 1/16 ± 1/32 inch (1.59 ± 0.79 mm) from case for 10 s max.	+265°C

### RECOMMENDED OPERATING CONDITIONS AT T<sub>A</sub> = 25°C, Except as Noted.

For maximum reliability, nominal operating conditions should be selected so that operation is always within the following ranges:

CHARACTERISTIC	V <sub>DD</sub> (V)	LIMITS		UNITS
		Min.	Max.	
Supply-Voltage Range (For T <sub>A</sub> = Full Package-Temperature Range)		3	18	V
Set or Clear Pulse Width, t <sub>W</sub>	5	160	—	ns
	10	90	—	
	15	60	—	
Clock Pulse Width, t <sub>W</sub>	5	330	—	ns
	10	170	—	
	15	100	—	
Clock Frequency, f <sub>CL</sub>	5	—	1.2	MHz
	10	dc	2.5	
	15	—	3.5	
Clock Rise or Fall Time, t <sub>rCL</sub> or t <sub>fCL</sub>	5, 10, 15	—	15	μs
	5	100	—	
	10	40	—	
Inhibit In Setup Time, t <sub>SU</sub>	15	20	—	ns
	5	240	—	
	10	130	—	
Inhibit In Removal Time, t <sub>REM</sub>	15	110	—	ns
	5	150	—	
	10	80	—	
Set Removal Time, t <sub>REM</sub>	15	50	—	ns
	5	60	—	
	10	40	—	
Clear Removal Time, t <sub>REM</sub>	15	30	—	ns
	5	60	—	
	10	40	—	

# CD4527B Types

## STATIC ELECTRICAL CHARACTERISTICS

CHARACTERISTIC	CONDITIONS			LIMITS AT INDICATED TEMPERATURES (°C)							UNITS	
	V <sub>O</sub> (V)	V <sub>IN</sub> (V)	V <sub>DD</sub> (V)	Values at -55, +25, +125 Apply to D, F, K, H Packages Values at -40, +25, +85 Apply to E Package								
				-55	-40	+85	+125	+25		Max.		
Quiescent Device Current, I <sub>DD</sub> Max.	-	0,5	5	5	5	150	150	-	0.04	5	μA	
	-	0,10	10	10	10	300	300	-	0.04	10		
	-	0,15	15	20	20	600	600	-	0.04	20		
	-	0,20	20	100	100	3000	3000	-	0.08	100		
Output Low (Sink) Current I <sub>OL</sub> Min.	0.4	0,5	5	0.64	0.61	0.42	0.36	0.51	1	-	mA	
	0.5	0,10	10	1.6	1.5	1.1	0.9	1.3	2.6	-		
	1.5	0,15	15	4.2	4	2.8	2.4	3.4	6.8	-		
Output High (Source) Current, I <sub>OH</sub> Min.	4.6	0,5	5	-0.64	-0.61	-0.42	-0.36	-0.51	-1	-	mA	
	2.5	0,5	5	-2	-1.8	-1.3	-1.15	-1.6	-3.2	-		
	9.5	0,10	10	-1.6	-1.5	-1.1	-0.9	-1.3	-2.6	-		
	13.5	0,15	15	-4.2	-4	-2.8	-2.4	-3.4	-6.8	-		
Output Voltage: Low-Level, V <sub>OL</sub> Max.	-	0,5	5	0.05			-			0	0.05	V
	-	0,10	10	0.05			-			0	0.05	
	-	0,15	15	0.05			-			0	0.05	
Output Voltage: High-Level, V <sub>OH</sub> Min.	-	0,5	5	4.95			4.95			5	-	V
	-	0,10	10	9.95			9.95			10	-	
	-	0,15	15	14.95			14.95			15	-	
Input Low Voltage, V <sub>IL</sub> Max.	0.5, 4.5	-	5	1.5			-			1.5	V	
	1, 9	-	10	3			-			3		
Input High Voltage, V <sub>IH</sub> Min.	0.5, 4.5	-	5	3.5			3.5			-	-	
	1, 9	-	10	7			7			-	-	
Input Current I <sub>IN</sub> Max.	0.5, 4.5	-	5	11			11			-	-	
	1.5, 13.5	-	15	11			11			-	-	
Input Current I <sub>IN</sub> Max.		0,18	18	±0.1	±0.1	±1	±1	-	±10 <sup>-5</sup>	±0.1	μA	

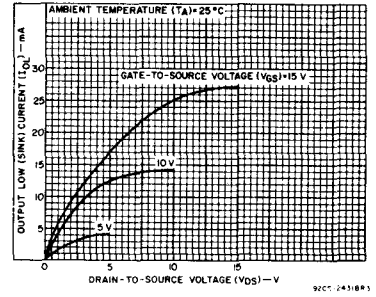

Fig. 1 - Typical output low (sink) current characteristics.

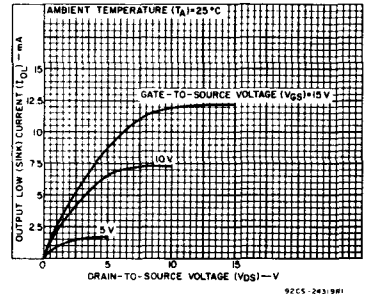

Fig. 2 - Minimum output low (sink) current characteristics.

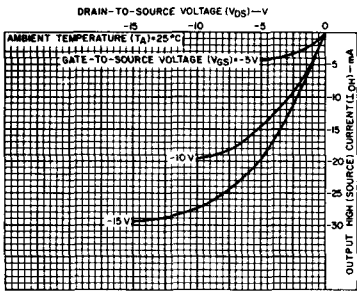

Fig. 3 - Typical output high (source) current characteristics.

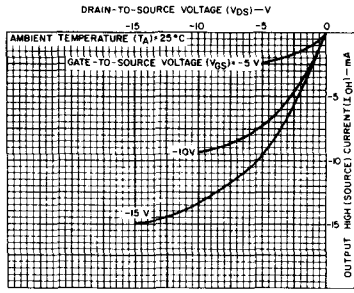

Fig. 4 - Minimum output high (source) current characteristics.

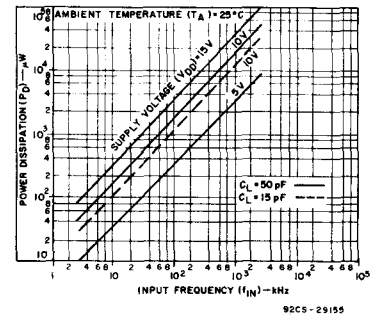

Fig. 5 - Typical dynamic power dissipation as a function of input frequency.

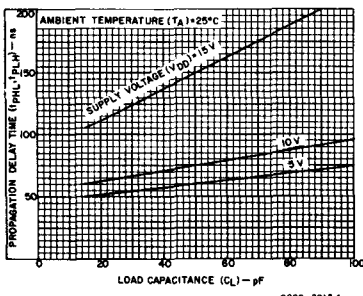

Fig. 6 - Typical propagation delay time as a function of load capacitance (Clock or Strobe to Out).

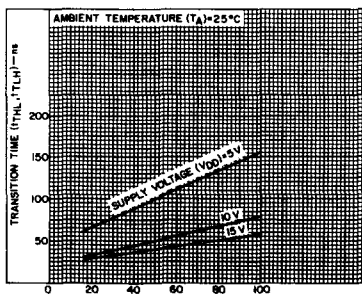

Fig. 7 - Typical transition time as a function of load capacitance.

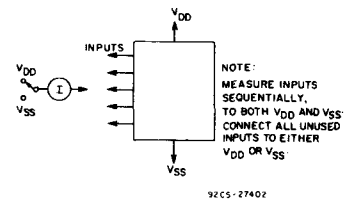

Fig. 8 - Input current test circuit.



# CD4527B Types

**DYNAMIC ELECTRICAL CHARACTERISTICS at  $T_A = 25^\circ\text{C}$ :**  
 Input  $t_r, t_f = 20 \text{ ns}$ ,  $C_L = 50 \text{ pF}$ ,  $R_L = 200 \text{ k}\Omega$

CHARACTERISTIC	TEST CONDITIONS	LIMITS			UNITS	
		VDD (V)	Min.	Typ.		Max.
Propagation Delay Time, $t_{PHL}$ , $t_{PLH}$ Clock to $\overline{\text{Out}}$		5	—	110	220	ns
		10	—	55	110	
		15	—	45	90	
Clock or Strobe to Out		5	—	150	300	ns
		10	—	75	150	
		15	—	60	120	
Clock to Inhibit Out High Level to Low Level		5	—	320	640	ns
		10	—	145	290	
		15	—	100	200	
Low Level to High Level		5	—	250	500	ns
		10	—	100	200	
		15	—	75	150	
Clear to Out		5	—	380	760	ns
		10	—	175	350	
		15	—	130	260	
Clock to "9" or "15" Out		5	—	300	600	ns
		10	—	125	250	
		15	—	90	180	
Cascade to Out		5	—	90	180	ns
		10	—	45	90	
		15	—	35	70	
Inhibit In to Inhibit Out		5	—	130	260	ns
		10	—	60	120	
		15	—	45	90	
Set to Out		5	—	330	660	ns
		10	—	150	300	
		15	—	110	220	
Transition Time, $t_{THL}$ , $t_{TLH}$		5	—	100	200	ns
		10	—	50	100	
		15	—	40	80	
Maximum Clock Frequency, $f_{CL}$		5	1.2	2.4	—	MHz
		10	2.5	5	—	
		15	3.5	7	—	
Minimum Clock Pulse Width, $t_W$		5	—	165	330	ns
		10	—	85	170	
		15	—	50	100	
Clock Rise or Fall Time, $t_{rCL}$ , $t_{fCL}$		5	—	—	15	$\mu\text{s}$
		10	—	—	15	
		15	—	—	15	
Minimum Set or Clear Pulse Width, $t_W$		5	—	80	160	ns
		10	—	45	90	
		15	—	30	60	
Minimum Inhibit In Setup Time, $t_{SU}$		5	—	50	100	ns
		10	—	20	40	
		15	—	10	20	
Minimum Inhibit In Removal Time, $t_{REM}$		5	—	120	240	ns
		10	—	65	130	
		15	—	55	110	
Minimum Set Removal Time, $t_{REM}$		5	—	75	150	ns
		10	—	40	80	
		15	—	25	50	
Minimum Clear Removal Time, $t_{REM}$		5	—	30	60	ns
		10	—	20	40	
		15	—	15	30	
Input Capacitance, $C_{IN}$	Any Input		—	5	7.5	pF

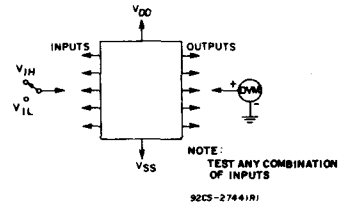

Fig. 9 - Input voltage test circuit.

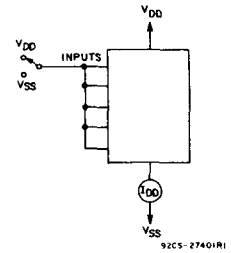

Fig. 10 - Quiescent device current test circuit.

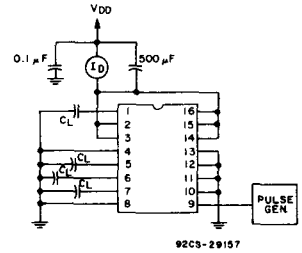

Fig. 11 - Dynamic power dissipation test circuit.

## APPLICATIONS

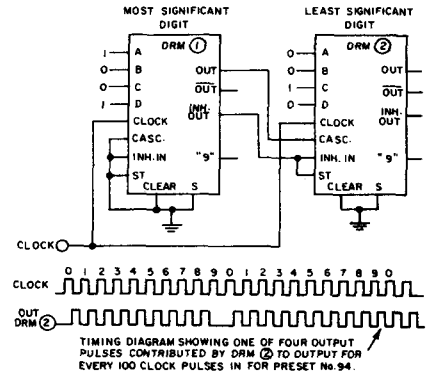

Fig. 12 - Two CD4527B's cascaded in the "Add" mode with a preset number

$$\text{of } 94 \left( \frac{9}{10} + \frac{4}{100} = \frac{94}{100} \right)$$

# CD4527B Types

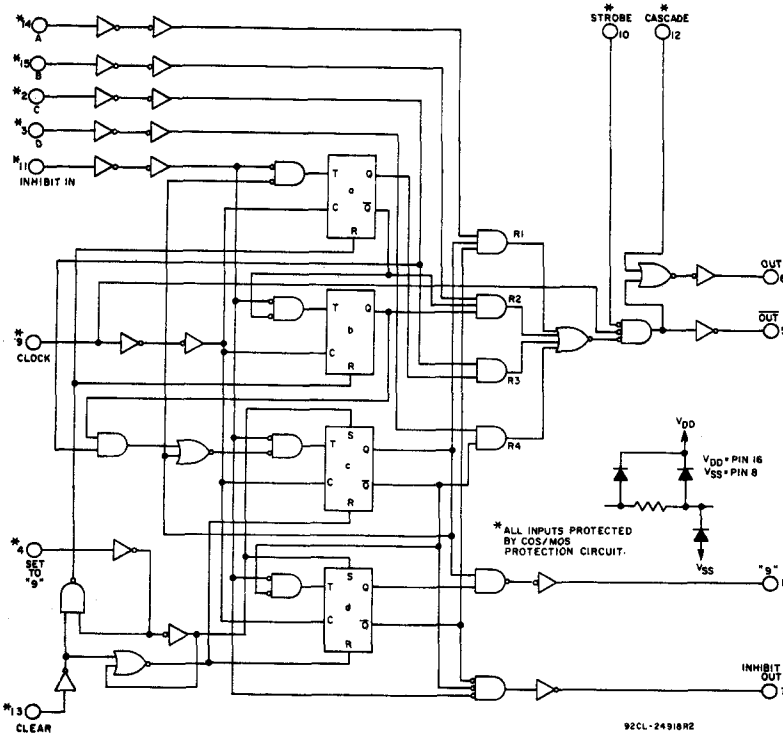

Fig. 13 - Logic diagram.

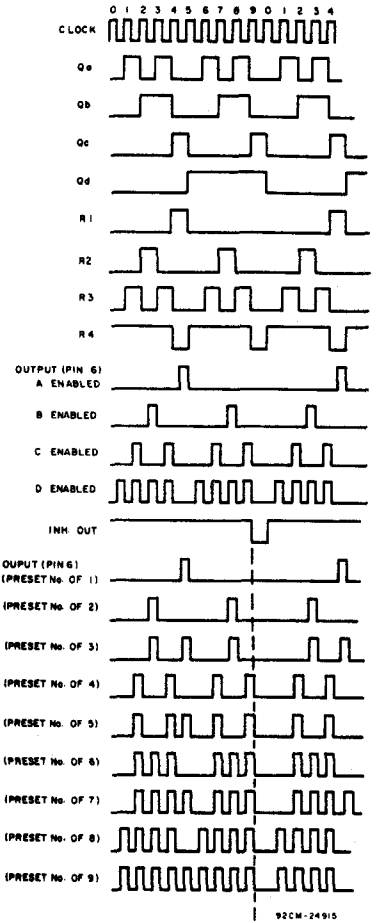
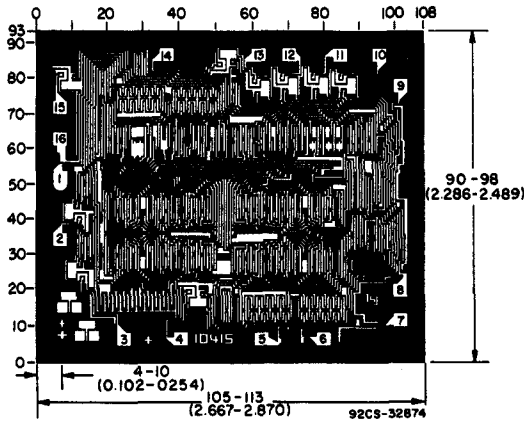

Fig. 14 - Timing diagram (See Logic Diagram).



Dimensions and Pad Layout for CD4527BH

The photographs and dimensions of each CMOS chip represent a chip when it is part of the wafer. When the wafer is separated into individual chips, the angle of cleavage may vary with respect to the chip face for different chips. The actual dimensions of the isolated chip, therefore, may differ slightly from the nominal dimensions shown. The user should consider a tolerance of  $-3$  mils to  $+16$  mils applicable to the nominal dimensions shown.

Dimensions in parentheses are in millimeters and are derived from the basic inch dimensions as indicated. Grid graduations are in mils ( $10^{-3}$  inch).

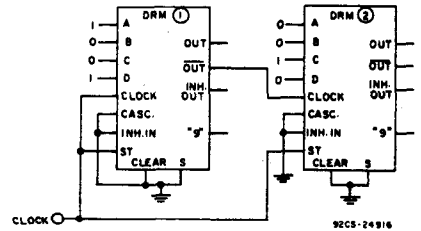

Fig. 15 - Two CD4527B's cascaded in the "Multiply" mode with a preset number

$$\text{of } 36 \left( \frac{9}{10} \times \frac{4}{10} = \frac{36}{100} \right).$$

# CD4527B Types

TRUTH TABLE

INPUTS										OUTPUTS			
Number of Pulses or Input Logic Level (0 = Low; 1 = High; X = Don't Care)										Number of Pulses or Output Logic Level (L = Low; H = High)			
D	C	B	A	CLK	INH IN	STR	CAS	CLR #	SET #	OUT	OUT	INH OUT	"9" OUT
0	0	0	0	10	0	0	0	0	0	L	H	1	1
0	0	0	1	10	0	0	0	0	0	1	1	1	1
0	0	1	0	10	0	0	0	0	0	2	2	1	1
0	0	1	1	10	0	0	0	0	0	3	3	1	1
0	1	0	0	10	0	0	0	0	0	4	4	1	1
0	1	0	1	10	0	0	0	0	0	5	5	1	1
0	1	1	0	10	0	0	0	0	0	6	6	1	1
0	1	1	1	10	0	0	0	0	0	7	7	1	1
1	0	0	0	10	0	0	0	0	0	8	8	1	1
1	0	0	1	10	0	0	0	0	0	9	9	1	1
1	0	1	0	10	0	0	0	0	0	8	8	1	1
1	0	1	1	10	0	0	0	0	0	9	9	1	1
1	1	0	0	10	0	0	0	0	0	8	8	1	1
1	1	0	1	10	0	0	0	0	0	9	9	1	1
1	1	1	0	10	0	0	0	0	0	8	8	1	1
1	1	1	1	10	0	0	0	0	0	9	9	1	1
X	X	X	X	10	1	0	0	0	0	†	†	H	†
X	X	X	X	10	0	1	0	0	0	L	H	1	1
X	X	X	X	10	0	0	1	0	0	H	*	1	1
1	X	X	X	10	0	0	0	1	0	10	10	H	L
0	X	X	X	10	0	0	0	1	0	L	H	H	L
X	X	X	X	10	0	0	0	0	1	L	H	L	H

\* Output same as the first 16 lines of this truth table (depending on values of A, B, C, D).

† Depends on internal state of counter.

#Clear and Set Inputs should not be high at the same time; device draws increased quiescent current when in this non-valid state.

# CD4532B Types

## CMOS 8-Bit Priority Encoder

### High-Voltage Types (20-Volt Rating)

The RCA-CD4532B consists of combination logic that encodes the highest priority input (D7-D0) to a 3-bit binary code. The eight inputs, D7 through D0, each have an assigned priority; D7 is the highest priority and D0 is the lowest. The priority encoder is inhibited when the chip-enable input E<sub>j</sub> is low. When E<sub>j</sub> is high, the binary representation of the highest-priority input appears on output lines Q2-Q0, and the group select line GS is high to indicate that priority inputs are present. The enable-out (E<sub>o</sub>) is high when no priority inputs are present. If any one input is high, E<sub>o</sub> is low and all cascaded lower-order stages are disabled.

The CD4532B types are supplied in 16-lead hermetic dual-in-line ceramic packages (D and F suffixes), 16-lead dual-in-line plastic packages (E suffix), 16-lead ceramic flat packages (K suffix), and in chip form (H suffix).

### Features:

- Converts from 1 of 8 to binary
- Provides cascading feature to handle any number of inputs
- Group select indicates one or more priority inputs
- Standardized, symmetrical output characteristics
- 100% tested for quiescent current at 20 V
- Maximum input current of 1  $\mu$ A at 18 V over full package temperature range; 100 nA at 18 V and 25°C
- Noise margin (full package-temperature range):
  - 1 V at V<sub>DD</sub> = 5 V
  - 2 V at V<sub>DD</sub> = 10 V
  - 2.5 V at V<sub>DD</sub> = 15 V
- 5-V, 10-V, and 15-V parametric ratings
- Meets all requirements of JEDEC Tentative Standard No. 13A, "Standard Specifications for Description of 'B' Series CMOS Devices"

### Applications:

- Priority encoder
- Binary or BCD encoder (keyboard encoding)
- Floating point arithmetic

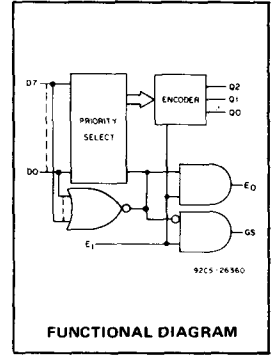

FUNCTIONAL DIAGRAM

### RECOMMENDED OPERATING CONDITIONS

For maximum reliability, nominal operating conditions should be selected so that operation is always within the following ranges.

Characteristic	Min.	Max.	Units
Supply Voltage Range (for T <sub>A</sub> = Full Package Temp. Range)	3	18	V

### MAXIMUM RATINGS, Absolute-Maximum Values:

DC SUPPLY-VOLTAGE RANGE, (V <sub>DD</sub> ) (Voltages referenced to V <sub>SS</sub> Terminal)	-0.5 to +20 V
INPUT VOLTAGE RANGE, ALL INPUTS	-0.5 to V <sub>DD</sub> + 0.5 V
DC INPUT CURRENT, ANY ONE INPUT	±10 mA
POWER DISSIPATION PER PACKAGE (P <sub>D</sub> ):	
For T <sub>A</sub> = -40 to +60°C (PACKAGE TYPE E)	500 mW
For T <sub>A</sub> = +60 to +85°C (PACKAGE TYPE E)	Derate Linearly at 12 mW/°C to 200 mW
For T <sub>A</sub> = -55 to +100°C (PACKAGE TYPES D, F, K)	500 mW
For T <sub>A</sub> = +100 to +125°C (PACKAGE TYPES D, F, K)	Derate Linearly at 12 mW/°C to 200 mW
DEVICE DISSIPATION PER OUTPUT TRANSISTOR	
FOR T <sub>A</sub> = FULL PACKAGE-TEMPERATURE RANGE (All Package Types)	100 mW
OPERATING-TEMPERATURE RANGE (T <sub>A</sub> ):	
PACKAGE TYPES D, F, K, H	-55 to +125°C
PACKAGE TYPE E	-40 to +85°C
STORAGE TEMPERATURE RANGE (T <sub>stg</sub> )	-65 to +150°C
LEAD TEMPERATURE (DURING SOLDERING):	
At distance 1/16 ± 1/32 inch (1.59 ± 0.79 mm) from case for 10 s max.	+265°C

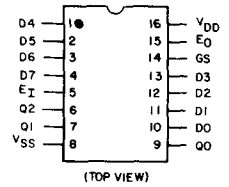

92CS-24596R1

TERMINAL ASSIGNMENT

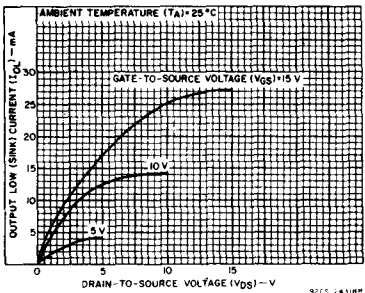

Fig. 1 — Typical output low (sink) current characteristics.

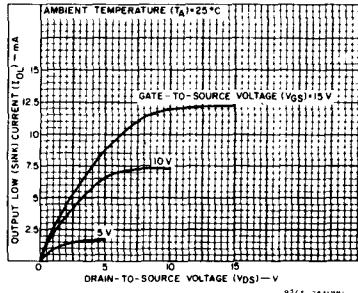

Fig. 2 — Minimum output low (sink) current characteristics.

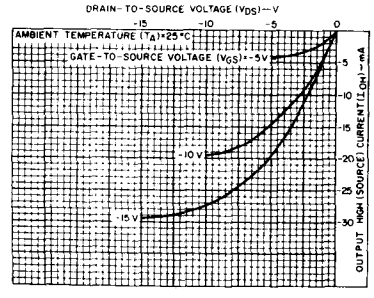

Fig. 3 — Typical output high (source) current characteristics.

# CD4532B Types

## STATIC ELECTRICAL CHARACTERISTICS

CHARACTERISTIC	CONDITIONS			LIMITS AT INDICATED TEMPERATURES (°C)							UNITS
	V <sub>O</sub> (V)	V <sub>IN</sub> (V)	V <sub>DD</sub> (V)					+25			
				-55	-40	+85	+125	Min.	Typ.	Max.	
Quiescent Device Current, I <sub>DD</sub> Max.	-	0,5	5	5	5	150	150	-	0.04	5	μA
	-	0,10	10	10	10	300	300	-	0.04	10	
	-	0,15	15	20	20	600	600	-	0.04	20	
	-	0,20	20	100	100	3000	3000	-	0.08	100	
Output Low (Sink) Current I <sub>OL</sub> Min.	0.4	0,5	5	0.64	0.61	0.42	0.36	0.51	1	-	mA
	0.5	0,10	10	1.6	1.5	1.1	0.9	1.3	2.6	-	
	1.5	0,15	15	4.2	4	2.8	2.4	3.4	6.8	-	
Output High (Source) Current, I <sub>OH</sub> Min.	4.6	0,5	5	-0.64	-0.61	-0.42	-0.36	-0.51	-1	-	mA
	2.5	0,5	5	-2	-1.8	-1.3	-1.15	-1.6	-3.2	-	
	9.5	0,10	10	-1.6	-1.5	-1.1	-0.9	-1.3	-2.6	-	
	13.5	0,15	15	-4.2	-4	-2.8	-2.4	-3.4	-6.8	-	
Output Voltage: Low-Level, V <sub>OL</sub> Max.	-	0,5	5	0.05				-	0	0.05	V
	-	0,10	10	0.05				-	0	0.05	
	-	0,15	15	0.05				-	0	0.05	
Output Voltage: High-Level, V <sub>OH</sub> Min.	-	0,5	5	4.95				4.95	5	-	V
	-	0,10	10	9.95				9.95	10	-	
	-	0,15	15	14.95				14.95	15	-	
Input Low Voltage, V <sub>IL</sub> Max.	0.5, 4.5	-	5	1.5				-	-	1.5	V
	1, 9	-	10	3				-	-	3	
	1.5, 13.5	-	15	4				-	-	4	
Input High Voltage, V <sub>IH</sub> Min.	0.5, 4.5	-	5	3.5				3.5	-	-	V
	1, 9	-	10	7				7	-	-	
	1.5, 13.5	-	15	11				11	-	-	
Input Current I <sub>IN</sub> Max.		0,18	18	±0.1	±0.1	±1	±1	-	±10 <sup>-5</sup>	±0.1	μA

## DYNAMIC ELECTRICAL CHARACTERISTICS at T<sub>A</sub>=25°C; C<sub>L</sub>=50 pF, Input t<sub>r</sub>, t<sub>f</sub> = 20 ns, R<sub>L</sub>=200 KΩ

CHARACTERISTIC	TEST CONDITIONS V <sub>DD</sub> VOLTS	LIMITS ALL TYPES		UNITS
		TYP.	MAX.	
Propagation Delay Time t <sub>PHL</sub> , t <sub>PLH</sub> E <sub>I</sub> to E <sub>O</sub> , E <sub>I</sub> to G <sub>S</sub>	5	110	220	
	10	55	110	
	15	45	85	
E <sub>I</sub> to Q <sub>m</sub> , D <sub>n</sub> to G <sub>S</sub>	5	170	340	ns
	10	85	170	
	15	65	125	
D <sub>n</sub> to Q <sub>M</sub>	5	220	440	ns
	10	110	220	
	15	85	160	
Transition Time t <sub>THL</sub> , t <sub>TLH</sub>	5	100	200	ns
	10	50	100	
	15	40	80	
Input Capacitance C <sub>IN</sub>	Any Input	5	7.5	pF

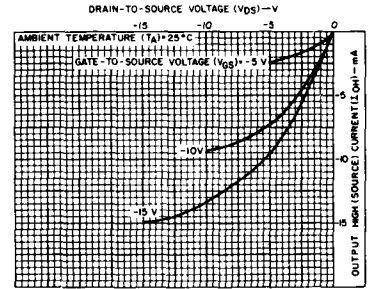

Fig. 4 - Minimum output high (source) current characteristics.

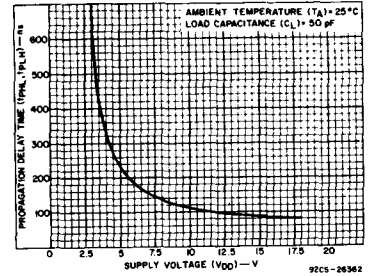

Fig. 5 - Typical propagation delay (D<sub>n</sub> to Q<sub>m</sub>) vs. supply voltage.

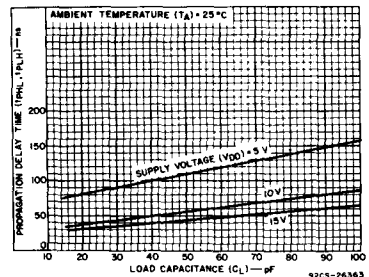

Fig. 6 - Typical propagation delay (E<sub>I</sub> to G<sub>S</sub>, E<sub>I</sub> to E<sub>O</sub>) vs. load capacitance.

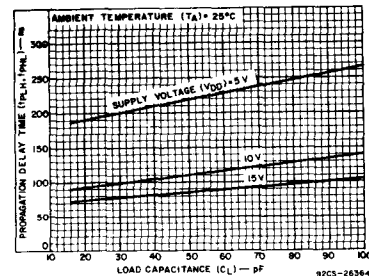

Fig. 7 - Typical propagation delay (D<sub>n</sub> to Q<sub>m</sub>) vs. load capacitance.

# CD4532B Types

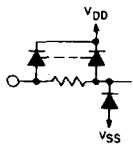
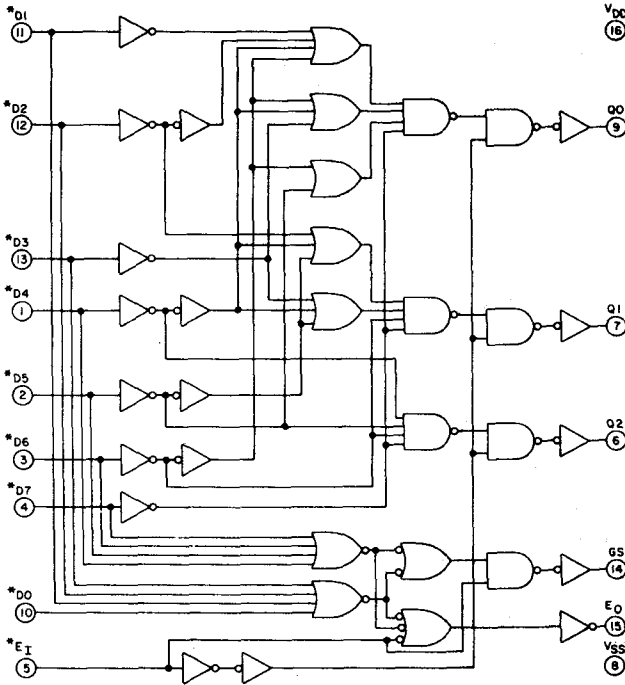

Fig. 8 - CD4532 logic diagram.

\*ALL INPUTS PROTECTED BY COS/MOS PROTECTION NETWORK

92CL-28361R1

## TRUTH TABLE

Input									Output				
E <sub>t</sub>	D <sub>7</sub>	D <sub>6</sub>	D <sub>5</sub>	D <sub>4</sub>	D <sub>3</sub>	D <sub>2</sub>	D <sub>1</sub>	D <sub>0</sub>	GS	Q <sub>2</sub>	Q <sub>1</sub>	Q <sub>0</sub>	E <sub>0</sub>
0	X	X	X	X	X	X	X	X	0	0	0	0	0
1	0	0	0	0	0	0	0	0	0	0	0	0	1
1	1	X	X	X	X	X	X	X	1	1	1	1	0
1	0	1	X	X	X	X	X	X	1	1	1	0	0
1	0	0	1	X	X	X	X	X	1	1	0	1	0
1	0	0	0	1	X	X	X	X	1	1	0	0	0
1	0	0	0	0	1	X	X	X	1	0	1	1	0
1	0	0	0	0	0	1	X	X	1	0	1	0	0
1	0	0	0	0	0	0	1	X	1	0	0	1	0
1	0	0	0	0	0	0	0	1	1	0	0	0	0

X = Don't Care

Logic 1 ≡ High

Logic 0 ≡ Low

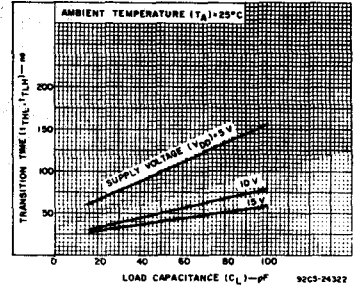

Fig. 9 - Typical transition time vs. load capacitance.

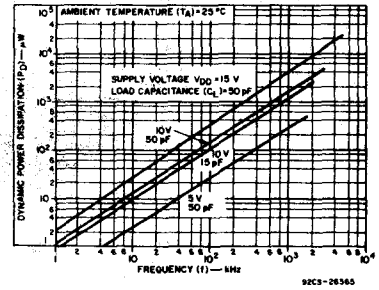

Fig. 10 - Typical dynamic power dissipation vs. frequency.

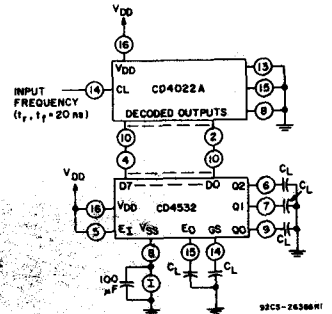

Fig. 11 - Dynamic power dissipation test circuit.

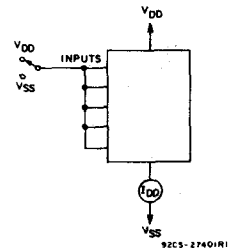

Fig. 12 - Quiescent device current test circuit.

# CD4532B Types

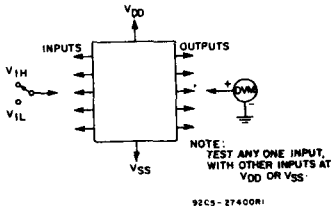

Fig. 13 - Input voltage test circuit.

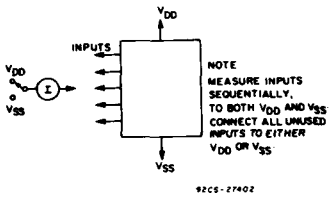
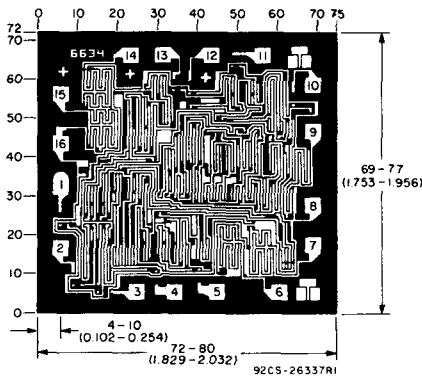

Fig. 14 - Input current test circuit.



Dimensions in parentheses are in millimeters and are derived from the basic inch dimensions as indicated. Grid graduations are in mils ( $10^{-3}$  inch).

The photographs and dimensions of each CMOS chip represent a chip when it is part of the wafer. When the wafer is separated into individual chips, the angle of cleavage may vary with respect to the chip face for different chips. The actual dimensions of the isolated chip, therefore, may differ slightly from the nominal dimensions shown. The user should consider a tolerance of  $-3$  mils to  $+16$  mils applicable to the nominal dimensions shown.

Dimensions and pad layout for CD4532BH.

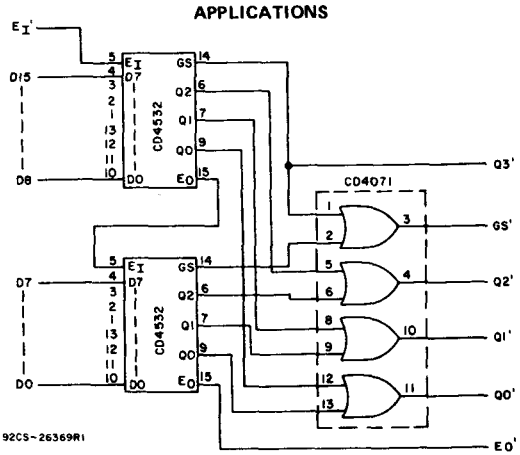
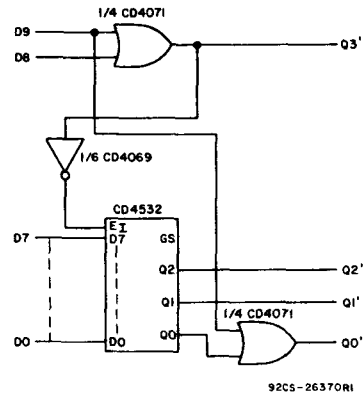

Fig. 15 - 16-level priority encoder.



**TRUTH TABLE**

Input										Output				
D9	D8	D7	D6	D5	D4	D3	D2	D1	D0	GS	Q3'	Q2'	Q1'	Q0'
1	X	X	X	X	X	X	X	X	X	0	1	0	0	1
0	1	X	X	X	X	X	X	X	X	0	1	0	0	0
0	0	1	X	X	X	X	X	X	X	1	0	1	1	1
0	0	0	1	X	X	X	X	X	X	1	0	1	1	0
0	0	0	0	1	X	X	X	X	X	1	0	1	0	1
0	0	0	0	0	1	X	X	X	X	1	0	1	0	0
0	0	0	0	0	0	1	X	X	X	1	0	0	1	1
0	0	0	0	0	0	0	1	X	X	1	0	0	1	0
0	0	0	0	0	0	0	0	1	X	1	0	0	0	1
0	0	0	0	0	0	0	0	0	1	0	1	0	0	0

X = Don't Care      Logic 1  $\equiv$  High      Logic 0  $\equiv$  Low

Fig. 16 - 0-to-9 keyboard encoder.

# CD4536B Types

## CMOS Programmable Timer

High-Voltage Types (20-Volt Rating)

The RCA-CD4536B is a programmable timer consisting of 24 ripple-binary counter stages. The salient feature of this device is its flexibility. The device can count from 1 to  $2^{24}$  or the first 8 stages can be bypassed to allow an output, selectable by a 4-bit code, from any one of the remaining 16 stages. It can be driven by an external clock or an RC oscillator that can be constructed using on-chip components. Input IN1 serves as either the external clock input or the input to the on-chip RC oscillator. OUT1 and OUT2 are connection terminals for the external RC components. In addition, an on-chip monostable circuit is provided to allow a variable pulse width output. Various timing functions can be achieved using combinations of these capabilities.

A logic 1 on the 8-BYPASS input enables a bypass of the first 8 stages and makes stage 9 the first counter stage of the last 16 stages. Selection of 1 of 16 outputs is accomplished by the decoder and the BCD inputs A, B, C and D. MONO IN is the timing input for the on-chip monostable oscillator. Grounding of the MONO IN terminal through a resistor of 10K ohms or higher, disables the one-shot circuit and connects the decoder directly to the DECODE OUT terminal. A resistor to  $V_{DD}$  and a capacitor to ground from the MONO IN terminal enables the one-shot circuit and controls its pulse width.

A fast test mode is enabled by a logic 1 on 8-BYPASS, SET, and RESET. This mode

### Features:

- 24 flip-flop stages — counts from  $2^0$  to  $2^{24}$
- Last 16 stages selectable by BCD select code
- Bypass input allows bypassing first 8 stages
- On-chip RC oscillator provision
- Clock inhibit input
- Schmitt-trigger in clock line permits operation with very long rise and fall times
- On-chip monostable output provision
- Typical  $f_{CL} = 3$  MHz at  $V_{DD} = 10$  V
- Test mode allows fast test sequence
- Set and reset inputs
- Capable of driving two low power TTL loads, one lower-power Schottky load, or two HTL loads over the rated temperature range
- Standardized, symmetrical output characteristics
- 100% tested for quiescent current at 20 V
- 5-V, 10-V, and 15-V parametric ratings
- Meets all requirements of JEDEC Tentative Standard No. 13A, "Standard Specifications for Description of 'B' Series CMOS Devices"

divides the 24-stage counter into three 8-stage sections to facilitate a fast test sequence.

The CD4536B types are supplied in 16-lead hermetic dual-in-line ceramic packages (D and F suffixes), 16-lead dual-in-line plastic packages (E suffix), 16-lead ceramic flat packages (K suffix), and in chip form (H suffix).

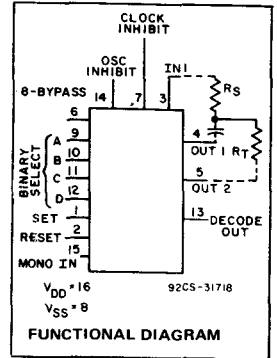

### RECOMMENDED OPERATING CONDITIONS

For maximum reliability, nominal operating conditions should be selected so that operation is always within the following ranges:

CHARACTERISTIC	LIMITS		UNITS
	Min.	Max.	
Supply-Voltage Range (For $T_A =$ Full Package Temperature Range)	3	18	V

### MAXIMUM RATINGS, Absolute-Maximum Values:

DC SUPPLY-VOLTAGE RANGE, ( $V_{DD}$ ) (Voltages referenced to $V_{SS}$ Terminal)	-0.5 to +20 V
INPUT VOLTAGE RANGE, ALL INPUTS	-0.5 to $V_{DD} + 0.5$ V
DC INPUT CURRENT, ANY ONE INPUT	$\pm 10$ mA
POWER DISSIPATION PER PACKAGE ( $P_D$ ):	
For $T_A = -40$ to $+60^\circ\text{C}$ (PACKAGE TYPE E)	500 mW
For $T_A = +60$ to $+85^\circ\text{C}$ (PACKAGE TYPE E)	Derate Linearly at 12 mW/ $^\circ\text{C}$ to 200 mW
For $T_A = -55$ to $+100^\circ\text{C}$ (PACKAGE TYPES D, F, K)	500 mW
For $T_A = +100$ to $+125^\circ\text{C}$ (PACKAGE TYPES D, F, K)	Derate Linearly at 12 mW/ $^\circ\text{C}$ to 200 mW
DEVICE DISSIPATION PER OUTPUT TRANSISTOR	
FOR $T_A =$ FULL PACKAGE-TEMPERATURE RANGE (All Package Types)	100 mW
OPERATING-TEMPERATURE RANGE ( $T_A$ ):	
PACKAGE TYPES D, F, K, H	-55 to $+125^\circ\text{C}$
PACKAGE TYPE E	-40 to $+85^\circ\text{C}$
STORAGE TEMPERATURE RANGE ( $T_{stg}$ )	-65 to $+150^\circ\text{C}$
LEAD TEMPERATURE (DURING SOLDERING):	
At distance 1/16 $\pm$ 1/32 inch (1.59 $\pm$ 0.79 mm) from case for 10 s max.	$+265^\circ\text{C}$

### DECODE OUT SELECTION TABLE

D	C	B	A	NUMBER OF STAGES IN DIVIDER CHAIN	
				8-BYPASS = 0	8-BYPASS = 1
0	0	0	0	9	1
0	0	0	1	10	2
0	0	1	0	11	3
0	0	1	1	12	4
0	1	0	0	13	5
0	1	0	1	14	6
0	1	1	0	15	7
0	1	1	1	16	8
1	0	0	0	17	9
1	0	0	1	18	10
1	0	1	0	19	11
1	0	1	1	20	12
1	1	0	0	21	13
1	1	0	1	22	14
1	1	1	0	23	15
1	1	1	1	24	16

0 = Low Level    1 = High Level



STATIC ELECTRICAL CHARACTERISTICS

CHARACTERISTIC	CONDITIONS			LIMITS AT INDICATED TEMPERATURES (°C)							UNITS
	V <sub>O</sub> (V)	V <sub>IN</sub> (V)	V <sub>DD</sub> (V)	Values at -55, +25, +125 Apply to D, F, K, H Packages				Values at -40, +25, +85 Apply to E Package			
				-55	-40	+85	+125	+25			
								Min.	Typ.	Max.	
Quiescent Device Current, I <sub>DD</sub> Max.	-	0.5	5	5	5	150	150	-	0.04	5	μA
	-	0.10	10	10	10	300	300	-	0.04	10	
	-	0.15	15	20	20	600	600	-	0.04	20	
	-	0.20	20	100	100	3000	3000	-	0.08	100	
Output Low (Sink) Current, I <sub>OL</sub> Min.	0.4	0.5	5	0.64	0.61	0.42	0.36	0.51	1	-	mA
	0.5	0.10	10	1.6	1.5	1.1	0.9	1.3	2.6	-	
	1.5	0.15	15	4.2	4	2.8	2.4	3.4	6.8	-	
Output High (Source) Current, I <sub>OH</sub> Min.	4.6	0.5	5	-0.64	-0.61	-0.42	-0.36	-0.51	-1	-	mA
	2.5	0.5	5	-2	-1.8	-1.3	-1.15	-1.6	-3.2	-	
	9.5	0.10	10	-1.6	-1.5	-1.1	-0.9	-1.3	-2.6	-	
	13.5	0.15	15	-4.2	-4	-2.8	-2.4	-3.4	-6.8	-	
Output Voltage: Low-Level, V <sub>OL</sub> Max.	-	0.5	5	0.05				-	0	0.05	V
	-	0.10	10	0.05				-	0	0.05	
	-	0.15	15	0.05				-	0	0.05	
Output Voltage: High-Level, V <sub>OH</sub> Min.	-	0.5	5	4.95				4.95	5	-	V
	-	0.10	10	9.95				9.95	10	-	
	-	0.15	15	14.95				14.95	15	-	
Input Low Voltage, V <sub>IL</sub> Max.	0.5, 4.5	-	5	1.5				-	-	1.5	V
	1.9	-	10	3				-	-	3	
	1.5, 13.5	-	15	4				-	-	4	
Input High Voltage, V <sub>IH</sub> Min.	0.5, 4.5	-	5	3.5				3.5	-	-	V
	1.9	-	10	7				7	-	-	
	1.5, 13.5	-	15	11				11	-	-	
Input Current, I <sub>IN</sub> Max.	-	0.18	18	±0.1	±0.1	±1	±1	-	±10 <sup>-5</sup>	±0.1	μA

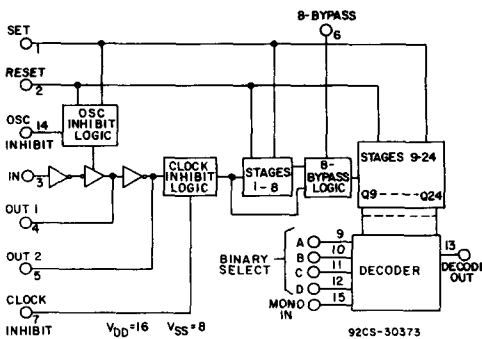

Fig. 1 - Functional block diagram.

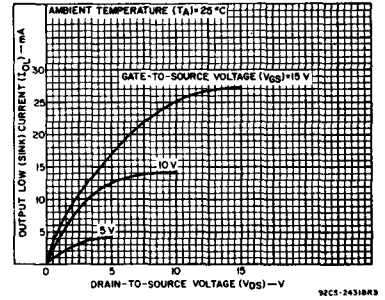

Fig. 2 - Typical output low (sink) current characteristics.

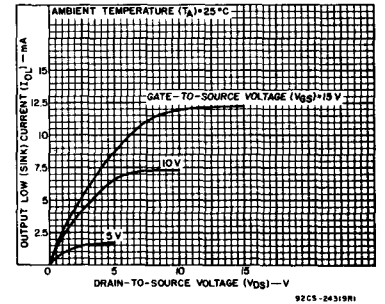

Fig. 3 - Minimum output low (sink) current characteristics.

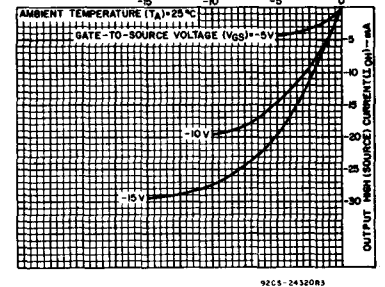

Fig. 4 - Typical output high (source) current characteristics.

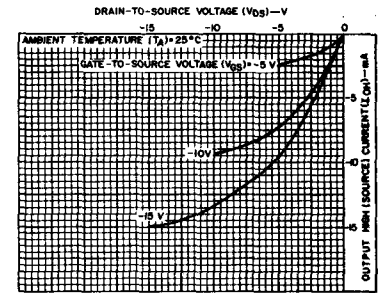

Fig. 5 - Minimum output high (source) current characteristics.

# CD4536B Types

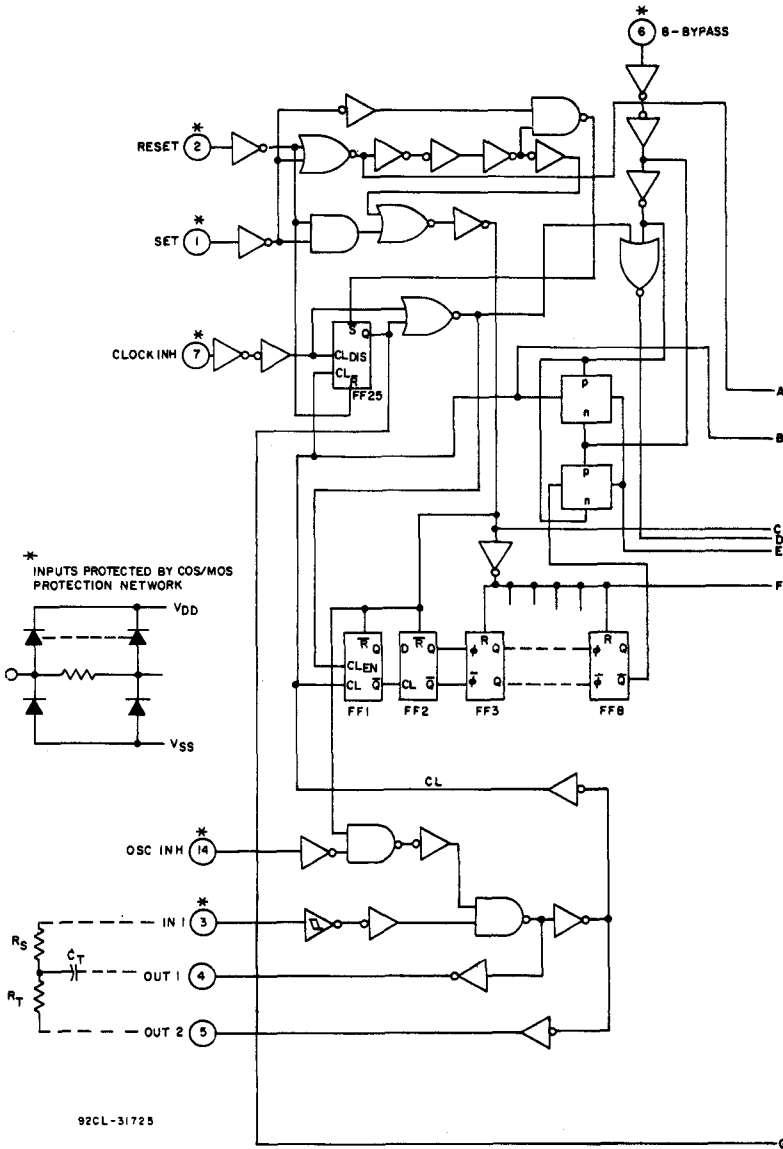

Fig.6 - Logic diagram for CD4536B [continued on next page].

# CD4536B Types

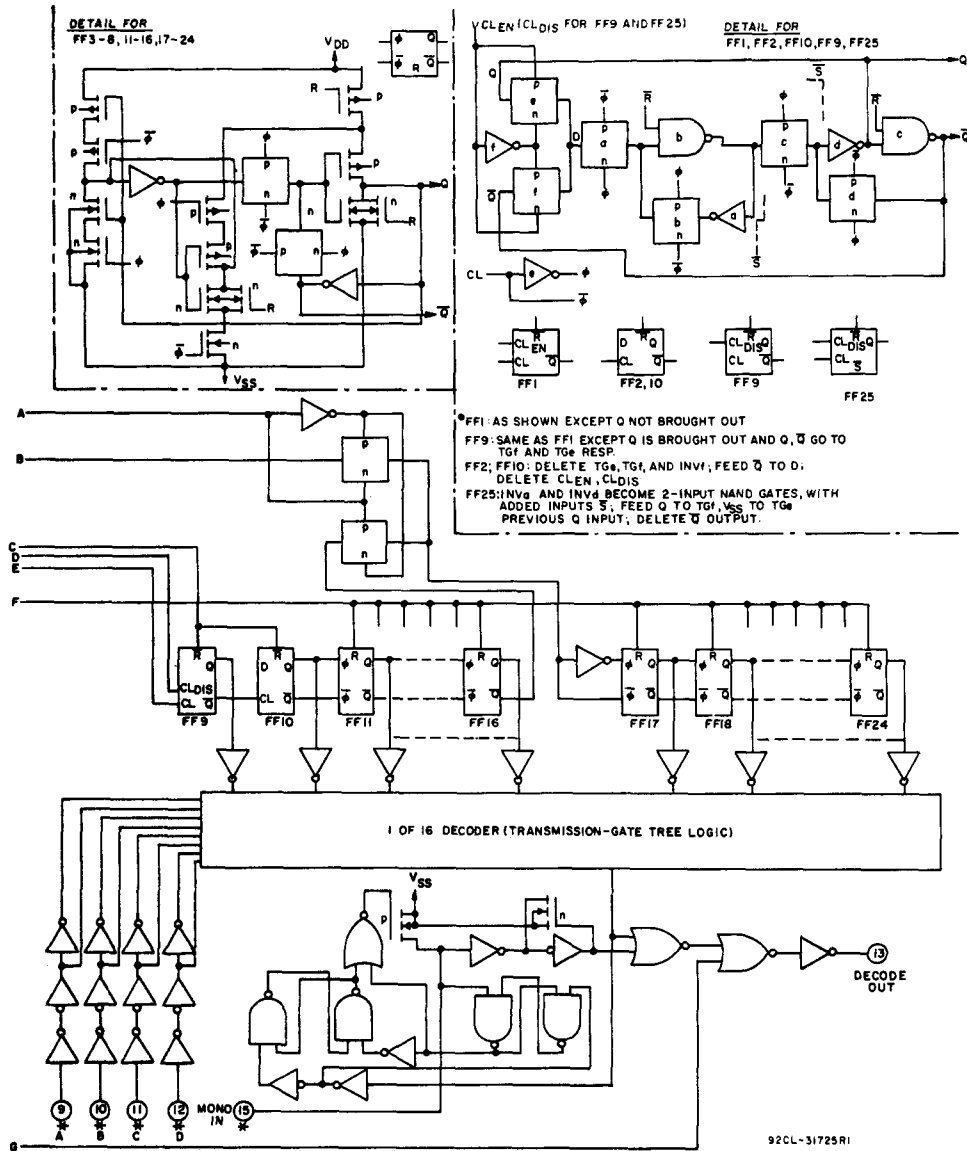
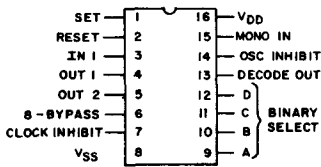

Fig.6 - Logic diagram for CD4536B [continued from previous page].

# CD4536B Types

**DYNAMIC ELECTRICAL CHARACTERISTICS, at  $T_A = 25^\circ\text{C}$ , Input  $t_r, t_f = 20\text{ ns}$ ,  $C_L = 50\text{ pF}$ ,  $R_L = 200\text{ k}\Omega$**

CHARACTERISTIC	VDD (V)	LIMITS			UNITS
		Min.	Typ.	Max.	
Propagation Delay Times: Clock to Q1, 8-Bypass High $t_{PHL}, t_{PLH}$	5	—	1	2	$\mu\text{s}$
	10	—	0.5	1	
	15	—	0.35	0.7	
Clock to Q1, 8-Bypass Low $t_{PHL}, t_{PLH}$	5	—	2.5	5	$\mu\text{s}$
	10	—	0.8	1.6	
	15	—	0.6	1.2	
Clock to Q16, $T_{PHL}, t_{PLH}$	5	—	4	8	$\mu\text{s}$
	10	—	1.5	3	
	15	—	1	2	
$Q_n$ to $Q_{n+1}$ , $t_{PHL}, t_{PLH}$	5	—	150	300	ns
	10	—	75	150	
	15	—	50	100	
Set to $Q_n$ , $t_{PLH}$	5	—	300	600	ns
	10	—	125	250	
	15	—	80	160	
Reset to $Q_n$ , $t_{PHL}$	5	—	3	6	$\mu\text{s}$
	10	—	1	2	
	15	—	0.75	1.5	
Transition Time, $t_{THL}, t_{TLH}$	5	—	100	200	ns
	10	—	50	100	
	15	—	40	80	
Minimum Pulse Widths: Clock	5	—	200	400	ns
	10	—	75	150	
	15	—	50	100	
Set	5	—	200	400	ns
	10	—	100	200	
	15	—	60	120	
Reset	5	—	3	6	$\mu\text{s}$
	10	—	1	2	
	15	—	0.75	1.5	
Minimum Set Recovery Time,	5	—	2.5	5	$\mu\text{s}$
	10	—	1	2	
	15	—	0.6	1.6	
Minimum Reset Recovery Time,	5	—	3.5	7	$\mu\text{s}$
	10	—	1.5	3	
	15	—	1	2	
Maximum Clock Pulse Input Frequency, $f_{CL}$	5	0.5	1	—	MHz
	10	1.5	3	—	
	15	2.5	5	—	
Maximum Clock Pulse Input Rise or Fall Time, $t_r, t_f$	5,10,15	Unlimited			$\mu\text{s}$



**Terminal Assignment**

92CS-31716

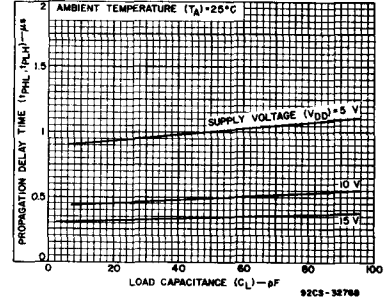

Fig. 7—Typical propagation delay time as a function of load capacitance (CLOCK to  $Q_1$ , 8-BYPASS high).

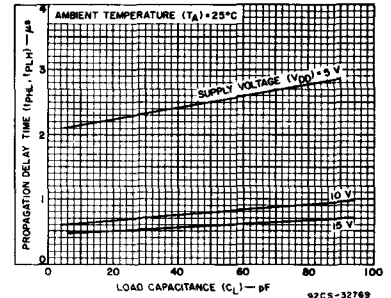

Fig. 8—Typical propagation delay time as a function of load capacitance (CLOCK to  $Q_1$ , 8-BYPASS low).

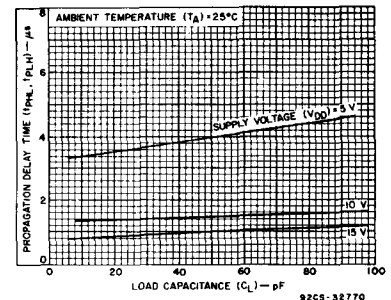

Fig. 9—Typical propagation delay time as a function of load capacitance (CLOCK to  $Q_{16}$ , 8-BYPASS high).

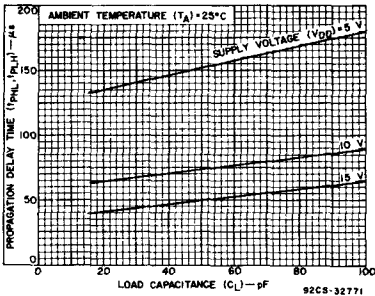

Fig. 10—Typical propagation delay time as a function of load capacitance ( $Q_N$  to  $Q_{N+1}$ ).

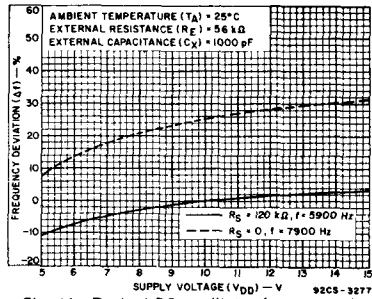

Fig. 11—Typical RC oscillator frequency deviation as a function of supply voltage.

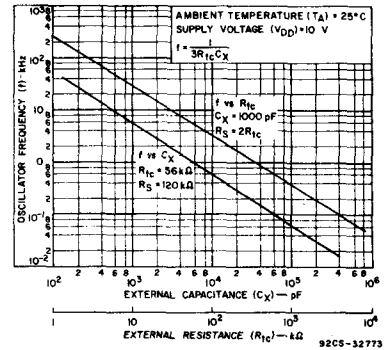

Fig. 12—Typical RC oscillator frequency deviation as a function of time constant resistance and capacitance.

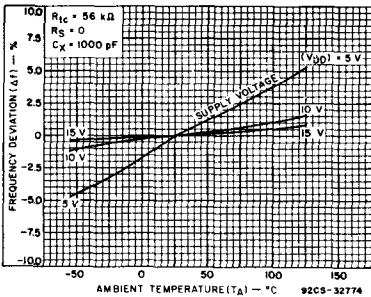

Fig. 13—Typical RC oscillator frequency deviation as a function of ambient temperature ( $R_S = 0$ ).

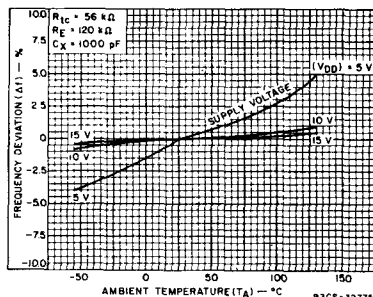

Fig. 14—Typical RC oscillator frequency deviation as a function of ambient temperature ( $R_S = 120 \text{ k}\Omega$ ).

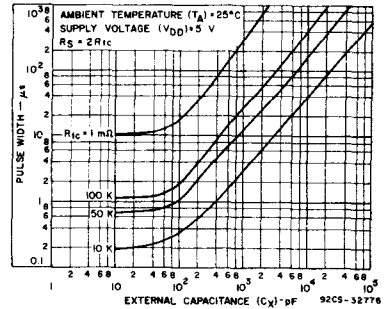

Fig. 15—Typical pulse width as a function of external capacitance ( $V_{DD} = 5 \text{ V}$ ).

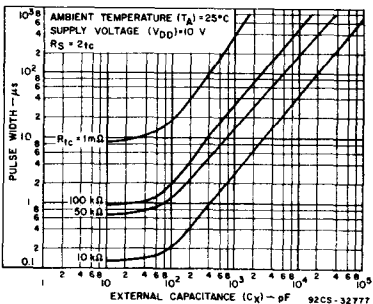

Fig. 16—Typical pulse width as a function of external capacitance ( $V_{DD} = 10 \text{ V}$ ).

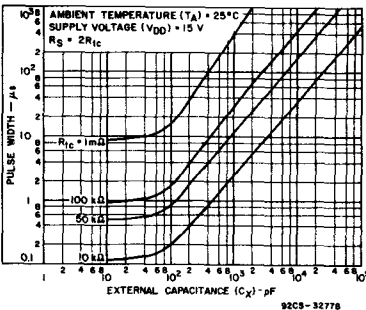

Fig. 17—Typical pulse width as a function of external capacitance ( $V_{DD} = 15 \text{ V}$ ).

Functional Test Sequence					
Inputs				Outputs	Comments
$In_1$	Set	Reset	8-Bypass	Decode Out Q1 thru Q24	
1	0	1	1	0	All 24 steps are in Reset mode
1	1	1	1	0	
0	1	1	1	0	Counter is in three 8-stage section in parallel mode
1	0	1	1	0	First "1" to "0" transition of clock
0	1	1	1	1	255 "1" to "0" transitions are clocked in the counter
0	1	1	1	1	The 255 "1" to "0" transition
0	0	0	0	1	Counter converted back to 24 stages in series mode
1	0	0	0	1	Set and Reset must be connected together and simultaneously go from "1" to "0"
0	0	0	0	0	$In_1$ Switches to a "1"
0	0	0	0	0	Counter Ripples from an all "1" state to an all "0" state

## FUNCTIONAL TEST SEQUENCE

Test Function (Figure 23) has been included for the reduction of test time required to exercise all 24 counter stages. This test function divides the counter into three 8-stage sections and 255 counts are

loaded in each of the 8-stage sections in parallel. All flip-flops are now at a "1". The counter is now returned to the normal 24-steps in series configuration. One more pulse is entered into  $In_1$  which will cause the counter to ripple from an all "1" state to an all "0" state.

# CD4536B Types

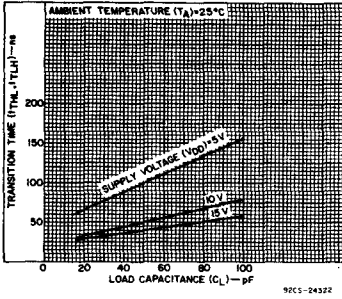

Fig. 18—Typical transition time as a function of load capacitance.

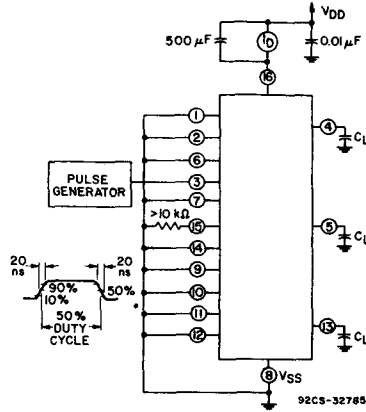

Fig. 20—Dynamic power dissipation test circuit and waveform.

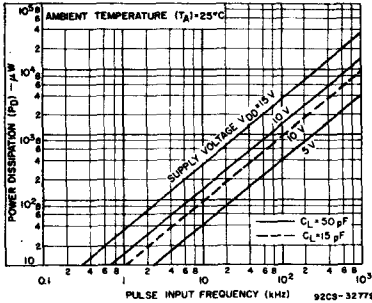

Fig. 19—Typical dynamic power dissipation as a function of input pulse frequency.

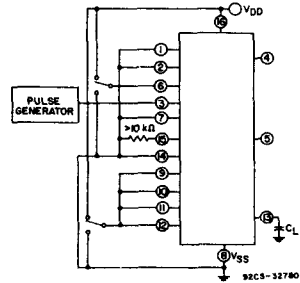

Fig. 21—Switching time test circuit.

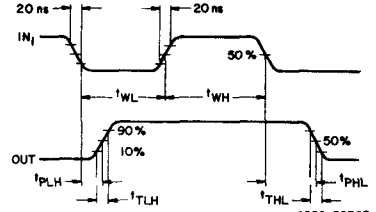

Fig. 22—Input waveforms for switching-time test circuit.

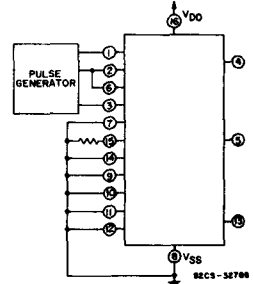

Fig. 23—Functional test circuit.

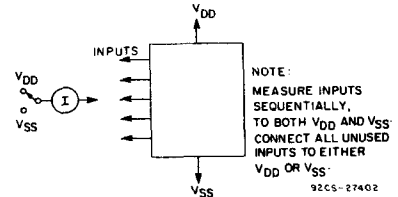

Fig. 24—Input-current test circuit.

### TRUTH TABLE

IN1	SET	RESET	CLOCK INH	OSC INH	OUT1	OUT2	DECODE OUT
	0	0	0	0			No Change
	0	0	0	0			Advance to Next State
X	1	0	0	0	0	1	1
X	0	1	0	0	0	1	0
X	0	0	1	0			No Change
0	0	0	0	X	0	1	No Change
1	0	0	0				Advance to Next State

0 = Low Level    1 = High Level    X = Don't Care

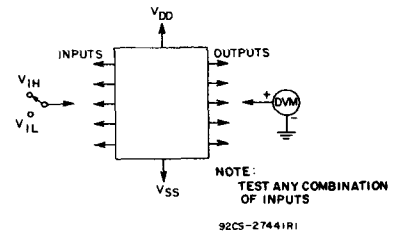

Fig. 25—Input-voltage test circuit.

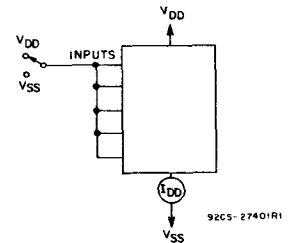

Fig. 26—Quiescent-device current test circuit.

## APPLICATIONS

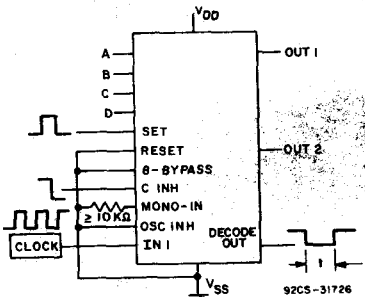

Fig. 27—Time interval configuration using external clock; set and clock inhibit functions.

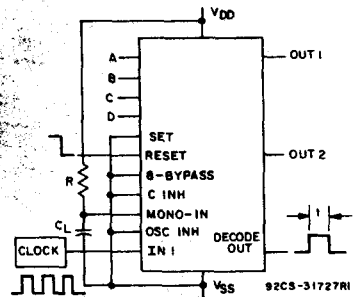

Fig. 28—Time interval configuration using external clock; reset and output monostable to achieve a pulse output.

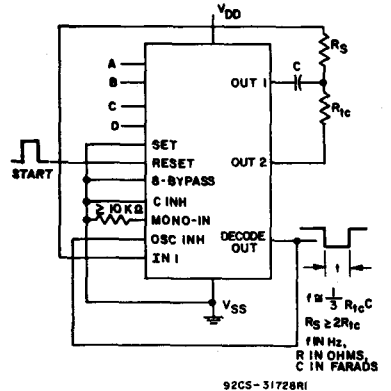

Fig. 29—Time interval configuration using on-chip RC oscillator and reset input to initiate time interval.

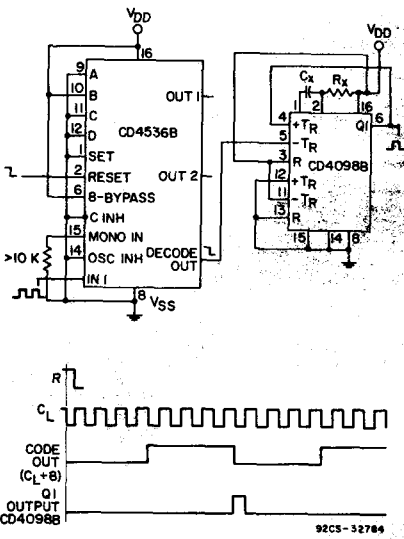
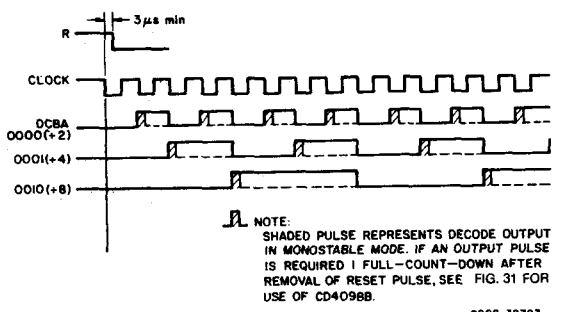

Fig. 30—Application showing use of CD4098B and CD4536B to get decode pulse 8 clock pulses after Reset pulse.



NOTE:  
SHADED PULSE REPRESENTS DECODE OUTPUT IN MONOSTABLE MODE. IF AN OUTPUT PULSE IS REQUIRED 1 FULL-COUNT-DOWN AFTER REMOVAL OF RESET PULSE, SEE FIG. 31 FOR USE OF CD4098B.

Fig. 31—CD4536B Timing Diagram.

### Dimensions and pad layout for CD4536BH.

Dimensions in parentheses are in millimeters and are derived from the basic inch dimensions as indicated. Grid graduations are in mils ( $10^{-3}$  inch).  
The photographs and dimensions of each CMOS chip represent a chip when it is part of the wafer. When the wafer is separated into individual chips, the angle of cleavage may vary with respect to the chip face for different chips. The actual dimensions of the isolated chip, therefore, may differ slightly from the nominal dimensions shown. The user should consider a tolerance of  $-3$  mils to  $+16$  mils applicable to the nominal dimensions shown.

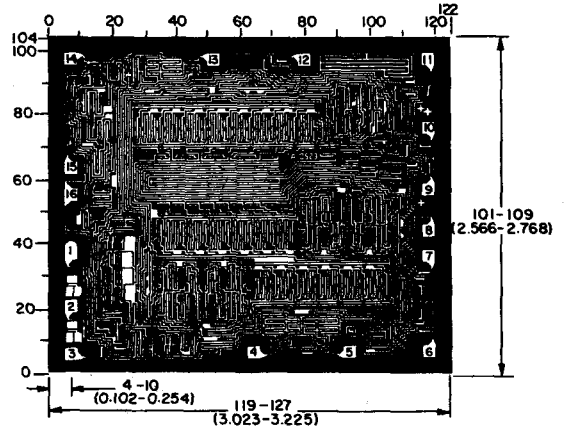

92CM-32787

## CD4538B Types

# CMOS Dual Precision Monostable Multivibrator

High-Voltage Types (20-Volt Rating)

### Features:

- Retriggerable/resettable capability
- Trigger and reset propagation delays independent of  $R_x$ ,  $C_x$
- Triggering from leading or trailing edge
- $Q$  and  $\bar{Q}$  buffered outputs available
- Separate resets
- Wide range of output-pulse widths
- Schmitt trigger input allows unlimited rise and fall times on  $+TR$  and  $-TR$  inputs

The RCA-CD4538B dual precision monostable multivibrator provides stable retriggerable/resettable one-shot operation for any fixed-voltage timing application.

An external resistor ( $R_x$ ) and an external capacitor ( $C_x$ ) control the timing and accuracy for the circuit. Adjustment of  $R_x$  and  $C_x$  provides a wide range of output pulse widths from the  $Q$  and  $\bar{Q}$  terminals. The time delay from trigger input to output transition (trigger propagation delay) and the time delay from reset input to output transition (reset propagation delay) are independent of  $R_x$  and  $C_x$ . Precision control of output pulse widths is achieved through linear CMOS techniques.

Leading-edge-triggering ( $+TR$ ) and trailing-edge-triggering ( $-TR$ ) inputs are provided for triggering from either edge of an input pulse. An unused  $+TR$  input should be tied to  $V_{SS}$ . An unused  $-TR$  input should be tied to  $V_{DD}$ . A RESET (on low level) is provided for immediate termination of the output pulse or to prevent output pulses when power is turned on. An unused RESET input should be tied to  $V_{DD}$ . However, if an entire section of the CD4538B is not used, its inputs must be tied to either  $V_{DD}$  or  $V_{SS}$ . See Table 1.

In normal operation the circuit retriggers (extends the output pulse one period) on the application of each new trigger pulse. For operation in the non-retriggerable mode,  $\bar{Q}$  is connected to  $-TR$  when leading-edge triggering ( $+TR$ ) is used or  $Q$  is connected to  $+TR$  when trailing-edge triggering ( $-TR$ ) is used. The time period ( $T$ ) for this multivibrator can be calculated by:  $T=R_x C_x$ .

The minimum value of external resistance,  $R_x$ , is 4 K $\Omega$ . The maximum and minimum values of external capacitance,  $C_x$ , are 100  $\mu F$  and 5000 pF, respectively.

The CD4538B types are supplied in 16-lead hermetic dual-in-line ceramic packages (D and F suffixes), 16-lead dual-in-line plastic packages (E suffix), 16-lead ceramic flat packages (K suffix), and in chip form (H suffix).

The CD4538B is similar to type MC14538 and is pin-for-pin compatible with the CD4098B.

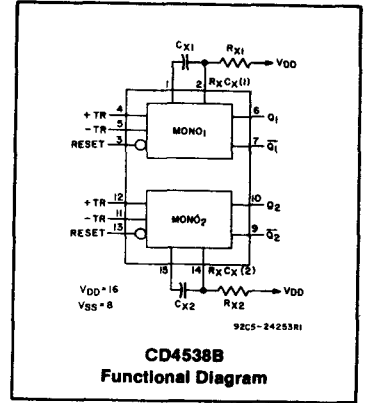

- 100% tested for maximum quiescent current at 20 V
- Maximum input current of 1  $\mu A$  at 18 V over full package-temperature range; 100 nA at 18 V and 25 $^{\circ}C$
- Noise margin (full package-temperature range):
  - 1 V at  $V_{DD}=5$  V
  - 2 V at  $V_{DD}=10$  V
  - 2.5 V at  $V_{DD}=15$  V
- 5-V, 10-V, and 15-V parametric ratings
- Standardized, symmetrical output characteristics
- Meets all requirements of JEDEC Tentative Standard No. 13B, "Standard Specifications for Description of 'B' Series CMOS Devices."

### Applications:

- Pulse delay and timing
- Pulse shaping

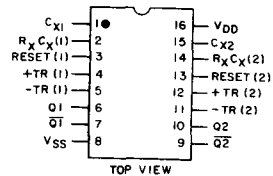

TERMINALS 1, 8, 15 ARE ELECTRICALLY CONNECTED INTERNALLY  
92CS-24846R1

### Terminal Assignment



# CD4538B Types

## MAXIMUM RATINGS, Absolute-Maximum Values:

DC SUPPLY-VOLTAGE RANGE, ( $V_{DD}$ )	(Voltages referenced to $V_{SS}$ Terminal)	-0.5 to +20 V
INPUT VOLTAGE RANGE, ALL INPUTS		-0.5 to $V_{DD}$ +0.5 V
DC INPUT CURRENT, ANY ONE INPUT		$\pm 10$ mA
POWER DISSIPATION PER PACKAGE ( $P_D$ ):		
For $T_A = -40$ to $+60^\circ\text{C}$ (PACKAGE TYPE E)		500 mW
For $T_A = +60$ to $+85^\circ\text{C}$ (PACKAGE TYPE E)		Derate Linearly at 12 mW/ $^\circ\text{C}$ to 200 mW
For $T_A = -55$ to $+100^\circ\text{C}$ (PACKAGE TYPES D,F,K)		500 mW
For $T_A = +100$ to $+125^\circ\text{C}$ (PACKAGE TYPES D,F,K)		Derate Linearly at 12 mW/ $^\circ\text{C}$ to 200 mW
DEVICE DISSIPATION PER OUTPUT TRANSISTOR		
FOR $T_A = \text{FULL PACKAGE-TEMPERATURE RANGE}$ (All Package Types)		100 mW
OPERATING-TEMPERATURE RANGE ( $T_A$ ):		
PACKAGE TYPES D,F,K,H		-55 to $+125^\circ\text{C}$
PACKAGE TYPE E		-40 to $+85^\circ\text{C}$
STORAGE TEMPERATURE RANGE ( $T_{stg}$ )		-65 to $+150^\circ\text{C}$
LEAD TEMPERATURE (DURING SOLDERING):		
At distance $1/16 \pm 1/32$ in. ( $1.59 \pm 0.79$ mm) from case for 10 s max.		$+265^\circ\text{C}$

## RECOMMENDED OPERATING CONDITIONS

For maximum reliability, nominal operating conditions should be selected so that operating is always within the following ranges:

CHARACTERISTIC	$V_{DD}$ (V)	LIMITS		UNITS
		Min.	Max.	
Supply-Voltage Range (For $T_A = \text{Full Package-Temperature Range}$ )	—	3	18	V
Input Pulse Width +TR, -TR, or RESET				
	5	140	—	ns
	10	80	—	
	15	60	—	

TABLE I  
CD4538B FUNCTIONAL TERMINAL CONNECTIONS

FUNCTION	$V_{DD}$ TO TERM. NO.		$V_{SS}$ TO TERM. NO.		INPUT PULSE TO TERM. NO.		OTHER CONNECTIONS	
	MONO <sub>1</sub>	MONO <sub>2</sub>	MONO <sub>1</sub>	MONO <sub>2</sub>	MONO <sub>1</sub>	MONO <sub>2</sub>	MONO <sub>1</sub>	MONO <sub>2</sub>
Leading-Edge Trigger/ Retriggerable	3, 5	11, 13			4	12		
Leading-Edge Trigger/ Non-Retriggerable	3	13			4	12	5-7	11-9
Trailing-Edge Trigger/ Retriggerable	3	13	4	12	5	11		
Trailing-Edge Trigger/ Non-Retriggerable	3	13			5	11	4-6	12-10

### NOTES:

- A RETRIGGERABLE ONE-SHOT MULTIVIBRATOR HAS AN OUTPUT PULSE WIDTH WHICH IS EXTENDED ONE FULL TIME PERIOD (T) AFTER APPLICATION OF THE LAST TRIGGER PULSE.
- A NON-RETRIGGERABLE ONE-SHOT MULTIVIBRATOR HAS A TIME PERIOD (T) REFERENCED FROM THE APPLICATION OF THE FIRST TRIGGER PULSE.

INPUT PULSE TRAIN



RETRIGGERABLE MODE PULSE WIDTH (+TR MODE)

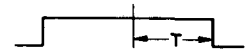

NON-RETRIGGERABLE MODE PULSE WIDTH (+TR MODE)

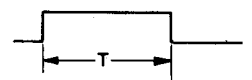

92CS-32816

# CD4538B Types

## STATIC ELECTRICAL CHARACTERISTICS

CHARACTERISTIC	CONDITIONS			LIMITS AT INDICATED TEMPERATURES (°C)							UNITS
				Values at -55, +25, +125 Apply to D, F, K, H Pkgs. Values at -40, +25, +85 Apply to E Pkgs.							
	V <sub>O</sub> (V)	V <sub>IN</sub> (V)	V <sub>DD</sub> (V)	-55	-40	+85	+125	Min.	+25 Typ.	Max.	
Quiescent Device Current, I <sub>DD</sub> Max.	—	0,5	5	5	5	150	150	—	0,04	5	μA
	—	0,10	10	10	10	300	300	—	0,04	10	
	—	0,15	15	20	20	600	600	—	0,04	20	
	—	0,20	20	100	100	3000	3000	—	0,08	100	
Output Low (Sink) Current, I <sub>OL</sub> Min.	0,4	0,5	5	0,64	0,61	0,42	0,36	0,51	1	—	mA
	0,5	0,10	10	1,6	1,5	1,1	0,9	1,3	2,6	—	
	1,5	0,15	15	4,2	4	2,8	2,4	3,4	6,8	—	
Output High (Source) Current, I <sub>OH</sub> Min.	4,6	0,5	5	-0,64	-0,61	-0,42	-0,36	-0,51	-1	—	mA
	2,5	0,5	5	-2	-1,8	-1,3	-1,15	-1,6	-3,2	—	
	9,5	0,10	10	-1,6	-1,5	-1,1	-0,9	-1,3	-2,6	—	
Output Voltage: Low-Level, V <sub>OL</sub> Max.	—	0,5	5				0,05	—	0	0,05	V
	—	0,10	10				0,05	—	0	0,05	
	—	0,15	15				0,05	—	0	0,05	
Output Voltage: High-Level, V <sub>OH</sub> Min.	—	0,5	5				4,95	4,95	5	—	V
	—	0,10	10				9,95	9,95	10	—	
	—	0,15	15				14,95	14,95	15	—	
Input Low Voltage, V <sub>IL</sub> Max.	0,5,4,5	—	5				1,5	—	—	1,5	V
	1,9	—	10				3	—	—	3	
	1,5,13,5	—	15				4	—	—	4	
Input High Voltage, V <sub>IH</sub> Min.	0,5,4,5	—	5				3,5	3,5	—	—	V
	1,9	—	10				7	7	—	—	
	1,5,13,5	—	15				11	11	—	—	
Input Current, I <sub>IN</sub> Max.	—	0,18	18	±0,1	±0,1	±1	±1	—	±10 <sup>-5</sup>	±0,1	μA

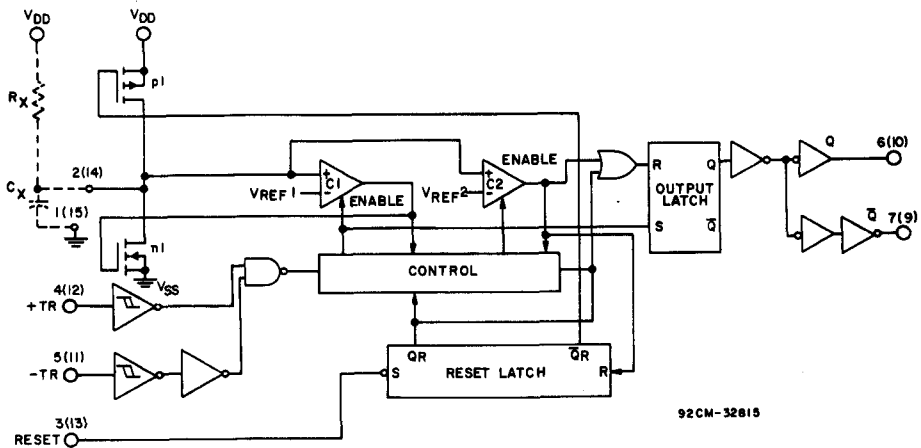

Fig. 1 - Logic diagram (1/2 of device shown).

# CD4538B Types

**DYNAMIC ELECTRICAL CHARACTERISTICS, At  $T_A=25^\circ\text{C}$ ; Input  $t_r, t_f=20\text{ ns}$ ,  $C_L=50\text{ pF}$**

CHARACTERISTIC	TEST CONDITIONS	LIMITS			UNITS	
		$V_{DD}$ (V)	Min.	Typ.		Max.
Transition Time $t_{TLH}, t_{THL}$		5	—	100	200	
		10	—	50	100	
		15	—	40	80	
Propagation Delay Time: +TR or -TR to Q or $\bar{Q}$	$t_{PLH}, t_{PHL}$	5	—	300	600	ns
		10	—	150	300	
		15	—	100	220	
Reset to Q or $\bar{Q}$		5	—	250	500	
		10	—	125	250	
		15	—	95	190	
Minimum Input Pulse Width: +TR, -TR or Reset	$t_{WH}, t_{WL}$	5	—	80	140	
		10	—	40	80	
		15	—	30	60	
Output Pulse Width - Q or $\bar{Q}$ : $C_x=0.005\text{ }\mu\text{F}$ , $R_x=10\text{ K}\Omega$ *	T	5	57	60.6	64.5	$\mu\text{s}$
		10	55	58.9	63.0	
		15	55	59.1	63.5	
$C_x=0.1\text{ }\mu\text{F}$ , $R_x=100\text{ K}\Omega$	T	5	9.4	9.97	10.5	ms
		10	9.4	9.95	10.6	
		15	9.5	10.00	10.6	
$C_x=10\text{ }\mu\text{F}$ , $R_x=100\text{ K}\Omega$	T	5	0.95	1.00	1.06	s
		10	0.95	1.00	1.06	
		15	0.96	1.01	1.07	
Pulse Width Match between circuits in same package: $C_x=0.1\text{ }\mu\text{F}$ , $R_x=100\text{ K}\Omega$	$100(T_1-T_2)$ $T_1$	5	—	$\pm 1$	—	%
		10	—	$\pm 1$	—	
		15	—	$\pm 1$	—	
Minimum Retrigger Time	$t_{rr}$	5	0	—	—	ns
		10	0	—	—	
		15	0	—	—	
Input Capacitance	$C_{IN}$	Any Input	—	5.0	7.5	pF

\*Note: Minimum  $R_x$  value=4 K $\Omega$ , minimum  $C_x$  value=5000 pF.

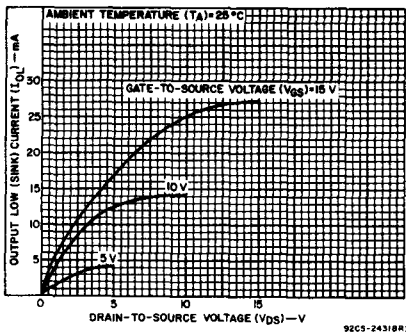

Fig. 2 - Typical output low (sink) current characteristics.

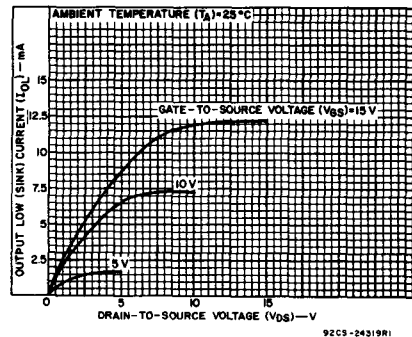

Fig. 3 - Minimum output low (sink) current characteristics.

# CD4538B Types

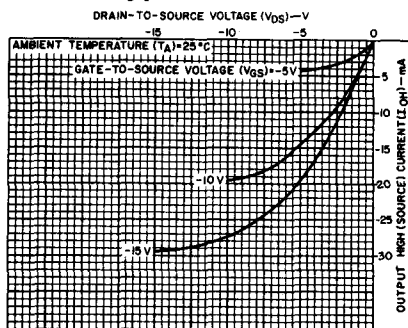

Fig. 4 - Typical output high (source) current characteristics.

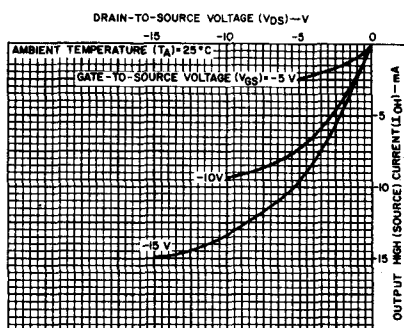

Fig. 5 - Minimum output high (source) current characteristics.

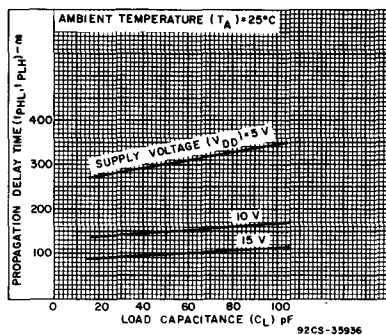

Fig. 6 - Typical propagation delay time as a function of load capacitance (+TR or -TR to Q or Q-bar).

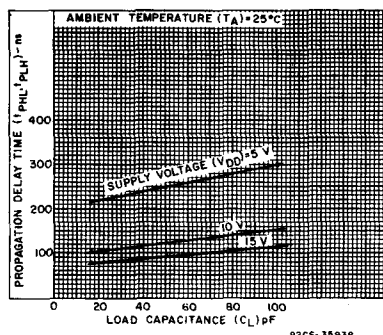

Fig. 7 - Typical propagation delay time as a function of load capacitance (RESET to Q or Q-bar).

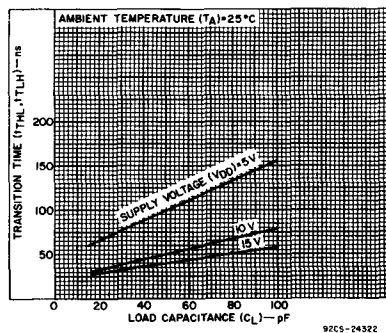

Fig. 8 - Typical transition time as a function of load capacitance.

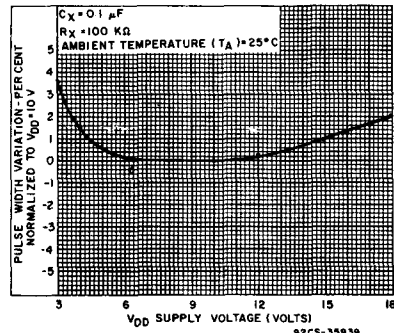

Fig. 9 - Typical pulse-width variation as a function of supply voltage.

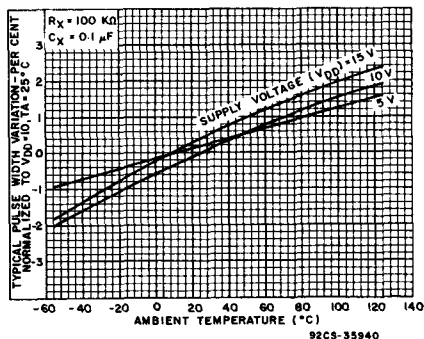

Fig. 10 - Typical pulse-width variation as a function of temperature ( $R_X=100\text{ K}\Omega$ ,  $C_X=0.1\ \mu\text{F}$ ).

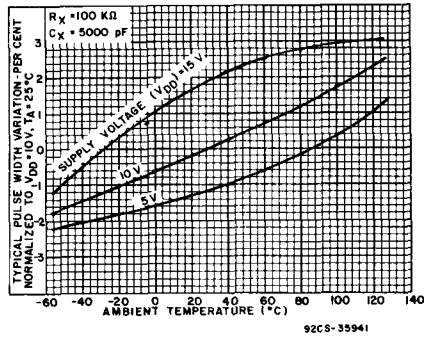

Fig. 11 - Typical pulse-width variation as a function of temperature ( $R_X=100\text{ K}\Omega$ ,  $C_X=5000\text{ pF}$ ).

# CD4538B Types

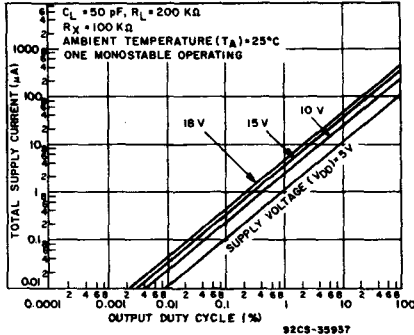

Fig. 12 - Typical total supply current as a function of output duty cycle.

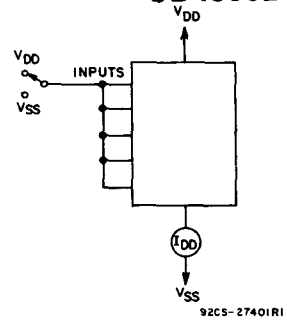
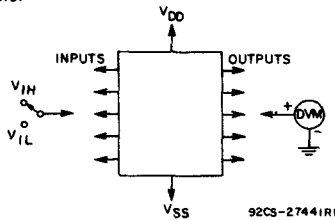

Fig. 13 - Quiescent device current test circuit.



Test any combination of inputs.  
Fig. 14 - Input-voltage test circuit.

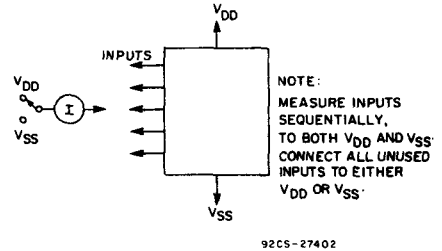

Fig. 15 - Input-leakage-current test circuit.

## Power-Down Mode

During a rapid power-down condition, as would occur with a power-supply short circuit or with a poorly filtered power supply, the energy stored in  $C_x$  could discharge into Pin 2 or 14. To avoid possible device damage in this mode, when  $C_x$  is  $\geq 0.5$  microfarad, a protection diode with a 1-ampere or higher rating (1N5395 or equivalent) and a separate ground return for  $C_x$  should be provided as shown in Fig. 16.

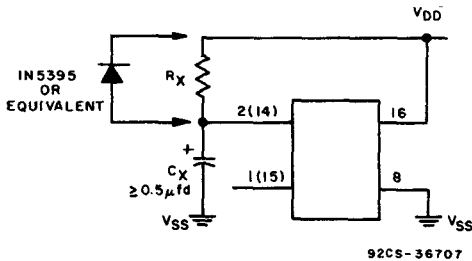

Fig. 16 - Rapid power-down protection circuit.

An alternate protection method is shown in Fig. 17, where a 51-ohm current-limiting resistor is inserted in series with  $C_x$ . Note that a small pulse width decrease will occur however, and  $R_x$  must be appropriately increased to obtain the originally desired pulse width.

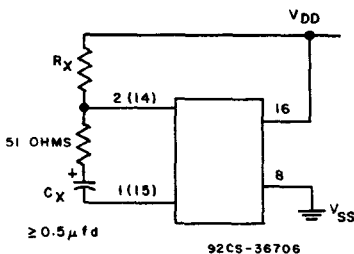
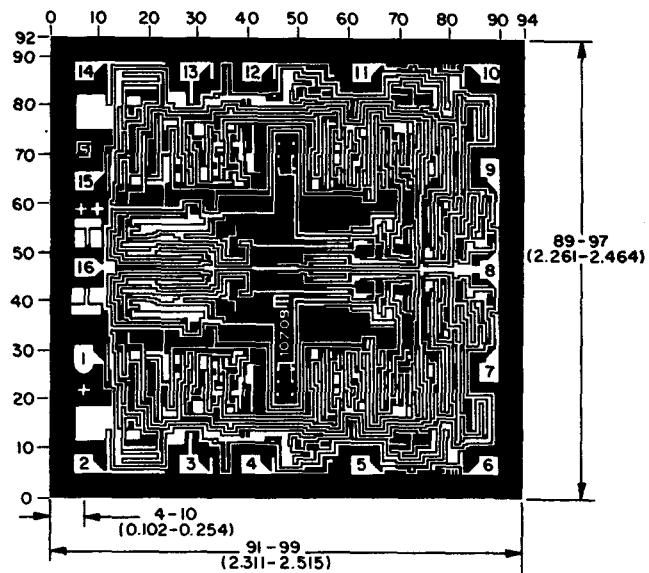

Fig. 17 - Alternate rapid power-down protection circuit.



Dimensions in parentheses are in millimeters and are derived from the basic inch dimension as indicated. Grid graduations are in mils ( $10^{-3}$  inch).

The photographs and dimensions of each CMOS chip represent a chip when it is part of the wafer. When the wafer is separated into individual chips, the angle of cleavage may vary with respect to the chip face for different chips. The actual dimensions of the isolated chip, therefore, may differ slightly from the nominal dimensions shown. The user should consider a tolerance of  $-3$  mils to  $+16$  mils applicable to the nominal dimensions shown.

## CD4541B Types

# CMOS Programmable Timer

High-Voltage Types (20-Volt Rating)

### Features:

- Low symmetrical output resistance, typically 100Ω at  $V_{DD} = 15\text{ V}$
- Built-in low-power RC oscillator
- Oscillator frequency range: DC to 100 kHz
- External clock (applied to pin 3) can be used instead of oscillator
- Operates as  $2^N$  frequency divider or as a single-transition timer
- Q/Q̄ select provides output logic level flexibility
- AUTO or MASTER RESET disables oscillator during reset to reduce power dissipation
- Operates with very slow clock rise and fall times

The RCA-CD4541B programmable timer consists of a 16-stage binary counter, an oscillator that is controlled by external R-C components (2 resistors and a capacitor), an automatic power-on reset circuit, and output control logic. The counter increments on positive-edge clock transitions and can also be reset via the MASTER RESET input.

The output from this timer is the Q or Q̄ output from the 8th, 10th, 13th, or 16th counter stage. The desired stage is chosen using time-select inputs A and B (see frequency select table). The output is available in either of two modes selectable via the MODE input, pin 10 (see truth table). When this MODE input is a logic "1", the output will be a continuous square wave having a frequency equal to the oscillator frequency divided by  $2^N$ . With the MODE input set to logic "0" and after a MASTER RESET is initiated, the output (assuming Q output has been selected) changes from a low to a high state after  $2^{N-1}$  counts and remains in that state until another MASTER RESET pulse is applied or the MODE input is set to a logic "1".

Timing is initialized by setting the AUTO RESET input (pin 5) to logic "0" and turning power on. If pin 5 is set to logic "1", the AUTO RESET circuit is disabled and counting will not start until after a positive MASTER RESET pulse is applied and returns to a low level. The AUTO RESET con-

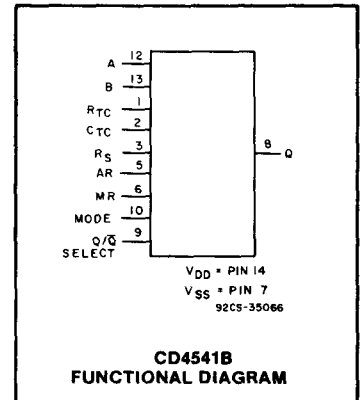

- Capable of driving six low power TTL loads, three low-power Schottky loads, or six HTL loads over the rated temperature range
- Symmetrical output characteristics
- 100% tested for quiescent current at 20 V
- 5-V, 10-V, and 15-V parametric ratings
- Meets all requirements of JEDEC Tentative Standard No. 13A, "Standard Specifications for Description of 'B' Series CMOS Devices"

sumes an appreciable amount of power and should not be used if low-power operation is desired.

The RC oscillator, shown in Fig. 2, oscillates with a frequency determined by the R-C network and is calculated using:

$$f = \frac{1}{2.3 R_{TC} C_{TC}} \quad \text{where } f \text{ is between } 1 \text{ kHz and } 100 \text{ kHz}$$

and  $R_S \geq 10 \text{ k}\Omega$  and  $\approx 2R_{TC}$

The CD4541B types are supplied in 14-lead hermetic dual-in-line ceramic packages (D and F suffixes), 14-lead dual-in-line plastic packages (E suffix), and in chip form (H suffix).

FREQUENCY SELECTION TABLE

A	B	No. of Stages N	Count $2^N$
0	0	13	8192
0	1	10	1024
1	0	8	256
1	1	16	65536

TRUTH TABLE

PIN	STATE	
	0	1
5	Auto Reset On	Auto Reset Disable
6	Master Reset Off	Master Reset On
9	Output Initially Low After Reset (Q)	Output Initially High After Reset (Q̄)
10	Single Transition Mode	Recycle Mode

# CD4541B Types

## MAXIMUM RATINGS, Absolute-Maximum Values:

DC SUPPLY-VOLTAGE RANGE, ( $V_{DD}$ )	-0.5 to +20 V
(Voltages referenced to $V_{SS}$ Terminal)	
INPUT VOLTAGE RANGE, ALL INPUTS	-0.5 to $V_{DD} + 0.5$ V
DC INPUT CURRENT, ANY ONE INPUT	$\pm 10$ mA
POWER DISSIPATION PER PACKAGE ( $P_D$ ):	
For $T_A = -40$ to $+60^\circ\text{C}$ (PACKAGE TYPE E)	500 mW
For $T_A = +60$ to $+85^\circ\text{C}$ (PACKAGE TYPE E)	Derate Linearly at 12 mW/ $^\circ\text{C}$ to 200 mW
For $T_A = -55$ to $+100^\circ\text{C}$ (PACKAGE TYPES D, F)	500 mW
For $T_A = +100$ to $+125^\circ\text{C}$ (PACKAGE TYPES D, F)	Derate Linearly at 12 mW/ $^\circ\text{C}$ to 200 mW
DEVICE DISSIPATION PER OUTPUT TRANSISTOR	
FOR $T_A =$ FULL PACKAGE-TEMPERATURE RANGE (All Package Types)	100 mW
OPERATING-TEMPERATURE RANGE ( $T_A$ ):	
PACKAGE TYPES D, F, H	-55 to $+125^\circ\text{C}$
PACKAGE TYPE E	-40 to $+85^\circ\text{C}$
STORAGE TEMPERATURE RANGE ( $T_{stg}$ )	-65 to $+150^\circ\text{C}$
LEAD TEMPERATURE (DURING SOLDERING):	
At distance $1/16 \pm 1/32$ inch ( $1.59 \pm 0.79$ mm) from case for 10 s max.	$+265^\circ\text{C}$

## RECOMMENDED OPERATING CONDITIONS

For maximum reliability, nominal operating conditions should be selected so that operation is always within the following ranges:

CHARACTERISTIC	$V_{DD}$ (V)	LIMITS		UNITS
		MIN.	TYP.	
Supply-Voltage Range (For $T_A =$ Full Package-Temperature Range)	—	3	18	V

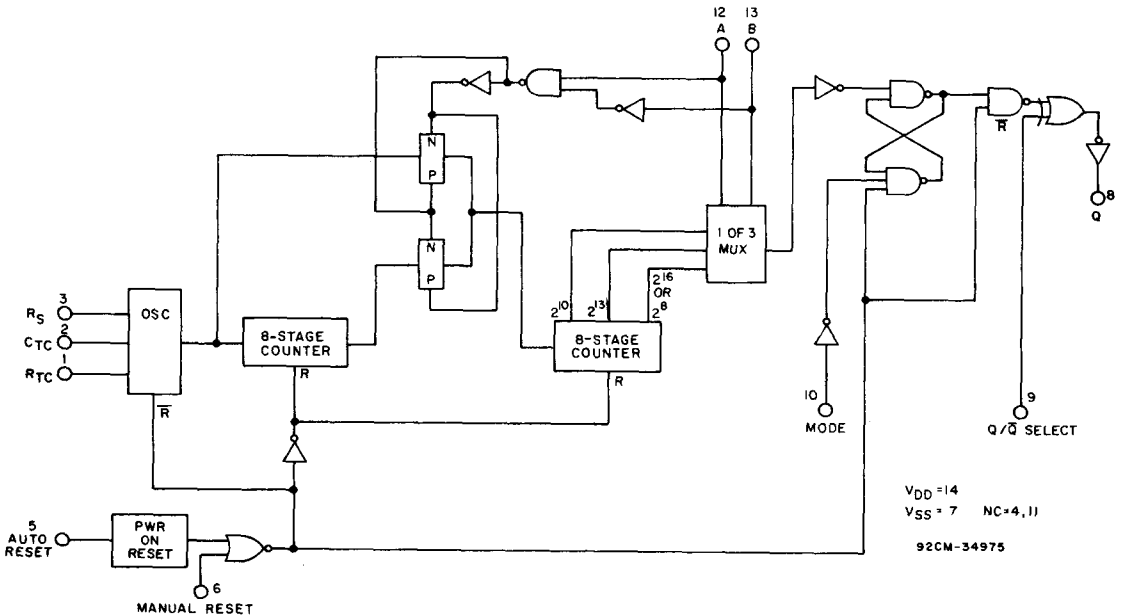
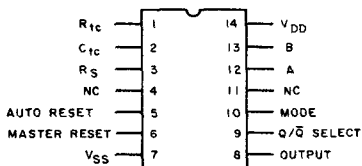

Fig. 1 — CD4541B functional diagram.

# CD4541B Types

## STATIC ELECTRICAL CHARACTERISTICS

CHARACTERISTIC	CONDITIONS			LIMITS AT INDICATED TEMPERATURES (°C)							UNITS
	V <sub>O</sub> (V)	V <sub>IN</sub> (V)	V <sub>DD</sub> (V)	Values at -55, +25, +125 Apply to D, F, H Packages				Values at -40, +25, +85 Apply to E Package			
				-55	-40	+85	+125	+25			
				MIN. TYP. MAX.							
Quiescent Device Current, I <sub>DD</sub> Max.	—	0,5	5	5	5	150	150	—	0.04	5	μA
	—	0,10	10	10	10	300	300	—	0.04	10	
	—	0,15	15	20	20	600	600	—	0.04	20	
Output Low (Sink) Current, I <sub>OL</sub> Min.	0.4	0,5	5	1.9	1.85	1.26	1.08	1.55	3.1	—	mA
	0.5	0,10	10	5	4.8	3.3	2.8	4	8	—	
	1.5	0,15	15	12.6	12	8.4	7.2	10	20	—	
Output High (Source) Current, I <sub>OH</sub> Min.	4.6	0,5	5	-1.9	-1.85	-1.26	-1.08	-1.55	-3.1	—	mA
	2.5	0,5	5	-6.2	-6	-4.1	-3	-5	-10	—	
	9.5	0,10	10	-5	-4.8	-3.3	-2.8	-4	-8	—	
Output Voltage: Low-Level, V <sub>OL</sub> Max.	—	0,5	5	—	—	0.05	—	—	0	0.05	V
	—	0,10	10	—	—	0.05	—	—	0	0.05	
	—	0,15	15	—	—	0.05	—	—	0	0.05	
Output Voltage: High-Level, V <sub>OH</sub> Min.	—	0,5	5	—	—	4.95	—	4.95	5	—	V
	—	0,10	10	—	—	9.95	—	9.95	10	—	
	—	0,15	15	—	—	14.95	—	14.95	15	—	
Input Low Voltage, V <sub>IL</sub> Max.	0.5, 4.5	—	5	—	—	1.5	—	—	—	1.5	V
	1,9	—	10	—	—	3	—	—	—	3	
	1.5, 13.5	—	15	—	—	4	—	—	—	4	
Input High Voltage, V <sub>IH</sub> Min.	0.5, 4.5	—	5	—	—	3.5	—	3.5	—	—	V
	1,9	—	10	—	—	7	—	7	—	—	
	1.5, 13.5	—	15	—	—	11	—	11	—	—	
Input Current, I <sub>IN</sub> Max.	—	0,18	18	±0.1	±0.1	±1	±1	—	±10 <sup>-5</sup>	±0.1	μA



92CS-34976

TERMINAL ASSIGNMENT

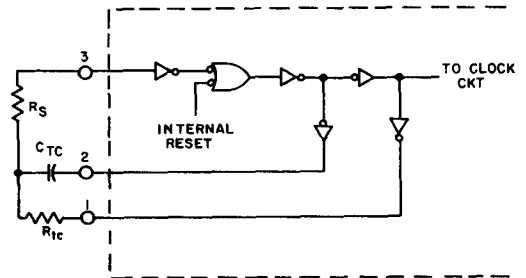

92CS-34977

Fig. 2 — RC oscillator circuit.



# CD4541B Types

DYNAMIC ELECTRICAL CHARACTERISTICS, at  $T_A = 25^\circ\text{C}$ , Input  $t_r, t_f = 20\text{ ns}$ ,  $C_L = 50\text{ pF}$ ,  $R_L = 200\text{ k}\Omega$

CHARACTERISTIC	$V_{DD}$ (V)	LIMITS			UNITS	
		MIN.	TYP.	MAX.		
Propagation Delay Times: Clock to Q	5	—	3.5	10.5	$\mu\text{s}$	
	10	—	1.25	3.8		
	15	—	0.9	2.9		
	$(2^8)$ $t_{PHL}, t_{PLH}$	5	—	6	18	$\mu\text{s}$
		10	—	3.5	10	
		15	—	2.5	7.5	
Transition Time,	$t_{THL}$	5	—	100	ns	
		10	—	50		
		15	—	40		
	$t_{TLH}$	5	—	180	ns	
		10	—	90		
		15	—	65		
MASTER RESET, CLOCK Pulse Width	5	900	300	—	ns	
	10	300	100	—		
	15	225	85	—		
Maximum Clock Pulse Input Frequency,	$f_{CL}$	5	—	1.5	MHz	
		10	—	4		
		15	—	6		
Maximum Clock Pulse Input Rise or Fall Time,	$t_r, t_f$	5,10,15	Unlimited		$\mu\text{s}$	

## DIGITAL TIMER APPLICATION

A positive pulse on MASTER RESET resets the counters and latch. The output goes high and remains high until the number of pulses, selected by A and B, are counted. This circuit is retriggerable and is as accurate as the input frequency. If additional accuracy is desired, an external clock can be used on pin 3. A set-up time equal to the width of the one-shot output is required immediately following initial power up, during which time the output will be high.

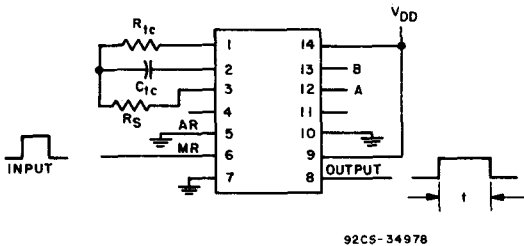
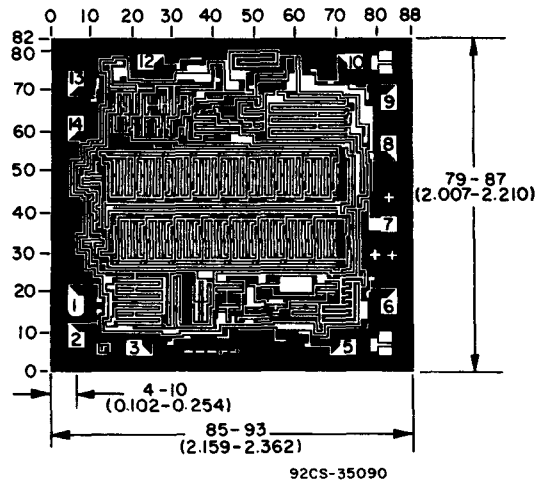

Fig. 3 - Digital timer application circuit.



Dimensions and pad layout for CD4541B.

Dimensions in parentheses are in millimeters and are derived from the basic inch dimensions as indicated. Grid graduations are in mils ( $10^{-3}$  inch).

The photographs and dimensions of each CMOS chip represent a chip when it is part of the wafer. When the wafer is separated into individual chips, the angle of cleavage may vary with respect to the chip face for different chips. The actual dimensions of the isolated chip, therefore, may differ slightly from the nominal dimensions shown. The user should consider a tolerance of  $-3$  mils to  $+16$  mils applicable to the nominal dimensions shown.

# CD4543B Types

## CMOS BCD-to-Seven-Segment Latch/Decoder/Driver For Liquid-Crystal Displays

High-Voltage Types (20-Volt Rating)

**Features:**

- Display blanking of all illegal input combinations
- Latch storage of code
- Capability of driving two low power TTL loads, two HTL loads, or one low power Schottky load over the full rated-temperature range
- Pin-for-pin replacement for the CD4056B (with pin 7 tied to V<sub>SS</sub>)
- Direct LED driving capability

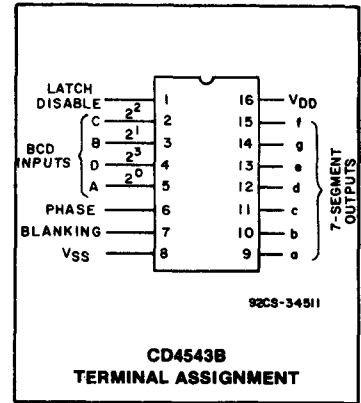

The RCA-CD4543B is a BCD-to-seven segment latch/decoder/driver designed primarily for liquid-crystal display (LCD) applications. It is also capable of driving light emitting diode (LED), incandescent, gas-discharge, and fluorescent displays. This device is functionally similar to and serves as direct replacement for the CD4056B when pin 7 is connected to V<sub>SS</sub>. It differs from the CD4056B in that it has a display blanking capability instead of a level-shifting function and requires only one power supply. When the CD4056B is used in the level shifting mode, two power supplies are required. When the CD4543B is used for LCD applications, a square wave must be applied to the PHASE input and the backplane of the LCD device. For LED applications a logic 1 is required at the PHASE input for common-cathode devices; a logic 0 is required for common-anode devices (see truth table).

The CD4543B is supplied in hermetic dual-in-line ceramic packages (D and F suffixes), 16-lead dual-in-line plastic packages (E suffix), 16-lead ceramic flat packages (K suffix), and in chip form (H suffix).

- 100% tested for quiescent current at 20 V
- Maximum input current of 1 μA at 18 V over full package-temperature range; 100 nA at 18 V and 25°C
- Noise margin (full package-temperature range) = 1 V at V<sub>DD</sub>=5 V  
2 V at V<sub>DD</sub>=10 V  
2.5 V at V<sub>DD</sub>=15 V
- 5-V, 10-V, and 15-V parametric ratings
- Meets all requirements of JEDEC Tentative Standard No. 13B, "Standard Specifications for Description of 'B' Series CMOS Devices"

**Applications:**

- Instrument display driver
- Dashboard display driver
- Computer/calculator display driver
- Timing device driver (clocks, watches, timers)

**MAXIMUM RATINGS, Absolute-Maximum Values:**

DC SUPPLY-VOLTAGE RANGE, (V <sub>DD</sub> ) (Voltages referenced to V <sub>SS</sub> Terminal)	-0.5 to +20 V
INPUT VOLTAGE RANGE, ALL INPUTS	-0.5 to V <sub>DD</sub> +0.5 V
DC INPUT CURRENT, ANY ONE INPUT	±10 mA
POWER DISSIPATION PER PACKAGE (P <sub>D</sub> ):	
For T <sub>A</sub> = -40 to +60°C (PACKAGE TYPE E)	500 mW
For T <sub>A</sub> = +60 to +85°C (PACKAGE TYPE E)	Derate Linearly at 12 mW/°C to 200 mW
For T <sub>A</sub> = -55 to +100°C (PACKAGE TYPES D, F, K)	500 mW
For T <sub>A</sub> = +100 to +125°C (PACKAGE TYPES D, F, K)	Derate Linearly at 12 mW/°C to 200 mW
DEVICE DISSIPATION PER OUTPUT TRANSISTOR:	
For T <sub>A</sub> = FULL PACKAGE-TEMPERATURE RANGE (All Package Types)	100 mW
OPERATING-TEMPERATURE RANGE (T <sub>A</sub> ):	
PACKAGE TYPES D, F, K, H	-55 to +125°C
PACKAGE TYPE E	-40 to +85°C
STORAGE TEMPERATURE RANGE (T <sub>stg</sub> )	-65 to +150°C
LEAD TEMPERATURE (DURING SOLDERING):	
At distance 1/16 ± 1/32 inch (1.59 ± 0.79 mm) from case for 10 s max.	+265°C

# CD4543B Types

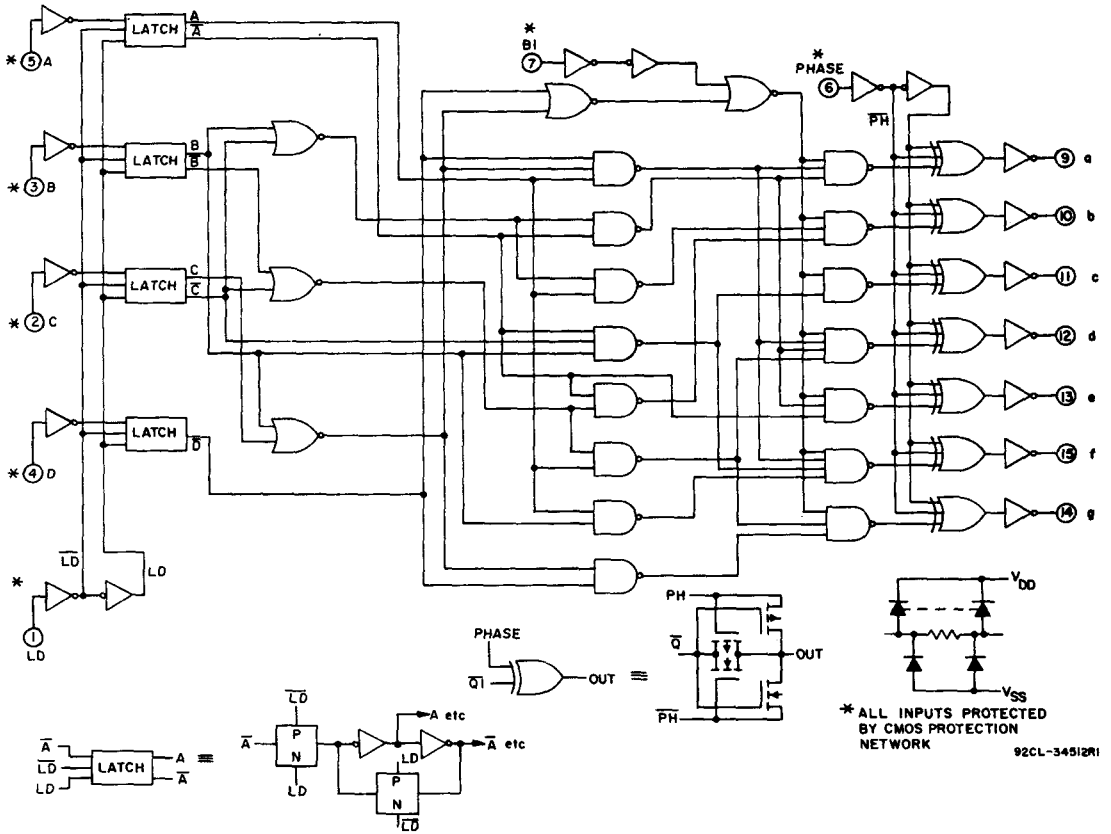

Fig. 1 - BCD-to-seven-segment latch/decoder/driver CD4543B logic circuit diagram.

## RECOMMENDED OPERATING CONDITIONS at $T_A=25^\circ\text{C}$ , Unless Otherwise Specified

For maximum reliability, nominal operating conditions should be selected so that operation is always within the following ranges:

CHARACTERISTIC	$V_{DD}$ (V)	LIMITS		UNITS
		MIN.	TYP.	
Supply-Voltage Range (For $T_A$ =Full Package-Temperature Range)	—	3	18	V
Latch Disable Pulse Width	5	250	125	ns
	10	100	50	
	15	80	40	
Minimum Data Setup Time	5	60	15	
	10	20	-5	
	15	10	-5	
Minimum Data Hold Time	5	25	-5	
	10	20	10	
	15	20	10	

# CD4543B Types

## STATIC ELECTRICAL CHARACTERISTICS

CHARACTERISTIC	CONDITIONS			LIMITS AT INDICATED TEMPERATURES (°C)							UNITS	
	V <sub>O</sub> (V)	V <sub>IN</sub> (V)	V <sub>DD</sub> (V)	Values at -55, +25, +125 Apply to D, F, K, H Packages				Values at -40, +25, +85 Apply to E Package				
				-55	-40	+85	+125	+25				
								Min.	Typ.	Max.		
Quiescent Device Current Max.	I <sub>DD</sub>	—	0, 5	5	5	150	150	—	0.04	5	μA	
		—	0,10	10	10	300	300	—	0.04	10		
		—	0,15	15	20	600	600	—	0.04	20		
		—	0,20	20	100	100	3000	3000	—	0.08		100
Output Low (Sink) Current Min.	I <sub>OL</sub>	0.4	0, 5	5	0.64	0.61	0.42	0.36	0.51	1	—	mA
		0.5	0,10	10	1.6	1.5	1.1	0.9	1.3	2.6	—	
		1.5	0,15	15	4.2	4	2.8	2.4	3.4	6.8	—	
Output High (Source) Current Min.	I <sub>OH</sub>	4.6	0, 5	5	-0.46	-0.44	-0.30	-0.26	-0.37	-0.75	—	mA
		2.5	0, 5	5	-1.6	-1.5	-1.1	-0.9	-1.3	-2.6	—	
		9.5	0,10	10	-0.98	-0.92	-0.68	-0.55	-0.8	-1.6	—	
		13.5	0,15	15	-3.33	-3.18	-2.2	-1.9	-2.7	-5.4	—	
Output Voltage: Low-Level Max.	V <sub>OL</sub>	—	0, 5	5	0.05			—	0	0.05	V	
		—	0,10	10	0.05			—	0	0.05		
		—	0,15	15	0.05			—	0	0.05		
Output Voltage: High-Level Min.	V <sub>OH</sub>	—	0, 5	5	4.95			4.95	5	—	V	
		—	0,10	10	9.95			9.95	10	—		
		—	0,15	15	14.95			14.95	15	—		
Input Low Voltage Max.	V <sub>IL</sub>	0.5,4,5	—	5	1.5			—	—	1.5	V	
		1, 9	—	10	3			—	—	3		
		1.5,13.5	—	15	4			—	—	4		
Input High Voltage Min.	V <sub>IH</sub>	0.5,4,5	—	5	3.5			3.5	—	—	V	
		1, 9	—	10	7			7	—	—		
		1.5,13.5	—	15	11			11	—	—		
Input Current Max.	I <sub>IN</sub>	—	0,18	18	±0.1	±0.1	±1	±1	—	±10 <sup>-5</sup>	±0.1	μA

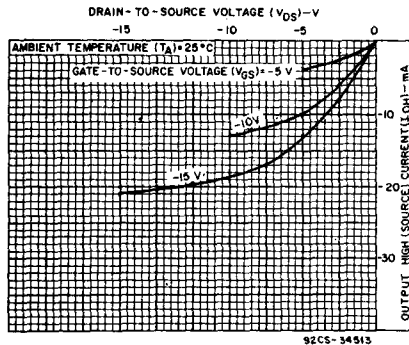

Fig. 2 - Typical output high (source) current characteristics.

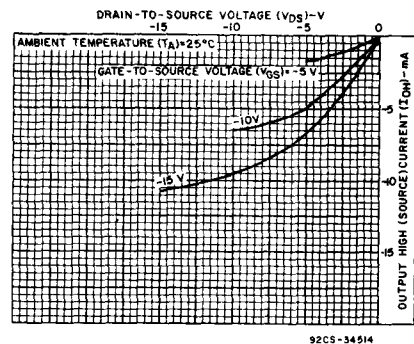

Fig. 3 - Minimum output high (source) current characteristics.

# CD4543B Types

DYNAMIC ELECTRICAL CHARACTERISTICS at  $T_A=25^\circ\text{C}$ ;  $C_L=50\text{ pF}$ , Input  $t_r, t_f=20\text{ ns}$ ,  $R_L=200\text{ k}\Omega$

CHARACTERISTIC	TEST CONDITIONS $V_{DD}$ (V)	LIMITS All Packages			UNITS	
		MIN.	TYP.	MAX.		
Propagation Delay Time	$t_{PHL}$	5	—	600	ns	
		10	—	200		
		15	—	150		
	$t_{PLH}$	5	—	500		
		10	—	200		
		15	—	150		
Transition Time	$t_{THL}$	5	—	180		
		10	—	90		
		15	—	65		
	$t_{TLH}$	5	—	180		
		10	—	90		
		15	—	65		
Latch Disable Pulse Width	$t_{WH}$	5	250	125	—	
		10	100	50	—	
		15	80	40	—	
Address Setup Time	$t_{SU}$	5	60	15	—	
		10	20	-5	—	
		15	10	-5	—	
Address Hold Time	$t_H$	5	25	-5	—	
		10	20	10	—	
		15	20	10	—	
Input Capacitance	$C_{IN}$	Any Input	—	5	7.5	pF

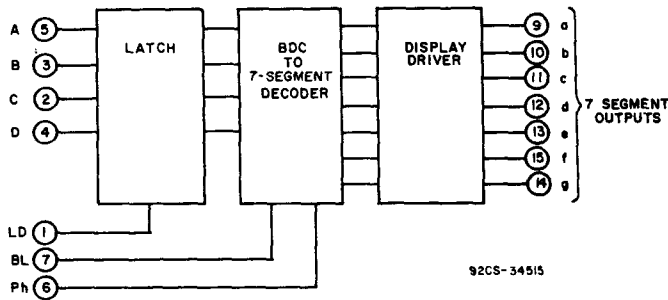

Fig. 4 - BCD-to-seven-segment latch/decoder/driver functional diagram.

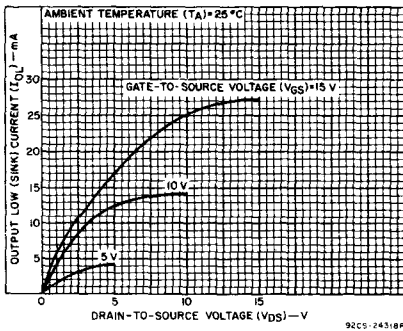

Fig. 5 - Typical output low (sink) current characteristics.

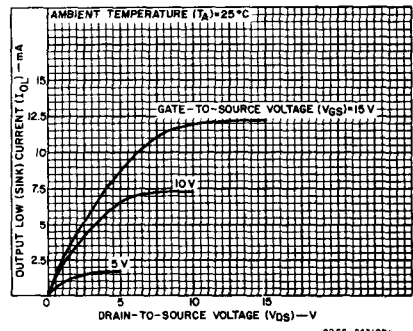

Fig. 6 - Minimum output low (sink) current characteristics.

# CD4543B Types

TRUTH TABLE FOR CD4543B

INPUT CODE							OUTPUT STATE							DISPLAY CHARACTER
LD	BI	Ph*	D	C	B	A	a	b	c	d	e	f	g	
X	1	0	X	X	X	X	0	0	0	0	0	0	0	
1	0	0	0	0	0	0	1	1	1	1	1	1	0	
1	0	0	0	0	0	1	0	1	1	0	0	0	0	
1	0	0	0	0	1	0	1	1	0	1	1	0	1	
1	0	0	0	0	1	1	1	1	1	1	0	0	1	
1	0	0	0	1	0	0	0	1	1	0	0	1	1	
1	0	0	0	1	0	1	1	0	1	1	0	1	1	
1	0	0	0	1	1	1	1	1	1	0	0	0	0	
1	0	0	1	0	0	0	1	1	1	1	1	1	1	
1	0	0	1	0	0	1	1	1	1	1	0	1	1	
1	0	0	1	0	1	0	0	0	0	0	0	0	0	
1	0	0	1	0	1	1	0	0	0	0	0	0	0	
1	0	0	1	1	0	0	0	0	0	0	0	0	0	
1	0	0	1	1	0	1	0	0	0	0	0	0	0	
1	0	0	1	1	1	0	0	0	0	0	0	0	0	
1	0	0	1	1	1	1	0	0	0	0	0	0	0	
0	0	0	X	X	X	X	**							**
†	†	1	†				Inverse of Output Combinations Above							Display as above

X=Don't care.

†=Above combinations.

\*=For liquid-crystal readouts, apply a square wave to Ph.

For common cathode LED readouts, select Ph=0.

For common anode LED readouts, select Ph=1.

\*\*=Depends upon the BCD code previously applied when LD=1.

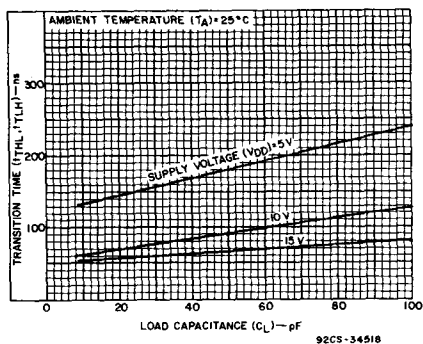

Fig. 7 - Typical transition time as a function of load capacitance.

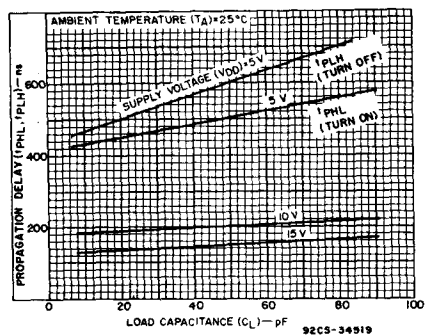

Fig. 8 - Typical propagation delay time as a function of load capacitance.

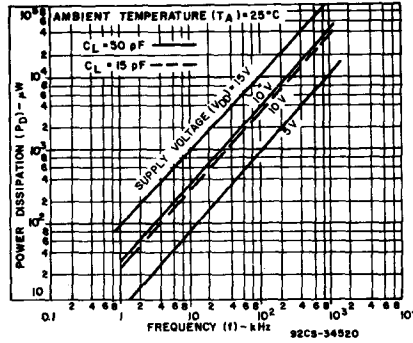

Fig. 9 - Typical dynamic power dissipation as a function of frequency.

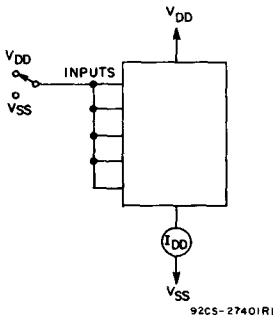

Fig. 10 - Quiescent device current test circuit.

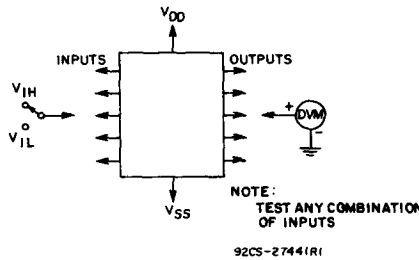

Fig. 11 - Input voltage test circuit.

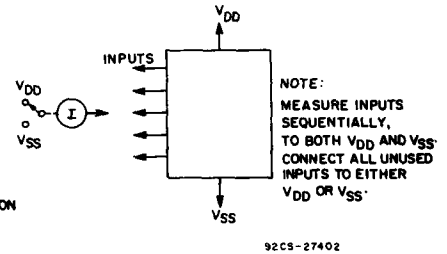
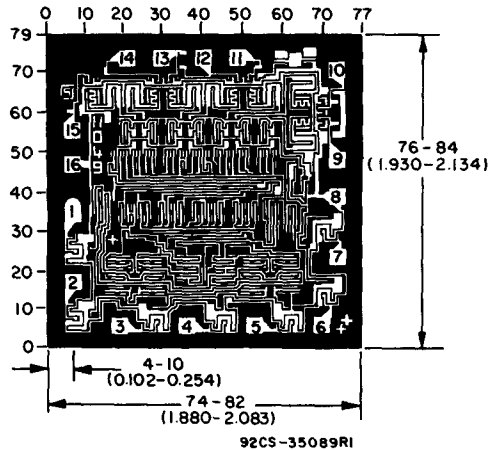

Fig. 12 - Input current test circuit.



Dimensions and pad layout for CD4543BH.

Dimensions in parentheses are in millimeters and are derived from the basic inch dimensions as indicated. Grid graduations are in mils ( $10^{-3}$  inch).

The photographs and dimensions of each CMOS chip represent a chip when it is part of the wafer. When the wafer is separated into individual chips, the angle of cleavage may vary with respect to the chip face for different chips. The actual dimensions of the isolated chip, therefore, may differ slightly from the nominal dimensions shown. The user should consider a tolerance of -3 mils to +16 mils applicable to the nominal dimensions shown.

# CD4555B, CD4556B Types

## CMOS Dual Binary to 1 of 4 Decoder/Demultiplexers

High-Voltage Types (20-Volt Rating)

**CD4555B: Outputs High on Select**  
**CD4556B: Outputs Low on Select**

The RCA-CD4555B and CD4556B are dual one-of-four decoders/demultiplexers. Each decoder has two select inputs (A and B), an Enable input ( $\bar{E}$ ), and four mutually exclusive outputs. On the CD4555B the outputs are high on select; on the CD4556B the outputs are low on select.

When the Enable input is high, the outputs of the CD4555B remain low and the outputs of the CD4556B remain high regardless of the state of the select inputs A and B. The CD4555B and CD4556B are similar to types MC14555 and MC14556, respectively.

The CD4555B and CD4556B types are supplied in 16-lead hermetic dual-in-line ceramic packages (D and F suffixes), 16-lead dual-in-line plastic packages (E suffix), 16-lead ceramic flat packages (K suffix), and in chip form (H suffix).

### Features:

- Expandable with multiple packages
- Standard, symmetrical output characteristics
- 100% tested for quiescent current at 20 V
- Maximum input current of 1  $\mu$ A at 18 V over full package temperature range; 100 nA at 18 V and 25°C
- Noise margin (full package-temperature range): 1 V at  $V_{DD} = 5$  V  
2 V at  $V_{DD} = 10$  V  
2.5 V at  $V_{DD} = 15$  V
- 5-V, 10-V, and 15-V parametric ratings
- Meets all requirements of JEDEC Tentative Standard No. 13A, "Standard Specifications for Description of 'B' Series CMOS Devices"

### Applications:

- Decoding
- Code conversion
- Demultiplexing (using Enable input as a data input)
- Memory chip-enable selection
- Function selection

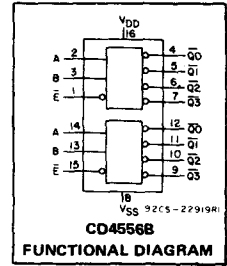
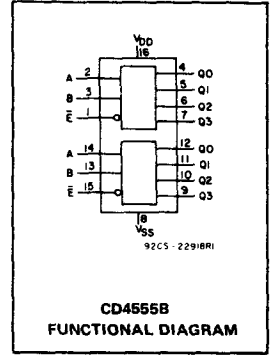

### RECOMMENDED OPERATING CONDITIONS

For maximum reliability, nominal operating conditions should be selected so that operation is always within the following ranges.

CHARACTERISTIC	$V_{DD}$	MIN.	MAX.	UNITS
Supply Voltage Range (For $T_A$ = Full Package Temp. Range)	—	3	18	V

### MAXIMUM RATINGS, Absolute-Maximum Values:

DC SUPPLY-VOLTAGE RANGE, ( $V_{DD}$ ) (Voltages referenced to $V_{SS}$ Terminal)	-0.5 to +20 V
INPUT VOLTAGE RANGE, ALL INPUTS	-0.5 to $V_{DD} + 0.5$ V
DC INPUT CURRENT, ANY ONE INPUT	$\pm 10$ mA
POWER DISSIPATION PER PACKAGE ( $P_D$ ):	
For $T_A = -40$ to $+60^\circ\text{C}$ (PACKAGE TYPE E)	500 mW
For $T_A = +60$ to $+85^\circ\text{C}$ (PACKAGE TYPE E)	Derate Linearly at 12 mW/ $^\circ\text{C}$ to 200 mW
For $T_A = -55$ to $+100^\circ\text{C}$ (PACKAGE TYPES D, F, K)	500 mW
For $T_A = +100$ to $+125^\circ\text{C}$ (PACKAGE TYPES D, F, K)	Derate Linearly at 12 mW/ $^\circ\text{C}$ to 200 mW
DEVICE DISSIPATION PER OUTPUT TRANSISTOR FOR $T_A$ = FULL PACKAGE-TEMPERATURE RANGE (All Package Types)	100 mW
OPERATING-TEMPERATURE RANGE ( $T_A$ ):	
PACKAGE TYPES D, F, K, H	-55 to $+125^\circ\text{C}$
PACKAGE TYPE E	-40 to $+85^\circ\text{C}$
STORAGE TEMPERATURE RANGE ( $T_{stg}$ )	-65 to $+150^\circ\text{C}$
LEAD TEMPERATURE (DURING SOLDERING):	
At distance 1/16 $\pm$ 1/32 inch (1.59 $\pm$ 0.79 mm) from case for 10 s max.	+265°C

### TERMINAL ASSIGNMENTS

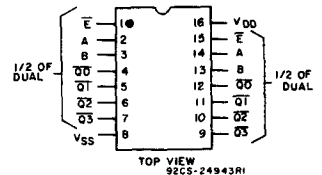

CD4556B

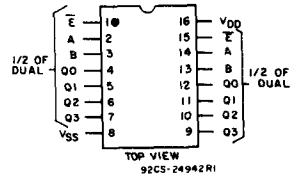

CD4555B



# CD4555B, CD4556B Types

## STATIC ELECTRICAL CHARACTERISTICS

CHARACTERISTIC	CONDITIONS			LIMITS AT INDICATED TEMPERATURES (°C)							UNITS		
	V <sub>O</sub> (V)	V <sub>IN</sub> (V)	V <sub>DD</sub> (V)	-55			+25			+125			
				Min.	Typ.	Max.	Min.	Typ.	Max.	Min.		Typ.	Max.
Quiescent Device Current, I <sub>DD</sub> Max.	-	0,5	5	5	5	5	150	150	-	0,04	5	μA	
	-	0,10	10	10	10	10	300	300	-	0,04	10		
	-	0,15	15	20	20	20	600	600	-	0,04	20		
	-	0,20	20	100	100	3000	3000	-	0,08	100			
Output Low (Sink) Current I <sub>OL</sub> Min.	0,4	0,5	5	0,64	0,61	0,42	0,36	0,51	1	-	mA		
	0,5	0,10	10	1,6	1,5	1,1	0,9	1,3	2,6	-			
	1,5	0,15	15	4,2	4	2,8	2,4	3,4	6,8	-			
Output High (Source) Current, I <sub>OH</sub> Min.	4,6	0,5	5	-0,64	-0,61	-0,42	-0,36	-0,51	-1	-	mA		
	2,5	0,5	5	-2	-1,8	-1,3	-1,15	-1,6	-3,2	-			
	9,5	0,10	10	-1,6	-1,5	-1,1	-0,9	-1,3	-2,6	-			
Output Voltage: Low-Level, V <sub>OL</sub> Max.	-	0,5	5			0,05			0	0,05	V		
	-	0,10	10			0,05			0	0,05			
	-	0,15	15			0,05			0	0,05			
Output Voltage: High-Level, V <sub>OH</sub> Min.	-	0,5	5			4,95			4,95	5	V		
	-	0,10	10			9,95			9,95	10			
	-	0,15	15			14,95			14,95	15			
Input Low Voltage, V <sub>IL</sub> Max.	0,5,4,5	-	5			1,5			-	1,5	V		
	1,9	-	10			3			-	3			
	1,5,13,5	-	15			4			-	4			
Input High Voltage, V <sub>IH</sub> Min.	0,5,4,5	-	5			3,5			3,5	-	V		
	1,9	-	10			7			7	-			
	1,5,13,5	-	15			11			11	-			
Input Current I <sub>IN</sub> Max.		0,18	18	±0,1	±0,1	±1	±1	-	±10 <sup>-5</sup>	±0,1	μA		

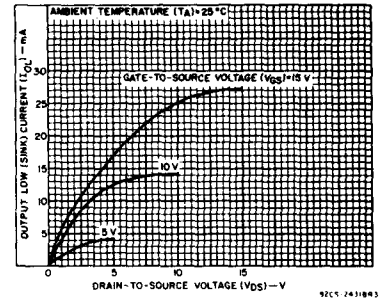

Fig. 1 - Typical output low (sink) current characteristics.

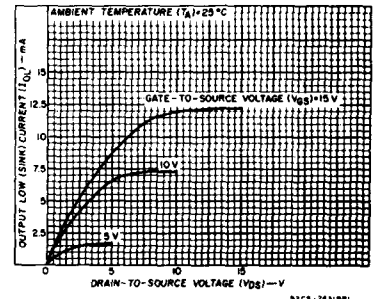

Fig. 2 - Minimum output low (sink) current characteristics.

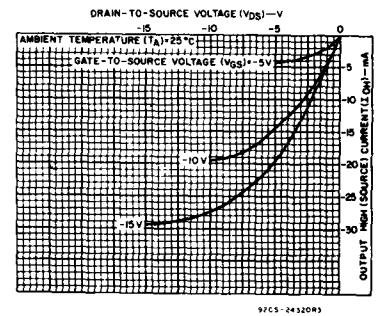

Fig. 3 - Typical output high (source) current characteristics.

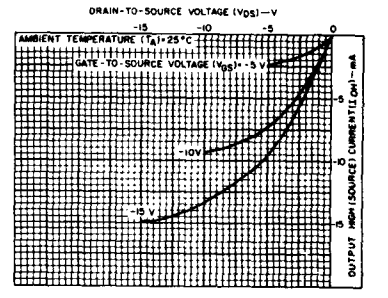
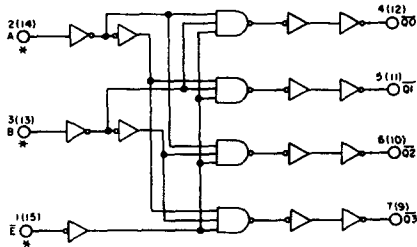

Fig. 4 - Minimum output high (source) current characteristics.

DYNAMIC ELECTRICAL CHARACTERISTICS at  $T_A = 25^\circ\text{C}$ ; Input  $t_r, t_f = 20\text{ ns}$ ,  $C_L = 50\text{ pF}$ ,  $R_L = 200\text{ K}\Omega$

CHARACTERISTIC	TEST CONDITIONS	ALL TYPES LIMITS		UNITS	
		V <sub>DD</sub> Volts	TYP.		MAX.
Propagation Delay Time, t <sub>PHL</sub> , A or B Input to Any Output	t <sub>PLH</sub>	5	220	440	ns
		10	95	190	
		15	70	140	
E Input to Any Output		5	200	400	ns
		10	85	170	
		15	65	130	
Transition Time t <sub>THL</sub> , t <sub>TLH</sub>		5	100	200	ns
		10	50	100	
		15	40	80	
Input Capacitance C <sub>IN</sub>	Any Input		5	7.5	pF

# CD4555B, CD4556B Types



\* ALL INPUTS PROTECTED BY COS/MOS PROTECTION NETWORK:

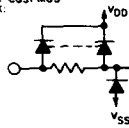

92CS-24222R1

Fig. 5 - CD4556B logic diagram (1 of 2 identical circuits).

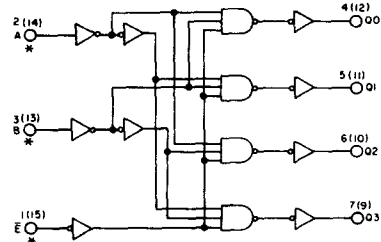

\* ALL INPUTS PROTECTED BY COS/MOS PROTECTION NETWORK:

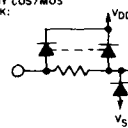

92CS-24221R1

Fig. 6 - CD4555B logic diagram (1 of 2 identical circuits).

## TRUTH TABLE

INPUTS			OUTPUTS CD4556B				OUTPUTS CD4555B			
$\bar{E}$	B	A	Q3	Q2	Q1	Q0	$\bar{Q}3$	$\bar{Q}2$	$\bar{Q}1$	$\bar{Q}0$
0	0	0	0	0	0	1	1	1	1	0
0	0	1	0	0	1	0	1	1	0	1
0	1	0	0	1	0	0	1	0	1	1
0	1	1	1	0	0	0	0	1	1	1
1	X	X	0	0	0	0	1	1	1	1

X = DON'T CARE

LOGIC 1  $\equiv$  HIGH  
LOGIC 0  $\equiv$  LOW

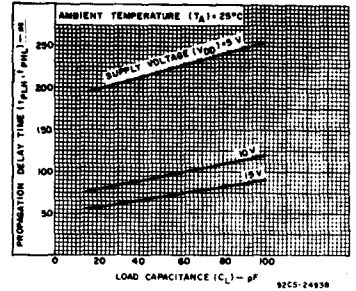

Fig. 7 - Typical propagation delay time vs. load capacitance (A or B input to any output).

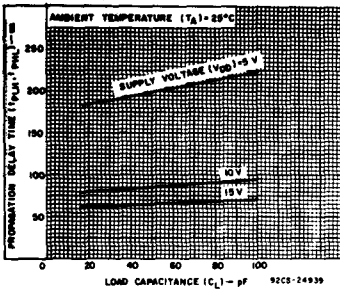

Fig. 8 - Typical propagation delay time vs. load capacitance (E input to any output).

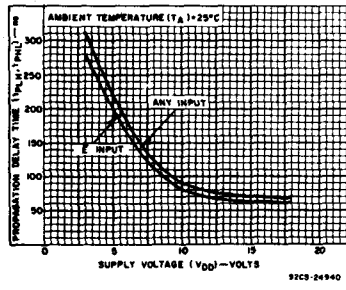

Fig. 9 - Typical propagation delay time vs. supply voltage.

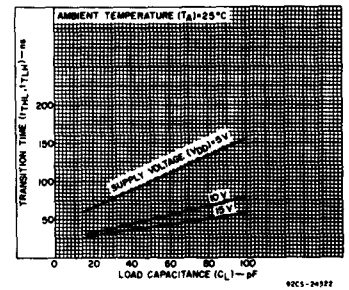

Fig. 10 - Typical transition time vs. load capacitance.

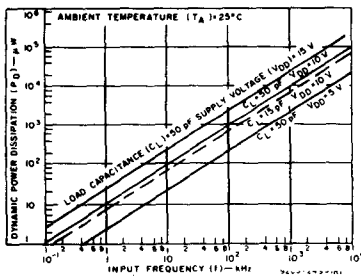

Fig. 11 - Typical dynamic power dissipation vs. frequency.

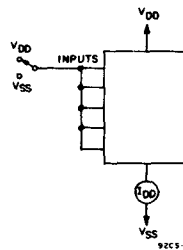

Fig. 12 - Quiescent device current test circuit.

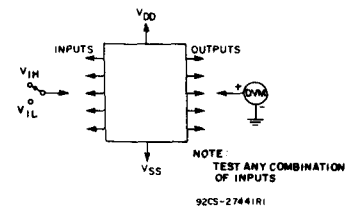

Fig. 13 - Input voltage test circuit.

# CD4555B, CD4556B Types

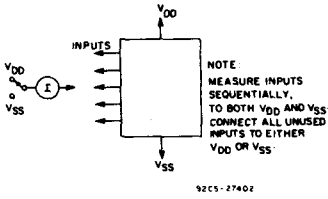

Fig. 14 - Input current test circuit.

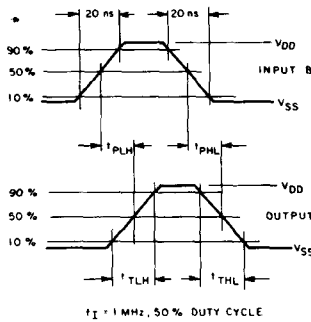

Fig. 15 - CD4555B B input to Q3 output dynamic signal waveforms.

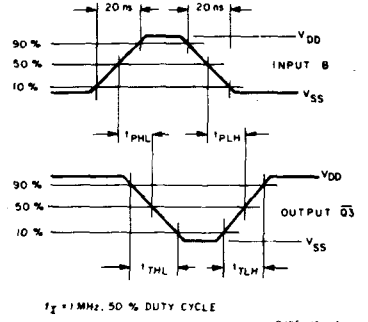

Fig. 16 - CD4555B B input to Q3 output dynamic signal waveforms.

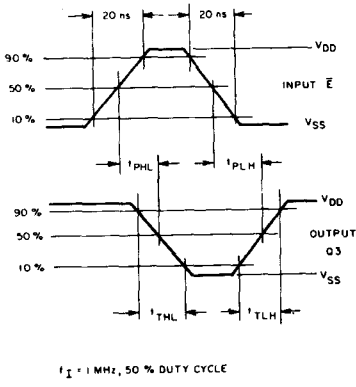

Fig. 17 - CD4555B E-bar input to Q3 output dynamic signal waveforms.

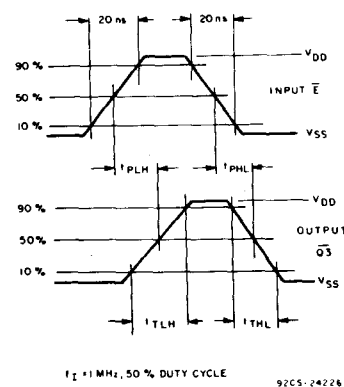
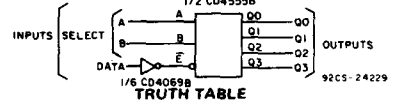

Fig. 18 - CD4555B E-bar input to Q3 output dynamic signal waveforms.

## APPLICATIONS



TRUTH TABLE

SELECT INPUTS		OUTPUTS			
B	A	Q0	Q1	Q2	Q3
0	0	DATA	0	0	0
0	1	0	DATA	0	0
1	0	0	0	DATA	0
1	1	0	0	0	DATA

Fig. 19 - 1-of-4 line data demultiplexer using CD4555B.

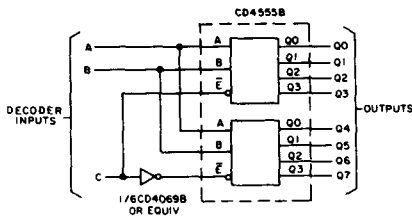

Fig. 20 - 1-of-8 decoder using CD4555B.

TRUTH TABLE

INPUTS			Q OUTPUTS							
C	B	A	0	1	2	3	4	5	6	7
0	0	0	1	0	0	0	0	0	0	0
0	0	1	0	1	0	0	0	0	0	0
0	1	0	0	0	1	0	0	0	0	0
0	1	1	0	0	0	0	1	0	0	0
1	0	0	0	0	0	0	1	0	0	0
1	0	1	0	0	0	0	0	1	0	0
1	1	0	0	0	0	0	0	0	1	0
1	1	1	0	0	0	0	0	0	0	1



# CMOS 4-Bit Magnitude Comparator

## High Voltage Types (20-Volt Rating)

The RCA-CD4585B is a 4-bit magnitude comparator designed for use in computer and logic applications that require the comparison of two 4-bit words. This logic circuit determines whether one 4-bit word (Binary or BCD) is "less than", "equal to", or "greater than" a second 4-bit word.

The CD4585B has eight comparing inputs (A3, B3, through A0, B0), three outputs (A < B, A = B, A > B) and three cascading inputs (A < B, A = B, A > B) that permit systems designers to expand the comparator function to 8, 12, 16.....4N bits. When a single CD4585B is used, the cascading inputs are connected as follows: (A < B) = low, (A = B) = high, (A > B) = high.

Cascading these units for comparison of more than 4 bits is accomplished as shown in Fig. 13.

The CD4585B types are supplied in 16-lead hermetic dual-in-line ceramic packages (D and F suffixes), 16-lead dual-in-line plastic packages (E suffix), 16-lead ceramic flat packages (K suffix), and in chip form (H suffix). This device is pin-compatible with low-power TTL type 7485 and the CMOS types MC14585 and 40085.

### Features:

- Expansion to 8,12,16.....4N bits by cascading units
- Medium-speed operation:  
compares two 4-bit words  
in 180 ns (typ.) at 10 V
- 100% tested for quiescent current at 20 V
- Standardized symmetrical output characteristics
- 5-V, 10-V, and 15-V parametric ratings
- Maximum input current of 1 μA at 18 V over full package temperature range; 100 nA at 18 V and 25°C
- Noise margin (full package temperature range) = 1 V at V<sub>DD</sub> = 5 V  
2 V at V<sub>DD</sub> = 10 V  
2.5 V at V<sub>DD</sub> = 15 V
- Meets all requirements of JEDEC Tentative Standard No. 13A, "Standard Specifications for Description of 'B' Series CMOS Devices"

### Applications:

- Servo motor controls
- Process controllers

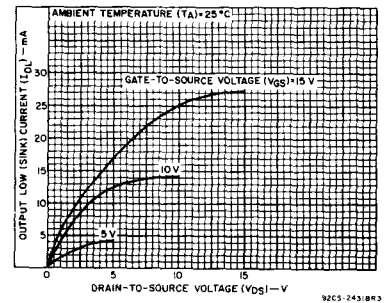
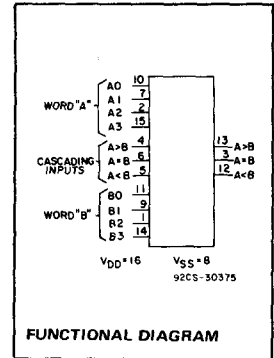

Fig.1 - Typical output low (sink) current characteristics.

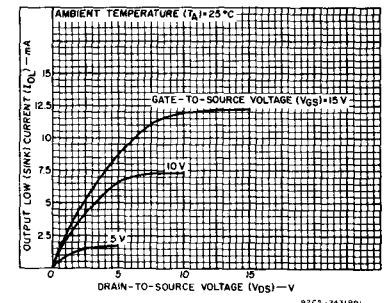

Fig.2 - Minimum output low (sink) current characteristics.

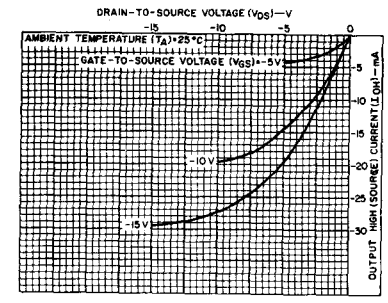

Fig.3 - Typical output high (source) current characteristics.

### MAXIMUM RATINGS, Absolute-Maximum Values:

DC SUPPLY-VOLTAGE RANGE, (V <sub>DD</sub> ) (Voltages referenced to V <sub>SS</sub> Terminal)	-0.5 to +20 V
INPUT VOLTAGE RANGE, ALL INPUTS	-0.5 to V <sub>DD</sub> + 0.5 V
DC INPUT CURRENT, ANY ONE INPUT	±10 mA
POWER DISSIPATION PER PACKAGE (P <sub>D</sub> ):	
For T <sub>A</sub> = -40 to +60°C (PACKAGE TYPE E)	500 mW
For T <sub>A</sub> = +60 to +85°C (PACKAGE TYPE E)	Derate Linearly at 12 mW/°C to 200 mW
For T <sub>A</sub> = -55 to +100°C (PACKAGE TYPES D, F, K)	500 mW
For T <sub>A</sub> = +100 to +125°C (PACKAGE TYPES D, F, K)	Derate Linearly at 12 mW/°C to 200 mW
DEVICE DISSIPATION PER OUTPUT TRANSISTOR	
FOR T <sub>A</sub> = FULL PACKAGE-TEMPERATURE RANGE (All Package Types)	100 mW
OPERATING-TEMPERATURE RANGE (T <sub>A</sub> ):	
PACKAGE TYPES D, F, K, H)	-55 to +125°C
PACKAGE TYPE E	-40 to +85°C
STORAGE TEMPERATURE RANGE (T <sub>stg</sub> )	-65 to +150°C
LEAD TEMPERATURE (DURING SOLDERING):	
At distance 1/16 ± 1/32 inch (1.59 ± 0.79 mm) from case for 10 s max.	+265°C

### RECOMMENDED OPERATING CONDITIONS

For maximum reliability, nominal operating conditions should be selected so that operation is always within the following ranges:

CHARACTERISTIC	LIMITS		UNITS
	Min.	Max.	
Supply-Voltage Range (For T <sub>A</sub> = Full Package-Temperature Range)	3	18	V

# CD4585B Types

TRUTH TABLE

INPUTS							OUTPUTS		
COMPARING			CASCADING				A < B	A = B	A > B
A3, B3	A2, B2	A1, B1	A0, B0	A < B	A = B	A > B	A < B	A = B	A > B
A3 > B3	X	X	X	X	X	1	0	0	1
A3 = B3	A2 > B2	X	X	X	X	1	0	0	1
A3 = B3	A2 = B2	A1 > B1	X	X	X	1	0	0	1
A3 = B3	A2 = B2	A1 = B1	A0 > B0	X	X	1	0	0	1
A3 = B3	A2 = B2	A1 = B1	A0 = B0	0	0	1	0	0	1
A3 = B3	A2 = B2	A1 = B1	A0 = B0	0	1	X	0	1	0
A3 = B3	A2 = B2	A1 = B1	A0 = B0	1	0	X	1	0	0
A3 = B3	A2 = B2	A1 = B1	A0 < B0	X	X	X	1	0	0
A3 = B3	A2 = B2	A1 < B1	X	X	X	X	1	0	0
A3 = B3	A2 < B2	X	X	X	X	X	1	0	0
A3 < B3	X	X	X	X	X	X	1	0	0

X = Don't Care

Logic 1 = High Level

Logic 0 = Low Level

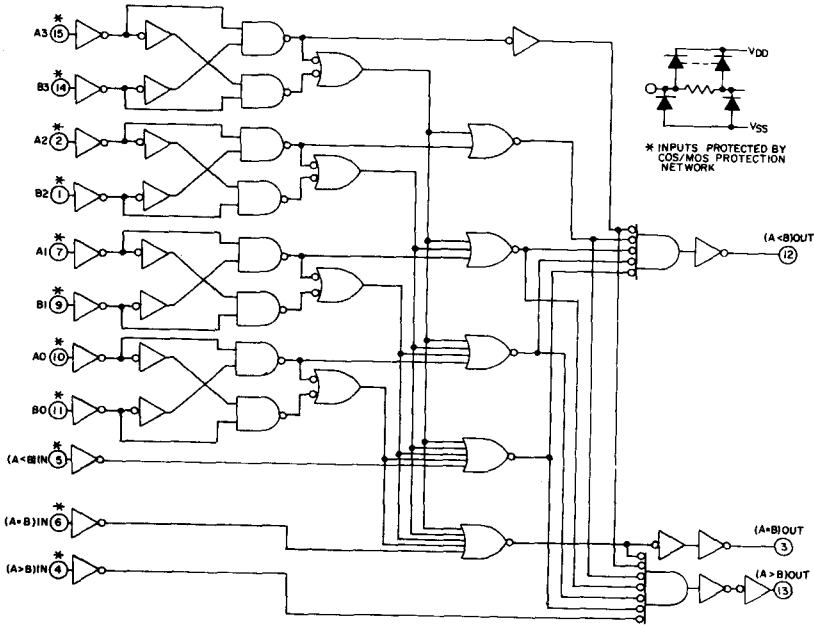

Fig. 4 - Logic diagram.

92CL-31008

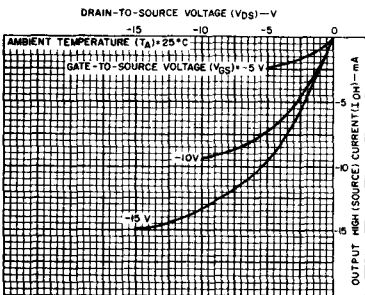

Fig. 5 - Minimum output high (source) current characteristics.

92CS-24321R2

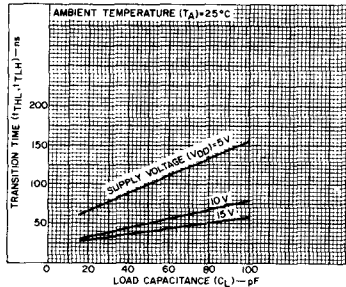

Fig. 6 - Typical transition time as a function of load capacitance.

92CS-24322

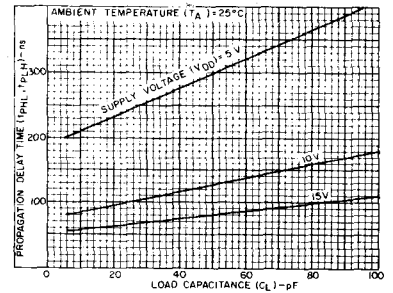

Fig. 7 - Typical propagation delay time ("comparing inputs" to outputs) as a function of load capacitance.

92CS-32066

# CD4585B Types

## STATIC ELECTRICAL CHARACTERISTICS

CHARACTERISTIC	CONDITIONS			LIMITS AT INDICATED TEMPERATURES (°C)							UNITS
	V <sub>O</sub> (V)	V <sub>IN</sub> (V)	V <sub>DD</sub> (V)	Values at -55, +25, +125 Apply to D, F, K, H Packages Values at -40, +25, +85 Apply to E Package							
				-55	-40	+85	+125	+25			
				Min.	Typ.	Max.					
Quiescent Device Current, I <sub>DD</sub> Max.	-	0.5	5	5	5	150	150	-	0.04	5	μA
	-	0.10	10	10	10	300	300	-	0.04	10	
	-	0.15	15	20	20	600	600	-	0.04	20	
	-	0.20	20	100	100	3000	3000	-	0.08	100	
Output Low (Sink) Current, I <sub>OL</sub> Min.	0.4	0.5	5	0.64	0.61	0.42	0.36	0.51	1	-	mA
	0.5	0.10	10	1.6	1.5	1.1	0.9	1.3	2.6	-	
	1.5	0.15	15	4.2	4	2.8	2.4	3.4	6.8	-	
Output High (Source) Current, I <sub>OH</sub> Min.	4.6	0.5	5	-0.64	-0.61	-0.42	-0.36	-0.51	-1	-	mA
	2.5	0.5	5	-2	-1.8	-1.3	-1.15	-1.6	-3.2	-	
	9.5	0.10	10	-1.6	-1.5	-1.1	-0.9	-1.3	-2.6	-	
	13.5	0.15	15	-4.2	-4	-2.8	-2.4	-3.4	-6.8	-	
Output Voltage: Low-Level, V <sub>OL</sub> Max.	-	0.5	5	0.05			-			0	V
	-	0.10	10	0.05			-			0	
	-	0.15	15	0.05			-			0	
Output Voltage: High-Level, V <sub>OH</sub> Min.	-	0.5	5	4.95			4.95			5	V
	-	0.10	10	9.95			9.95			10	
	-	0.15	15	14.95			14.95			15	
Input Low Voltage, V <sub>IL</sub> Max.	0.5, 4.5	-	5	1.5			-			1.5	V
	1.9	-	10	3			-			3	
	1.5, 13.5	-	15	4			-			4	
Input High Voltage, V <sub>IH</sub> Min.	0.5, 4.5	-	5	3.5			3.5			-	V
	1.9	-	10	7			7			-	
	1.5, 13.5	-	15	11			11			-	
Input Current I <sub>IJN</sub> Max.	-	0.18	18	±0.1	±0.1	±1	±1	-	±10 <sup>-5</sup>	±0.1	μA

## DYNAMIC ELECTRICAL CHARACTERISTICS

At T<sub>A</sub> = 25°C; Input t<sub>r</sub>, t<sub>f</sub> = 20 ns, C<sub>L</sub> = 50 pF, R<sub>L</sub> = 200 kΩ

CHARACTERISTIC	TEST CONDITIONS	V <sub>DD</sub> Volts	LIMITS		UNITS
			Typ.	Max.	
Propagation Delay Time: Comparing Inputs to Outputs, t <sub>PHL</sub> , t <sub>PLH</sub>		5	300	600	ns
		10	125	250	
		15	80	160	
Cascading Inputs to Outputs, t <sub>PHL</sub> , t <sub>PLH</sub>		5	200	400	ns
		10	80	160	
		15	60	120	
Transition Time, t <sub>THL</sub> , t <sub>TLH</sub>		5	100	200	ns
		10	50	100	
		15	40	80	
Input Capacitance, C <sub>IN</sub>	Any Input		5	7.5	pF

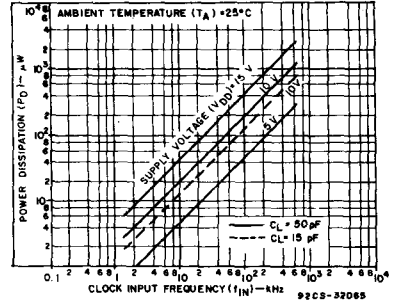

Fig. 8 - Typical dynamic power dissipation as a function of clock input frequency (see Fig. 9 - dynamic power dissipation test circuit).

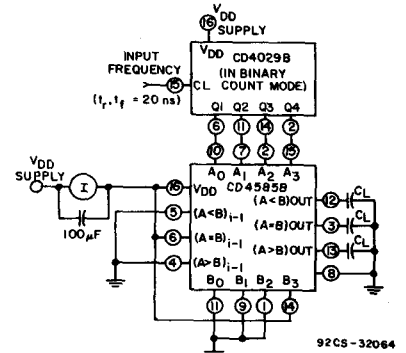

Fig. 9 - Dynamic power dissipation test circuit.

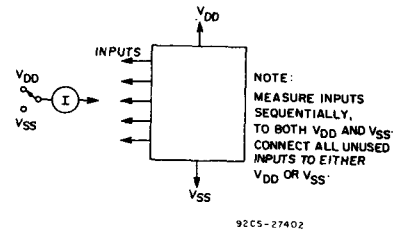

Fig. 10 - Input current test circuit.

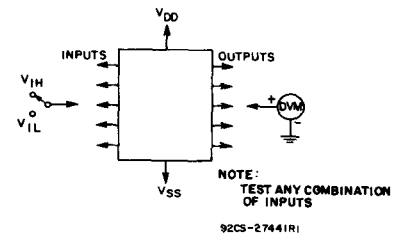

Fig. 11 - Input-voltage test circuit.

# CD4585B Types

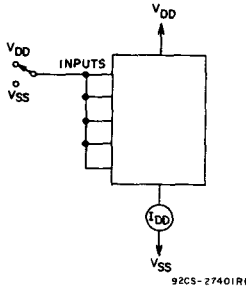
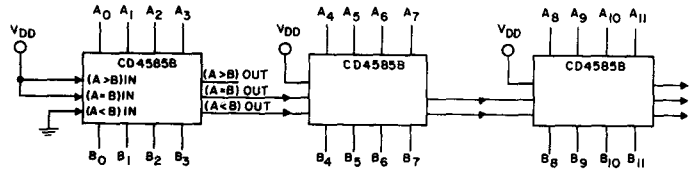

Fig. 12 — Quiescent-device-current test circuit.



$$t_p \text{ TOTAL} = t_p (\text{COMPARE}) + 2 \times t_p (\text{CASCADE}), \text{ AT } V_{DD} = 10\text{V}$$

(3 STAGES)

$$= 120 + 2(60) = 240 \text{ ns (TYP)}$$

Fig. 13 — Typical speed characteristics of a 12-bit comparator.

## TERMINAL ASSIGNMENT

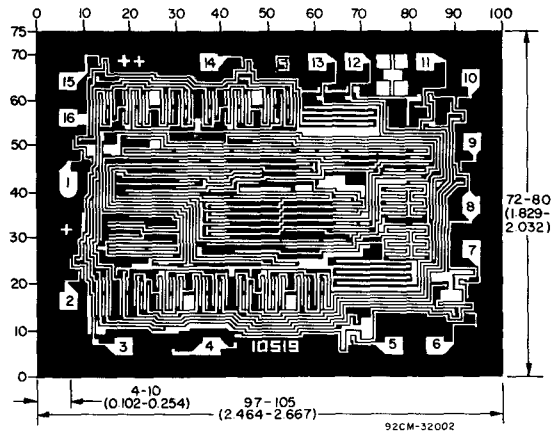
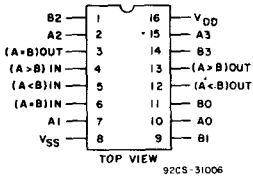

Dimensions and Pad Layout for CD4585BH

Dimensions in parentheses are in millimeters and are derived from the basic inch dimensions as indicated. Grid graduations are in mils ( $10^{-3}$  inch).

The photographs and dimensions of each CMOS chip represent a chip when it is part of the wafer. When the wafer is separated into individual chips, the angle of cleavage may vary with respect to the chip face for different chips. The actual dimensions of the isolated chip, therefore, may differ slightly from the nominal dimensions shown. The user should consider a tolerance of  $-3$  mils to  $+16$  mils applicable to the nominal dimensions shown.



## CMOS 8-Bit Addressable Latch

### High-Voltage Types (20-Volt Rating)

The RCA-CD4724B 8-bit addressable latch is a serial-input, parallel-output storage register that can perform a variety of functions.

Data are inputted to a particular bit in the latch when that bit is addressed (by means of inputs A0, A1, A2) and when WRITE DISABLE is at a low level. When WRITE DISABLE is high, data entry is inhibited; however, all 8 outputs can be continuously read independent of WRITE DISABLE and address inputs.

A master RESET input is available, which resets all bits to a logic "0" level when RESET and WRITE DISABLE are at a high level. When RESET is at a high level, and WRITE DISABLE is at a low level, the latch acts as a 1-of-8 demultiplexer; the bit that is addressed has an active output which follows the data input, while all unaddressed bits are held to a logic "0" level.

The CD4724B types are supplied in 16-lead hermetic ceramic dual-in-line packages (D and F suffixes), 16-lead plastic dual-in-line packages (E suffix), and in chip form (H suffix).

### Features:

- Serial data input    ■ Active parallel output
- Storage register capability    ■ Master clear
- Can function as demultiplexer
- Standardized, symmetrical output characteristics
- 100% tested for quiescent current at 20 V
- Maximum input current of 1  $\mu$ A at 18 V (full package-temperature range), 100 nA at 18 V and 25°C
- Noise margin (full package-temperature range) = 1 V at  $V_{DD} = 5$  V, 2 V at  $V_{DD} = 10$  V, 2.5 V at  $V_{DD} = 15$  V
- 5-V, 10-V, and 15-V parametric ratings
- Meets all requirements of JEDEC Tentative Standard No. 13A, "Standard Specifications for Description of 'B' Series CMOS Devices"

### MAXIMUM RATINGS, Absolute-Maximum Values:

DC SUPPLY-VOLTAGE RANGE, ( $V_{DD}$ ) (Voltages referenced to $V_{SS}$ Terminal)	-0.5 to +20 V
INPUT VOLTAGE RANGE, ALL INPUTS	-0.5 to $V_{DD} + 0.5$ V
DC INPUT CURRENT, ANY ONE INPUT	$\pm 10$ mA
POWER DISSIPATION PER PACKAGE ( $P_D$ ):	
For $T_A = -40$ to $+60^\circ\text{C}$ (PACKAGE TYPE E)	500 mW
For $T_A = +60$ to $+85^\circ\text{C}$ (PACKAGE TYPE E)	Derate Linearly at 12 mW/ $^\circ\text{C}$ to 200 mW
For $T_A = -55$ to $+100^\circ\text{C}$ (PACKAGE TYPES D, F)	500 mW
For $T_A = +100$ to $+125^\circ\text{C}$ (PACKAGE TYPES D, F)	Derate Linearly at 12 mW/ $^\circ\text{C}$ to 200 mW
DEVICE DISSIPATION PER OUTPUT TRANSISTOR FOR $T_A =$ FULL PACKAGE-TEMPERATURE RANGE (All Package Types)	100 mW
OPERATING-TEMPERATURE RANGE ( $T_A$ ):	
PACKAGE TYPES D, F, H	-55 to $+125^\circ\text{C}$
PACKAGE TYPE E	-40 to $+85^\circ\text{C}$
STORAGE TEMPERATURE RANGE ( $T_{stg}$ )	-65 to $+150^\circ\text{C}$
LEAD TEMPERATURE (DURING SOLDERING): At distance 1/16 $\pm$ 1/32 inch (1.59 $\pm$ 0.79 mm) from case for 10 s max.	$+265^\circ\text{C}$

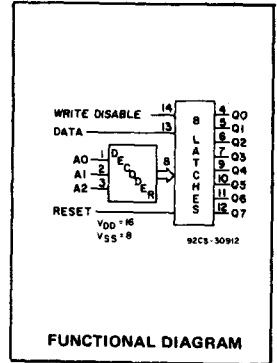

### Applications:

- Multi-line decoders
- A/D converters

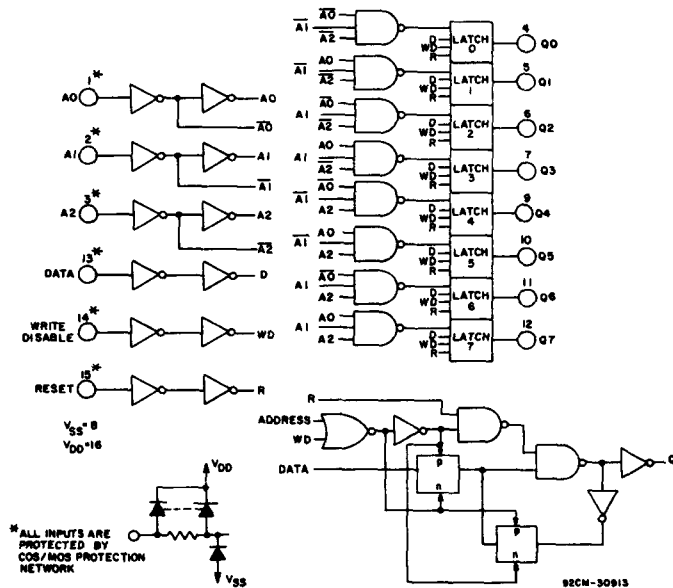
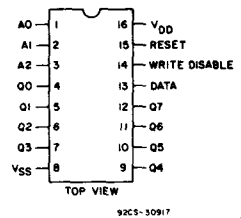

Fig. 1— Logic diagram of CD4724B and detail of 1 of 8 latches.



### TERMINAL ASSIGNMENT

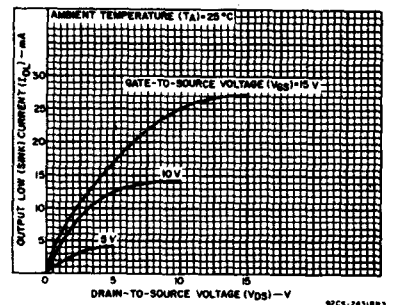

Fig. 2— Typical output low (sink) current characteristics.

# CD4724B Types

**RECOMMENDED OPERATING CONDITIONS** at  $T_A = 25^\circ\text{C}$  (Unless otherwise specified)  
 For maximum reliability, nominal operating conditions should be selected so that operation is always within the following ranges.

CHARACTERISTIC	SEE FIG. 15*	V <sub>DD</sub> (V)	LIMITS		UNITS
			MIN.	MAX.	
Supply Voltage Range: (At $T_A$ = Full Package Temperature Range)			3	18	V
Pulse Width, $t_{PW}$ Data	4	5	200	—	ns
		10	100	—	
		15	80	—	
Address	8	5	400	—	ns
		10	200	—	
		15	125	—	
Reset	5	5	150	—	ns
		10	75	—	
		15	50	—	
Setup Time, $t_S$ Data to WRITE DISABLE	6	5	100	—	ns
		10	50	—	
		15	35	—	
Hold Time, $t_H$ Data to WRITE DISABLE	7	5	150	—	ns
		10	75	—	
		15	50	—	

\* Circled numbers refer to times indicated on master timing diagram.

Note: In addition to the above characteristics, a WRITE DISABLE ON time (the time that WRITE DISABLE is at a high level) must be observed during an address change for the total time that the external address lines A0, A1, and A2 are settling to a stable level, to prevent a wrong call from being addressed.

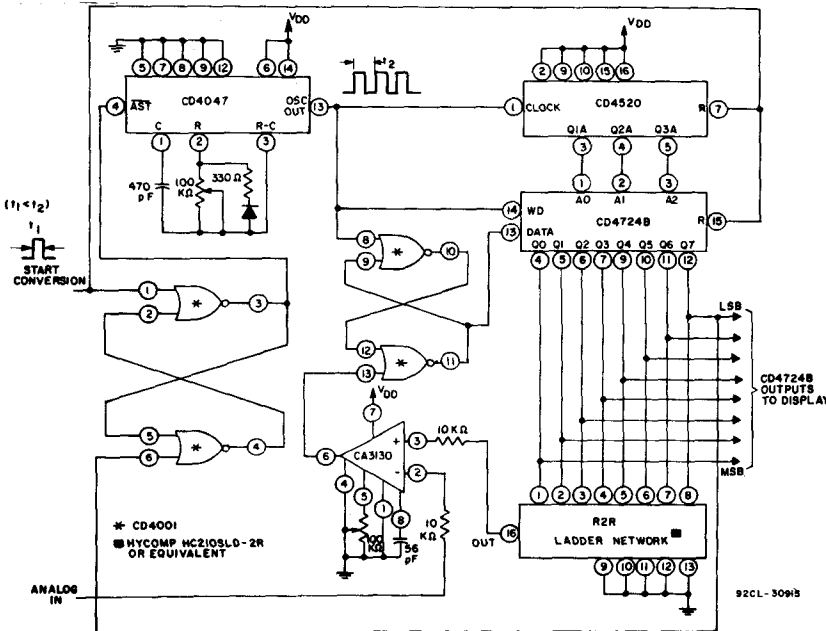
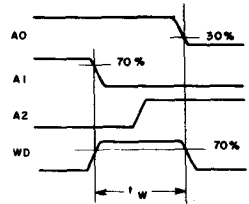

Fig. 5—A/D converter

MODE SELECTION			
WD	R	ADDRESSED LATCH	UNADDRESSED LATCH
0	0	Follows Data	Holds Previous State
0	1	Follows Data (Active High 8-Channel Demultiplexer)	Reset to "0"
1	0	Holds Previous State	
1	1	Reset to "0"	Reset to "0"

WD = WRITE DISABLE R = RESET



92CS-27676R1

Fig. 3—Definition of WRITE DISABLE ON time.

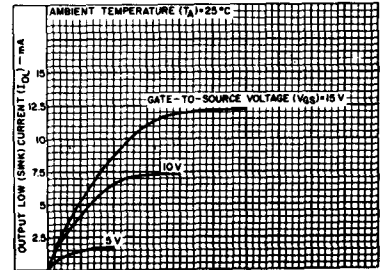

92CS-24319R1

Fig. 4—Minimum output low (sink) current characteristics.

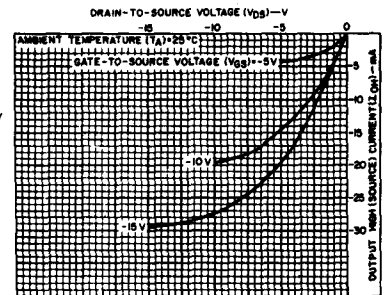

92CS-24320R5

Fig. 5—Typical output high (source) current characteristics.

# CD4724B Types

## STATIC ELECTRICAL CHARACTERISTICS

CHARACTERISTIC	CONDITIONS			LIMITS AT INDICATED TEMPERATURES (°C)							UNITS
	V <sub>O</sub> (V)	V <sub>IN</sub> (V)	V <sub>DD</sub> (V)	Values at -55, +25, +125 Apply to D,F,H Packages Values at -40, +25, +85 Apply to E Package							
				-55	-40	+85	+125	+25			
				Min.	Typ.	Max.					
Quiescent Device Current, I <sub>DD</sub> Max.	-	0.5	5	5	5	150	150	-	0.04	5	μA
	-	0.10	10	10	10	300	300	-	0.04	10	
	-	0.15	15	20	20	600	600	-	0.04	20	
	-	0.20	20	100	100	3000	3000	-	0.08	100	
Output Low (Sink) Current I <sub>OL</sub> Min.	0.4	0.5	5	0.64	0.61	0.42	0.36	0.51	1	-	mA
	0.5	0.10	10	1.6	1.5	1.1	0.9	1.3	2.6	-	
	1.5	0.15	15	4.2	4	2.8	2.4	3.4	6.8	-	
Output High (Source) Current, I <sub>OH</sub> Min.	4.6	0.5	5	-0.64	-0.61	-0.42	-0.36	-0.51	-1	-	mA
	2.5	0.5	5	-2	-1.8	-1.3	-1.15	-1.6	-3.2	-	
	9.5	0.10	10	-1.6	-1.5	-1.1	-0.9	-1.3	-2.6	-	
	13.5	0.15	15	-4.2	-4	-2.8	-2.4	-3.4	-6.8	-	
Output Voltage: Low-Level, V <sub>OL</sub> Max.	-	0.5	5	0.05			-	0	0.05	-	V
	-	0.10	10	0.05			-	0	0.05	-	
	-	0.15	15	0.05			-	0	0.05	-	
Output Voltage: High-Level, V <sub>OH</sub> Min.	-	0.5	5	4.95			4.95	5	-	-	V
	-	0.10	10	9.95			9.95	10	-	-	
	-	0.15	15	14.95			14.95	15	-	-	
Input Low Voltage, V <sub>IL</sub> Max.	0.5, 4.5	-	5	1.5			-	-	1.5	-	V
	1, 9	-	10	3			-	-	3	-	
	1.5, 13.5	-	15	4			-	-	4	-	
Input High Voltage, V <sub>IH</sub> Min.	0.5, 4.5	-	5	3.5			3.5	-	-	-	V
	1, 9	-	10	7			7	-	-	-	
	1.5, 13.5	-	15	11			11	-	-	-	
Input Current I <sub>IN</sub> Max.	-	0.18	18	±0.1	±0.1	±1	±1	-	±10 <sup>-5</sup>	±0.1	μA

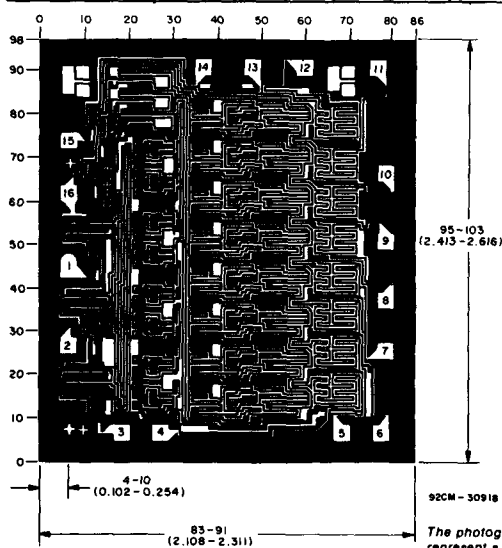

### CD4724BH DIMENSIONS AND PAD LAYOUT

Dimensions in parentheses are in millimeters and are derived from the basic inch dimensions as indicated. Grid graduations are in mils (10<sup>-3</sup> inch).

The photographs and dimensions of each CMOS chip represent a chip when it is part of the wafer. When the wafer is separated into individual chips, the angle of cleavage may vary with respect to the chip face for different chips. The actual dimensions of the isolated chip, therefore, may differ slightly from the nominal dimensions shown. The user should consider a tolerance of -3 mils to +16 mils applicable to the nominal dimensions shown.

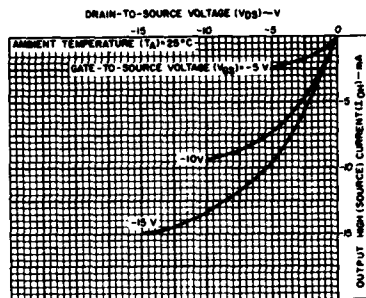

Fig. 7 - Minimum output high (source) current characteristics.

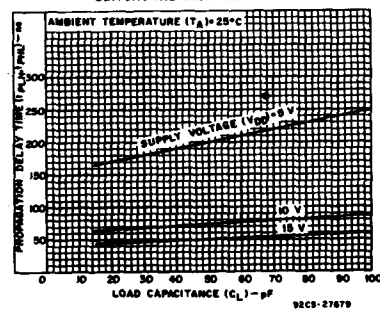

Fig. 8 - Typical propagation delay time (data to Qn) vs. load capacitance.

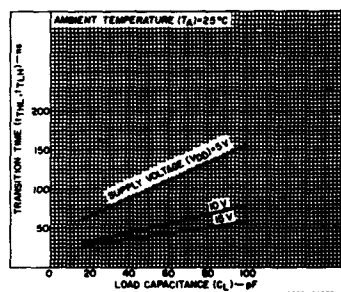

Fig. 9 - Typical transition time vs. load capacitance.

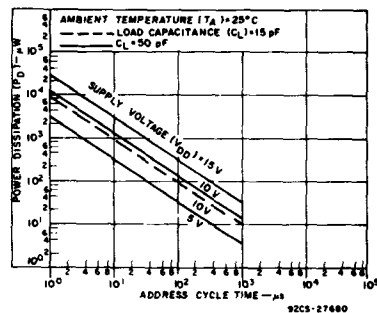

Fig. 10 - Typical dynamic power dissipation vs. address cycle time.

# CD4724B Types

**DYNAMIC ELECTRICAL CHARACTERISTICS at  $T_A = 25^\circ\text{C}$ ,  $C_L = 50\text{ pF}$**   
 Input  $t_r, t_f = 20\text{ ns}$ ,  $R_L = 200\text{ K}\Omega$

CHARACTERISTIC	CONDITIONS		LIMITS		UNITS
	SEE Fig. 15*	$V_{DD}$ (V)	ALL PACKAGE TYPES		
			TYP.	MAX.	
Propagation Delay: $t_{PLH}$ , $t_{PHL}$	①	5	200	400	ns
		10	75	150	
		15	50	100	
Data to Output, WRITE DISABLE to Output, $t_{PLH}$ , $t_{PHL}$	②	5	200	400	
		10	80	160	
		15	60	120	
Reset to Output, $t_{PHL}$	③	5	175	350	
		10	80	160	
		15	65	130	
Address to Output, $t_{PLH}$ , $t_{PHL}$	⑨	5	225	450	
		10	100	200	
		15	75	150	
Transition Time, (Any Output) $t_{THL}$ , $t_{TLH}$		5	100	200	ns
		10	50	100	
		15	40	80	
Minimum Pulse Width, $t_W$ Data	④	5	100	200	ns
		10	50	100	
		15	40	80	
Address	⑧	5	200	400	ns
		10	100	200	
		15	65	125	
Reset	⑤	5	75	150	ns
		10	40	75	
		15	25	50	
Minimum Setup Time, $t_S$ Data to WRITE DISABLE	⑥	5	50	100	ns
		10	25	50	
		15	20	35	
Minimum Hold Time, $t_H$ Data to WRITE DISABLE	⑦	5	75	150	ns
		10	40	75	
		15	25	50	
Input Capacitance, $C_{IN}$	Any Input		5	7.5	pF

\*Circled numbers refer to times indicated on master timing diagram.

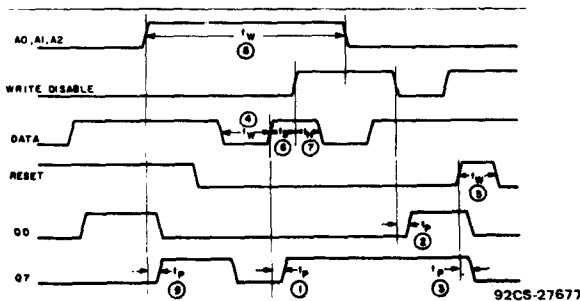

Fig. 15— Master timing diagram.

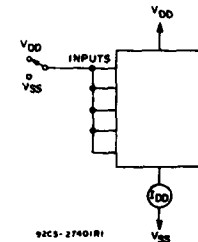

Fig. 11— Quiescent device current test circuit.

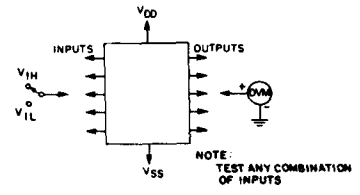

Fig. 12— Input voltage test circuit.

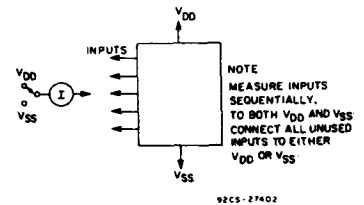

Fig. 13— Input current test circuit.

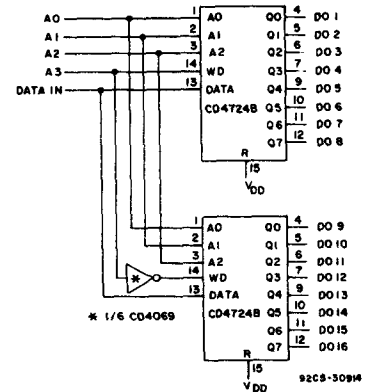

Fig. 14— 1 of 16 decoder/demultiplexer.

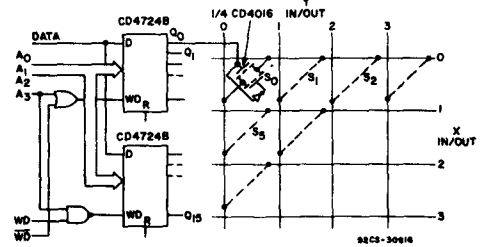

Fig. 16— Multiple selection decoding — 4 x 4 crosspoint switch.

# CMOS 32-Stage Static Left/Right Shift Register

The RCA-CD40100B is a 32-stage shift register containing 32 D-type master-slave flip-flops.

The data present at the SHIFT-RIGHT INPUT is transferred into the first register stage synchronously with the positive CLOCK edge, provided the LEFT/RIGHT CONTROL is at a low level, the RECIRCULATE CONTROL is at a high level, and the CLOCK INHIBIT is low. If the LEFT/RIGHT CONTROL is at a high level and the RECIRCULATE CONTROL is also high, data at the SHIFT-LEFT INPUT is transferred into the 32nd register stage synchronously with the positive CLOCK transition, provided the CLOCK INHIBIT is low. The state of the LEFT/RIGHT CONTROL, RECIRCULATE CONTROL, and CLOCK INHIBIT should not be changed when the CLOCK is high.

Data is shifted one stage left or one stage right depending on the state of the LEFT/RIGHT CONTROL, synchronously with the positive CLOCK edge. Data clocked into the first or 32nd register states is available at the SHIFT-LEFT or SHIFT-RIGHT OUTPUT respectively, on the next negative CLOCK transition (see Data Transfer Table). No shifting occurs on the positive CLOCK edge if the CLOCK INHIBIT line is at a high level. With the RECIRCULATE CONTROL low, data in the 32nd stage is shifted into the

## High-Voltage Types (20-Volt Rating)

### Features:

- Fully static operation
- Shift left/Shift right capability
- Multiple package cascading
- Recirculate capability
- LIFO or FIFO capability
- Standardized, symmetrical output characteristics
- 100% tested for quiescent current at 20 V
- Maximum input current of 1  $\mu$ A at 18 V over full package-temperature range; 100 nA at 18 V and 25°C
- Noise margin (full package-temperature range) =
  - 1 V at  $V_{DD} = 5$  V
  - 2 V at  $V_{DD} = 10$  V
  - 2.5 V at  $V_{DD} = 15$  V
- 5-V, 10-V, and 15-V parametric ratings
- Meets all requirements of JEDEC Tentative Standard No. 13A, "Standard Specifications for Description of 'B' Series CMOS Devices"

first stage when the LEFT/RIGHT CONTROL is low and from the 1st stage to the 32nd stage when the LEFT/RIGHT CONTROL is high.

The CD40100B types are supplied in 16-lead hermetic dual-in-line ceramic packages (D and F suffixes), 16-lead dual-in-line plastic packages (E suffix), 16-lead ceramic flat packages (K suffix), and in chip form (H suffix).

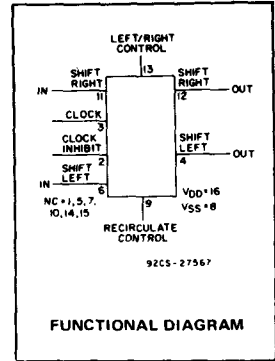

### Applications:

- Serial shift registers
- Time delay circuits
- Expandable N-bit data storage stack (LIFO operation)

### MAXIMUM RATINGS, Absolute-Maximum Values:

DC SUPPLY-VOLTAGE RANGE, ( $V_{DD}$ ) (Voltages referenced to $V_{SS}$ Terminal)	-0.5 to +20 V
INPUT VOLTAGE RANGE, ALL INPUTS	-0.5 to $V_{DD} + 0.5$ V
DC INPUT CURRENT, ANY ONE INPUT	$\pm 10$ mA
POWER DISSIPATION PER PACKAGE ( $P_D$ ):	
For $T_A = -40$ to $+60^\circ\text{C}$ (PACKAGE TYPE E)	500 mW
For $T_A = +60$ to $+85^\circ\text{C}$ (PACKAGE TYPE E)	Derate Linearly at 12 mW/ $^\circ\text{C}$ to 200 mW
For $T_A = -55$ to $+100^\circ\text{C}$ (PACKAGE TYPES D, F, K)	500 mW
For $T_A = +100$ to $+125^\circ\text{C}$ (PACKAGE TYPES D, F, K)	Derate Linearly at 12 mW/ $^\circ\text{C}$ to 200 mW
DEVICE DISSIPATION PER OUTPUT TRANSISTOR:	
For $T_A = \text{FULL PACKAGE-TEMPERATURE RANGE (All Package Types)}$	100 mW
OPERATING-TEMPERATURE RANGE ( $T_A$ ):	
PACKAGE TYPES D, F, K, H	$-55$ to $+125^\circ\text{C}$
PACKAGE TYPE E	$-40$ to $+85^\circ\text{C}$
STORAGE TEMPERATURE RANGE ( $T_{stg}$ )	$-65$ to $+150^\circ\text{C}$
LEAD TEMPERATURE (DURING SOLDERING):	
At distance $1/16 \pm 1/32$ inch ( $1.59 \pm 0.79$ mm) from case for 10 s max.	$+265^\circ\text{C}$

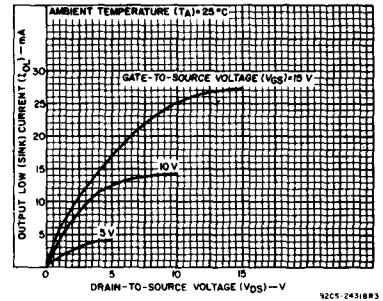

Fig. 1 - Typical output low (sink) current characteristics.

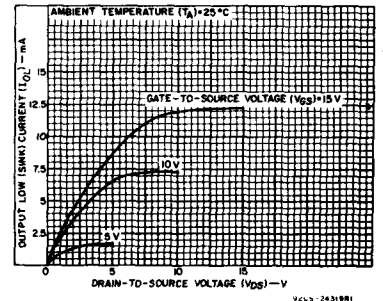

Fig. 2 - Minimum output low (sink) current characteristics.

# CD40100B Types

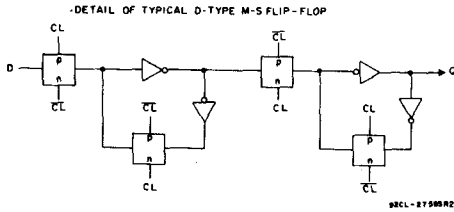
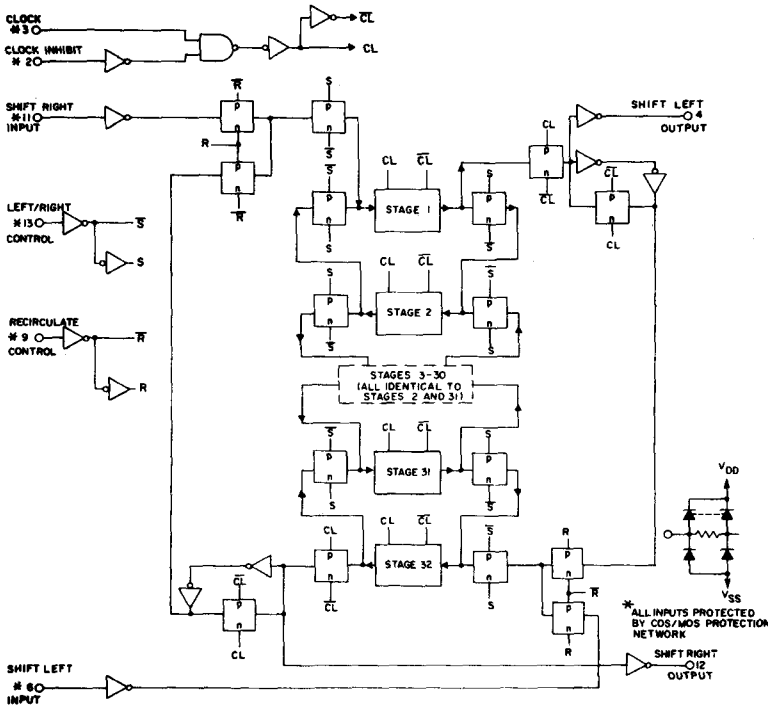

Fig. 3 - Logic diagram.

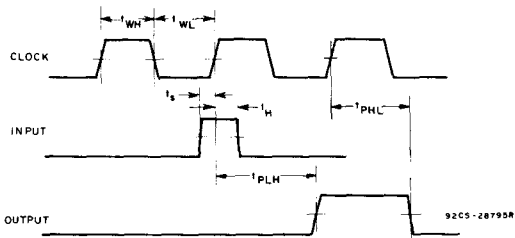

Fig. 4 - Timing diagram defining setup, hold, and propagation delay times.

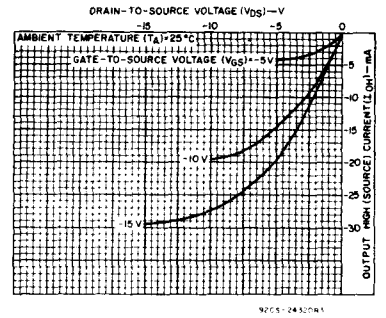

Fig. 5 - Typical output high (source) current characteristics.

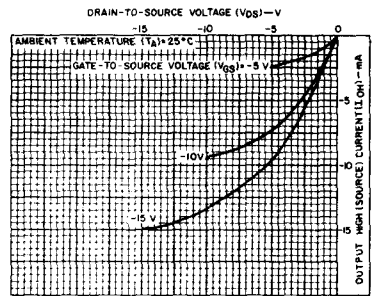

Fig. 6 - Minimum output high (source) current characteristics.

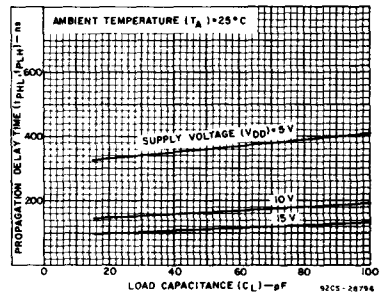

Fig. 7 - Typical propagation delay time (CLOCK to SHIFT LEFT/RIGHT) as a function of load capacitance.

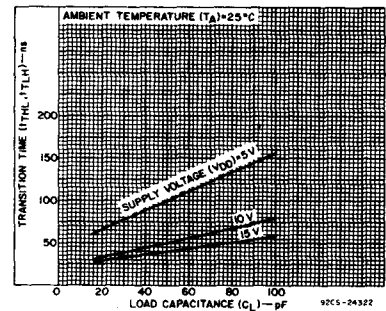

Fig. 8 - Typical transition time as a function of load capacitance.

# CD40100B Types

**RECOMMENDED OPERATING CONDITIONS** at  $T_A = 25^\circ\text{C}$ , Except as Noted.  
**For maximum reliability, nominal operating conditions should be selected so that operation is always within the following ranges:**

CHARACTERISTIC	$V_{DD}$ (V)	LIMITS		UNITS
		Min.	Max.	
Supply-Voltage Range (For $T_A$ = Full Package-Temperature Range)		3	18	V
Data Setup Time, $t_S$	5 10 15	100	—	ns
Data Hold Time, $t_H$	5 10 15	275 100 75	—	ns
Clock Input Frequency, $f_{CL}$	5 10 15	dc	1 2.5 3	mHz
Clock Input Rise or Fall Time, $t_{r,CL}$ , $t_{f,CL}$	5 10 15	—	15 15 15	$\mu\text{s}$
Clock Input Pulse Width: Low Level, $t_{WL}$	5 10 15	450 230 190	—	ns
High Level, $t_{WH}$	5 10 15	280 150 140	—	ns

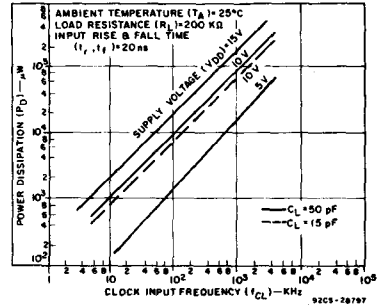

Fig. 9 - Typical dynamic power dissipation as a function of CLOCK frequency.

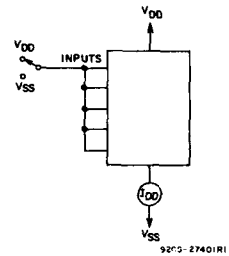

Fig. 10 - Quiescent-device-current test circuit.

### CONTROL TRUTH TABLE

LEFT/RIGHT CONTROL	CLOCK INHIBIT	RECIRCULATE CONTROL	ACTION	INPUT BIT ORIGIN
1	0	1	Shift left	Shift left input
1	0	0	Shift left	Stage 1
0	0	1	Shift right	Shift right input
0	0	0	Shift right	Stage 32
X	1	X	No shift	—

### DATA TRANSFER TABLE\*

INITIAL STATE			CLOCK	RESULTING STATE	
DATA INPUT	CLOCK INHIBIT	INTERNAL STAGE	LEVEL CHANGE	INTERNAL STAGE Q	OUTPUT
0	0	X		0	NC
X	0	0		NC	0
1	0	X		1	NC
X	0	1		NC	1
X	1	1	X	NC	NC

0 = Low level 1 = High level X = Don't care NC = No change

\* For Shift-Right Mode

Data Input = SHIFT-RIGHT INPUT (Term. 11)

Internal Stage = Stage 1 ( $Q_1$ )

Output = SHIFT-LEFT OUTPUT (Term. 4)

For Shift-Left Mode

Data Input = SHIFT-LEFT INPUT (Term. 6)

Internal Stage = Stage 32 ( $Q_{32}$ )

Output = SHIFT-RIGHT OUTPUT (Term. 12)

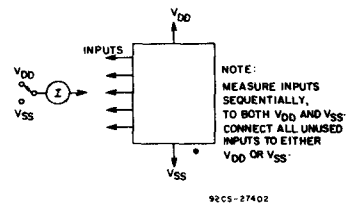

Fig. 11 - Input-current test circuit.

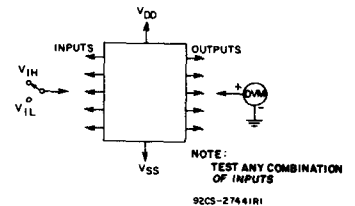
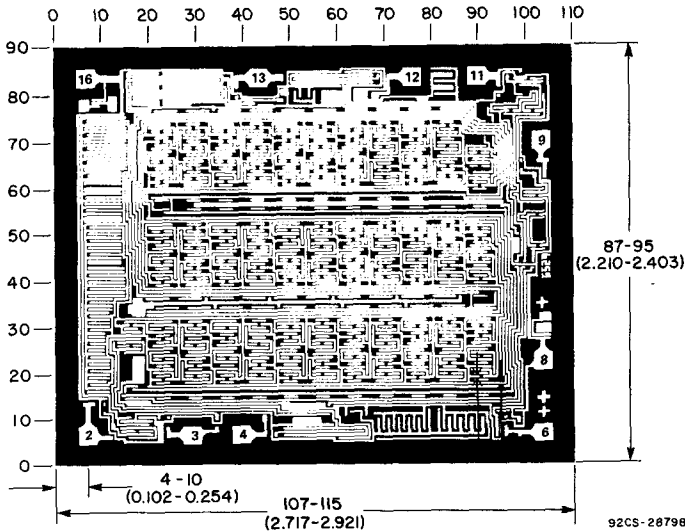

Fig. 12 - Input-voltage test circuit.

# CD40100B Types

## STATIC ELECTRICAL CHARACTERISTICS

CHARACTER- ISTIC	CONDITIONS			LIMITS AT INDICATED TEMPERATURES (°C)							UNITS
	V <sub>O</sub> (V)	V <sub>IN</sub> (V)	V <sub>DD</sub> (V)	Values at -55, +25, +125 Apply to D, F, K, H Packages				Values at -40, +25, +85 Apply to E Package			
				-55	-40	+85	+125	+25			
				Min.	Typ.	Max.					
Quiescent Device Current, I <sub>DD</sub> Max.	-	0,5	5	5	5	150	150	-	0,04	5	μA
	-	0,10	10	10	10	300	300	-	0,04	10	
	-	0,15	15	20	20	600	600	-	0,04	20	
	-	0,20	20	100	100	3000	3000	-	0,08	100	
Output Low (Sink) Current I <sub>OL</sub> Min.	0,4	0,5	5	0,64	0,61	0,42	0,36	0,51	1	-	mA
	0,5	0,10	10	1,6	1,5	1,1	0,9	1,3	2,6	-	
	1,5	0,15	15	4,2	4	2,8	2,4	3,4	6,8	-	
Output High (Source) Current, I <sub>OH</sub> Min.	4,6	0,5	5	-0,64	-0,61	-0,42	-0,36	-0,51	-1	-	mA
	2,5	0,5	5	-2	-1,8	-1,3	-1,15	-1,6	-3,2	-	
	9,5	0,10	10	-1,6	-1,5	-1,1	-0,9	-1,3	-2,6	-	
	13,5	0,15	15	-4,2	-4	-2,8	-2,4	-3,4	-6,8	-	
Output Voltage: Low-Level, V <sub>OL</sub> Max.	-	0,5	5	0,05				-	0	0,05	V
	-	0,10	10	0,05				-	0	0,05	
	-	0,15	15	0,05				-	0	0,05	
Output Voltage: High-Level, V <sub>OH</sub> Min.	-	0,5	5	4,95				4,95	5	-	V
	-	0,10	10	9,95				9,95	10	-	
	-	0,15	15	14,95				14,95	15	-	
Input Low Voltage, V <sub>IL</sub> Max.	0,5, 4,5	-	5	1,5				-	-	1,5	V
	1,9	-	10	3				-	-	3	
	1,5, 13,5	-	15	4				-	-	4	
Input High Voltage, V <sub>IH</sub> Min.	0,5, 4,5	-	5	3,5				3,5	-	-	V
	1,9	-	10	7				7	-	-	
	1,5, 13,5	-	15	11				11	-	-	
Input Current I <sub>IN</sub> Max.	-	0,18	18	±0,1	±0,1	±1	±1	-	±10 <sup>-5</sup>	±0,1	μA



The photographs and dimensions of each CMOS chip represent a chip when it is part of the wafer. When the wafer is separated into individual chips, the angle of cleavage may vary with respect to the chip face for different chips. The actual dimensions of the isolated chip, therefore, may differ slightly from the nominal dimensions shown. The user should consider a tolerance of -3 mils to +16 mils applicable to the nominal dimensions shown.

Dimensions and pad layout for CD40100BH.

Dimensions in parentheses are in millimeters and are derived from the basic inch dimensions as indicated. Grid graduations are in mils (10<sup>-3</sup> inch).



# CD40100B Types

DYNAMIC ELECTRICAL CHARACTERISTICS at  $T_A = 25^\circ\text{C}$ , Input  $t_r, t_f = 20 \text{ ns}$ ,  
 $C_L = 50 \text{ pF}$ ,  $R_L = 200 \text{ k}\Omega$

CHARACTERISTIC	TEST CONDITIONS	LIMITS			UNITS	
		$V_{DD}$ V	Min.	Typ.		Max.
Propagation Delay Time: Clock to Shift Left/Right Output, $t_{PLH}, t_{PHL}$		5		360	720	ns
		10		165	330	
		15		115	230	
Transition Time, $t_{THL}, t_{TLH}$		5		100	200	ns
		10		50	100	
		15		40	80	
Minimum Data Setup Time, $t_S$		5		50	100	ns
		10		10	20	
		15		5	10	
Minimum Data Hold Time, $t_H$		5		170	275	ns
		10		75	100	
		15		50	75	
Maximum Clock Input Frequency, $f_{CL}$		5	1	2		MHz
		10	2.5	5		
		15	3	6		
Minimum Clock Input Pulse Width: Low Level, $t_{WL}$		5		225	450	ns
		10		115	230	
		15		95	190	
High Level, $t_{WH}$		5		140	280	ns
		10		75	150	
		15		70	140	
Input Capacitance, $C_{IN}$	Any Input	—		5	7.5	pF

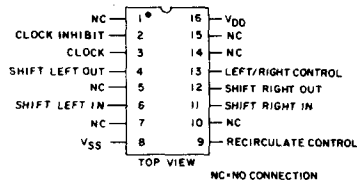

92CS-2756B

## TERMINAL ASSIGNMENT

# CD40101B Types

## CMOS 9-Bit Parity Generator/Checker

High-Voltage Types (20-Volt Rating)

The RCA-CD40101B is a 9-bit (8 data bits plus 1 parity bit) parity generator/checker. It may be used to detect errors in data transmission or data retrieval. Odd and even outputs facilitate odd or even parity generation and checking.

When used as a parity generator, a parity bit is supplied along with the data to generate an even or odd parity output.

When used as a parity checker, the received data bits and parity bits are compared for correct parity. The even or odd outputs are used to indicate an error in the received data.

Word-length capability is expandable by cascading. The CD40101B is also provided with an inhibit control. If the inhibit control is set at logical "1", the even and odd outputs go to a logical "0".

The CD40101B types are supplied in 14-lead dual-in-line ceramic packages (D and F suffixes), 14-lead dual-in-line plastic packages (E suffix), 14-lead ceramic flat packages (K suffix), and in chip form (H suffix).

### Features:

- 100% tested for maximum quiescent current at 20 V
- Maximum input current of 1  $\mu$ A at 18 V over full package-temperature range; 100 nA at 18 V and 25°C
- Noise margin (full package-temperature range):
  - 1 V at  $V_{DD} = 5$  V
  - 2 V at  $V_{DD} = 10$  V
  - 2.5 V at  $V_{DD} = 15$  V
- 5-V, 10-V, and 15-V parametric ratings
- Standardized, symmetrical output characteristics
- Meets all requirements of JEDEC Tentative Standard No. 13A, "Standard Specifications for Description of 'B' Series CMOS Devices."

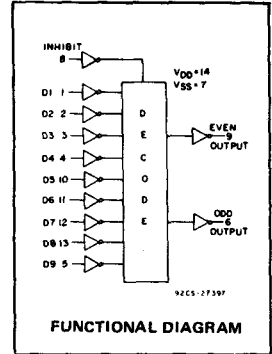

### MAXIMUM RATINGS, Absolute-Maximum Values:

DC SUPPLY-VOLTAGE RANGE, ( $V_{DD}$ )	-0.5 to +20 V
(Voltages referenced to $V_{SS}$ Terminal)	
INPUT VOLTAGE RANGE, ALL INPUTS	-0.5 to $V_{DD} + 0.5$ V
DC INPUT CURRENT, ANY ONE INPUT	$\pm 10$ mA
POWER DISSIPATION PER PACKAGE ( $P_D$ ):	
For $T_A = -40$ to $+60^\circ$ C (PACKAGE TYPE E)	500 mW
For $T_A = +60$ to $+85^\circ$ C (PACKAGE TYPE E)	Derate Linearly at 12 mW/ $^\circ$ C to 200 mW
For $T_A = -55$ to $+100^\circ$ C (PACKAGE TYPES D, F, K)	500 mW
For $T_A = +100$ to $+125^\circ$ C (PACKAGE TYPES D, F, K)	Derate Linearly at 12 mW/ $^\circ$ C to 200 mW
DEVICE DISSIPATION PER OUTPUT TRANSISTOR:	
For $T_A =$ FULL PACKAGE-TEMPERATURE RANGE (All Package Types)	100 mW
OPERATING-TEMPERATURE RANGE ( $T_A$ ):	
PACKAGE TYPES D, F, K, H	-55 to $+125^\circ$ C
PACKAGE TYPE E	-40 to $+85^\circ$ C
STORAGE TEMPERATURE RANGE ( $T_{stg}$ )	-65 to $+150^\circ$ C
LEAD TEMPERATURE (DURING SOLDERING):	
At distance $1/16 \pm 1/32$ inch ( $1.59 \pm 0.79$ mm) from case for 10 s max.	$+265^\circ$ C

### RECOMMENDED OPERATING CONDITIONS

For maximum reliability, nominal operating conditions should be selected so that operation is always within the following ranges:

CHARACTERISTIC	LIMITS		UNITS
	MIN.	MAX.	
Supply-Voltage Range (For $T_A =$ Full Package-Temperature Range)	3	18	V

### TERMINAL ASSIGNMENT

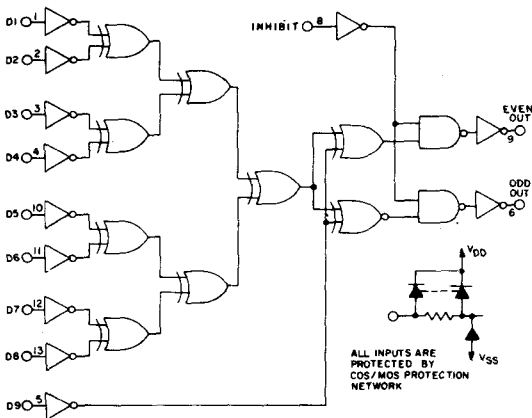
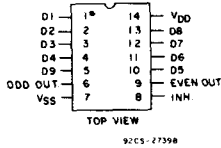

Fig. 1 — CD40101B logic diagram.

### Truth Table

Inputs	Outputs	
	Even	Odd
$\sum 1's = \text{Even}$	1	0
$\sum 1's = \text{Odd}$	0	1
X	0	0

X = Don't Care  
Logic 1 = High  
Logic 0 = Low

# CD40101B Types

## STATIC ELECTRICAL CHARACTERISTICS

CHARACTERISTIC	CONDITIONS			LIMITS AT INDICATED TEMPERATURES (°C)							UNITS
	V <sub>O</sub> (V)	V <sub>IN</sub> (V)	V <sub>DD</sub> (V)	Values at -55, +25, +125 Apply to D, F, K, H Packages			Values at -40, +25, +85 Apply to E Package				
				-55	-40	+85	+125	+25			
							Min.	Typ.	Max.		
Quiescent Device Current, I <sub>DD</sub> Max.	-	0,5	5	5	5	150	150	-	0.04	5	μA
	-	0,10	10	10	10	300	300	-	0.04	10	
	-	0,15	15	20	20	600	600	-	0.04	20	
	-	0,20	20	100	100	3000	3000	-	0.08	100	
Output Low (Sink) Current I <sub>OL</sub> Min.	0.4	0,5	5	0.64	0.61	0.42	0.36	0.51	1	-	mA
	0.5	0,10	10	1.6	1.5	1.1	0.9	1.3	2.6	-	
	1.5	0,15	15	4.2	4	2.8	2.4	3.4	6.8	-	
Output High (Source) Current I <sub>OH</sub> Min.	4.6	0,5	5	-0.64	-0.61	-0.42	-0.36	-0.51	-1	-	mA
	2.5	0,5	5	-2	-1.8	-1.3	-1.15	-1.6	-3.2	-	
	9.5	0,10	10	-1.6	-1.5	-1.1	-0.9	-1.3	-2.6	-	
	13.5	0,15	15	-4.2	-4	-2.8	-2.4	-3.4	-6.8	-	
Output Voltage: Low-Level, V <sub>OL</sub> Max.	-	0,5	5	0.05			0			0.05	V
	-	0,10	10	0.05			0			0.05	
	-	0,15	15	0.05			0			0.05	
Output Voltage: High-Level, V <sub>OH</sub> Min.	-	0,5	5	4.95			4.95			5	V
	-	0,10	10	9.95			9.95			10	
	-	0,15	15	14.95			14.95			15	
Input Low Voltage, V <sub>IL</sub> Max.	0.5, 4.5	-	5	1.5			-			1.5	V
	1, 9	-	10	3			-			3	
	1.5, 13.5	-	15	4			-			4	
Input High Voltage, V <sub>IH</sub> Min.	0.5, 4.5	-	5	3.5			3.5			-	V
	1, 9	-	10	7			7			-	
	1.5, 13.5	-	15	11			11			-	
Input Current I <sub>IN</sub> Max.		0,18	18	±0.1	±0.1	±1	±1	-	±10 <sup>-5</sup>	±0.1	μA

DYNAMIC ELECTRICAL CHARACTERISTICS at T<sub>A</sub> = 25°C; Input t<sub>r</sub>, t<sub>f</sub> = 20 ns, C<sub>L</sub> = 50 pF, R<sub>L</sub> = 200 kΩ

CHARACTERISTIC	TEST CONDITIONS	LIMITS		UNITS	
		V <sub>DD</sub> (V)	Typ.		Max.
Data Propagation Delay Time, t <sub>PHL</sub> , t <sub>PLH</sub>		5	350	700	
		10	150	300	
		15	100	200	
Inhibit-to-Output Propagation Delay Time, t <sub>PHL</sub> , t <sub>PLH</sub>		5	140	280	ns
		10	70	140	
		15	50	100	
Transition Time, t <sub>THL</sub> , t <sub>TLH</sub>		5	100	200	
		10	50	100	
		15	40	80	
Input Capacitance, C <sub>IN</sub>	Any Input		5	7.5	pF

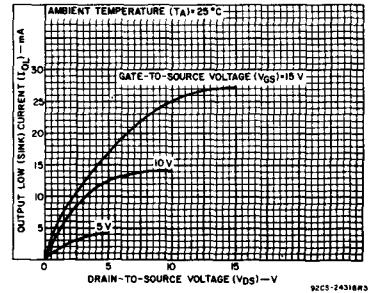

Fig.2 - Typical output low (sink) current characteristics.

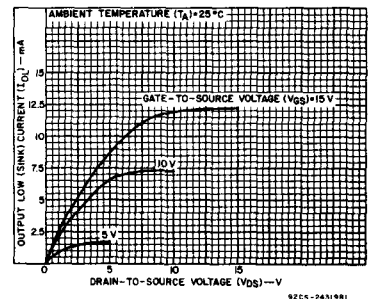

Fig.3 - Minimum output low (sink) current characteristics.

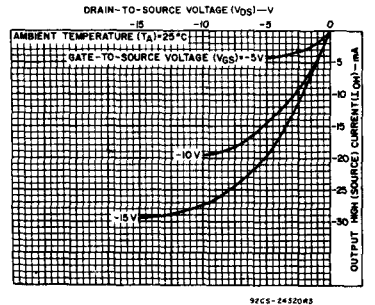

Fig.4 - Typical output high (source) current characteristics.

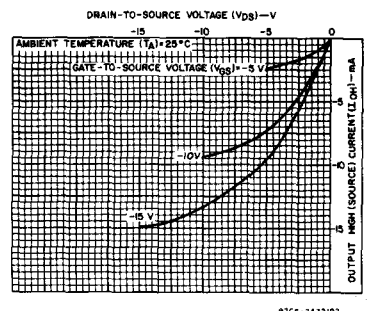

Fig.5 - Minimum output high (source) current characteristics.

# CD40101B Types

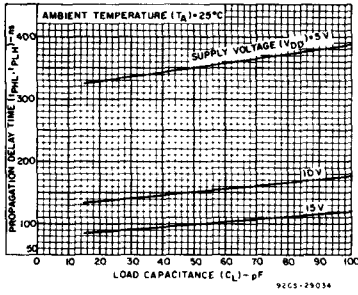

Fig. 6 — Typical propagation delay time as a function of load capacitance.

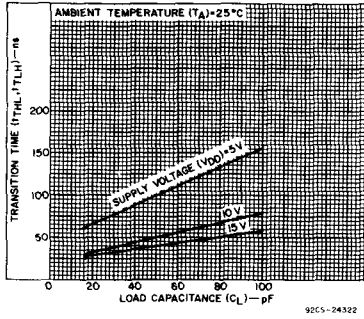

Fig. 7 — Typical transition time as a function of load capacitance.

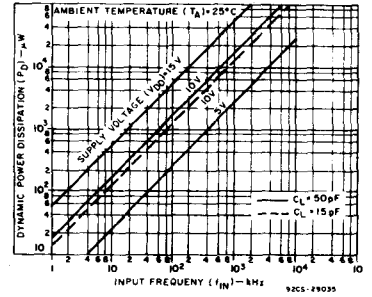

Fig. 8 — Typical dynamic power dissipation as a function of input frequency.

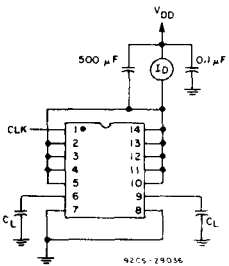

Fig. 9 — Dynamic power dissipation test circuit.

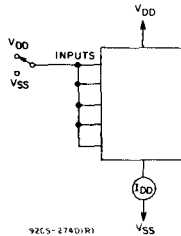

Fig. 10 — Quiescent device-current test circuit.

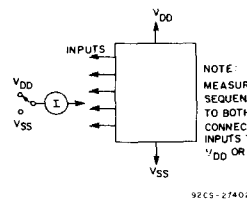

Fig. 11 — Input-leakage current.

NOTE: MEASURE INPUTS SEQUENTIALLY TO BOTH V<sub>DD</sub> AND V<sub>SS</sub>. CONNECT ALL UNUSED INPUTS TO EITHER V<sub>DD</sub> OR V<sub>SS</sub>.

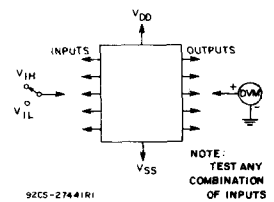
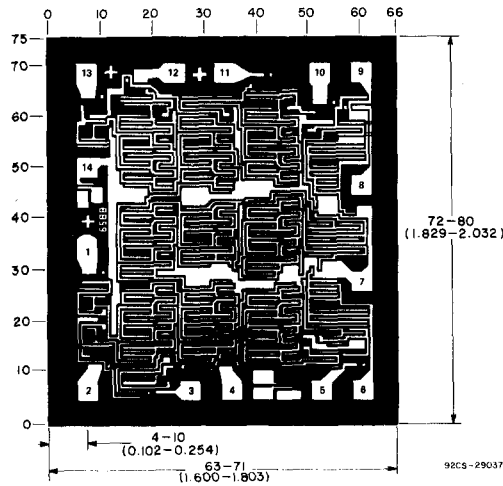

Fig. 12 — Input-voltage test circuit.

NOTE: TEST ANY COMBINATION OF INPUTS

## DIMENSIONS AND PAD LAYOUT FOR CD40101B



The photographs and dimensions of each CMOS chip represent a chip when it is part of the wafer. When the wafer is separated into individual chips, the angle of cleavage may vary with respect to the chip face for different chips. The actual dimensions of the isolated chip, therefore, may differ slightly from the nominal dimensions shown. The user should consider a tolerance of -3 mils to +16 mils applicable to the nominal dimensions shown.

Dimensions in parentheses are in millimeters and are derived from the basic inch dimensions as indicated. Grid graduations are in mils (10<sup>-3</sup> inch).

# CMOS 8-Stage Presettable Synchronous Down Counters

High-Voltage Types (20-Volt Rating)

CD40102B – 2-Decade BCD Type  
CD40103B – 8-Bit Binary Type

The RCA-CD40102B, and CD40103B consist of an 8-stage synchronous down counter with a single output which is active when the internal count is zero. The CD40102B is configured as two cascaded 4-bit BCD counters, and the CD40103B contains a single 8-bit binary counter. Each type has control inputs for enabling or disabling the clock, for clearing the counter to its maximum count, and for presetting the counter either synchronously or asynchronously. All control inputs and the CARRY-OUT/ZERO-DETECT output are active-low logic.

In normal operation, the counter is decremented by one count on each positive transition of the CLOCK. Counting is inhibited when the CARRY-IN/COUNTER ENABLE (CI/CE) input is high. The CARRY-OUT/ZERO-DETECT (CO/ZD) output goes low when the count reaches zero if the CI/CE input is low, and remains low for one full clock period.

When the SYNCHRONOUS PRESET-ENABLE (SPE) input is low, data at the JAM input is clocked into the counter on the next positive clock transition regardless of the state of the CI/CE input. When the ASYNCHRONOUS PRESET-ENABLE (APE) input is low, data at the JAM inputs is asynchronously forced into the counter regardless of the state of the SPE, CI/CE, or CLOCK inputs. JAM inputs JO-J7 represent two 4-bit BCD words for the CD40102B and a single 8-bit binary word for the CD40103B.

When the CLEAR (CLR) input is low, the counter is asynchronously cleared to its maximum count (9910 for the CD40102B and 25510 for the CD40103B) regardless of the state of any other input. The precedence relationship between control inputs is indicated in the truth table.

If all control inputs except CI/CE are high at the time of zero count, the counters will jump to the maximum count, giving a counting sequence of 100 or 256 clock pulses long.

The CD40102B and CD40103B may be cascaded using the CI/CE input and the CO/ZD output, in either a synchronous or ripple mode as shown in Figs.21 and 22.

The CD40102B and CD40103B types are supplied in 16-lead hermetic dual-in-line ceramic packages (D and F suffixes), 16-lead dual-in-line plastic packages (E suffix), 16-lead ceramic flat packages (K suffix), and in chip form (H suffix).

**Features:**

- Synchronous or asynchronous preset
- Medium-speed operation:  $f_{CL} = 3.6 \text{ MHz (typ.) @ } V_{DD} = 10 \text{ V}$
- Cascadable
- 100% tested for quiescent current at 20 V
- Maximum input current of  $1 \mu\text{A}$  at 18 V over full package-temperature range; 100 nA at 18 V and 25°C
- Noise margin (full package-temperature range) =  $1 \text{ V at } V_{DD} = 5 \text{ V}$   
 $2 \text{ V at } V_{DD} = 10 \text{ V}$   
 $2.5 \text{ V at } V_{DD} = 15 \text{ V}$
- Standardized, symmetrical output characteristics
- 5-V, 10-V, and 15-V parametric ratings
- Meets all requirements of JEDEC Tentative Standard No.13A, "Standard Specifications for Description of 'B' Series CMOS Devices"

**Applications:**

- Divide-by-"N" counters
- Programmable timers
- Interrupt timers
- Cycle/program counter

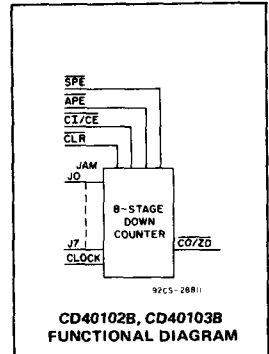

**RECOMMENDED OPERATING CONDITIONS AT  $T_A = 25^\circ\text{C}$ , Unless Otherwise Specified**  
For maximum reliability, nominal operating conditions should be selected so that operation is always within the following ranges.

Characteristic	V <sub>DD</sub>	LIMITS		Units
		Min.	Max.	
Supply Voltage Range (At $T_A =$ Full Package-Temperature Range)		3	18	V
Clock Pulse Width, $t_{W}$	5	300	—	ns
	10	180	—	
	15	80	—	
Clear Pulse Width, $t_{W}$	5	320	—	ns
	10	160	—	
	15	100	—	
APE Pulse Width, $t_{W}$	5	360	—	ns
	10	160	—	
	15	120	—	
Clock Input Frequency, $f_{CL}$	5	—	0.7	MHz
	10	—	1.8	
	15	—	2.4	
Clock Rise and Fall Time, $t_{r,CL}$ , $t_{f,CL}$	5	—	—	$\mu\text{s}$
	10	—	15	
	15	—	—	
SPE Setup Time, $t_{SU}$	5	280	—	ns
	10	140	—	
	15	100	—	
Jam Setup Time, $t_{SU}$	5	200	—	ns
	10	80	—	
	15	60	—	
CI/CE Setup Time, $t_{SU}$	5	500	—	ns
	10	250	—	
	15	150	—	

# CD40102B, CD40103B Types

## MAXIMUM RATINGS, Absolute-Maximum Values:

DC SUPPLY-VOLTAGE RANGE, (V <sub>DD</sub> ) (Voltages referenced to V <sub>SS</sub> Terminal)	-0.5 to +20 V
INPUT VOLTAGE RANGE, ALL INPUTS	-0.5 to V <sub>DD</sub> +0.5 V
DC INPUT CURRENT, ANY ONE INPUT	±10 mA
POWER DISSIPATION PER PACKAGE (P <sub>D</sub> ):	
For T <sub>A</sub> = -40 to +60°C (PACKAGE TYPE E)	500 mW
For T <sub>A</sub> = +60 to +85°C (PACKAGE TYPE E)	Derate Linearly at 12 mW/°C to 200 mW
For T <sub>A</sub> = -55 to +100°C (PACKAGE TYPES D, F, K)	500 mW
For T <sub>A</sub> = +100 to +125°C (PACKAGE TYPES D, F, K)	Derate Linearly at 12 mW/°C to 200 mW
POWER DISSIPATION PER OUTPUT TRANSISTOR	
For T <sub>A</sub> = FULL PACKAGE-TEMPERATURE RANGE (All Package Types)	100 mW
OPERATING-TEMPERATURE RANGE (T <sub>A</sub> ):	
PACKAGE TYPES D, F, K, H	-55 to +125°C
PACKAGE TYPE E	-40 to +85°C
STORAGE TEMPERATURE RANGE (T <sub>stg</sub> )	-65 to +150°C
LEAD TEMPERATURE (DURING SOLDERING):	
At distance 1/16 ± 1/32 inch (1.59 ± 0.79 mm) from case for 10 s max.	+265°C

## STATIC ELECTRICAL CHARACTERISTICS

CHARACTER- ISTIC	CONDITIONS			LIMITS AT INDICATED TEMPERATURES (°C)							UNITS
	V <sub>O</sub> (V)	V <sub>IN</sub> (V)	V <sub>DD</sub> (V)	Values at -55, +25, +125 Apply to D, F, K, H Packages				Values at -40, +25, +85 Apply to E Package			
				-55	-40	+85	+125	Min.	Typ.	Max.	
Quiescent Device Current, I <sub>DD</sub> Max.	-	0.5	5	5	5	150	150	-	0.04	5	μA
	-	0.10	10	10	10	300	300	-	0.04	10	
	-	0.15	15	20	20	600	600	-	0.04	20	
	-	0.20	20	100	100	3000	3000	-	0.08	100	
Output Low (Sink) Current I <sub>OL</sub> Min.	0.4	0.5	5	0.64	0.61	0.42	0.36	0.51	1	-	mA
	0.5	0.10	10	1.6	1.5	1.1	0.9	1.3	2.6	-	
	1.5	0.15	15	4.2	4	2.8	2.4	3.4	6.8	-	
Output High (Source) Current, I <sub>OH</sub> Min.	4.6	0.5	5	-0.64	-0.61	-0.42	-0.36	-0.51	-1	-	mA
	2.5	0.5	5	-2	-1.8	-1.3	-1.15	-1.6	-3.2	-	
	9.5	0.10	10	-1.6	-1.5	-1.1	-0.9	-1.3	-2.6	-	
	13.5	0.15	15	-4.2	-4	-2.8	-2.4	-3.4	-6.8	-	
Output Voltage: Low-Level, V <sub>OL</sub> Max.	-	0.5	5	0.05				-	0	0.05	V
	-	0.10	10	0.05				-	0	0.05	
	-	0.15	15	0.05				-	0	0.05	
Output Voltage: High-Level, V <sub>OH</sub> Min.	-	0.5	5	4.95				4.95	5	-	V
	-	0.10	10	9.95				9.95	10	-	
	-	0.15	15	14.95				14.95	15	-	
Input Low Voltage, V <sub>IL</sub> Max.	0.5, 4.5	-	5	1.5				-	-	1.5	V
	1, 9	-	10	3				-	-	3	
	1.5, 13.5	-	15	4				-	-	4	
Input High Voltage, V <sub>IH</sub> Min.	0.5, 4.5	-	5	3.5				3.5	-	-	V
	1, 9	-	10	7				7	-	-	
	1.5, 13.5	-	15	11				11	-	-	
Input Current I <sub>IN</sub> Max.	-	0.18	18	±0.1	±0.1	±1	±1	-	±10 <sup>-5</sup>	±0.1	μA

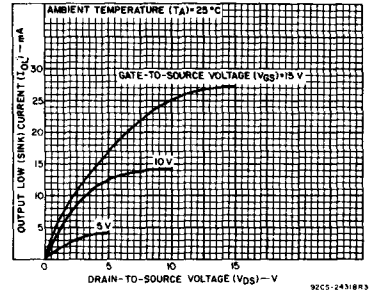

Fig. 1 — Typical output low (sink) current characteristics.

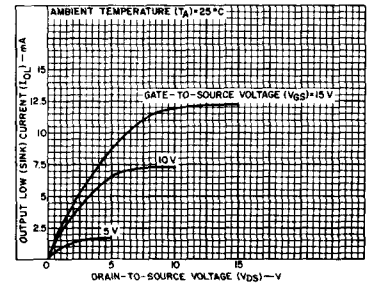

Fig. 2 — Minimum output low (sink) current characteristics.

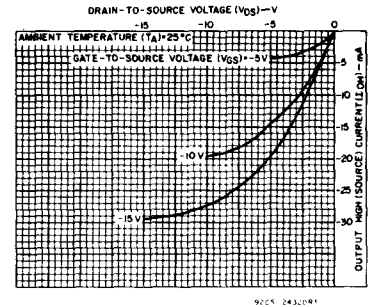

Fig. 3 — Typical output high (source) current characteristics.

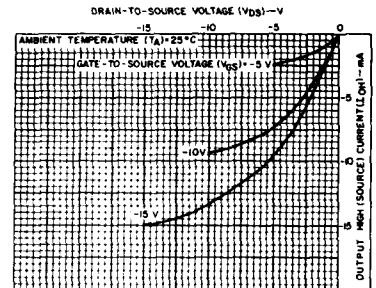

Fig. 4 — Minimum output high (source) current characteristics.

# CD40102B, CD40103B Types

DYNAMIC ELECTRICAL CHARACTERISTICS at  $T_A = 25^\circ\text{C}$ ,  $C_L = 50\text{ pF}$ ,  
 Input  $t_r, t_f = 20\text{ ns}$ ,  $R_L = 200\text{ k}\Omega$

Characteristic	Conditions $V_{DD}$ (V)	Limits All Packages			Units
		Min.	Typ.	Max.	
Propagation Delay Time ( $t_{PHL}, t_{PLH}$ ):					
Clock-to-Output (See Fig. 6)	5	—	300	600	ns
	10	—	130	260	
	15	—	95	190	
Carry In/Counter Enable-to-Output	5	—	200	400	ns
	10	—	90	180	
	15	—	65	130	
Asynchronous Preset Enable-to-Output	5	—	650	1300	ns
	10	—	300	600	
	15	—	200	400	
Clear-to-Output	5	—	375	750	ns
	10	—	180	360	
	15	—	100	200	
Transition Time ( $t_{THL}, t_{TLH}$ )	5	—	100	200	ns
	10	—	50	100	
	15	—	40	80	
Minimum Clock Pulse Width ( $t_{W}$ )	5	—	150	300	ns
	10	—	90	180	
	15	—	40	80	
Minimum $\overline{\text{CLR}}$ Pulse Width ( $t_{W}$ )	5	—	160	320	ns
	10	—	80	160	
	15	—	50	100	
Minimum $\overline{\text{APE}}$ Pulse Width ( $t_{W}$ )	5	—	180	360	ns
	10	—	80	160	
	15	—	60	120	
Minimum $\overline{\text{APE}}$ Removal Time ( $t_{RM}$ )	5	—	110	220	ns
	10	—	50	100	
	15	—	35	70	
Minimum $\overline{\text{SPE}}$ Set-Up Time ( $t_{SU}$ )	5	—	140	280	ns
	10	—	70	140	
	15	—	50	100	
Minimum $\overline{\text{CI}}/\overline{\text{CE}}$ Setup Time ( $t_{SU}$ )	5	—	250	500	ns
	10	—	125	250	
	15	—	75	150	
Minimum $\overline{\text{JAM}}$ Set-Up Time ( $t_{SU}$ ) (Synchronous presetting)	5	—	100	200	ns
	10	—	40	80	
	15	—	30	60	
Maximum Clock Input Frequency ( $f_{CL}$ ) (See Fig. 7)	5	0.7	1.4	—	MHz
	10	1.8	3.6	—	
	15	2.4	4.8	—	
Input Capacitance ( $C_{IN}$ )		—	5	7.5	pF

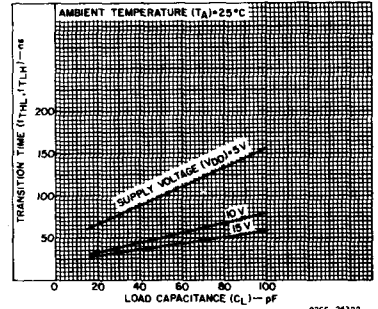

Fig. 5 — Typical transition time as a function of load capacitance.

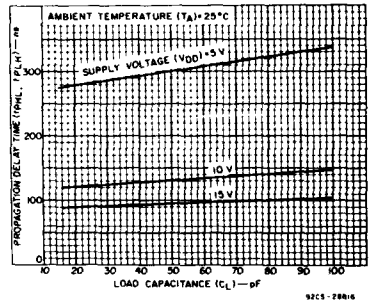

Fig. 6 — Typical propagation delay time as a function of load capacitance (clock to CO/ZD).

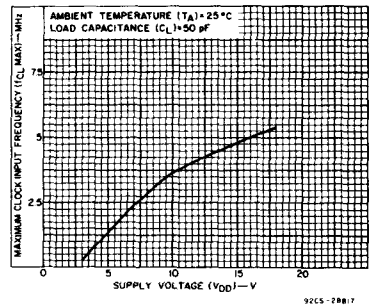

Fig. 7 — Typical maximum clock input frequency as a function of supply voltage.

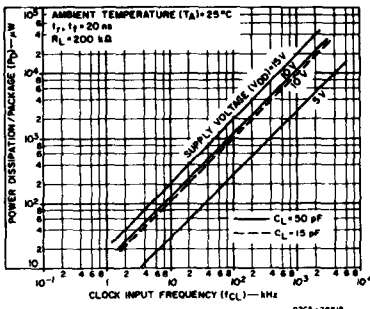

Fig. 8 — Typical dynamic power dissipation as a function of frequency.

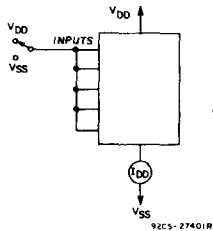

Fig. 9 — Quiescent device current test circuit.

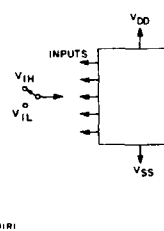

Fig. 10 — Input voltage test circuit.

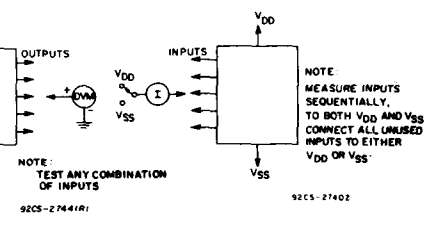

Fig. 11 — Input current test circuit.

# CD40102B, CD40103B Types

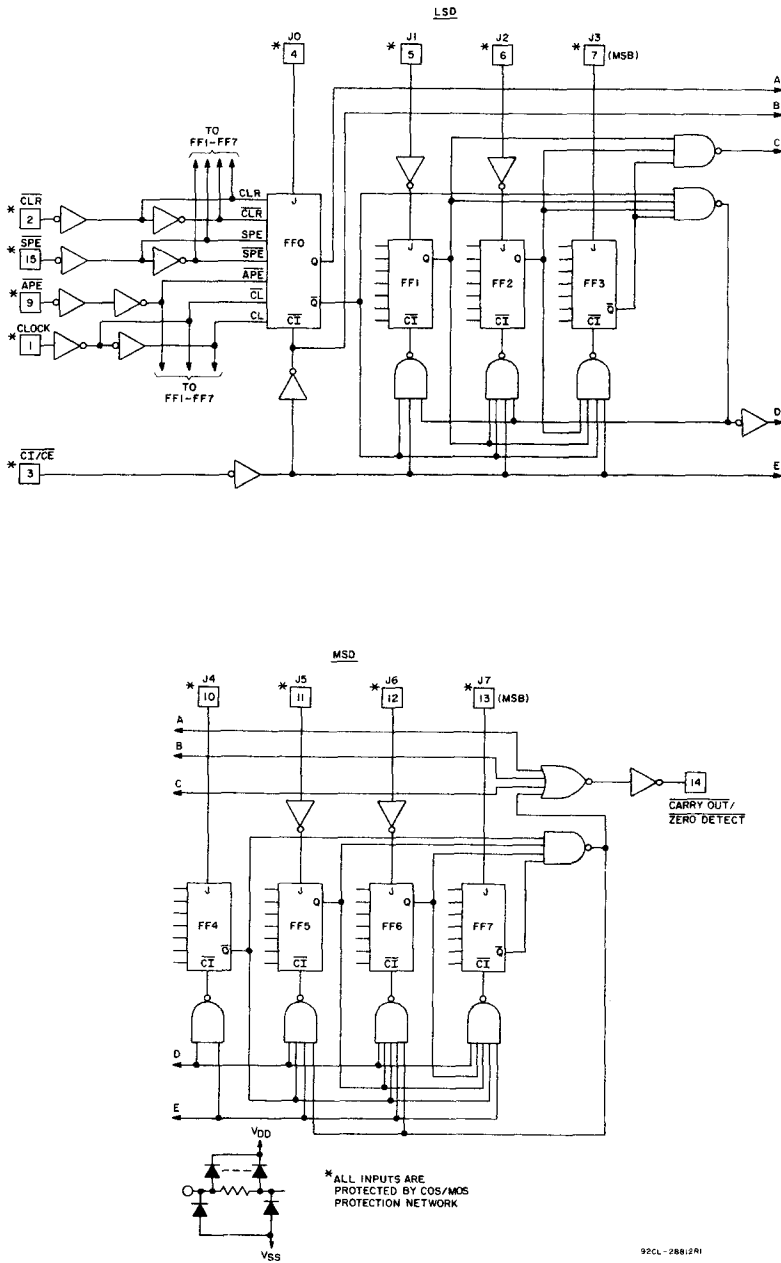

Fig. 12 - Logic diagram for CD40102B.



# CD40102B, CD40103B Types

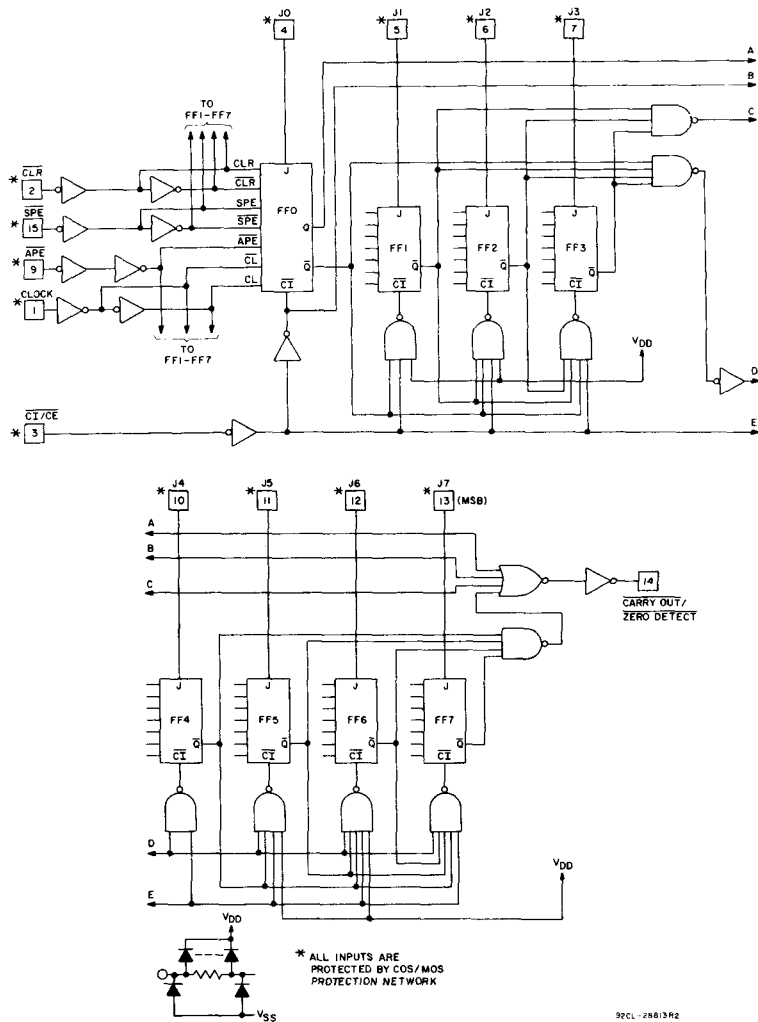

Fig. 13 - Logic diagram for CD40103B.

## TRUTH TABLE

CONTROL INPUTS				PRESET MODE	ACTION
CLR	APE	SPE	CI/CE		
1	1	1	1	Synchronous	Inhibit counter
1	1	1	0		Count down
1	1	0	X		Preset on next positive clock transition
1	0	X	X	Asynchronous	Preset asynchronously
0	X	X	X		Clear to maximum count

Notes: 1. 0 = Low level  
1 = High level  
X = Don't care

- Clock connected to clock input
- Synchronous operation: changes occur on negative-to-positive clock transitions
- JAM inputs: CD40102B BCD: MSD = J7, J6, J5, J4 (J7 is MSB)  
LSD = J3, J2, J1, J0 (J3 is MSB)  
CD40103B Binary: MSB = J7, LSB = J0

# CD40102B, CD40103B Types

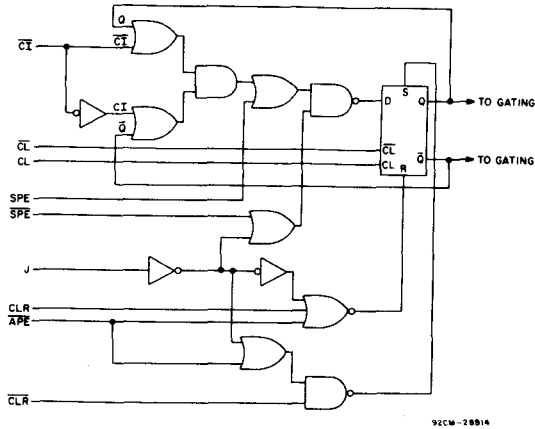

Fig. 14 - Detail logic diagram for flip-flops, FFO - FF7, used in logic diagrams for CD40102B and CD40103B.

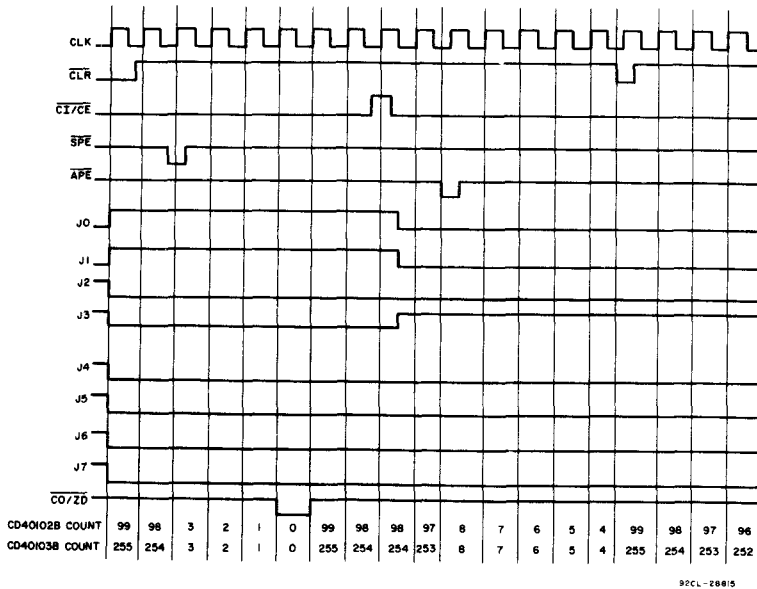
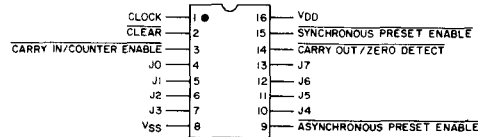

Fig. 15 - Timing diagram for CD40102B and CD40103B.



92CS-2882IR

## CD40102B, CD40103B TERMINAL ASSIGNMENT

# CD40102B, CD40103B Types

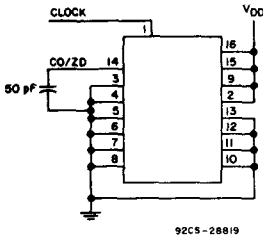

Fig. 16 - Maximum clock frequency test circuit.

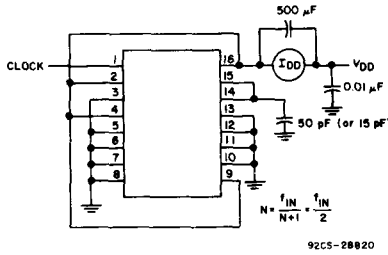

Fig. 17 - Dynamic power dissipation test circuit ( $f \geq 2$  mode).

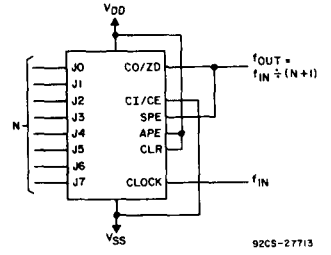

Fig. 18 - Divide-by-"N" counter.

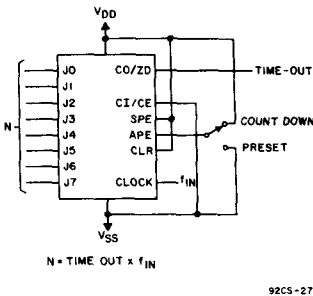

Fig. 19 - Programmable timer.

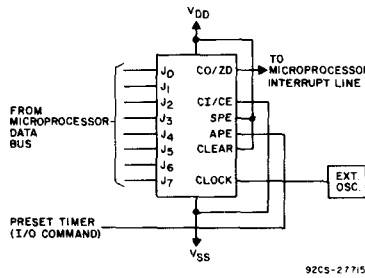
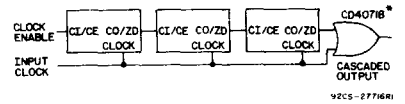

Fig. 20 - Microprocessor interrupt timer.



\* An output spike (160 ns @  $V_{DD} = 5$  V) occurs whenever two or more devices are cascaded in the parallel-clocked mode because the clock-to-carry out delay is greater than the carry-in-to-carry out delay. This spike is eliminated by gating the output of the last device with the clock as shown.

Fig. 21 - Synchronous cascading.

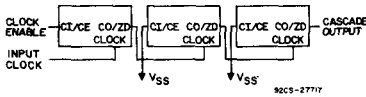
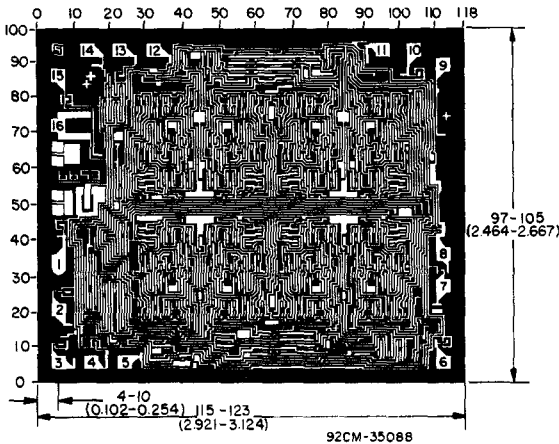

Fig. 22 - Ripple cascading.

Dimensions in parentheses are in millimeters and are derived from the basic inch dimensions as indicated. Grid graduations are in mils ( $10^{-3}$  inch).

The photographs and dimensions of each CMOS chip represent a chip when it is part of the wafer. When the wafer is separated into individual chips, the angle of cleavage may vary with respect to the chip face for different chips. The actual dimensions of the isolated chip, therefore, may differ slightly from the nominal dimensions shown. The user should consider a tolerance of  $-3$  mils to  $+16$  mils applicable to the nominal dimensions shown.

Dimensions and pad layout for CD40102B.



Dimensions and pad layout for CD40103B.

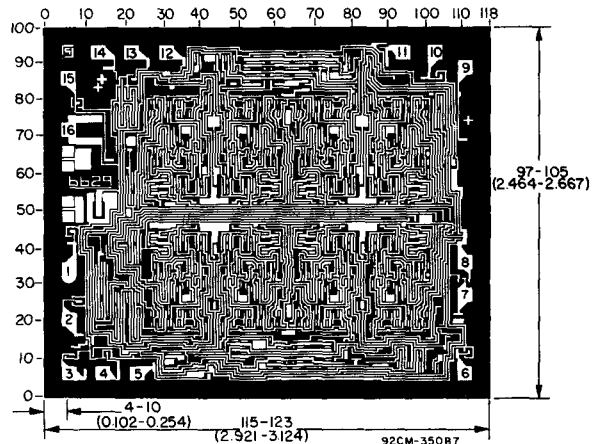

# CD40104B, CD40194B Types

## CMOS 4-Bit Bidirectional Universal Shift Register

High-Voltage Types (20 Volt Rating)

The RCA-CD40104B is a universal shift register featuring parallel inputs, parallel outputs, SHIFT RIGHT and SHIFT LEFT serial inputs, and a high-impedance third output state allowing the device to be used in bus-organized systems.

In the parallel-load mode (S0 and S1 are high), data is loaded into the associated flip-flop and appears at the output after the positive transition of the CLOCK input. During loading, serial data flow is inhibited. Shift-right and shift-left are accomplished synchronously on the positive clock edge with serial data entered at the SHIFT RIGHT and SHIFT LEFT serial inputs, respectively. Clearing the register is accomplished by setting both mode controls low and clocking the register. When the output enable input is low, all outputs assume the high impedance state.

The RCA-CD40194B is a universal shift register featuring parallel inputs, parallel outputs SHIFT RIGHT and SHIFT LEFT serial inputs, and a direct overriding clear input. In the parallel-load mode (S0 and S1 are high), data is loaded into the associated flip-flop and appears at the output after the positive transition of the CLOCK input. During loading, serial data flow is inhibited. Shift right and shift left are accomplished synchronously on the positive clock edge with data entered at the SHIFT RIGHT and SHIFT LEFT serial inputs, respectively. Clocking of the register is inhibited when both mode control inputs are low. When low, the RESET input resets all stages and forces all outputs low.

### Features:

- Medium-speed:  $f_{CL} = 12$  MHz. (typ.) @  $V_{DD} = 10$  V
- Fully static operation
- Synchronous parallel or serial operation
- Three-state outputs (CD40104B)
- Asynchronous master reset (CD40194B)
- Standardized, symmetrical output characteristics
- 5-V, 10-V, and 15-V parametric ratings
- Meets all requirements of JEDEC Tentative Standard No. 13A, "Standard Specifications for Description of 'B' Series CMOS Devices"

### Applications:

- Arithmetic unit bus registers
- Serial/parallel conversions
- General-purpose register for bus-organized systems
- General-purpose registers

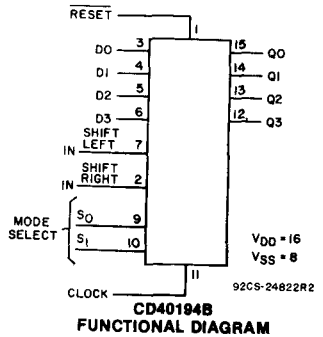
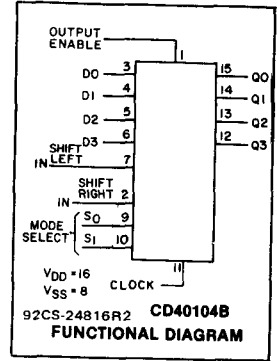

The CD40104B and CD40194B types are supplied in 16-lead ceramic dual-in-line packages (D and F suffixes), 16-lead dual-in-line plastic packages (E suffix), 16-lead ceramic flat packages (K suffix), and in chip form (H suffix).

The CD40194B is similar to industry types 340194 and MC40194.

### MAXIMUM RATINGS, Absolute-Maximum Values:

DC SUPPLY-VOLTAGE RANGE, ( $V_{DD}$ )	
(Voltages referenced to $V_{SS}$ Terminal)	-0.5 to +20 V
INPUT VOLTAGE RANGE, ALL INPUTS	-0.5 to $V_{DD} + 0.5$ V
DC INPUT CURRENT, ANY ONE INPUT	$\pm 10$ mA
POWER DISSIPATION PER PACKAGE ( $P_D$ ):	
For $T_A = -40$ to $+60^\circ\text{C}$ (PACKAGE TYPE E)	500 mW
For $T_A = +60$ to $+85^\circ\text{C}$ (PACKAGE TYPE E)	Derate Linearly at $12 \text{ mW}/^\circ\text{C}$ to 200 mW
For $T_A = -55$ to $+100^\circ\text{C}$ (PACKAGE TYPES D, F, K)	500 mW
For $T_A = +100$ to $+125^\circ\text{C}$ (PACKAGE TYPES D, F, K)	Derate Linearly at $12 \text{ mW}/^\circ\text{C}$ to 200 mW
DEVICE DISSIPATION PER OUTPUT TRANSISTOR:	
For $T_A = \text{FULL PACKAGE-TEMPERATURE RANGE (All Package Types)}$	100 mW
OPERATING-TEMPERATURE RANGE ( $T_A$ ):	
PACKAGE TYPES D, F, K, H	-55 to $+125^\circ\text{C}$
PACKAGE TYPE E	-40 to $+85^\circ\text{C}$
STORAGE TEMPERATURE RANGE ( $T_{stg}$ )	-65 to $+150^\circ\text{C}$
LEAD TEMPERATURE (DURING SOLDERING):	
At distance $1/16 \pm 1/32$ inch ( $1.59 \pm 0.79$ mm) from case for 10 s max.	$+265^\circ\text{C}$

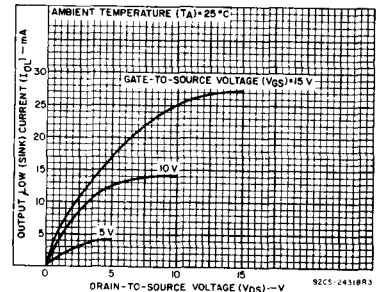

Fig. 1—Typical n-channel output low (sink) current characteristics.

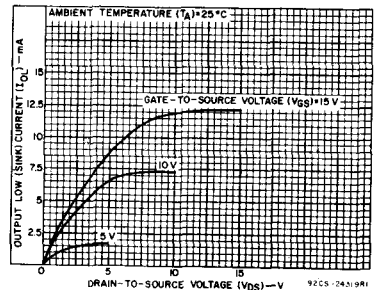

Fig. 2—Minimum n-channel output low (sink) current characteristics.

# CD40104B, CD40194B Types

**RECOMMENDED OPERATING CONDITIONS at  $T_A = 25^\circ\text{C}$ , Except as Noted.**  
**For maximum reliability, nominal operating conditions should be selected so that operation is always within the following ranges:**

CHARACTERISTIC	VDD (V)	LIMITS		UNITS
		Min.	Max.	
Supply-Voltage Range (For Package-Temperature Range)		3	18	V
Setup Time, D0, D3, SR <sub>IN</sub> , SL <sub>IN</sub> to clock $t_s$	5	100	—	
	10	70	—	
	15	50	—	
SELECT 0, SELECT 1 to clock	5	400	—	
	10	220	—	
	15	130	—	
Hold Time, D0, D03, SR <sub>IN</sub> ' SL <sub>IN</sub> to clock $t_H$	5	0	—	ns
	10	0	—	
	15	0	—	
SELECT 0, SELECT 1 to clock	5	0	—	
	10	0	—	
	15	0	—	
Clock Pulse Width, $t_W$	5	180	—	
	10	80	—	
	15	50	—	
Clock Input Frequency $f_{CL}$	5	—	3	MHz
	10	—	6	
	15	—	8	
Clock Input Rise or Fall Time, $t_{rCL}, t_{fCL}$	5	1000	—	$\mu\text{s}$
	10	100	—	
	15	100	—	
Reset Pulse Width, * $t_{WR}$	5	300	—	ns
	10	200	—	
	15	140	—	

\* For CD40194B series only.

**CONTROL TRUTH TABLE FOR CD40194B SERIES**

CLOCK <sup>A</sup>	MODE SELECT		OUTPUT ENABLE	ACTION
	S <sub>0</sub>	S <sub>1</sub>		
	0	0	1	Reset
	1	0	1	Shift right (Q <sub>0</sub> toward Q <sub>3</sub> )
	0	1	1	Shift left (Q <sub>3</sub> toward Q <sub>0</sub> )
	1	1	1	Parallel load
X	X	X	0	Operations occur as shown above, but outputs assume high impedance

**CONTROL TRUTH TABLE FOR CD40194B SERIES**

CLOCK	MODE SELECT		RESET	ACTION
	S <sub>0</sub>	S <sub>1</sub>		
X	0	0	1	No Change
	1	0	1	Shift Right (Q <sub>0</sub> toward Q <sub>3</sub> )
	0	1	1	Shift Left (Q <sub>3</sub> toward Q <sub>0</sub> )
	1	1	1	Parallel Load
X	X	X	0	Reset

1 = High level  
 0 = Low level

X = Don't care  
 ▲ = Level change

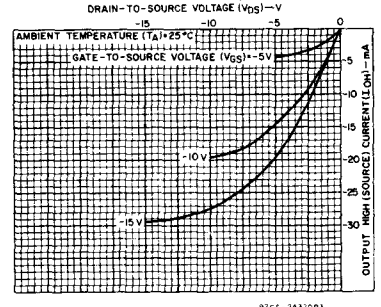

Fig. 3—Typical p-channel output high (source) current characteristics.

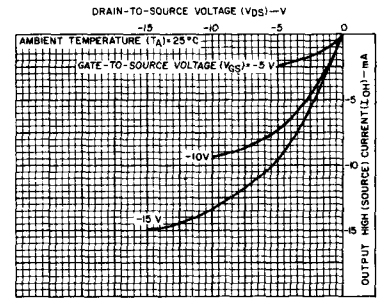

Fig. 4—Minimum p-channel output high (source) current characteristics.

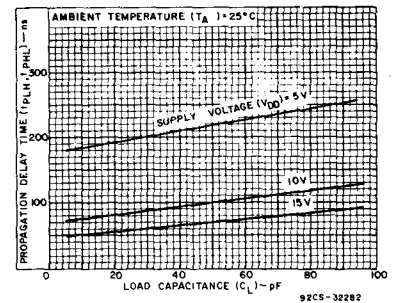

Fig. 5—Typical propagation delay time as a function of load capacitance, (CLOCK to Q).

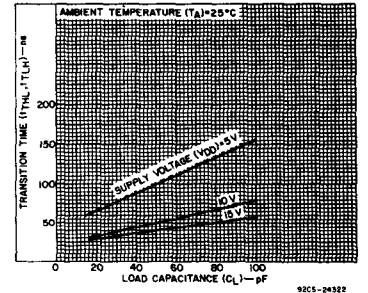

Fig. 6—Typical transition time as a function of load capacitance.

# CD40104B, CD40194B Types

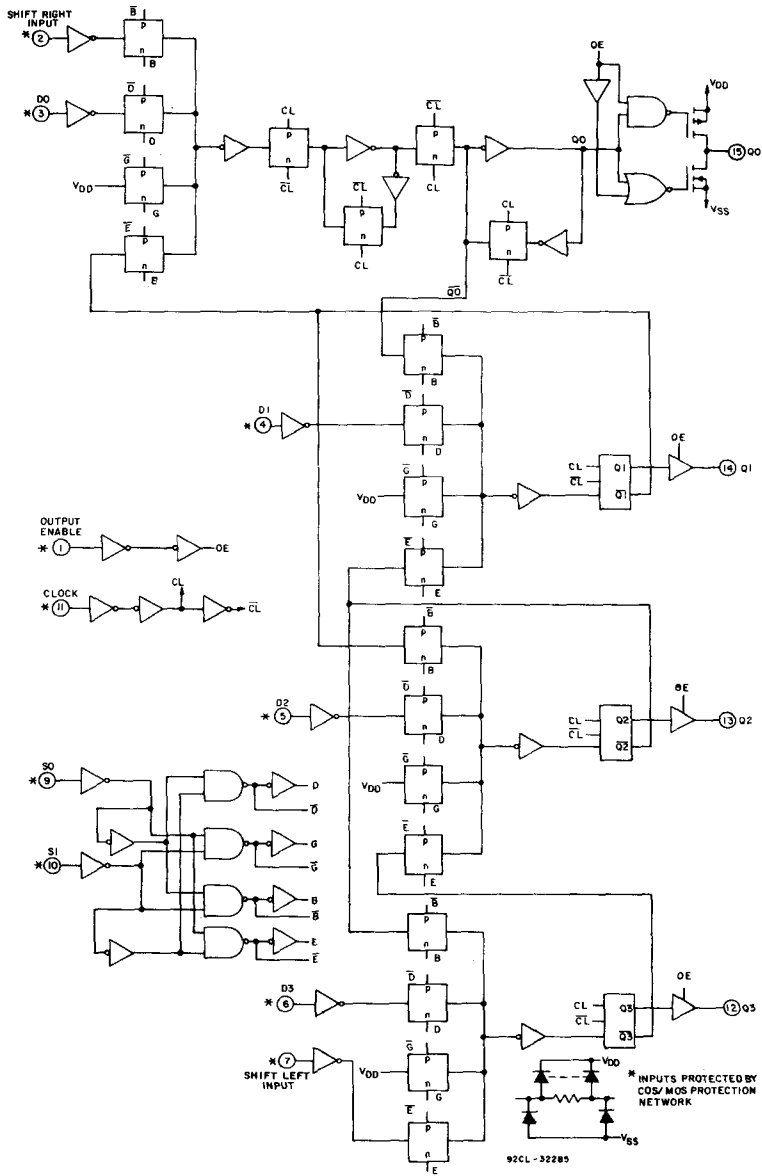

Fig. 7—CD40104B logic diagram.

CD40104B, CD40194B Types

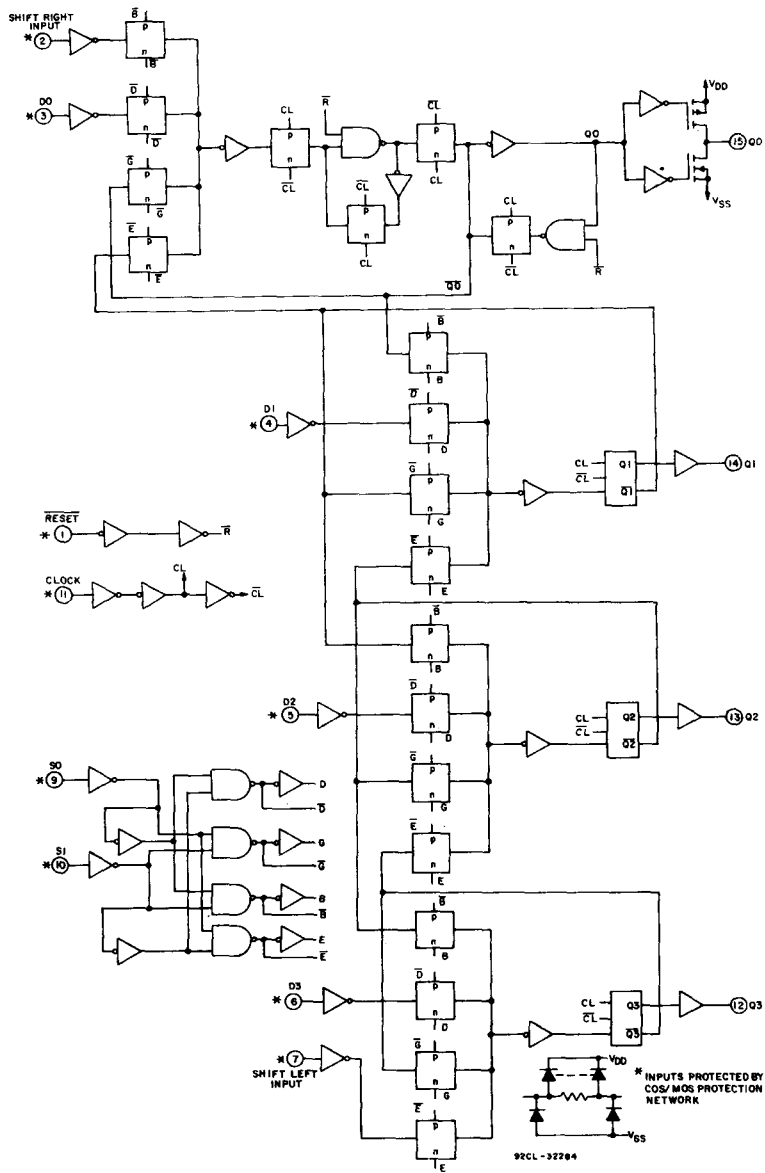

Fig. 8—CD40194B logic diagram.

# CD40104B, CD40194B Types

## STATIC ELECTRICAL CHARACTERISTICS

CHARACTERISTIC	CONDITIONS			LIMITS AT INDICATED TEMPERATURES (°C)							UNITS		
				Values at -55, +25, +125 Apply to D, F, K, H Packages								+25	
				Values at -40, +25, +85 Apply to E Package								Min.	Typ.
$V_O$ (V)	$V_{IN}$ (V)	$V_{DD}$ (V)	-55	-40	+85	+125							
Quiescent Device Current, $I_{DD}$ Max.	—	0,5	5	5	5	150	150	—	0.04	5	$\mu A$		
	—	0,10	10	10	10	300	300	—	0.04	10			
	—	0,15	15	20	20	600	600	—	0.04	20			
Output Low (Sink) Current, $I_{OL}$ Min.	0.4	0,5	5	0.64	0.61	0.42	0.36	0.51	1	—	$\mu A$		
	0.5	0,10	10	1.6	1.5	1.1	0.9	1.3	2.6	—			
	1.5	0,15	15	4.2	4	2.8	2.4	3.4	6.8	—			
Output High (Source) Current, $I_{OH}$ Min.	4.6	0,5	5	-0.64	-0.61	-0.42	-0.36	-0.51	-1	—	mA		
	2.5	0,5	5	-2	-1.8	-1.3	-1.15	-1.6	-3.2	—			
	9.5	0,10	10	-1.6	-1.5	-1.1	-0.9	-1.3	-2.6	—			
Output Voltage: Low-Level, $V_{OL}$ Max.	—	0,5	5	0.05				—	0	0.05	V		
	—	0,10	10	0.05				—	0	0.05			
	—	0,15	15	0.05				—	0	0.05			
Output Voltage: High-Level, $V_{OH}$ Min.	—	0,5	5	4.95				4.95	5	—	V		
	—	0,10	10	9.95				9.95	10	—			
	—	0,15	15	14.95				14.95	15	—			
Input Low Voltage, $V_{IL}$ Max.	0.5, 4.5	—	5	1.5				—	—	1.5	$\mu A$		
	1.9	—	10	3				—	—	3			
	1.5, 13.5	—	15	4				—	—	4			
Input High Voltage, $V_{IH}$ Min.	0.5, 4.5	—	5	3.5				3.5	—	—	$\mu A$		
	1.9	—	10	7				7	—	—			
	1.5, 13.5	—	15	11				11	—	—			
Input Current $I_{IN}$ Max.	—	0,18	18	$\pm 0.1$	$\pm 0.1$	$\pm 1$	$\pm 1$	—	$\pm 10^{-5}$	$\pm 0.1$	$\mu A$		
3-State Output Leakage Current, $I_{OUT}$ Max.	0,18	0,18	18	$\pm 0.4$	$\pm 0.4$	$\pm 12$	$\pm 12$	—	$\pm 10^{-4}$	$\pm 0.4$	$\mu A$		

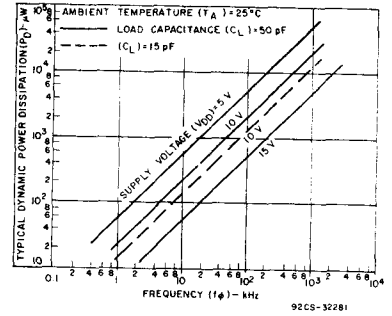

Fig. 9—Typical power dissipation as a function of frequency.

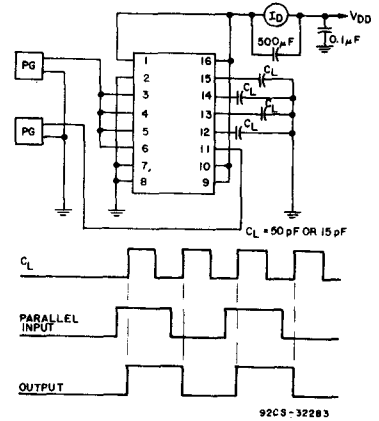

Fig. 10—Dynamic power dissipation test circuit.

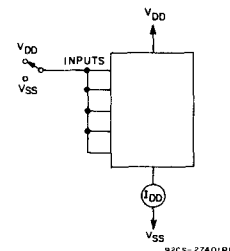

Fig. 11—Quiescent-device-current test circuit.



# CD40104B, CD40194B Types

**DYNAMIC ELECTRICAL CHARACTERISTICS at  $T_A = 25^\circ\text{C}$ ,  
Input  $t_r, t_f = 20\text{ ns}$ ,  $C_L = 50\text{ pF}$ ,  $R_L = 200\text{ k}\Omega$**

CHARACTERISTIC	TEST CONDITIONS	LIMITS			UNITS		
		$V_{DD}$ V	Min.	Typ.		Max.	
Propagation Delay Time: Clock to Q $t_{PHL}, t_{PLH}$		5	—	220	440	ns	
		10	—	100	200		
		15	—	70	140		
3-State Outputs: ■ High Impedance $t_{PZH}, t_{PZL}, t_{PLZ}$		5	—	80	160		
		10	—	35	70		
		15	—	25	50		
$t_{PHZ}$		5	—	45	90		
		10	—	25	50		
		15	—	20	40		
Output Transition Time $t_{THL}, t_{TLH}$		5	—	100	200		
		10	—	50	100		
		15	—	40	80		
Minimum Setup Time: $t_s$ D0, D3, SR <sub>IN</sub> , SL <sub>IN</sub> to Clock		5	—	80	100		ns
		10	—	35	70		
		15	—	20	50		
SELECT 0, SELECT 1 to Clock		5	—	200	400	ns	
		10	—	110	220		
		15	—	65	130		
Minimum Hold Time: $t_H$ D0, D3, SR <sub>IN</sub> , SL <sub>IN</sub> to Clock		5	—	-65	0	ns	
		10	—	-25	0		
		15	—	-15	0		
SELECT 0, SELECT 1 to Clock		5	—	-170	0	ns	
		10	—	-95	0		
		15	—	-55	0		
Minimum Clock Pulse Width $t_W$		5	—	90	180	ns	
		10	—	40	80		
		15	—	25	50		
Maximum Clock Input Frequency $f_{CL}$		5	3	6	—	MHz	
		10	6	12	—		
		15	8	15	—		
Maximum Clock Rise or Fall Time $t_{rCL}, t_{fCL}$		5	—	—	1000	$\mu\text{s}$	
		10	—	—	100		
		15	—	—	100		
Minimum Reset Pulse Width* $t_{WR}$		5	—	150	300	ns	
		10	—	100	200		
		15	—	70	140		
Reset Propagation Delay* $t_{PRHL}$		5	—	230	460	ns	
		10	—	90	180		
		15	—	65	130		
Input Capacitance $C_{IN}$	Any Input	—	5	7.5	pF		

■ For CD40104B series only. \* For CD40194B series only.

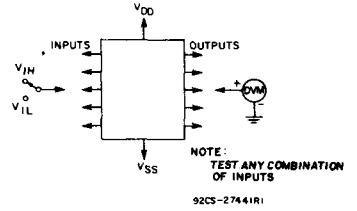

Fig. 12—Input-voltage test circuit.

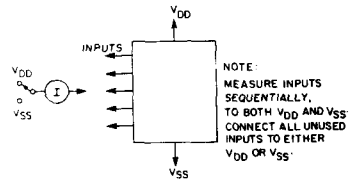
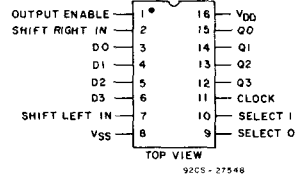

Fig. 13—Input current test circuit.

## TERMINAL DIAGRAMS

### Top View



CD40104B

### Top View

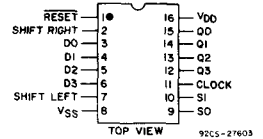

CD40194B

## CD40104B, CD40194B Types

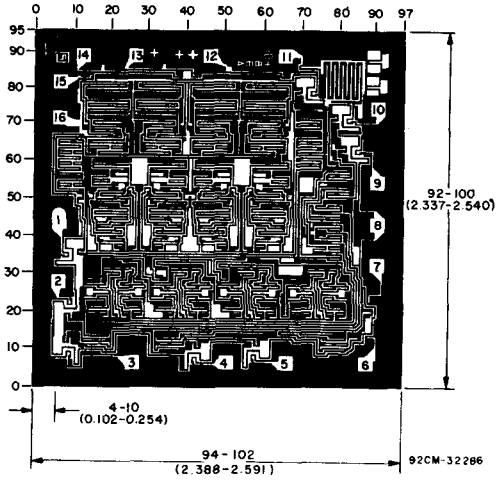

*Dimensions and pad layout for CD40104BH*

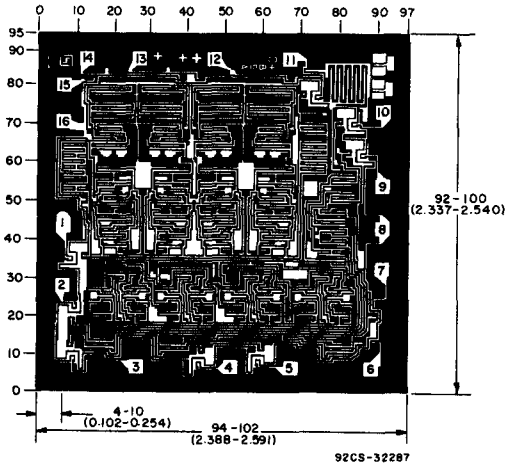

*Dimensions and pad layout for CD40194BH*

*Dimensions in parentheses are in millimeters and are derived from the basic inch dimensions as indicated. Grid graduations are in mils (10<sup>-3</sup> inch).*

*The photographs and dimensions of each CMOS chip represent a chip when it is part of the wafer. When the wafer is separated into individual chips, the angle of cleavage may vary with respect to the chip face for different chips. The actual dimensions of the isolated chip, therefore, may differ slightly from the nominal dimensions shown. The user should consider a tolerance of -3 mils to +16 mils applicable to the nominal dimensions shown.*

## CMOS FIFO Register

4 Bits X 16 Words

High-Voltage Types (20-Volt Rating)

The RCA-CD40105B is a low-power first-in-first-out (FIFO) "elastic" storage register that can store 16 4-bit words. It is capable of handling input and output data at different shifting rates. This feature makes it particularly useful as a buffer between asynchronous systems.

Each word position in the register is clocked by a control flip-flop, which stores a marker bit. A "1" signifies that the position's data is filled and a "0" denotes a vacancy in that position. The control flip-flop detects the state of the preceding flip-flop and communicates its own status to the succeeding flip-flop. When a control flip-flop is in the "0" state and sees a "1" in the preceding flip-flop, it generates a clock pulse that transfers data from the preceding four data latches into its own four data latches and resets the preceding flip-flop to "0". The first and last control flip-flops have buffered outputs. Since all empty locations "bubble" automatically to the input end, and all valid data ripple through to the output end, the status of the first control flip-flop (DATA-IN READY) indicates if the FIFO is full, and the status of the last flip-flop (DATA-OUT READY) indicates if the FIFO contains data. As the earliest data are removed from the bottom of the data stack (the output end), all data entered later will automatically propagate (ripple) toward the output.

**Loading Data** — Data can be entered whenever the DATA-IN READY (DIR) flag is high, by a low to high transition on the SHIFT-IN (SI) input. This input must go low momentarily before the next word is accepted by the FIFO. The DIR flag will go low momentarily, until the data have been trans-

### Features:

- Independent asynchronous inputs and outputs
- 3-state outputs
- Status indicators on input and output
- Standardized, symmetrical output characteristics
- 100% tested for quiescent current at 20 V
- 5-V, 10-V, and 15-V parametric ratings
- Maximum input current of 1  $\mu$ A at 18 V over full package-temperature range; 100 nA at 18 V and 25°C
- Noise margin (over full package-temperature range): 1 V at  $V_{DD} = 5$  V, 2 V at  $V_{DD} = 10$  V, 2.5 V at  $V_{DD} = 15$  V
- Meets all requirements of JEDEC Tentative Standard No. 13A, "Standard Specifications for Description of 'B' Series CMOS Devices"

ferred to the second location. The flag will remain low when all 16-word locations are filled with valid data, and further pulses on the SI input will be ignored until DIR goes high.

**Unloading Data** — As soon as the first word has rippled to the output, DATA-OUT READY (DOR) goes high, and data can be removed by a falling edge on the SO input. This falling edge causes the DOR signal to go low while the word on the output is dumped and the next word moves to the output. As long as valid data are available in the FIFO, the DOR signal will go high again signifying that the next word is ready at the output. When the FIFO is empty, DOR will remain low, and any further commands will be ignored until a "1" marker ripples down to the last control register,

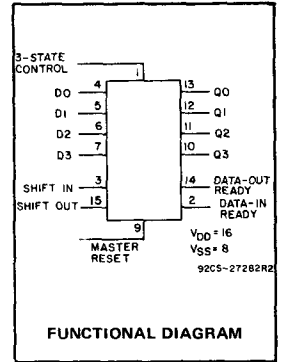

### Applications:

- Bit rate smoothing
- CPU/terminal buffering
- Data communications
- Peripheral buffering
- Line printer input buffers
- Auto dialers
- CRT buffer memories
- Radar data acquisition

when DOR goes high. Unloading of data is inhibited while the 3-state control input is high. The 3-state control signal should not be shifted from high to low (data outputs turned on) while the SHIFT-OUT is at logic 0. This level change would cause the first word to be shifted out (unloaded) immediately and the data to be lost.

**Cascading** — The CD40105B can be cascaded to form longer registers simply by connecting the DIR to SO and DOR to SI. In the cascaded mode, a MASTER RESET pulse must be applied after the supply voltage is turned on. For words wider than 4 bits, the DIR and the DOR outputs must be gated together with AND gates. Their outputs drive the SI and SO inputs in parallel, if expanding is done in both directions (see Figs. 4 and 5).

**3-State Outputs** — In order to facilitate data busing, 3-state outputs are provided on the data output lines, while the load condition of the register can be detected by the state of the DOR output.

**Master Reset** — A high on the MASTER RESET (MR) sets all the control logic marker bits to "0". DOR goes low and DIR goes high. The contents of the data register are not changed, only declared invalid, and will be superseded when the first word is loaded. The shift-in must be low during Master Reset.

The CD40105B types are supplied in 16-lead hermetic dual-in-line ceramic packages (D and F suffixes), 16-lead dual-in-line plastic packages (E suffix), 16-lead ceramic flat packages (K suffix), and in chip form (H suffix).

### MAXIMUM RATINGS, Absolute-Maximum Values:

DC SUPPLY-VOLTAGE RANGE, ( $V_{DD}$ )	
(Voltages referenced to $V_{SS}$ Terminal)	-0.5 to +20 V
INPUT VOLTAGE RANGE, ALL INPUTS	-0.5 to $V_{DD} + 0.5$ V
DC INPUT CURRENT, ANY ONE INPUT	$\pm 10$ mA
POWER DISSIPATION PER PACKAGE ( $P_D$ ):	
For $T_A = -40$ to $+60^\circ\text{C}$ (PACKAGE TYPE E)	500 mW
For $T_A = +60$ to $+85^\circ\text{C}$ (PACKAGE TYPE E)	Derate Linearly at 12 mW/ $^\circ\text{C}$ to 200 mW
For $T_A = -55$ to $+100^\circ\text{C}$ (PACKAGE TYPES D, F, K)	500 mW
For $T_A = +100$ to $+125^\circ\text{C}$ (PACKAGE TYPES D, F, K)	Derate Linearly at 12 mW/ $^\circ\text{C}$ to 200 mW
DEVICE DISSIPATION PER OUTPUT TRANSISTOR	
For $T_A = \text{FULL PACKAGE-TEMPERATURE RANGE (All Package Types)}$	100 mW
OPERATING-TEMPERATURE RANGE ( $T_A$ ):	
PACKAGE TYPES D, F, K, H	-55 to $+125^\circ\text{C}$
PACKAGE TYPE E	-40 to $+85^\circ\text{C}$
STORAGE TEMPERATURE RANGE ( $T_{stg}$ )	-65 to $+150^\circ\text{C}$
LEAD TEMPERATURE (DURING SOLDERING):	
At distance 1/16 $\pm$ 1/32 inch (1.59 $\pm$ 0.79 mm) from case for 10 s max.	$+265^\circ\text{C}$

# CD40105B Types

RECOMMENDED OPERATING CONDITIONS at 25°C, Except as Noted

For maximum reliability, nominal operating conditions should be selected so that operation is always within the following ranges:

CHARACTERISTIC	V <sub>DD</sub> (V)	LIMITS		UNITS
		Min.	Max.	
Supply-Voltage Range (For T <sub>A</sub> = Full Package - Temperature Range)	-	3	18	V
Shift-In or Shift-Out Rate	5	-	1.5	MHz
	10	-	3	
	15	-	4	
Shift-In Pulse Width (Pin 3)	5	200	-	ns
	10	80	-	
	15	60	-	
Shift-Out Pulse Width (Pin 15)	5	180	-	ns
	10	75	-	
	15	55	-	
Shift-In or Shift-Out Rise Time	5	-	15	μs
	10	-	15	
	15	-	15	
Shift-In Fall Time	5	-	15	μs
	10	-	15	
	15	-	15	
Shift-Out Fall Time	5	-	15	μs
	10	-	5	
	15	-	5	
Data Hold Time	5	350	-	ns
	10	150	-	
	15	120	-	
Master Reset Pulse Width	5	220	-	ns
	10	90	-	
	15	60	-	

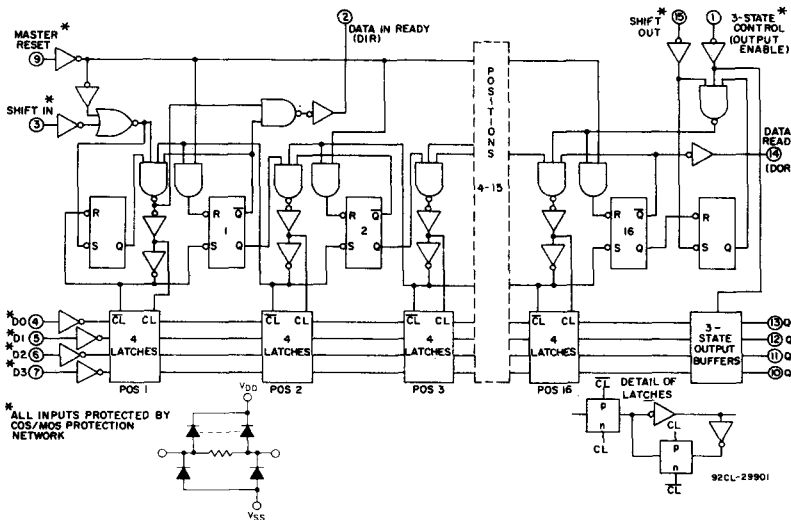

Fig. 1 - Logic diagram for the CD40105B.

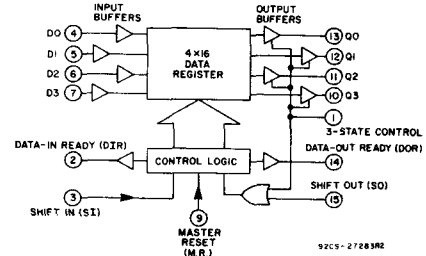
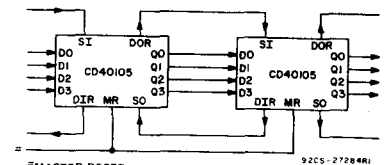

Fig. 2 - CD40105B functional block diagram.



\*MASTER RESET pulse must be applied when cascading by 16 N bits.

Fig. 3 - Expansion, 4-bits wide-by-16 N-bits long.

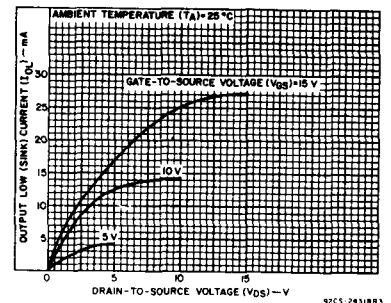

Fig. 4 - Typical output low (sink) current characteristics.

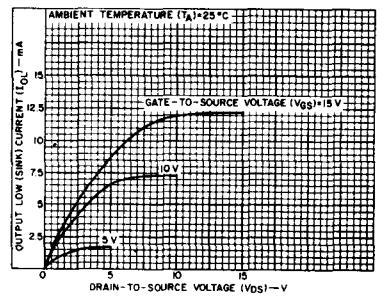

Fig. 5 - Minimum output low (sink) current characteristics.

# CD40105B Types

## STATIC ELECTRICAL CHARACTERISTICS

CHARACTERISTIC	CONDITIONS			LIMITS AT INDICATED TEMPERATURES (°C)							UNITS
				Values at -55, +25, +125 Apply to D, F, K, H, Packages Values at -40, +25, +85 Apply to E Package							
	V <sub>O</sub> (V)	V <sub>IN</sub> (V)	V <sub>DD</sub> (V)	-55	-40	+85	+125	+25			
								Min.	Typ.	Max.	
Quiescent Device Current, I <sub>DD</sub> Max.	-	0,5	5	5	5	150	150	-	0,04	5	μA
	-	0,10	10	10	10	300	300	-	0,04	10	
	-	0,15	15	20	20	600	600	-	0,04	20	
	-	0,20	20	100	100	3000	3000	-	0,08	100	
Output Low (Sink) Current, I <sub>OL</sub> Min.	0,4	0,5	5	0,64	0,61	0,42	0,36	0,51	1	-	mA
	0,5	0,10	10	1,6	1,5	1,1	0,9	1,3	2,6	-	
	1,5	0,15	15	4,2	4	2,8	2,4	3,4	6,8	-	
Output High (Source) Current, I <sub>OH</sub> Min.	4,6	0,5	5	-0,64	-0,61	-0,42	-0,36	-0,51	-1	-	mA
	2,5	0,5	5	-2	-1,8	-1,3	-1,15	-1,6	-3,2	-	
	9,5	0,10	10	-1,6	-1,5	-1,1	-0,9	-1,3	-2,6	-	
	13,5	0,15	15	-4,2	-4	-2,8	-2,4	-3,4	-6,8	-	
Output Voltage: Low-Level, V <sub>OL</sub> Max.	-	0,5	5	0,05			-	0	0,05	-	V
	-	0,10	10	0,05			-	0	0,05	-	
	-	0,15	15	0,05			-	0	0,05	-	
Output Voltage: High-Level, V <sub>OH</sub> Min.	-	0,5	5	4,95			4,95	5	-	-	V
	-	0,10	10	9,95			9,95	10	-	-	
	-	0,15	15	14,95			14,95	15	-	-	
Input Low Voltage, V <sub>IL</sub> Max.	0,5,4,5	-	5	1,5			-	-	1,5	-	V
	1,9	-	10	3			-	-	3	-	
	1,5,13,5	-	15	4			-	-	4	-	
Input High Voltage, V <sub>IH</sub> Min.	0,5,4,5	-	5	3,5			3,5	-	-	-	V
	1,9	-	10	7			7	-	-	-	
	1,5,13,5	-	15	11			11	-	-	-	
Input Current, I <sub>IN</sub> Max.	-	0,18	18	±0,1	±0,1	±1	±1	-	±10 <sup>-5</sup>	±0,1	μA
3-State Output Leakage Current, I <sub>OUT</sub> Max.	0,18	0,18	18	±0,4	±0,4	±12	±12	-	±10 <sup>-4</sup>	±0,4	μA

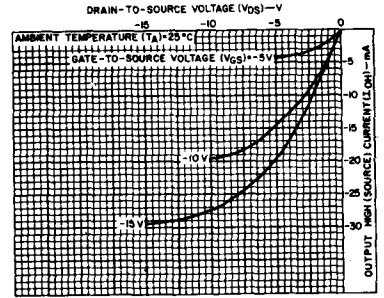

Fig. 6 - Typical output high (source) current characteristics.

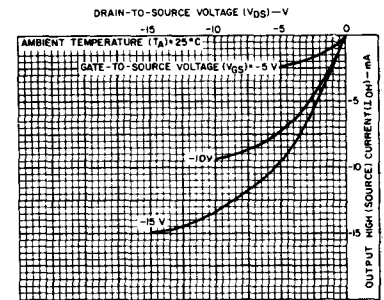

Fig. 7 - Minimum output high (source) current characteristics.

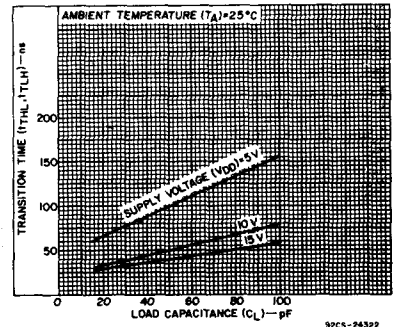

Fig. 8 - Typical transition time as a function of load capacitance.

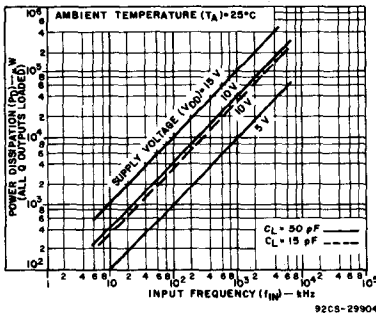

Fig. 9 - Typical dynamic power dissipation as a function of frequency.

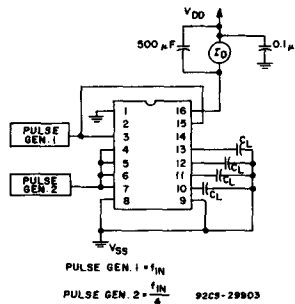

Fig. 10 - Dynamic power dissipation test circuit.

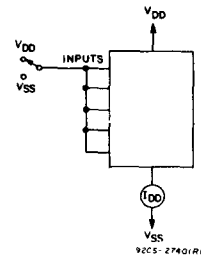

Fig. 11 - Quiescent device current test circuit.

# CD40105B Types

DYNAMIC ELECTRICAL CHARACTERISTICS at  $T_A = 25^\circ\text{C}$ ;  
 Input  $t_r, t_f = 20\text{ ns}$ ,  $C_L = 50\text{ pF}$ ,  $R_L = 200\text{ k}\Omega$

CHARACTERISTIC	TEST CONDITIONS	LIMITS			UNITS	
		$V_{DD}$ (V)	Min.	Typ.		Max.
Propagation Delay Time: Shift-Out or Reset to Data-Out Ready, $t_{PHL}$		5	—	185	370	ns
		10	—	90	180	
		15	—	65	130	
Shift-In to Data-In Ready, $t_{PHL}$		5	—	160	320	ns
		10	—	65	130	
		15	—	45	90	
Shift-Out to $Q_n$ Out, $t_{PHL}, t_{PLH}$		5	—	485	970	ns
		10	—	190	380	
		15	—	125	250	
3-State Control to Data Out $t_{PZH}, t_{PZL}$		5	—	140	280	ns
		10	—	60	120	
		15	—	40	80	
$t_{PHZ}, t_{PLZ}$		5	—	100	200	ns
		10	—	50	100	
		15	—	40	80	
Ripple-Through Delay Input to Output, $t_{PLH}$		5	—	2	4	$\mu\text{s}$
		10	—	1	2	
		15	—	0.7	1.4	
Transition Time, $t_{THL}, t_{TLH}$		5	—	100	200	ns
		10	—	50	100	
		15	—	40	80	
Maximum Shift-In or Shift-Out Rate, $f_I$		5	1.5	3	—	MHz
		10	3	6	—	
		15	4	8	—	
Minimum Shift-In Pulse Width, (Pin 3) $t_W$		5	—	100	200	ns
		10	—	40	80	
		15	—	30	60	
Minimum Shift-Out Pulse Width, (Pin 15) $t_{WL}$		5	—	90	180	ns
		10	—	35	75	
		15	—	25	55	
Maximum Shift-In or Shift-Out Rise Time, $t_r$		5	—	—	15	$\mu\text{s}$
		10	—	—	15	
		15	—	—	15	
Maximum Shift-In Fall Time, $t_f$		5	—	—	15	$\mu\text{s}$
		10	—	—	15	
		15	—	—	15	
Maximum Shift-Out Fall Time, $t_f$		5	—	—	15	$\mu\text{s}$
		10	—	—	5	
		15	—	—	5	
Minimum Data Setup Time, $t_{SU}$		5	—	—	0	ns
		10	—	—	0	
		15	—	—	0	
Minimum Data Hold Time, $t_H$		5	—	175	350	ns
		10	—	75	150	
		15	—	60	120	
Data-In Ready Pulse Width, $t_{WL}$ (Pin 2)		5	—	260	520	ns
		10	—	100	200	
		15	—	70	140	
Data-Out Ready Pulse Width, $t_{WL}$ (Pin 14)		5	—	220	440	ns
		10	—	90	180	
		15	—	65	130	
Minimum Master Reset Pulse Width, $t_{WH}$		5	—	100	200	ns
		10	—	45	90	
		15	—	30	60	
Input Capacitance $C_{IN}$	(Any Input)	—	—	5	7.5	pF

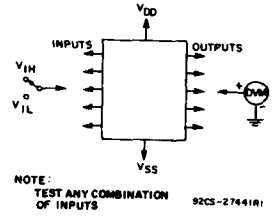

Fig. 12 - Input-voltage test circuit.

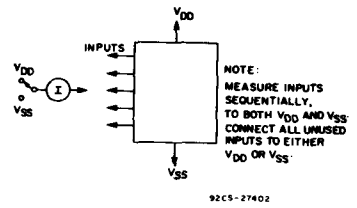
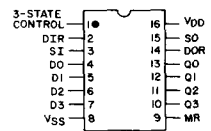

Fig. 13 - Input current test circuit.



92CS-27286R1

### TERMINAL ASSIGNMENT

# CD40105B Types

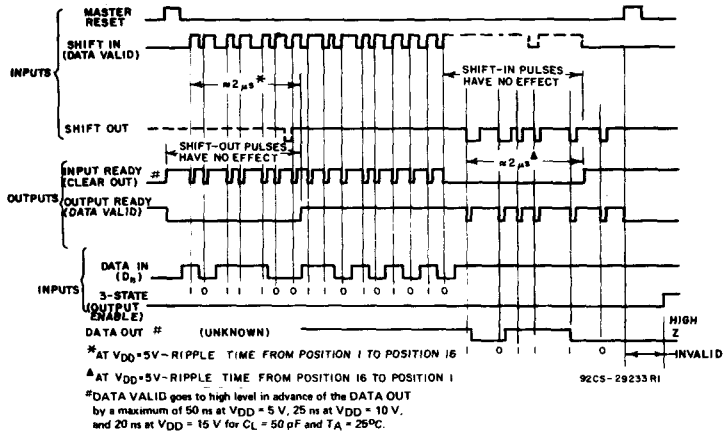

Fig. 14 - Timing diagram for the CD40105B.

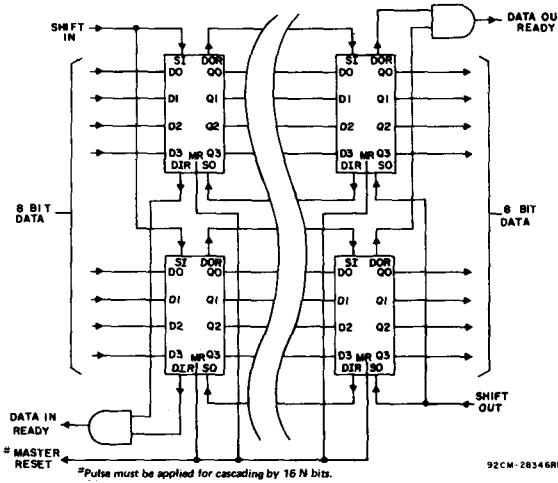
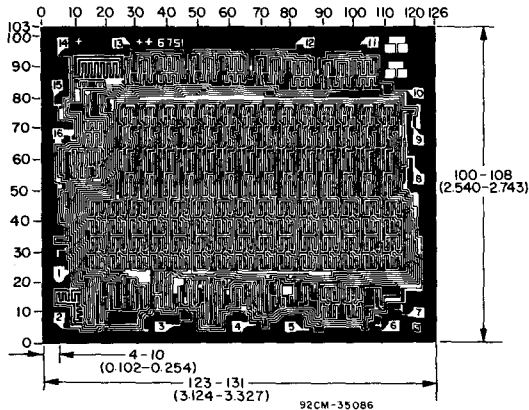

Fig. 15 - Expansion, 8-bits-wide-by-16 N-bits long using CD40105.



Dimension and pad layout for CD40105B.

The photographs and dimensions of each CMOS chip represent a chip when it is part of the wafer. When the wafer is separated into individual chips, the angle of cleavage may vary with respect to the chip face for different chips. The actual dimensions of the isolated chip, therefore, may differ slightly from the nominal dimensions shown. The user should consider a tolerance of  $-3$  mils to  $+16$  mils applicable to the nominal dimensions shown.

Dimensions in parentheses are in millimeters and are derived from the basic inch dimensions as indicated. Grid graduations are in mils ( $10^{-3}$  inch).

# CD40106B Types

## CMOS Hex Schmitt Triggers

High-Voltage Types (20-Volt Rating)

The RCA-CD40106B consists of six Schmitt-trigger circuits. Each circuit functions as an inverter with Schmitt-trigger action on the input. The trigger switches at different points for positive- and negative-going signals. The difference between the positive-going voltage (VP) and the negative-going voltage (VN) is defined as hysteresis voltage (VH) (see Fig. 6). The CD40106B types are supplied in 14-lead hermetic dual-in-line ceramic packages (D and F suffixes), 14-lead dual-in-line plastic package (E suffix), 14-lead ceramic flat package: (K suffix), and in chip form (H suffix).

### Features:

- Schmitt-trigger action with no external components
- Hysteresis voltage (typ.) 0.9 V at VDD = 5 V, 2.3 V at VDD = 10 V, and 3.5 V at VDD = 15 V
- Noise immunity greater than 50%
- No limit on input rise and fall times
- Standardized, symmetrical output characteristics
- 100% tested for quiescent current at 20 V
- Maximum input current of 1 μA at 18 V over full package-temperature range; 100 nA at 18 V and 25°C
- Low VDD to VSS current during slow input ramp
- 5-V, 10-V, and 15-V parametric ratings
- Meets all requirements of JEDEC Tentative Standard No. 13A, "Standard Specifications for Description of 'B' Series CMOS Devices"

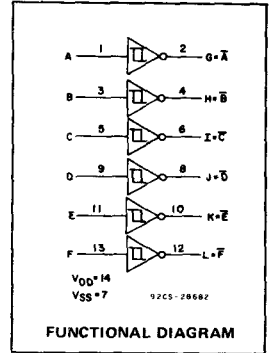

### Applications:

- Wave and pulse shapers
- High-noise-environment systems
- Monostable multivibrators
- Astable multivibrators

### MAXIMUM RATINGS, Absolute-Maximum Values:

DC SUPPLY-VOLTAGE RANGE, (VDD) (Voltages referenced to VSS Terminal)	-0.5 to +20 V
INPUT VOLTAGE RANGE, ALL INPUTS	-0.5 to VDD + 0.5 V
DC INPUT CURRENT, ANY ONE INPUT	±10 mA
POWER DISSIPATION PER PACKAGE (PD):	
For TA = -40 to +60°C (PACKAGE TYPE E)	500 mW
For TA = +60 to +85°C (PACKAGE TYPE E)	Derate Linearly at 12 mW/°C to 200 mW
For TA = -55 to +100°C (PACKAGE TYPES D, F, K)	500 mW
For TA = +100 to +125°C (PACKAGE TYPES D, F, K)	Derate Linearly at 12 mW/°C to 200 mW
DEVICE DISSIPATION PER OUTPUT TRANSISTOR: For TA = FULL PACKAGE-TEMPERATURE RANGE (All Package Types)	100 mW
OPERATING-TEMPERATURE RANGE (TA):	
PACKAGE TYPES D, F, K, H	-55 to +125°C
PACKAGE TYPE E	-40 to +85°C
STORAGE TEMPERATURE RANGE (Tstg)	-65 to +150°C
LEAD TEMPERATURE (DURING SOLDERING): At distance 1/16 ± 1/32 inch (1.59 ± 0.79 mm) from case for 10 s max.	+265°C

### RECOMMENDED OPERATING CONDITIONS

For maximum reliability, nominal operating conditions should be selected so that operation is always within the following ranges:

CHARACTERISTIC	LIMITS		UNITS
	MIN.	MAX.	
Supply Voltage Range (For TA Full Package-Temperature Range)	3	18	V

### DYNAMIC ELECTRICAL CHARACTERISTICS

At TA = 25°C, Input tr, tf = 20 ns, CL = 50 pF, RL = 200 kΩ

CHARACTERISTIC	TEST CONDITIONS	LIMITS		UNITS	
		VDD (V)	TYP.		MAX.
Propagation Delay Time:	tPHL, tPLH	5	140	280	ns
		10	70	140	
		15	60	120	
Transition Time:	tTHL, tTLH	5	100	200	ns
		10	50	100	
		15	40	80	
Input Capacitance, CIN	Any Input		5	7.5	pF

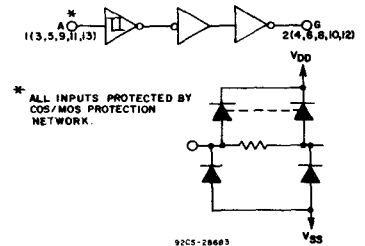

Fig. 1 - Logic diagram (1 of 6 Schmitt triggers).

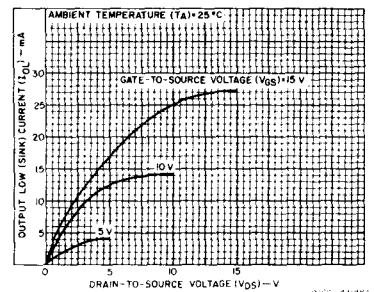

Fig. 2 - Typical output low (sink) current characteristics.

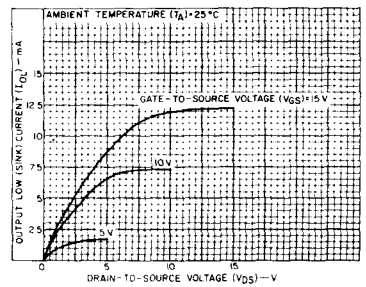

Fig. 3 - Minimum output low (sink) current characteristics.



# CD40106B Types

## STATIC ELECTRICAL CHARACTERISTICS

CHARACTERISTIC	CONDITIONS			LIMITS AT INDICATED TEMPERATURES (°C)							UNITS
	V <sub>O</sub> (V)	V <sub>IN</sub> (V)	V <sub>DD</sub> (V)	Values at -55, +25, +125 Apply to D, F, K, H, Packages				Values at -40, +25, +85 Apply to E Packages			
				-55	-40	+85	+125	+25			
				Min.	Typ.	Max.					
Quiescent Device Current, I <sub>DD</sub> Max.	-	0,5	5	1	1	30	30	-	0,02	1	μA
	-	0,10	10	2	2	60	60	-	0,02	2	
	-	0,15	15	4	4	120	120	-	0,02	4	
	-	0,20	20	20	20	600	600	-	0,04	20	
Positive Trigger Threshold Voltage V <sub>P</sub> Min.	-	-	5	2,2	2,2	2,2	2,2	2,2	2,9	-	V
	-	-	10	4,6	4,6	4,6	4,6	4,6	5,9	-	
	-	-	15	6,8	6,8	6,8	6,8	6,8	8,8	-	
V <sub>P</sub> Max.	-	-	5	3,6	3,6	3,6	3,6	-	2,9	3,6	V
	-	-	10	7,1	7,1	7,1	7,1	-	5,9	7,1	
	-	-	15	10,8	10,8	10,8	10,8	-	8,8	10,8	
Negative Trigger Threshold Voltage V <sub>N</sub> Min.	-	-	5	0,9	0,9	0,9	0,9	0,9	1,9	-	V
	-	-	10	2,5	2,5	2,5	2,5	2,5	3,9	-	
	-	-	15	4	4	4	4	4	5,8	-	
V <sub>N</sub> Max.	-	-	5	2,8	2,8	2,8	2,8	-	1,9	2,8	V
	-	-	10	5,2	5,2	5,2	5,2	-	3,9	5,2	
	-	-	15	7,4	7,4	7,4	7,4	-	5,8	7,4	
Hysteresis Voltage V <sub>H</sub> Min.	-	-	5	0,3	0,3	0,3	0,3	0,3	0,9	-	V
	-	-	10	1,2	1,2	1,2	1,2	1,2	2,3	-	
	-	-	15	1,6	1,6	1,6	1,6	1,6	3,5	-	
V <sub>H</sub> Max.	-	-	5	1,6	1,6	1,6	1,6	-	0,9	1,6	V
	-	-	10	3,4	3,4	3,4	3,4	-	2,3	3,4	
	-	-	15	5	5	5	5	-	3,5	5	
Output Low (Sink) Current, I <sub>OL</sub> Min.	0,4	0,5	5	0,64	0,61	0,42	0,36	0,51	1	-	mA
	0,5	0,10	10	1,6	1,5	1,1	0,9	1,3	2,6	-	
	1,5	0,15	15	4,2	4	2,8	2,4	3,4	6,8	-	
Output High (Source) Current, I <sub>OH</sub> Min.	4,6	0,5	5	-0,64	-0,61	-0,42	-0,36	-0,51	-1	-	mA
	2,5	0,5	5	-2	-1,8	-1,3	-1,15	-1,6	-3,2	-	
	9,5	0,10	10	-1,6	-1,5	-1,1	-0,9	-1,3	-2,6	-	
	13,5	0,15	15	-4,2	-4	-2,8	-2,4	-3,4	-6,8	-	
Output Voltage Low-Level, VOL Max.	-	5	5	0,05				-	0	0,05	V
	-	10	10	0,05				-	0	0,05	
	-	15	15	0,05				-	0	0,05	
Output Voltage High Level, VOH Min.	-	0	5	4,95				4,95	5	-	V
	-	0	10	9,95				9,95	10	-	
	-	0	15	14,95				14,95	15	-	
Input Current, I <sub>IN</sub> Max.	-	0,18	18	±0,1	±0,1	±1	±1	-	±10 <sup>-5</sup>	±0,1	μA

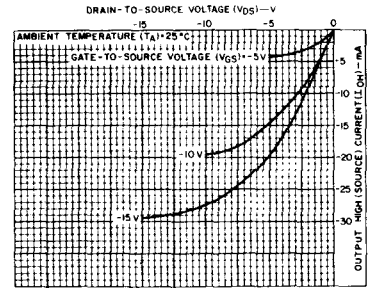

Fig. 4 - Typical output high (source) current characteristics.

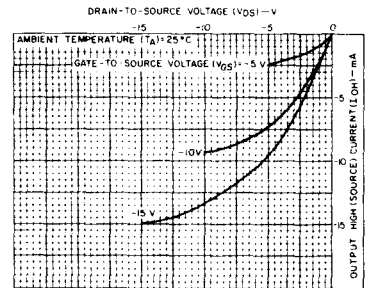

Fig. 5 - Minimum output high (source) current characteristics.

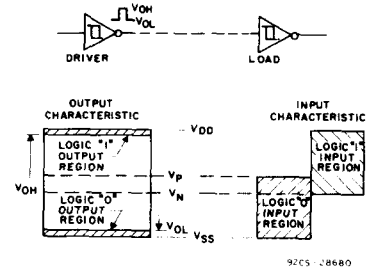
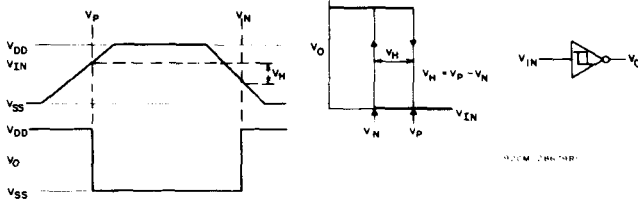

Fig. 7 - Input and output characteristics.



a) Definition of V<sub>P</sub>, V<sub>N</sub>, V<sub>H</sub>

b) Transfer characteristics of 1 of 6 gates

Fig. 6 - Hysteresis definition, characteristics, and test set-up.

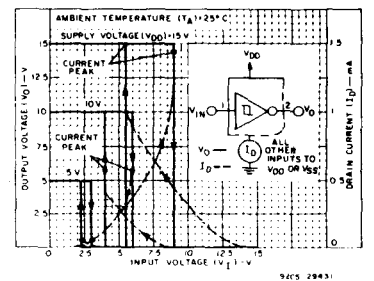

Fig. 8 - Typical current and voltage transfer characteristics.

# CD40106B Types

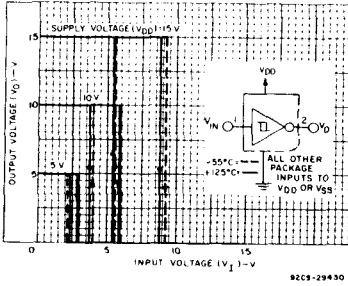

Fig. 9 - Typical voltage transfer characteristics as a function of temperature.

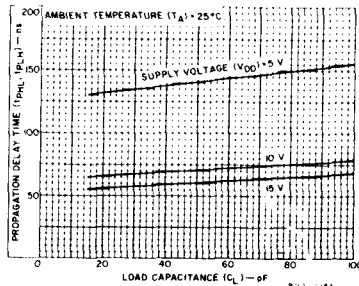

Fig. 10 - Typical propagation delay time as a function of load capacitance.

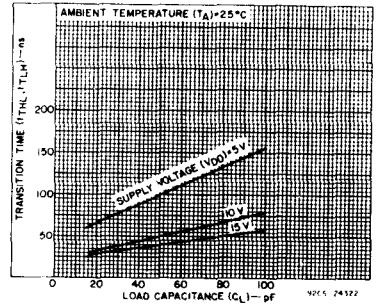

Fig. 11 - Typical transition time as a function of load capacitance.

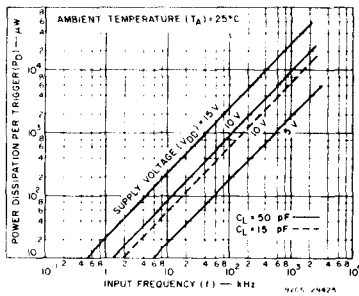

Fig. 12 - Typical power dissipation per trigger as a function of input frequency.

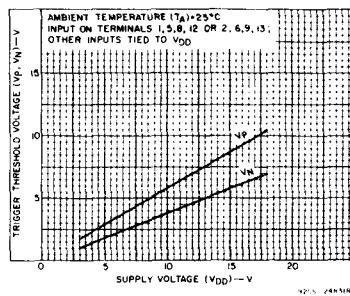

Fig. 13 - Typical trigger threshold voltage as a function of supply voltage.

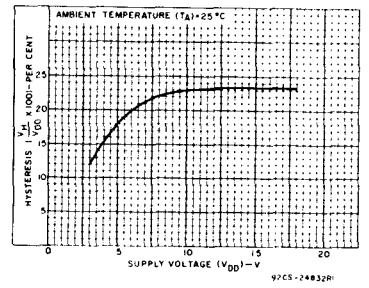

Fig. 14 - Typical per cent hysteresis as a function of supply voltage.

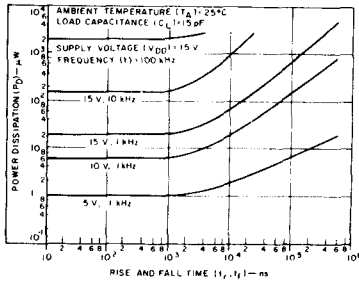

Fig. 15 - Typical power dissipation as a function of rise and fall times.

## APPLICATIONS

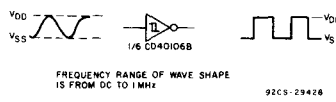

Fig. 16 - Wave shaper.

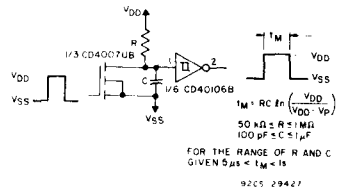

Fig. 17 - Monostable multivibrator.

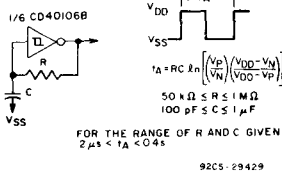

Fig. 18 - Astable multivibrator.

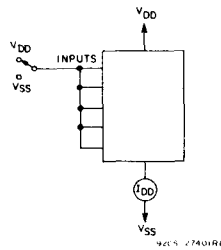

Fig. 19 - Quiescent device current test circuit.

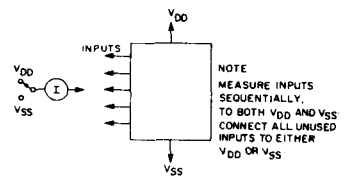

Fig. 20 - Input current test circuit.

# CD40106B Types

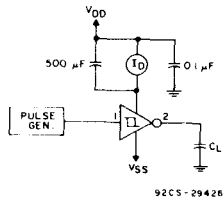
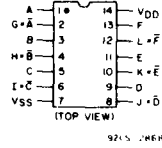
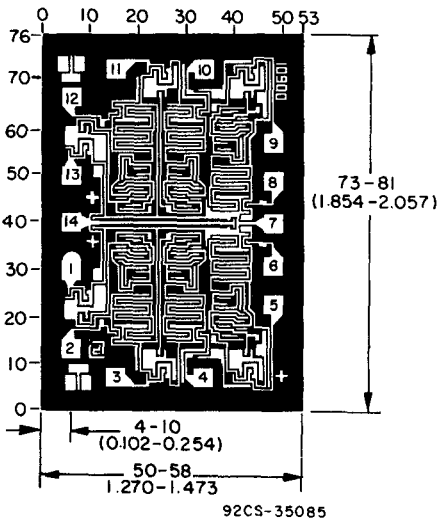

Fig.21 — Dynamic power dissipation test circuit.



TERMINAL ASSIGNMENT



Dimensions in parentheses are in millimeters and are derived from the basic inch dimensions as indicated. Grid graduations are in mils ( $10^{-3}$  inch).

The photographs and dimensions of each CMOS chip represent a chip when it is part of the wafer. When the wafer is separated into individual chips, the angle of cleavage may vary with respect to the chip face for different chips. The actual dimensions of the isolated chip, therefore, may differ slightly from the nominal dimensions shown. The user should consider a tolerance of  $-3$  mils to  $+16$  mils applicable to the nominal dimensions shown.

Dimensions and Pad Layout for CD40106BH

# CD40107B Types

## CMOS Dual 2-Input NAND Buffer/Driver

### High-Voltage Type (20-Volt Rating)

The RCA-CD40107B is a dual 2-input NAND buffer/driver containing two independent 2-input NAND buffers with open-drain single n-channel transistor outputs. This device features a wired-OR capability and high output sink current capability (136 mA typ. at  $V_{DD} = 10\text{ V}$ ,  $V_{DS} = 1\text{ V}$ ). The CD40107B is supplied in the 8-lead dual-in-line plastic (Mini-DIP) package (E suffix), 14-lead hermetic frit-seal ceramic package (F suffix), and in chip form (H suffix).

### Features:

- 32 times standard B-Series output current drive sinking capability — 136 mA typ. @  $V_{DD} = 10\text{ V}$ ,  $V_{DS} = 1\text{ V}$
- 100% tested for quiescent current at 20 V
- Maximum input current of  $1\text{ }\mu\text{A}$  at 18 V over full package-temperature range; 100 nA at 18 V and 25°C
- 5-V, 10-V, and 15-V parametric ratings
- Noise margin, full package temperature range,  $R_L$  to  $V_{DD} = 10\text{ k}\Omega$ :
  - 1 V at  $V_{DD} = 5\text{ V}$
  - 2 V at  $V_{DD} = 10\text{ V}$
  - 2.5 V at  $V_{DD} = 15\text{ V}$
- Meets all requirements of JEDEC Tentative Standard No. 13A, "Standard Specifications for Description of 'B' Series CMOS Devices"

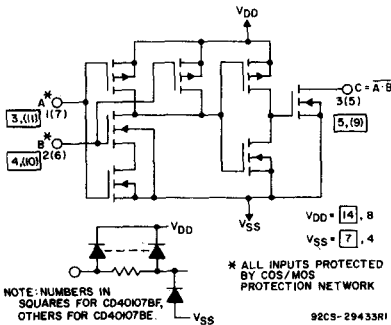
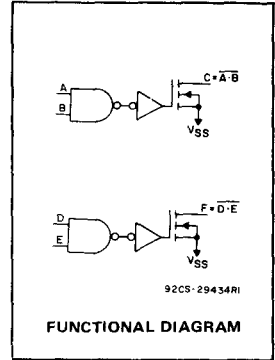

### TRUTH TABLE

A	B	C
0	0	1*
1	0	1*
0	1	1*
1	1	0

\*Requires external pull-up resistor ( $R_L$ ) to  $V_{DD}$ .

#Without pull-up resistor (3-state).

### Applications

- Driving relays, lamps, LEDs
- Line driver
- Level shifter (up or down)

### MAXIMUM RATINGS, Absolute-Maximum Values:

DC SUPPLY-VOLTAGE RANGE, ( $V_{DD}$ ) (Voltages referenced to $V_{SS}$ Terminal)	-0.5 to +20 V
INPUT VOLTAGE RANGE, ALL INPUTS	-0.5 to $V_{DD} + 0.5\text{ V}$
DC INPUT CURRENT, ANY ONE INPUT	$\pm 10\text{ mA}$
POWER DISSIPATION PER PACKAGE ( $P_D$ )	500 mW
DEVICE DISSIPATION PER OUTPUT TRANSISTOR:	
For $T_A = -40$ to $+62.5^\circ\text{C}$ (PACKAGE TYPE E)	250 mW
For $T_A = +62.5$ to $+85^\circ\text{C}$ (PACKAGE TYPE E)	Derate Linearly at $8\text{ mW}/^\circ\text{C}$ to 156 mW
For $T_A = -55$ to $+87.5^\circ\text{C}$ (PACKAGE TYPES F, H)	250 mW
For $T_A = +87.5$ to $+125^\circ\text{C}$ (PACKAGE TYPES F, H)	Derate Linearly at $8\text{ mW}/^\circ\text{C}$ to 94 mW
OPERATING-TEMPERATURE RANGE ( $T_A$ ):	
PACKAGE TYPES F, H	-55 to $+125^\circ\text{C}$
PACKAGE TYPE E	-40 to $+85^\circ\text{C}$
STORAGE TEMPERATURE RANGE ( $T_{stg}$ )	-65 to $+150^\circ\text{C}$
LEAD TEMPERATURE (DURING SOLDERING):	
At distance $1/16 \pm 1/32$ inch ( $1.59 \pm 0.79\text{ mm}$ ) from case for 10 s max.	$+265^\circ\text{C}$

### RECOMMENDED OPERATING CONDITIONS

For maximum reliability, nominal operating conditions should be selected so that operation is always within the following ranges:

CHARACTERISTIC	LIMITS		UNITS
	MIN.	MAX.	
Supply-Voltage Range (For $T_A =$ Full Package-Temperature Range)	3	18	V

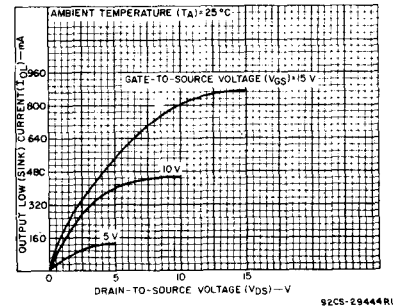

Fig. 2 — Typical output low (sink) current characteristics.

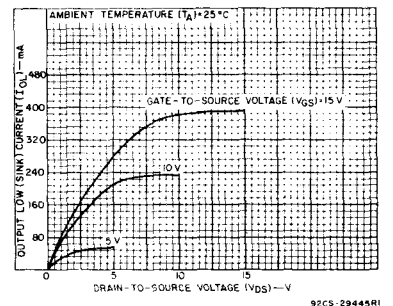

Fig. 3 — Minimum output low (sink) current characteristics.

# CD40107B Types

DYNAMIC ELECTRICAL CHARACTERISTICS at  $T_A = 25^\circ\text{C}$ ,  $C_L = 50\text{ pF}$ , Input  $t_r, t_f = 20\text{ ns}$

CHARACTERISTIC	TEST CONDITIONS	LIMITS		UNITS
		V <sub>DD</sub> Volts	Typ. Max.	
Propagation Delay: High-to-Low, $t_{PHL}$	$R_L^* = 120\ \Omega$	5	100 200	ns
		10	45 90	
		15	30 60	
Low-to-High, $t_{PLH}$	$R_L^* = 120\ \Omega$	5	100 200	ns
		10	60 120	
		15	50 100	
Transition Time: High-to-Low, $t_{THL}$	$R_L^* = 120\ \Omega$	5	50 100	ns
		10	20 40	
		15	10 20	
Low-to-High, $t_{TLH}$	$R_L^* = 120\ \Omega$	5	50 100	ns
		10	35 70	
		15	25 50	
Average Input Capacitance, $C_{IN}$	Any Input	5	7.5	pF
Average Output Capacitance, $C_{OUT}$	Any Output	30	-	pF

\*  $R_L$  is external pull-up resistor to  $V_{DD}$ .

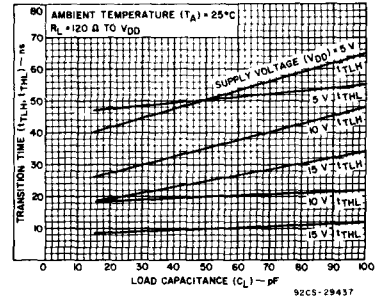

Fig. 4 – Typical transition time as a function of load capacitance.

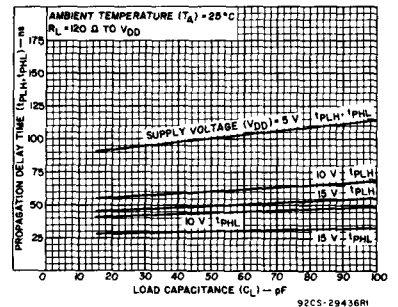

Fig. 5 – Typical propagation delay time as a function of load capacitance.

## STATIC ELECTRICAL CHARACTERISTICS

CHARACTERISTIC	CONDITIONS			LIMITS AT INDICATED TEMPERATURES ( $^\circ\text{C}$ )							UNITS	
	V <sub>O</sub> (V)	V <sub>IN</sub> (V)	V <sub>DD</sub> (V)	Values at -55, +25, +125 Apply to F, H Packages Values at -40, +25, +85 Apply to E Package								
				-55	-40	+85	+125	+25				
								Min.	Typ.	Max.		
Quiescent Device Current $I_{DD}$ Max.	-	0.5	5	1	1	30	30	-	0.02	1	$\mu\text{A}$	
	-	0.10	10	2	2	60	60	-	0.02	2		
	-	0.15	15	4	4	120	120	-	0.02	4		
	-	0.20	20	20	20	600	600	-	0.04	20		
Output Low (Sink) Current $I_{OL}$ Min.	0.4	0.5	5	21	20	14	12	16	32	-	$\text{mA}$	
	1	0.5	5	44	42	30	25	34	68	-		
	0.5	0.10	10	49	46	32	28	37	74	-		
	1	0.10	10	89	85	60	51	68	136	-		
	0.5	0.15	15	66	63	44	38	50	100	-		
Output High (Source) Current $I_{OH}$ Min.	No Internal Pull-Up Device											
Input Low Voltage $V_{IL}$ Max.*	4.5	-	5					1.5	-	-	1.5	$\text{V}$
	9	-	10					3	-	-	3	
	13.5	-	15					4	-	-	4	
Input High Voltage $V_{IH}$ Min.*	0.5, 4.5	-	5					3.5	3.5	-	-	$\text{V}$
	1.9	-	10					7	7	-	-	
	1.5, 13.5	-	15					11	11	-	-	
Input Current $I_{IJN}$ Max.	-	0.18	18	$\pm 0.1$	$\pm 0.1$	$\pm 1$	$\pm 1$	-	$\pm 10^{-5}$	$\pm 0.1$	$\mu\text{A}$	
Output Leakage Current $I_{OZ}$ Max.	18	0.18	18	2	2	20	20	-	$10^{-4}$	2	$\mu\text{A}$	

\* Measured with external pull-up resistor,  $R_L = 10\text{ k}\Omega$  to  $V_{DD}$ .

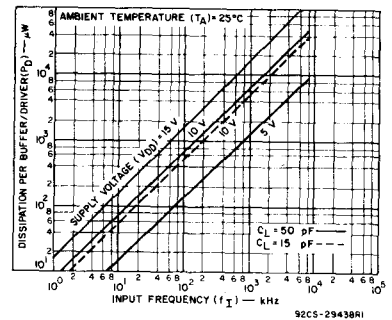

Fig. 6 – Typical power dissipation as a function of input frequency.

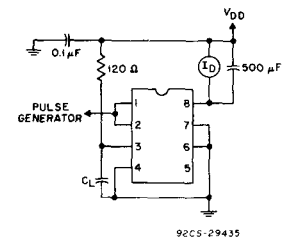
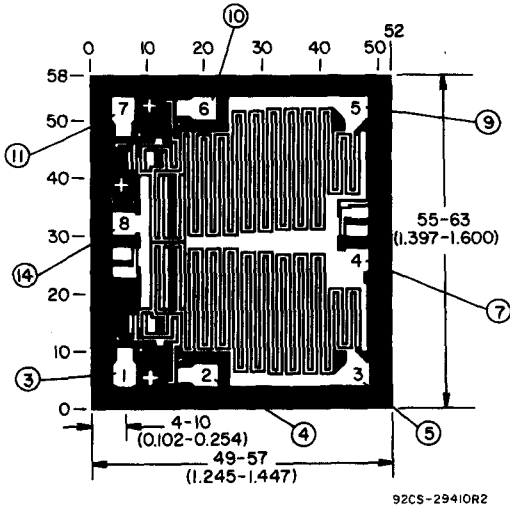

Fig. 7 – Power-dissipation test circuit for CD40107BE.

# CD40107B Types



NOTE: NOS. IN PADS FOR CD40107BE  
NOS. OUTSIDE CHIP FOR CD40107BF

### Dimensions and Pad Layout for CD40107BH.

Dimensions in parentheses are in millimeters and are derived from the basic inch dimensions as indicated. Grid graduations are in mils ( $10^{-3}$  inch).

The photographs and dimensions of each CMOS chip represent a chip when it is part of the wafer. When the wafer is separated into individual chips, the angle of cleavage may vary with respect to the chip face for different chips. The actual dimensions of the isolated chip, therefore, may differ slightly from the nominal dimensions shown. The user should consider a tolerance of  $\pm 3$  mils to  $\pm 16$  mils applicable to the nominal dimensions shown.

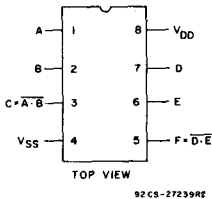

CD40107BE

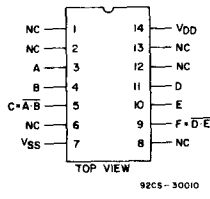

CD40107BF

### TERMINAL ASSIGNMENTS

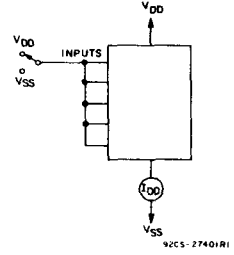

Fig. 8 - Quiescent-device current test circuit.

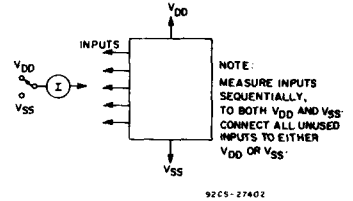

Fig. 9 - Input-current test circuit.

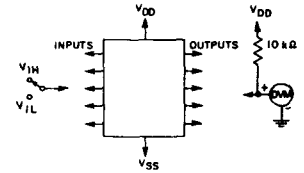

Fig. 10 - Input-voltage test circuit.

### Special Considerations for CD40107B

1. Limiting Capacitive Currents for  $C_L > 500$  pF,  $V_{DD} > 15$  V.

For  $V_{DD} > 15$  V, and load capacitance ( $C_L$ ) from output to ground  $> 500$  pF, an external  $25 \Omega$  series limiting resistor should be inserted between the output terminal and  $C_L$ . No external resistor is necessary if  $C_L < 500$  pF or  $V_{DD} < 15$  V.

2. Driving Inductive Loads

When using the CD40107B to drive inductive loads, the load should be shunted with a diode to prevent high voltages from developing across the CD40107B output.

## CMOS 4 x 4 Multiport Register

High-Voltage Types (20-Volt Rating)

The RCA-CD40108B is a 4 x 4 multiport register containing four 4-bit registers, write address decoder, two separate read address decoders, and two 3-state output buses.

When the ENABLE input is low, the corresponding output bus is switched, independently of the clock, to a high-impedance state. The high-impedance third state provides the outputs with the capability of being connected to the bus lines in a bus-organized system without the need for interface or pull-up components.

When the WRITE ENABLE input is high, all data input lines are latched on the positive transition of the CLOCK and the data is entered into the word selected by the write address lines. When WRITE ENABLE is low, the CLOCK is inhibited and no new data is entered. In either case, the contents of any word may be accessed via the read address lines independent of the state of the CLOCK input.

The CD40108B types are supplied in hermetic 24-lead dual-in-line ceramic packages (D and F suffixes); 24-lead dual-in-line plastic packages (E suffix), 24-lead ceramic flat packages (K suffix), and in chip form (H suffix).

### MAXIMUM RATINGS, Absolute-Maximum Values:

DC SUPPLY-VOLTAGE RANGE, (V <sub>DD</sub> ) (Voltages referenced to V <sub>SS</sub> Terminal)	-0.5 to +20 V
INPUT VOLTAGE RANGE, ALL INPUTS	-0.5 to V <sub>DD</sub> + 0.5 V
DC INPUT CURRENT, ANY ONE INPUT	±10 mA
POWER DISSIPATION PER PACKAGE (P <sub>D</sub> ):	
For T <sub>A</sub> = -40 to +60°C (PACKAGE TYPE E)	500 mW
For T <sub>A</sub> = +60 to +85°C (PACKAGE TYPE E)	Derate Linearly at 12 mW/°C to 200 mW
For T <sub>A</sub> = -55 to +100°C (PACKAGE TYPES D, F, K)	500 mW
For T <sub>A</sub> = +100 to +125°C (PACKAGE TYPES D, F, K)	Derate Linearly at 12 mW/°C to 200 mW
DEVICE DISSIPATION PER OUTPUT TRANSISTOR:	
For T <sub>A</sub> = FULL PACKAGE-TEMPERATURE RANGE (All Package Types)	100 mW
OPERATING-TEMPERATURE RANGE (T <sub>A</sub> ):	
PACKAGE TYPES D, F, K, H	-55 to +125°C
PACKAGE TYPE E	-40 to +85°C
STORAGE TEMPERATURE RANGE (T <sub>stg</sub> )	-65 to +150°C
LEAD TEMPERATURE (DURING SOLDERING):	
At distance 1/16 ± 1/32 inch (1.59 ± 0.79 mm) from case for 10 s max.	+265°C

### TRUTH TABLE

CLOCK	WRITE ENABLE	WRITE 1	WRITE 0	READ 1A	READ 0A	READ 1B	READ 0B	ENABLE A	ENABLE B	D <sub>n</sub>	Q <sub>nA</sub>	Q <sub>nB</sub>
1	1	S1	S2	S1	S2	S1	S2	1	1	1	1	1
1	1	S1	S2	S1	S2	S1	S2	1	1	0	0	0
X	X	X	X	X	X	X	X	0	0	X	Z	Z
1	0	0	0	1	1	0	0	1	1	Q <sub>n</sub> to word 0	Word 1 out	Word 2 out
0	0	0	0	1	1	0	0	1	1	Word 0 not altered	Word 1 out	Word 2 out
X	X	X	X	1	0	0	1	1	1	X	Word 2 out	Word 1 out
1	X	X	X	X	X	X	X	1	1	X	NC	NC

1 HIGH LEVEL, 0 LOW LEVEL, X DON'T CARE, Z HIGH IMPEDANCE  
S1 and S2 refer to input states of either 1 or 0

### Features:

- Four 4-bit registers
- One input and two output buses
- Unlimited expansion in bit and word directions
- Data lines have latched inputs
- 3-state outputs
- Separate control of each bus, allowing simultaneous independent reading of any of four registers on Bus A and Bus B and independent writing into any of the four registers
- CD40108B is pin-compatible with industry type MC14580
- Standardized, symmetrical output characteristics
- 100% tested for quiescent current at 20 V
- Maximum input current of 1 μA at 18 V over full package-temperature range; 100 nA at 18 V and 25°C
- Noise margin (over full package-temperature range):  
1 V at V<sub>DD</sub> = 5 V  
2 V at V<sub>DD</sub> = 10 V  
2.5 V at V<sub>DD</sub> = 15 V
- 5-V, 10-V, and 15-V parametric ratings
- Meets all requirements of JEDEC Tentative Standard No. 13A, "Standard Specifications for Description of 'B' Series CMOS Devices"

### Applications:

- Scratch-pad memories
- Arithmetic units
- Data storage

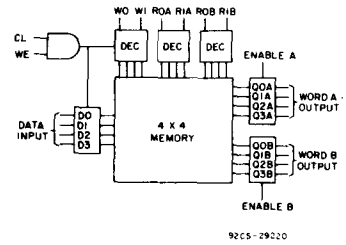
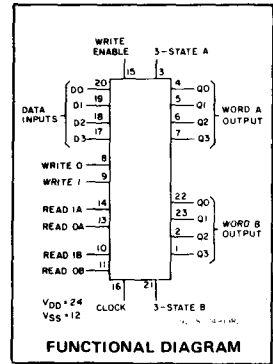

Fig. 1 - Block diagram.

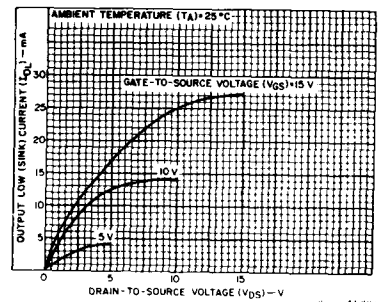

Fig. 2 - Typical output low (sink) current characteristics.

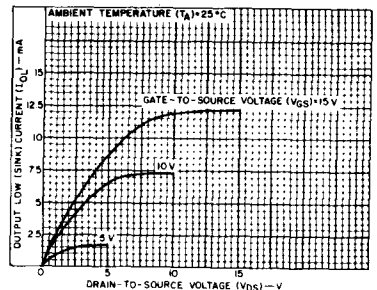

Fig. 3 - Minimum output low (sink) current characteristics.

# CD40108B Types

RECOMMENDED OPERATING CONDITIONS at  $T_A = 25^\circ\text{C}$ , Except as Noted.  
For maximum reliability, nominal operating conditions should be selected so that operation is always within the following ranges:

CHARACTERISTIC	$V_{DD}$ (V)	LIMITS		UNITS
		MIN.	MAX.	
Supply Voltage Range (For $T_A$ = Full Package Temperature Range)	—	3	18	V
Set-Up Time: Data to Clock, $t_{S(D)}$	5 10 15	0 0 0	— — —	ns
Write Enable to $\overline{\text{Clock}}$ , $t_{S(WE)}$	5 10 15	250 100 70	— — —	ns
Write Address to $\overline{\text{Clock}}$ , $t_{S(WA)}$	5 10 15	250 100 70	— — —	ns
Hold Time: Data to Clock, $t_{H(D)}$	5 10 15	220 100 80	— — —	ns
Write Enable to Clock, $t_{H(WE)}$	5 10 15	270 130 80	— — —	ns
Write Address to Clock, $t_{H(WA)}$	5 10 15	330 140 90	— — —	ns
Clock Input Frequency, $f_{CL}$	5 10 15	— — —	1.5 3.5 4.5	MHz
Clock Pulse Width, CL or WE $t_W$	5 10 15	— 130 90	— — —	ns
Clock Rise or Fall Time, $t_{rCL}$ or $t_{fCL}$	5 10 15	— — —	15 5 5	$\mu\text{s}$

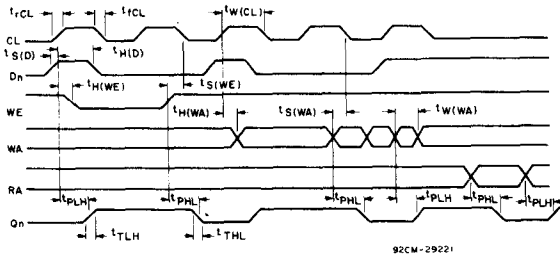

Fig. 4— Timing diagram.

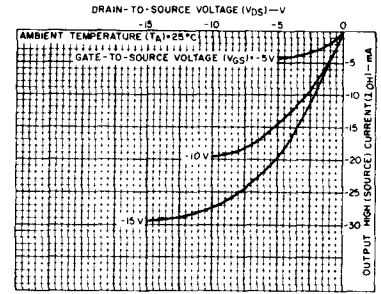

Fig. 5— Typical output high (source) current characteristics.

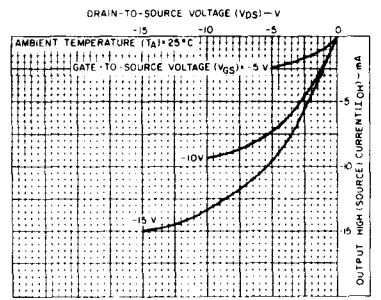

Fig. 6— Minimum output high (source) current characteristics.

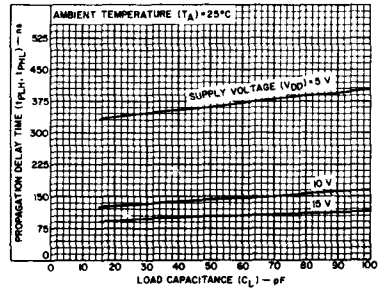

Fig. 7— Typical propagation delay time as a function of load capacitance (CL or WE to Q).

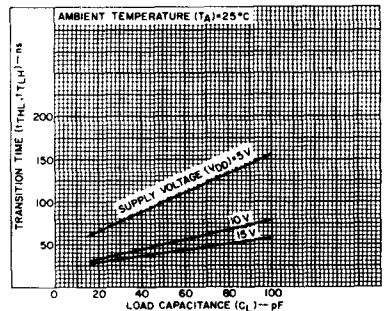

Fig. 8— Typical transition time as a function of load capacitance.



# CD40108B Types

DYNAMIC ELECTRICAL CHARACTERISTICS at  $T_A = 25^\circ\text{C}$ ; Input  $t_r, t_f = 20 \text{ ns}$ ,  $C_L = 50 \text{ pF}$ ,  $R_L = 200 \text{ k}\Omega$

CHARACTERISTIC	$V_{DD}$ (V)	LIMITS			UNITS
		Min.	Typ.	Max.	
Propagation Delay Time:	5	—	360	720	ns
$t_{PHL}$ , $t_{PLH}$	10	—	140	280	
Clock or Write Enable to Q	15	—	100	200	
Read or Write Address to Q	5	—	300	600	ns
	10	—	120	240	
	15	—	85	170	
3-State Disable Delay Time:	5	—	100	200	ns
$t_{PZH}$ , $t_{PHZ}$	10	—	50	100	
$t_{PZL}$ , $t_{PLZ}$	15	—	40	80	
Output Transition Time:	5	—	130	260	ns
$t_{THL}$ , $t_{TLH}$	10	—	60	120	
	15	—	50	100	
Minimum Setup Time:	5	—	-95	0	ns
Data to Clock $t_{S(D)}$	10	—	-35	0	
	15	—	-20	0	
Write Enable to Clock $t_{S(WE)}$	5	—	125	250	ns
	10	—	50	100	
	15	—	35	70	
Write Address to Clock $t_{S(WA)}$	5	—	125	250	ns
	10	—	50	100	
	15	—	35	70	
Clock Rise and Fall Time:	5	—	—	15	$\mu\text{s}$
$t_{rCL}$ , $t_{fCL}$	10	—	—	5	
	15	—	—	5	
Minimum Hold Time:	5	—	110	220	ns
Data to Clock $t_{H(D)}$	10	—	50	100	
	15	—	40	80	
Write Enable to Clock $t_{H(WE)}$	5	—	135	270	ns
	10	—	65	130	
	15	—	40	80	
Write Address to Clock $t_{H(WA)}$	5	—	165	330	ns
	10	—	70	140	
	15	—	45	90	
Maximum Clock Input Frequency, $f_{CL}$	5	1.5	3	—	MHz
	10	3.5	7	—	
	15	4.5	9	—	
Minimum Clock Pulse Width, Clock or Write Enable $t_{W(CL)}$	5	—	175	350	ns
	10	—	65	130	
	15	—	45	90	
Write Address $t_{W(WA)}$	5	—	150	300	ns
	10	—	75	150	
	15	—	45	90	
Average Input Capacitance, (Any Input) $C_I$	—	—	5	7.5	$\text{pF}$

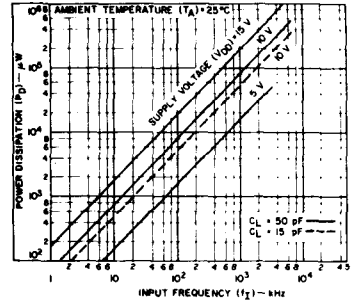

Fig. 9— Typical power dissipation as a function of input frequency.

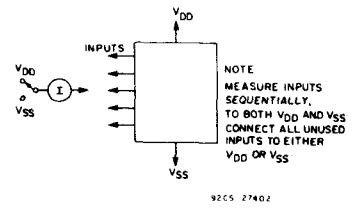

Fig. 10— Input leakage current test circuit.

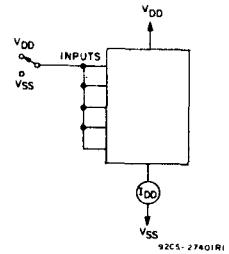

Fig. 11— Quiescent device current test circuit.

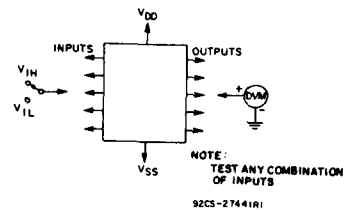
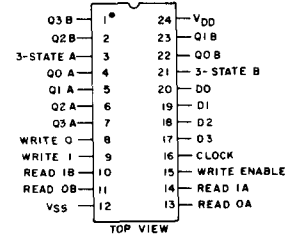

Fig. 12— Input voltage test circuit.

# CD40108B Types

## STATIC ELECTRICAL CHARACTERISTICS

CHARACTER- ISTIC	CONDITIONS			LIMITS AT INDICATED TEMPERATURES (°C)							UNITS				
	V <sub>O</sub> (V)	V <sub>IN</sub> (V)	V <sub>DD</sub> (V)	Values at -55, +25, +125 Apply to D, F, K, H, Packages Values at -40, +25, +85 Apply to E Package											
				-55			-40			+85			+125		
				Min.	Typ.	Max.	Min.	Typ.	Max.	Min.	Typ.	Max.	Min.	Typ.	Max.
Quiescent Device Current, I <sub>DD</sub> Max.	-	0,5	5	5	5	150	150	-	0.04	5	μA				
	-	0,10	10	10	10	300	300	-	0.04	10					
	-	0,15	15	20	20	600	600	-	0.04	20					
	-	0,20	20	100	100	3000	3000	-	0.08	100					
Output Low (Sink) Current I <sub>OL</sub> Min.	0.4	0,5	5	0.64	0.61	0.42	0.36	0.51	1	-	mA				
	0.5	0,10	10	1.6	1.5	1.1	0.9	1.3	2.6	-					
	1.5	0,15	15	4.2	4	2.8	2.4	3.4	6.8	-					
Output High (Source) Current, I <sub>OH</sub> Min.	4.6	0,5	5	-0.64	-0.61	-0.42	-0.36	-0.51	-1	-	mA				
	2.5	0,5	5	-2	-1.8	-1.3	-1.15	-1.6	-3.2	-					
	9.5	0,10	10	-1.6	-1.5	-1.1	-0.9	-1.3	-2.6	-					
	13.5	0,15	15	-4.2	-4	-2.8	-2.4	-3.4	-6.8	-					
Output Voltage: Low-Level, V <sub>OL</sub> Max.	-	0,5	5	0.05			-	0	0.05	V					
	-	0,10	10	0.05			-	0	0.05						
	-	0,15	15	0.05			-	0	0.05						
Output Voltage: High-Level, V <sub>OH</sub> Min.	-	0,5	5	4.95			4.95	5	-	V					
	-	0,10	10	9.95			9.95	10	-						
	-	0,15	15	14.95			14.95	15	-						
Input Low Voltage, V <sub>IL</sub> Max.	0.5, 4.5	-	5	1.5			-	-	1.5	V					
	1, 9	-	10	3			-	-	3						
	1.5, 13.5	-	15	4			-	-	4						
Input High Voltage, V <sub>IH</sub> Min.	0.5, 4.5	-	5	3.5			3.5	-	-	V					
	1, 9	-	10	7			7	-	-						
	1.5, 13.5	-	15	11			11	-	-						
Input Current I <sub>IN</sub> Max.	-	0,18	18	±0.1	±0.1	±1	±1	-	±10 <sup>-5</sup>	±0.1	μA				
3-State Output Leakage Current I <sub>OUT</sub> Max.	0,18	0,18	18	±0.4	±0.4	±12	±12	-	±10 <sup>-4</sup>	±0.4	μA				



92CS-27697

### TERMINAL ASSIGNMENT

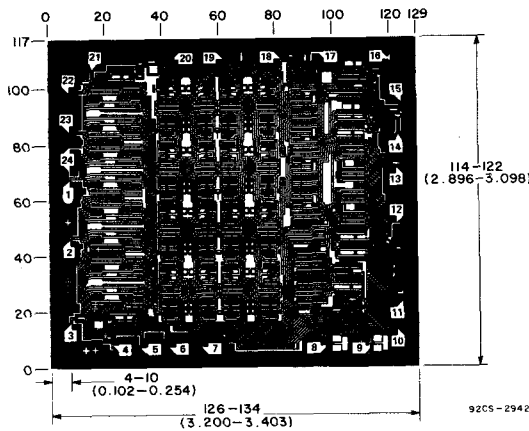

Dimensions in parentheses are in millimeters and are derived from the basic inch dimensions as indicated. Grid graduations are in mils (10<sup>-3</sup> inch).

The photographs and dimensions of each CMOS chip represent a chip when it is part of the wafer. When the wafer is separated into individual chips, the angle of cleavage may vary with respect to the chip face for different chips. The actual dimensions of the isolated chip, therefore, may differ slightly from the nominal dimensions shown. The user should consider a tolerance of -3 mils to +16 mils applicable to the nominal dimensions shown.

Dimensions and Pad Layout for CD40108BH

# CD40108B Types

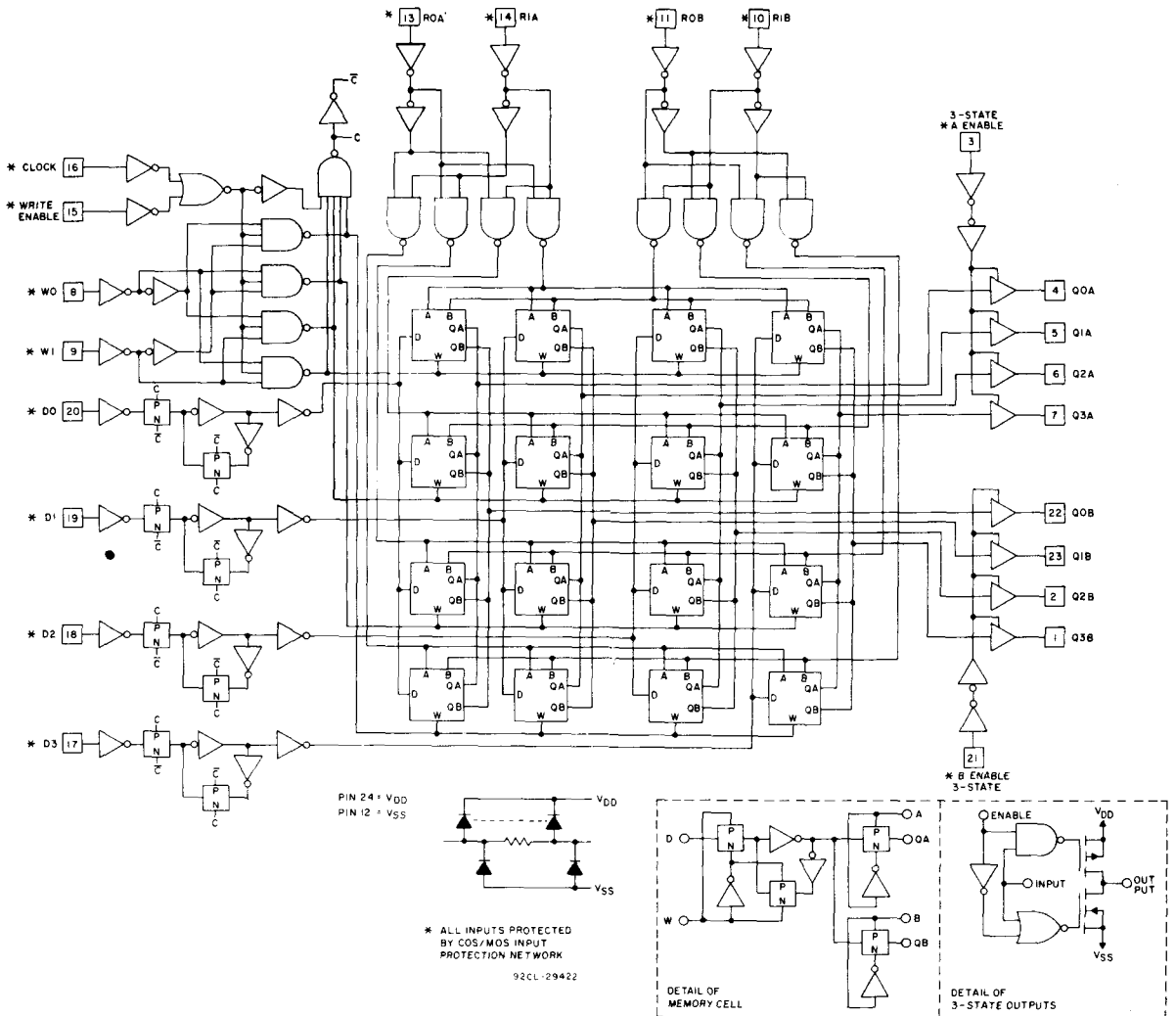

Fig. 13— Schematic diagram

92CL-29422

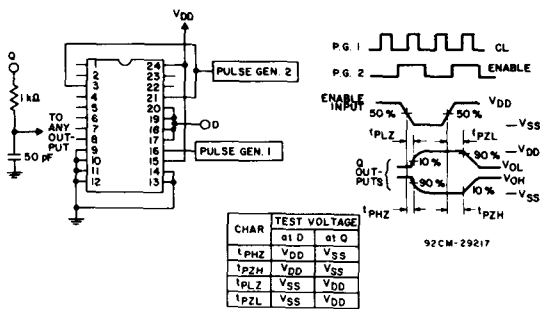

Fig. 14— Output-enable-delay-times test circuit and waveforms.

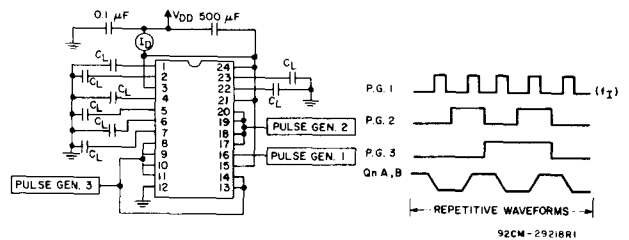

Fig. 15— Power-dissipation test circuit and waveforms.

92CM-29218R1

# CD40109B Types

## CMOS Quad Low-to-High Voltage Level Shifter

### High-Voltage Types (20-Volt Rating)

The RCA-CD40109B contains four low-to-high-voltage level-shifting circuits. Each circuit will shift a low-voltage digital-logic input signal (A, B, C, D) with logical 1 =  $V_{CC}$  and logical 0 =  $V_{SS}$  to a higher-voltage output signal (E, F, G, H) with logical 1 =  $V_{DD}$  and logical 0 =  $V_{SS}$ .

The RCA-CD40109, unlike other low-to-high level-shifting circuits, does not require the presence of the high-voltage supply ( $V_{DD}$ ) before the application of either the low-voltage supply ( $V_{CC}$ ) or the input signals. There are no restrictions on the sequence of application of  $V_{DD}$ ,  $V_{CC}$ , or the input signals. In addition, with one exception there are no restrictions on the relative magnitudes of the supply voltages or input signals within the device maximum ratings, provided that the input signal swings between  $V_{SS}$  and at least 0.7  $V_{CC}$ ;  $V_{CC}$  may exceed  $V_{DD}$ , and input signals may exceed  $V_{CC}$  and  $V_{DD}$ . When operated in the mode  $V_{CC} > V_{DD}$ , the CD40109 will operate as a high-to-low level-shifter.

The CD40109 also features individual three-state output capability. A low level on any of the separately enabled three-state output controls produces a high-impedance state in the corresponding output.

The CD40109B-Series types are supplied in 16-lead ceramic dual-in-line packages (D and F suffixes), 16-lead dual-in-line plastic packages (E suffix), 16-lead ceramic flat packages (K suffix), and in chip form (H suffix).

### Applications:

- High-or-low level-shifting with three-state outputs for unidirectional or bidirectional bussing
- Isolation of logic subsystems using separate power supplies from supply sequencing, supply loss and supply regulation considerations

### Features:

- Independence of power supply sequence considerations— $V_{CC}$  can exceed  $V_{DD}$ , input signals can exceed both  $V_{CC}$  and  $V_{DD}$
- Up and down level-shifting capability
- Three-state outputs with separate enable controls
- Standardized, symmetrical output characteristics
- 100% tested for quiescent current at 20 V
- Maximum input current of 1  $\mu A$  at 18 V over full package-temperature range; 100 nA at 18 V and 25°C
- Noise margin (full package-temperature range)
  - = 1 V at  $V_{CC} = 5 V$ ,  $V_{DD} = 10 V$
  - = 2 V at  $V_{CC} = 10 V$ ,  $V_{DD} = 15 V$
- 5-V, 10-V, and 15-V parametric ratings
- Meets all requirements of JEDEC Tentative Standard No. 13A, "Standard Specifications for Description of 'B' Series CMOS Devices"

### RECOMMENDED OPERATING CONDITIONS

For maximum reliability, nominal operating conditions should be selected so that operation is always within the following ranges:

CHARACTERISTIC	LIMITS		UNITS
	MIN.	MAX.	
Supply-Voltage Range (For $T_A =$ Full Package-Temperature Range)	3	18	V

### MAXIMUM RATINGS, Absolute-Maximum Values:

DC SUPPLY-VOLTAGE RANGE, ( $V_{DD}$ ) (Voltages referenced to $V_{SS}$ Terminal)	-0.5 to +20 V
INPUT VOLTAGE RANGE, ALL INPUTS	-0.5 to $V_{DD} + 0.5 V$
DC INPUT CURRENT, ANY ONE INPUT	$\pm 10 mA$
POWER DISSIPATION PER PACKAGE ( $P_D$ ):	
For $T_A = -40$ to $+60^\circ C$ (PACKAGE TYPE E)	500 mW
For $T_A = +60$ to $+85^\circ C$ (PACKAGE TYPE E)	Derate Linearly at 12 mW/ $^\circ C$ to 200 mW
For $T_A = -55$ to $+100^\circ C$ (PACKAGE TYPES D, F, K)	500 mW
For $T_A = +100$ to $+125^\circ C$ (PACKAGE TYPES D, F, K)	Derate Linearly at 12 mW/ $^\circ C$ to 200 mW
DEVICE DISSIPATION PER OUTPUT TRANSISTOR:	
For $T_A =$ FULL PACKAGE-TEMPERATURE RANGE (All Package Types)	100 mW
OPERATING-TEMPERATURE RANGE ( $T_A$ ):	
PACKAGE TYPES D, F, K, H	-55 to $+125^\circ C$
PACKAGE TYPE E	-40 to $+85^\circ C$
STORAGE TEMPERATURE RANGE ( $T_{stg}$ )	-65 to $+150^\circ C$
LEAD TEMPERATURE (DURING SOLDERING):	
At distance 1/16 $\pm$ 1/32 inch (1.59 $\pm$ 0.79 mm) from case for 10 s max.	$+265^\circ C$

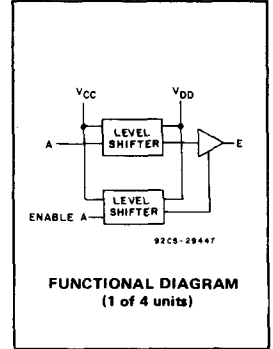

INPUTS		OUTPUTS
A, B, C, D	ENABLE A, B, C, D	E, F, G, H
0	1	0
1	1	1
X	0	Z

LOGIC 0 = LOW ( $V_{SS}$ )    X = DON'T CARE    Z = HIGH IMPEDANCE  
 LOGIC 1 =  $V_{CC}$  at INPUTS and  $V_{DD}$  at OUTPUTS

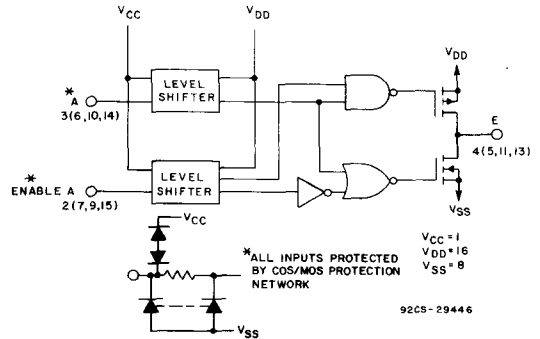

Fig. 1 - CD40109B logic diagram (1 of 4 units).

# CD40109B Types

## STATIC ELECTRICAL CHARACTERISTICS

CHARACTERISTIC	CONDITIONS			LIMITS AT INDICATED TEMPERATURES (°C)						UNITS	
	V <sub>O</sub> (V)	V <sub>IN</sub> (V)	V <sub>DD</sub> (V)	Values at -55, +25, +125 Apply to D, F, K, H Packages Values at -40, +25, +85 Apply to E Package							
				-55	-40	+85	+125	Min.	Typ.		Max.
Quiescent Device Current, I <sub>DD</sub> Max.	-	0,5	5	1	1	30	30	-	0.02	1	μA
	-	0,10	10	2	2	60	60	-	0.02	2	
	-	0,15	15	4	4	120	120	-	0.02	4	
	-	0,20	20	20	20	600	600	-	0.04	20	
Output Low (Sink) Current I <sub>OL</sub> Min.	0.4	0,5	5	0.64	0.61	0.42	0.36	0.51	1	-	mA
	0.5	0,10	10	1.6	1.5	1.1	0.9	1.3	2.6	-	
	1.5	0,15	15	4.2	4	2.8	2.4	3.4	6.8	-	
Output High (Source) Current, I <sub>OH</sub> Min.	4.6	0,5	5	-0.64	-0.61	-0.42	-0.36	-0.51	-1	-	mA
	2.5	0,5	5	-2	-1.8	-1.3	-1.15	-1.6	-3.2	-	
	9.5	0,10	10	-1.6	-1.5	-1.1	-0.9	-1.3	-2.6	-	
	13.5	0,15	15	-4.2	-4	-2.8	-2.4	-3.4	-6.8	-	
Output Voltage: Low-Level, V <sub>OL</sub> Max.	-	0,5	5	0.05				-	0	0.05	V
	-	0,10	10	0.05				-	0	0.05	
	-	0,15	15	0.05				-	0	0.05	
Output Voltage: High-Level, V <sub>OH</sub> Min.	-	0,5	5	4.95				4.95	5	-	V
	-	0,10	10	9.95				9.95	10	-	
	-	0,15	15	14.95				14.95	15	-	
Input Current I <sub>IN</sub> Max.	-	0,18	18	±0.1	±0.1	±1	±1	-	±10 <sup>-5</sup>	±0.1	μA
3-State Output Leakage Current I <sub>OUT</sub> Max.	-	0,18	18	±0.4	±0.4	±12	±12	-	±10 <sup>-4</sup>	±0.4	μA
	V <sub>O</sub> (V)	V <sub>CC</sub> (V)	V <sub>DD</sub> (V)								
Input Low Voltage, V <sub>IL</sub> Max.	1,9	5	10	1.5				-	-	1.5	V
	1.5, 13.5	10	15	3				-	-	3	
Input High Voltage, V <sub>IH</sub> Min.	1,9	5	10	3.5				3.5	-	-	V
	1.5, 13.5	10	15	7				7	-	-	

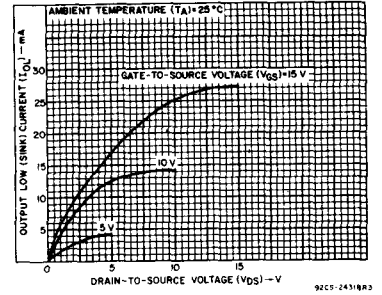

Fig.2 - Typical output low (sink) current characteristics.

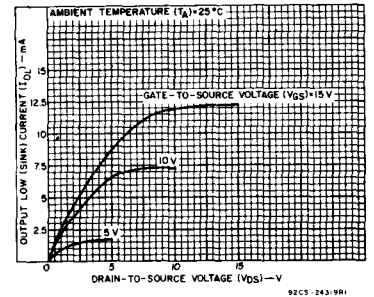

Fig.3 - Minimum output low (sink) current characteristics.

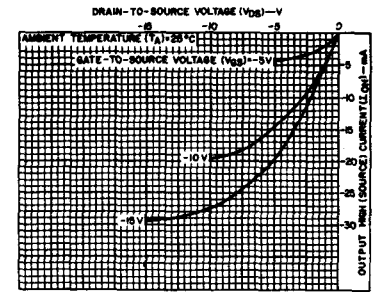

Fig.4 - Typical output high (source) current characteristics.

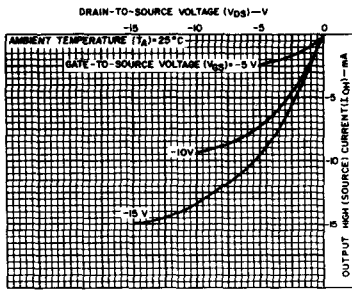

Fig.5 - Minimum output high (source) current characteristics.

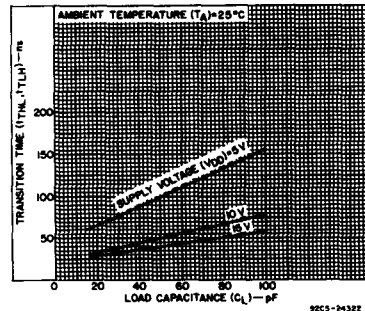

Fig.6 - Typical transition time as a function of load capacitance.

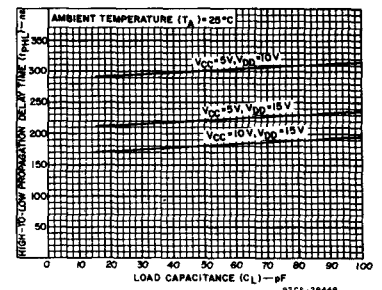

Fig.7 - Typical high-to-low propagation delay time as a function of load capacitance.

# CD40109B Types

DYNAMIC ELECTRICAL CHARACTERISTICS at  $T_A = 25^\circ\text{C}$ , Input  $t_r, t_f = 20\text{ ns}$ ,  $C_L = 50\text{ pF}$ ,  $R_L = 200\text{ k}\Omega$  unless otherwise specified

CHARACTERISTIC	SHIFTING MODE	VCC (V)	VDD (V)	LIMITS		UNITS
				Typ.	Max.	
Propagation Delay - Data Input to Output: High-to-Low Level, $t_{PHL}$	L-H	5	10	300	600	ns
		5	15	220	440	
		10	15	180	360	
	H-L	10	5	250	500	
		15	5	250	500	
		15	10	120	240	
Low-to-High Level, $t_{PLH}$	L-H	5	10	130	260	ns
		5	15	120	240	
		10	15	70	140	
	H-L	10	5	230	460	
		15	5	230	460	
		15	10	80	160	
3-State Disable Delay: $R_L = 1\text{ k}\Omega$ Output High to High Impedance, $t_{PHZ}$	L-H	5	10	60	120	ns
		5	15	75	150	
		10	15	35	70	
	H-L	10	5	200	400	
		15	5	200	400	
		15	10	40	80	
Output Low to High Impedance, $t_{PLZ}$	L-H	5	10	370	740	ns
		5	15	300	600	
		10	15	250	500	
	H-L	10	5	250	500	
		15	5	250	500	
		15	10	130	260	
High Impedance to Output High, $t_{pZH}$	L-H	5	10	320	640	ns
		5	15	230	460	
		10	15	180	360	
	H-L	10	5	300	600	
		15	5	300	600	
		15	10	130	260	
High Impedance to Output Low, $t_{pZL}$	L-H	5	10	100	200	ns
		5	15	80	160	
		10	15	40	80	
	H-L	10	5	200	400	
		15	5	200	400	
		15	10	40	80	
Transition Time, $t_{THL}, t_{TLH}$	L-H	5	10	50	100	ns
		5	15	40	80	
		10	15	40	80	
	H-L	10	5	100	200	
		15	5	100	200	
		15	10	50	100	
Input Capacitance, $C_i$		Any Input		5	7.5	pF

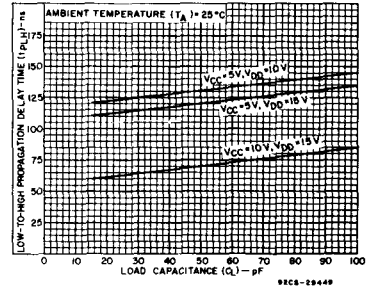

Fig. 8 - Typical low-to-high propagation delay time as a function of load capacitance.

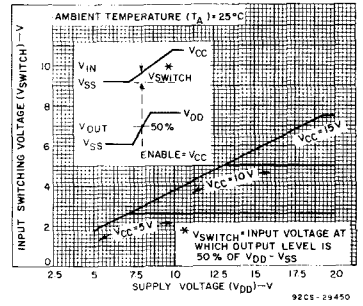

Fig. 9 - Typical input switching as a function of high-level supply voltage.

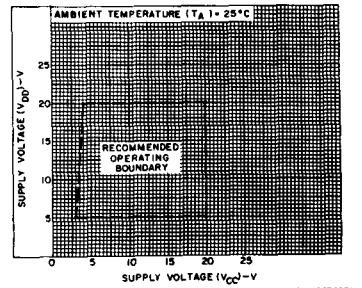

Fig. 10 - High-level supply voltage vs. low-level supply voltage.

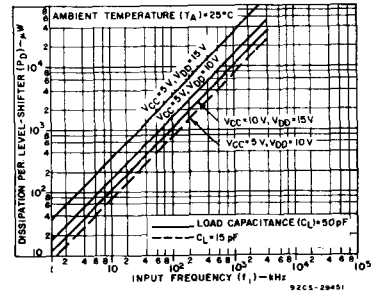

Fig. 11 - Typical dynamic power dissipation as a function of input frequency.

# CD40109B Types

## TEST CIRCUITS

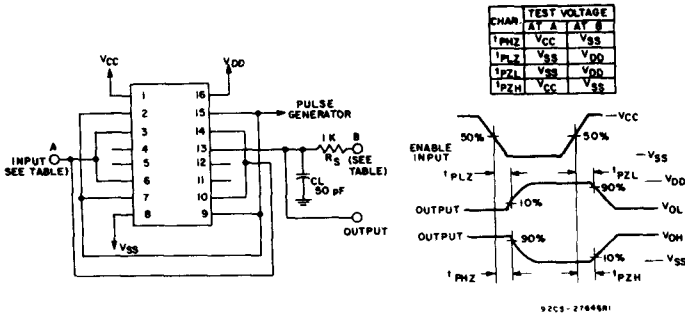

Fig. 12 - Output enable delay times test circuit and waveforms.

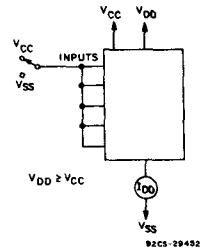

Fig. 13 - Quiescent device current.

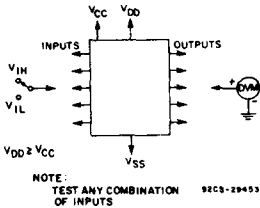

Fig. 14 - Input voltage.

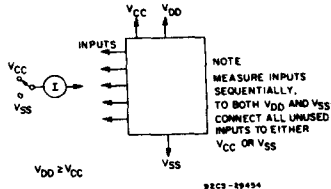

Fig. 15 - Input current.

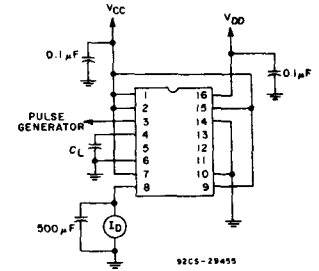
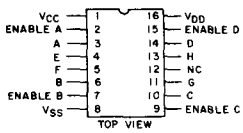

Fig. 16 - Dynamic power dissipation test circuit.



### CD40109B TERMINAL ASSIGNMENT

Dimensions in parentheses are in millimeters and are derived from the basic inch dimensions as indicated. Grid graduations are in mils (10<sup>-3</sup> inch).

The photographs and dimensions of each CMOS chip represent a chip when it is part of the wafer. When the wafer is separated into individual chips, the angle of cleavage may vary with respect to the chip face for different chips. The actual dimensions of the isolated chip, therefore, may differ slightly from the nominal dimensions shown. The user should consider a tolerance of -3 mils to +16 mils applicable to the nominal dimensions shown.

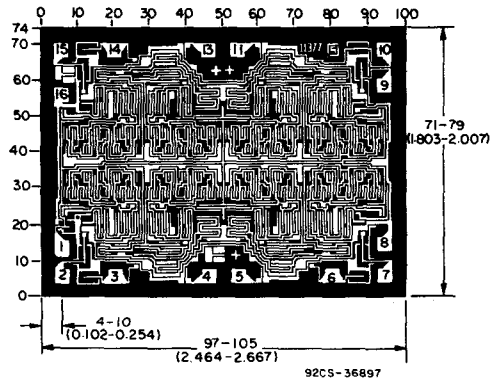

Dimensions and pad layout for CD40109BH.

# CD40110B Types

## CMOS Decade Up-Down Counter/Latch/Display Driver

High-Voltage Type (20-V Rating)



**Features:**

- Separate clock-up and clock-down lines
- Capable of driving common cathode LEDs and other displays directly
- Allows cascading without any external circuitry
- 100% tested for quiescent current at 20 V
- Maximum input current of 1  $\mu$ A at 18 V over full package-temperature range; 100 nA at 18 V and 25° C

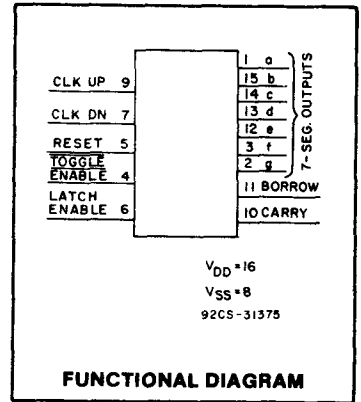

The RCA-CD40110B is a dual-clocked up/down counter with a special preconditioning circuit that allows the counter to be clocked, via positive going inputs, up or down regardless of the state or timing (within 100 ns typ.) of the other clock line.

The clock signal is fed into the control logic and Johnson counter after it is preconditioned. The outputs of the Johnson counter (which include anti-lock gating to avoid being locked at an illegal state) are fed into a latch. This data can be fed directly to the decoder through the latch or can be strobed to hold a particular count while the Johnson counter continues to be clocked. The decoder feeds a seven-segment bipolar output driver which can source up to 25 mA to drive LEDs and other displays such as low-voltage fluorescent and incandescent lamps.

A short duration negative-going pulse appears on the BORROW output when the count changes from 0 to 9 or the CARRY output when the count changes from 9 to 0. At the other times the BORROW and CARRY outputs are a logic 1.

The CARRY and BORROW outputs can be tied directly to the clock-up and clock-down lines respectively of another CD40110B for easy cascading of several counters.

- Noise margin (full package-temperature range) =  
1 V at  $V_{DD} = 5$  V  
2 V at  $V_{DD} = 10$  V  
2.5 V at  $V_{DD} = 15$  V
- 5 V, 10 V and 15 V parametric ratings
- Meets all requirements of JEDEC Tentative Standard No. 13B, "Standard Specifications for Description of 'B' Series CMOS Devices".

**Applications:**

- Rate comparators
- General counting applications where display is desired
- Up-down counting applications where input pulses are random in nature

The CD40110B types are supplied in 16-lead dual-in-line ceramic packages (D and F suffixes), and 16-lead dual-in-line plastic package (E suffix), and also available in chip form, (H suffix).

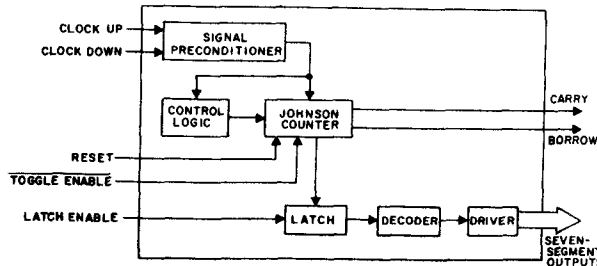

Fig. 1 - Functional diagram.



# CD40110B Types

## MAXIMUM RATINGS, Absolute Maximum Values:

DC SUPPLY-VOLTAGE RANGE, ( $V_{DD}$ ) (Voltages referenced to $V_{SS}$ Terminal)	.....	-0.5 to +20 V
INPUT VOLTAGE RANGE, ALL INPUTS	.....	-0.5 to $V_{DD}$ +0.5 V
DC INPUT CURRENT, ANY ONE INPUT	.....	$\pm 10$ mA
POWER DISSIPATION PER PACKAGE ( $P_D$ ):		
For $T_A = -40$ to $+60^\circ\text{C}$ (PACKAGE TYPE E)	.....	500 mW
For $T_A = +60$ to $+85^\circ\text{C}$ (PACKAGE TYPE E)	.....	Derate Linearly at 12 mW/ $^\circ\text{C}$ to 200 mW
For $T_A = -55$ to $+100^\circ\text{C}$ (PACKAGE TYPES D, F)	.....	500 mW
For $T_A = +100$ to $+125^\circ\text{C}$ (PACKAGE TYPES D, F)	.....	Derate Linearly at 12 mW/ $^\circ\text{C}$ to 200 mW
DEVICE DISSIPATION PER OUTPUT TRANSISTOR		
For $T_A = \text{FULL PACKAGE-TEMPERATURE RANGE}$ (All Package Types)	.....	100 mW
OPERATING-TEMPERATURE RANGE ( $T_A$ ):		
PACKAGE TYPES D, F, H	.....	-55 to $+125^\circ\text{C}$
PACKAGE TYPE E	.....	-40 to $+85^\circ\text{C}$
STORAGE TEMPERATURE RANGE ( $T_{stg}$ )	.....	-65 to $+150^\circ\text{C}$
LEAD TEMPERATURE (DURING SOLDERING):		
At distance $1/16 \pm 1/32$ inch ( $1.59 \pm 0.79$ mm)		
from case for 10 s max.	.....	$+265^\circ\text{C}$

## RECOMMENDED OPERATING CONDITIONS

For maximum reliability, nominal operating conditions should be selected so that operation is always within the following ranges:

CHARACTERISTIC	$V_{DD}$ V	LIMITS		UNITS
		MIN.	MAX.	
Supply-Voltage Range (For $T_A = \text{Full Package Temperature Range}$ )	—	3	18	V
Clock Input Frequency $f_{CL}$ (Sum of $CL_{UP}$ & $CL_{DN}$ Freqs.)	5	—	1	MHz
	10	—	3	
	15	—	5	
Clock Pulse Width $t_w$	5	110	—	ns
	10	40	—	
	15	30	—	
Latch Enable Pulse Width	5	110	—	
	10	30	—	
	15	24	—	
Reset Removal-Time	5	550	—	
	10	200	—	
	15	130	—	
Reset Pulse Width	5	350	—	
	10	170	—	
	15	120	—	

# CD40110B Types

## STATIC ELECTRICAL CHARACTERISTICS

Characteristic	Conditions				Limits at Indicated Temperatures (°C)							Units	
	I <sub>OH</sub> (mA)	V <sub>OH</sub> (V)	V <sub>IN</sub> (V)	V <sub>DD</sub> (V)	Values at -55, +25, +125 for D, F, H Packages				Values at -40, +25, +85 for E Packages				
					-55	-40	+85	+125	+25				
									Min.	Typ.	Max.		
Quiescent Device Current Max. I <sub>DD</sub>	—	—	—	5	5	5	150	150	—	0.04	5	μA	
	—	—	—	10	10	10	300	300	—	0.04	10		
	—	—	—	15	20	20	600	600	—	0.04	20		
	—	—	—	20	100	100	3000	3000	—	0.08	100		
Output Voltage Low-Level Max. V <sub>OL</sub>	—	—	0.5	5	0.05				—	0	0.05	V	
	—	—	0.10	10	0.05				—	0	0.05		
	—	—	0.15	15	0.05				—	0	0.05		
High-Level Min. V <sub>OH</sub>	—	—	0.5	5	—	—	—	—	—	4.55	—	V	
	—	—	0.10	10	—	—	—	—	—	9.55	—		
	—	—	0.15	15	—	—	—	—	—	14.55	—		
Input Low Voltage Max. V <sub>IL</sub>	—	0.5, 3.8	—	5	1.5				—	—	1.5	V	
	—	1, 8.8	—	10	3				—	—	3		
	—	1.5, 13.8	—	15	4				—	—	4		
Input High Voltage Min. V <sub>IH</sub>	—	0.5, 3.8	—	5	3.8				3.5	—	—	V	
	—	1, 8.8	—	10	7				7	—	—		
	—	1.5, 13.8	—	15	11				11	—	—		
7-Segment Outputs Output Drive Voltage, High Min. V <sub>OH</sub>	■	—	—	5	3.9		4	3.9	4.5	—	V		
	-5	—	—		3.65		3.7	3.7	4.3	—			
	-10	—	—		3.55		3.65	3.65	4.25	—			
	-15	—	—		3.5		3.5	3.6	4.15	—			
	-20	—	—		3.45		3.35	3.45	4	—			
	-25	—	—	3.4		3.3	3.4	3.9	—				
	■	—	—	10	8.75		8.85	8.75	9.5	—			
	-5	—	—		8.45		8.55	8.55	9.3	—			
	-10	—	—		8.42		8.5	8.5	9.25	—			
	-15	—	—		8.4		8.47	8.47	9.2	—			
	-20	—	—		8.4		8.40	8.45	9.1	—			
	-25	—	—	8.3		8.25	8.3	9	—				
	■	—	—	15	13.8		13.9	13.8	14.5	—			
	-5	—	—		13.65		13.75	13.75	14.35	—			
	-10	—	—		13.6		13.72	13.72	14.3	—			
-15	—	—	13.6		13.7	13.7	14.2	—					
-20	—	—	13.6		13.6	13.65	14.1	—					
-25	—	—	13.3		13.25	13.3	14.0	—					
7-Segment Outputs Output Low (Sink) Current Min. I <sub>OL</sub>	—	0.4	0.5	5	1.28	1.22	0.84	0.72	1	2	—		
	—	0.5	0.10	10	3.2	3	2.2	1.8	2.6	5.2	—		
	—	1.5	0.15	15	8.4	8	5.6	4.8	6.8	13.6	—		
Carry Outputs Output Low (Sink) Current Min. I <sub>OL</sub>	—	0.4	0.5	5	0.64	0.61	0.42	0.36	0.51	1	—		
	—	0.5	0.10	10	1.6	1.5	1.1	0.9	1.3	2.6	—		
	—	1.5	0.15	15	4.2	4	2.8	2.4	3.4	6.8	—		
Output High (Source) Current Min. I <sub>OH</sub>	—	4.6	0.5	5	-0.64	-0.61	-0.42	-0.36	-0.51	-1	—		
	—	2.5	0.5	5	-2	-1.8	-1.3	-1.15	-1.6	-3.2	—		
	—	9.5	0.10	10	-1.6	-1.5	-1.1	-0.9	-1.3	-2.6	—		
	—	13.5	0.15	15	-4.2	-4	-2.8	-2.4	-3.4	-6.8	—		
Input Current Max. I <sub>IN</sub>	—	0.18	0.18	18	±0.1	±0.1	±1	±1	—	±10 <sup>-5</sup>	±0.1	μA	

■ 0(10 μA)

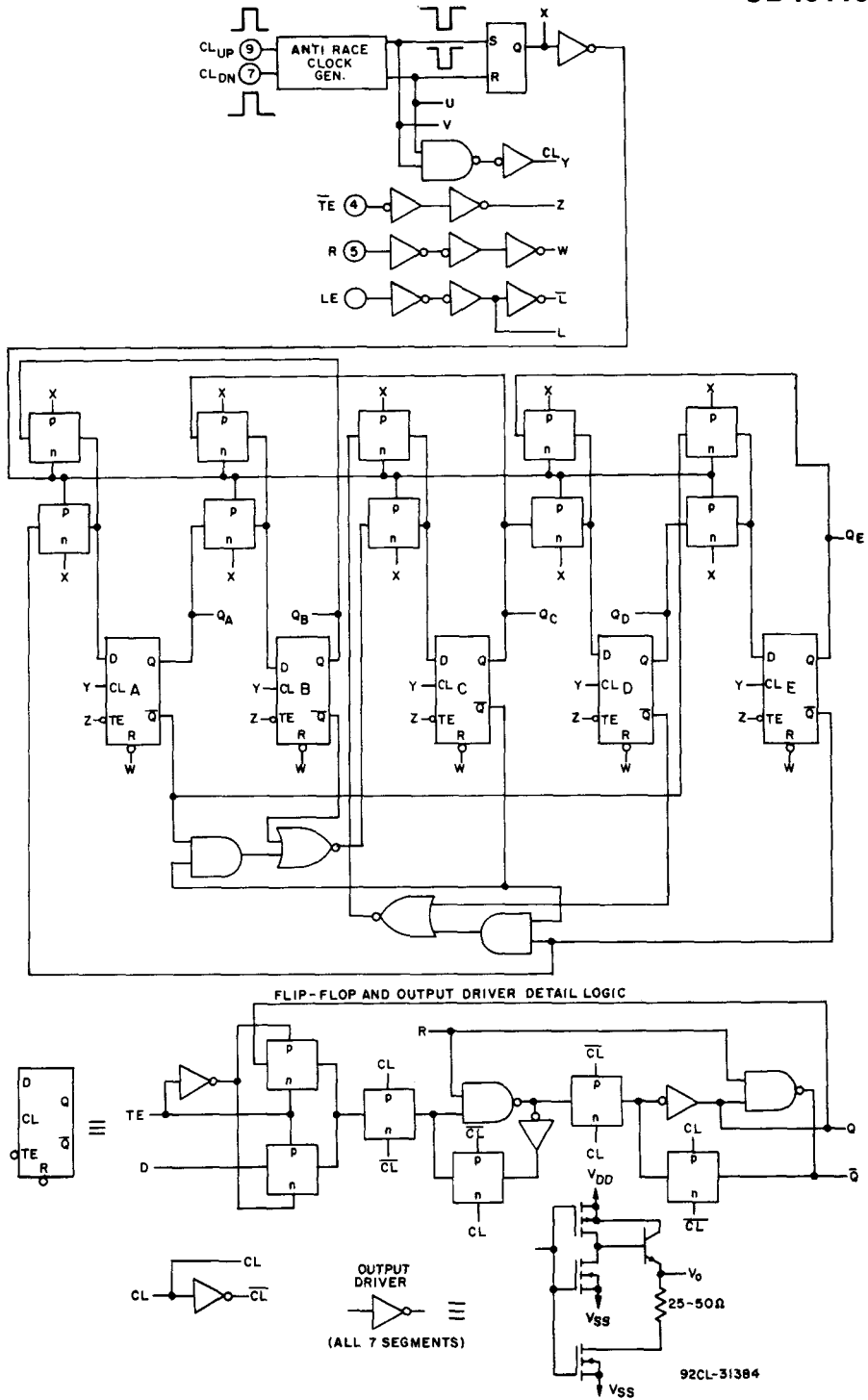
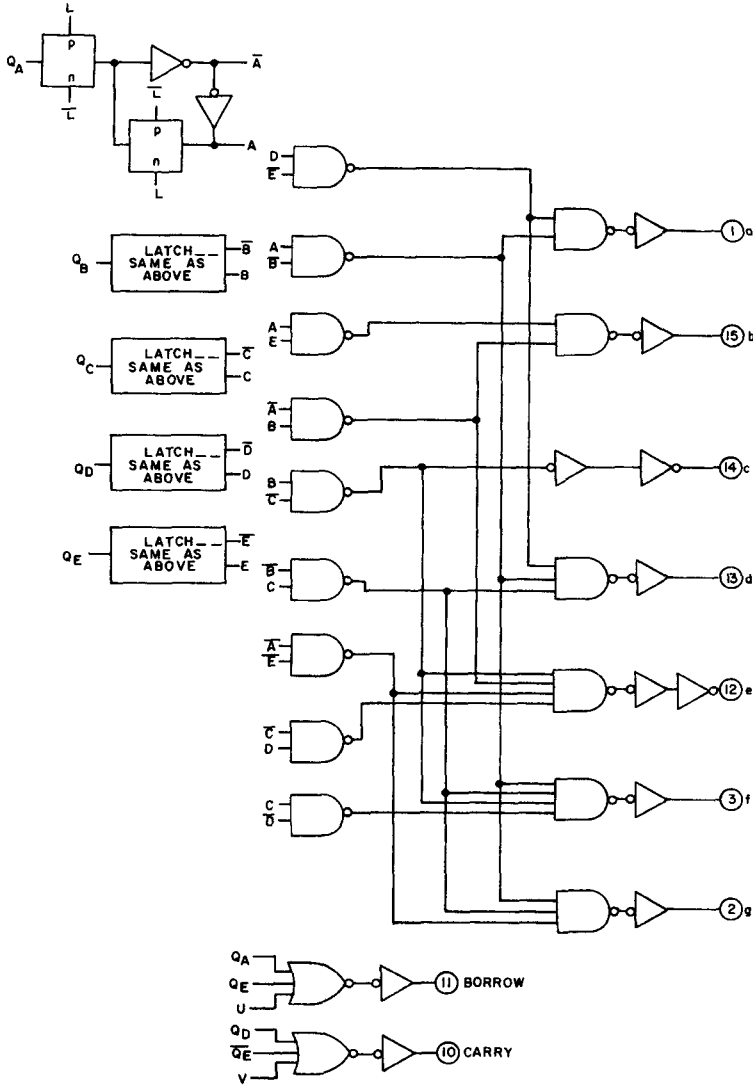

Fig. 2 - Logic diagram with flip-flop and output-driver details.  
(cont'd on page 5)

# CD40110B Types



92CL-31384

Fig. 2 - Logic diagram with flip-flop and output-driver details.

## DISPLAY SEGMENTS

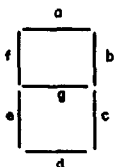

92CS-31376

## TERMINAL ASSIGNMENT

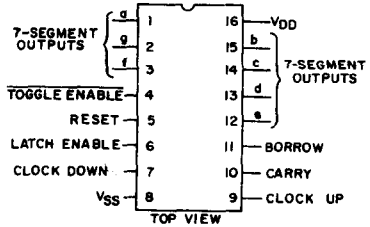

92CS-31377

## CD40110B Types

**DYNAMIC ELECTRICAL CHARACTERISTICS** at  $T_A = 25^\circ\text{C}$ , Input  $t_r, t_f = 20\text{ ns}$ ,  $C_L = 50\text{ pF}$ ,  $R_L = 200\text{ k}\Omega$

CHARACTERISTIC	VDD (V)	LIMITS			UNITS
		MIN.	TYP.	MAX.	
<b>Clock Up/Clock Down</b>					
Propagation Delay Time: Clock to Carry or Borrow $t_{PLH}, t_{PHL}$	5	—	300	600	ns
	10	—	100	200	
	15	—	70	140	
Clock to Segment $t_{PLH}, t_{PHL}$	5	—	925	1850	ns
	10	—	360	720	
	15	—	250	500	
Minimum Clock Pulse Width	5	—	55	110	ns
	10	—	20	40	
	15	—	15	30	
Maximum Clock Input Frequency (Sum of $CL_{UP}$ & $CL_{DN}$ ) $f_{CL}$	5	1	2.5	—	MHz
	10	3	6	—	
	15	5	8.5	—	
Minimum Toggle Enable Pulse Width	5	—	175	350	ns
	10	—	75	150	
	15	—	55	110	
Minimum Latch Enable Pulse Width	5	—	55	110	ns
	10	—	15	30	
	15	—	12	24	
Output Pulse Width: Carry	5	115	230	—	ns
	10	60	120	—	
	15	40	75	—	
Borrow	5	140	275	—	ns
	10	65	130	—	
	15	45	85	—	
Transition Time: Carry or Borrow $t_{TLH}, t_{THL}$	5	—	85	170	ns
	10	—	45	90	
	15	—	30	60	
Minimum Delay Time Between $CL_{UP}$ & $CL_{DN}$	5	—	100	—	ns
	10	—	80	—	
	15	—	60	—	
Maximum Clock Rise or Fall Time $t_{rCL}, t_{fCL}$	5	—	—	15	$\mu\text{s}$
	10	—	—	15	
	15	—	—	15	

### Reset

Propagation Delay Time Reset to Output $t_{PLH}, t_{PHL}$	5	—	650	1300	ns
	10	—	350	700	
	15	—	160	320	
Minimum Reset Removal Time	5	—	-275	0	ns
	10	—	-100	0	
	15	—	-65	0	
Minimum Reset Pulse Width	5	—	175	350	ns
	10	—	85	170	
	15	—	60	120	

# CD40110B Types

## TRUTH TABLE

CLOCK UP *	CLOCK DOWN *	LATCH ENABLE	TOGGLE ENABLE	RESET	COUNTER	DISPLAY
	X	0	0	0	Increments by 1	Follows Counter
X		0	0	0	Decrements by 1	Follows Counter
		X	X	0	No Change	No Change
X	X	1	X	1	Goes to 00000	Remains Fixed
X	X	0	X	1	Goes to 00000	Follows Counter (Display = )
X	X	X	1	0	Inhibited	Remains Fixed
	X	1	0	0	Increments by 1	Remains Fixed
X		1	0	0	Decrements by 1	Remains Fixed

X = Don't Care      1 = High State      0 = Low State

\* Typically 100 ns between clock-up and clock-down positive transitions are required to ensure proper counting.

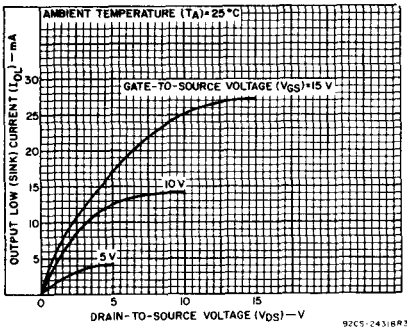

Fig. 3 - Typical carry or borrow output low (sink) current characteristics.

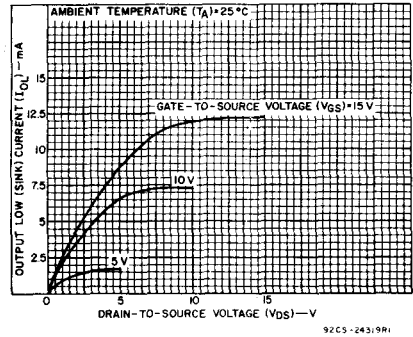

Fig. 4 - Minimum carry or borrow output low (sink) current characteristics.

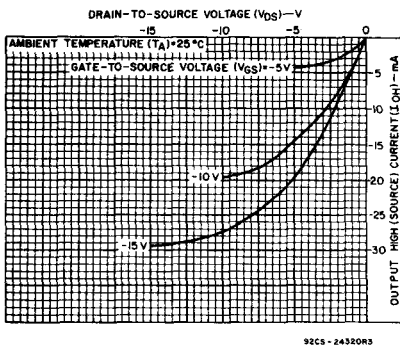

Fig. 5 - Typical carry or borrow output high (source) current characteristics.

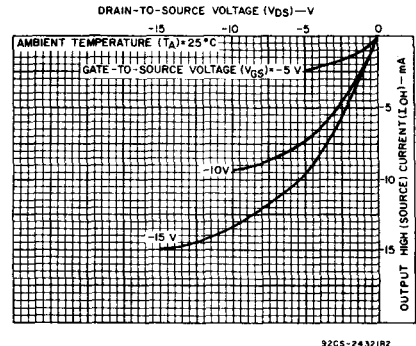

Fig. 6 - Minimum carry or borrow output high (source) current characteristics.

# CD40110B Types

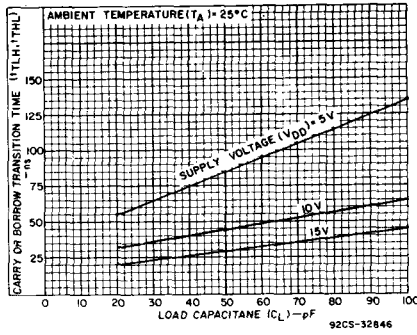

Fig. 7 - Typical carry or borrow transition time vs. load capacitance.

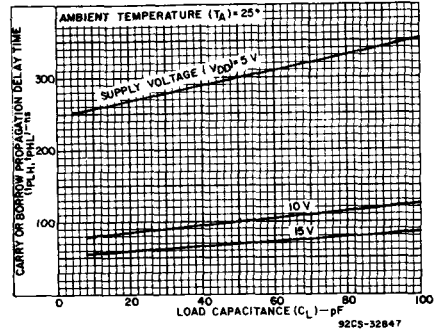

Fig. 8 - Typical carry or borrow propagation delay time vs. load capacitance.

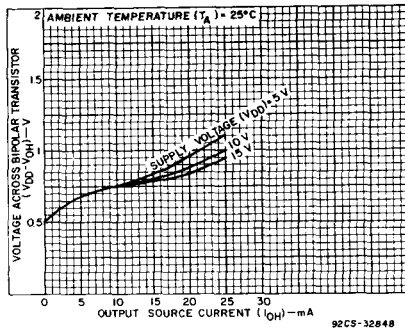

Fig. 9 - Voltage across bipolar transistor vs. output source current.

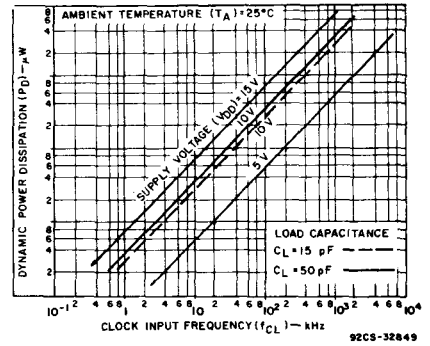

Fig. 10 - Typical dynamic power dissipation vs. frequency.

## TEST CIRCUITS

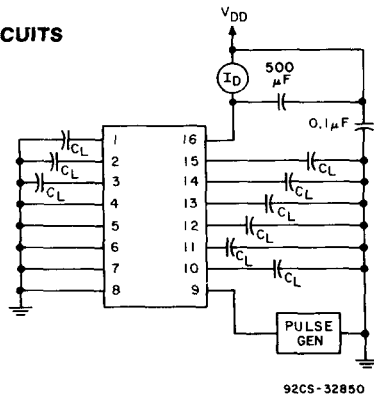

Fig. 11 - Dynamic power dissipation test circuit.

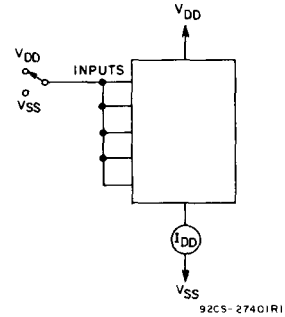

Fig. 12 - Quiescent device current.

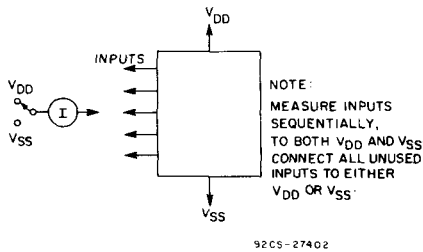

Fig. 13 - Input current.

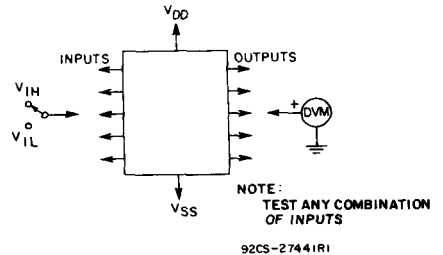

Fig. 14 - Input voltage.

# CD40110B Types

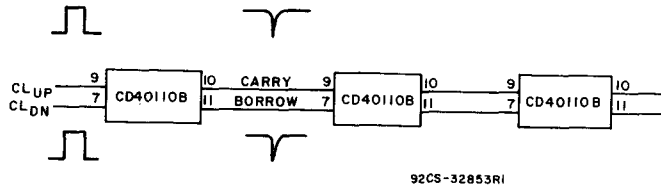
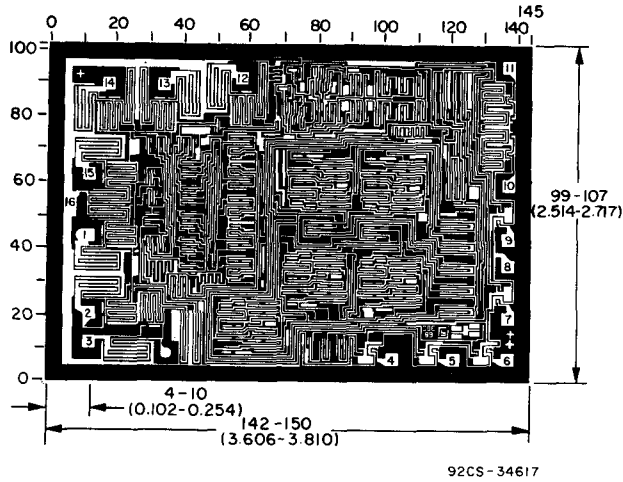

Fig. 15 - Cascading diagram.



Dimensions and pad layout for CD40110B.

Dimensions in parentheses are in millimeters and are derived from the basic inch dimensions as indicated. Grid graduations are in mils ( $10^{-3}$  inch).

The photographs and dimensions of each CMOS chip represent a chip when it is part of the wafer. When the wafer is separated into individual chips, the angle of cleavage may vary with respect to the chip face for different chips. The actual dimensions of the isolated chip, therefore, may differ slightly from the nominal dimensions shown. The user should consider a tolerance  $-3$  mils to  $+16$  mils applicable to the nominal dimensions shown.



# Programmable Dual 4-Bit Terminator

High-Voltage Types (20-Volt Rating)

**Features:**

- One standard "B" output will drive eight terminator circuits.
- Will terminate a CMOS data bus with up to 40 B-series inputs inputs or 3-state outputs connected at VDD of 5 V.
- Input terminals protected by standard "B" series ESD protection network.
- Preserves final logic state.
- Output after switching is closer to VDD or VSS rail than with a resistor.
- Requires only one solder connection.
- Open circuited terminator not used will not affect performance.
- Can be connected to any CMOS I/O line.
- Draws current only when logic state is changing.
- Can be preset.

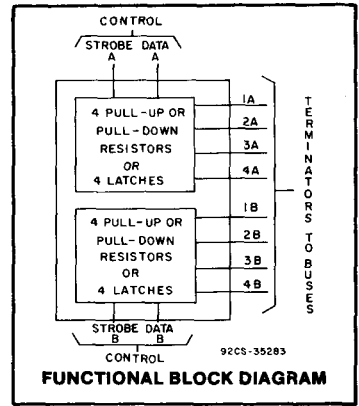

The RCA CD40117B is a dual 4-bit terminator that can be programmed by means of STROBE and DATA control bits to function as pull-up or pull-down resistors. The CD40117B can also be programmed to function as latches to terminate any open or unused CMOS logic when used with 3-state logic or during a power-down condition. Considerable savings in power and board space can be realized when this device is used to replace pull-up or pull-down resistors. When the STROBE is in the logic "1" state, the terminator functions as a pull-up resistor if the DATA input is a logic "1" or as a pull-down resistor if the DATA input is a logic "0".

When the STROBE is in the logic "0" state, the terminator performs the latch function, i.e., it follows the changing states of the bus. If the bus goes into the high-Z state or into a power-down condition, the latched terminator retains the data ("1" or "0") that the bus carried before it switched to the high-Z or power-down state. If and when the bus changes from the high-Z state to the state opposite to that which the latch is storing, the bus will override the latch and the terminator will reflect the state on the bus. The small geometries chosen for the inverters in the latch allow this override mode. When checking the data bus whose last state is being preserved by the terminator, a resistor should be used in series with the probe whose input capacitance could trip the small latches. The resistance should be in excess of the output impedance of the latch, i.e., R should be > 30 KΩ at VDD = 10 V.

The STROBE and DATA inputs in each section can be paralleled allowing this device to be used as an 8-bit bus terminator.

The CD40117B types are supplied in 14-lead hermetic dual-in-line ceramic packages (D and F suffixes), 14-lead dual-in-line plastic packages (E suffix), and in chip form (H suffix).

**Applications:**

- Error state identification.
- Replaces pull-up or pull-down resistors
- Avoids floating inputs in modular systems
- Sharpens transistors (hysteresis)
- Anti-bounce circuit

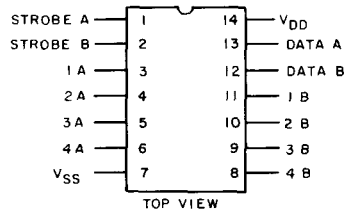

TERMINAL DIAGRAM

**TRUTH TABLE**

STROBE	DATA	1A(B)	2A(B)	3A(B)	4A(B)
1	0	0Δ	0Δ	0Δ	0Δ
1	1	1+	1+	1+	1+
0	X	*	*	*	*

1 = High, 0 = Low, X = Don't Care

Δ Equivalent to pull-down resistor.

+ Equivalent to pull-up resistor.

\* Equivalent to a latch.



TYPICAL APPLICATIONS

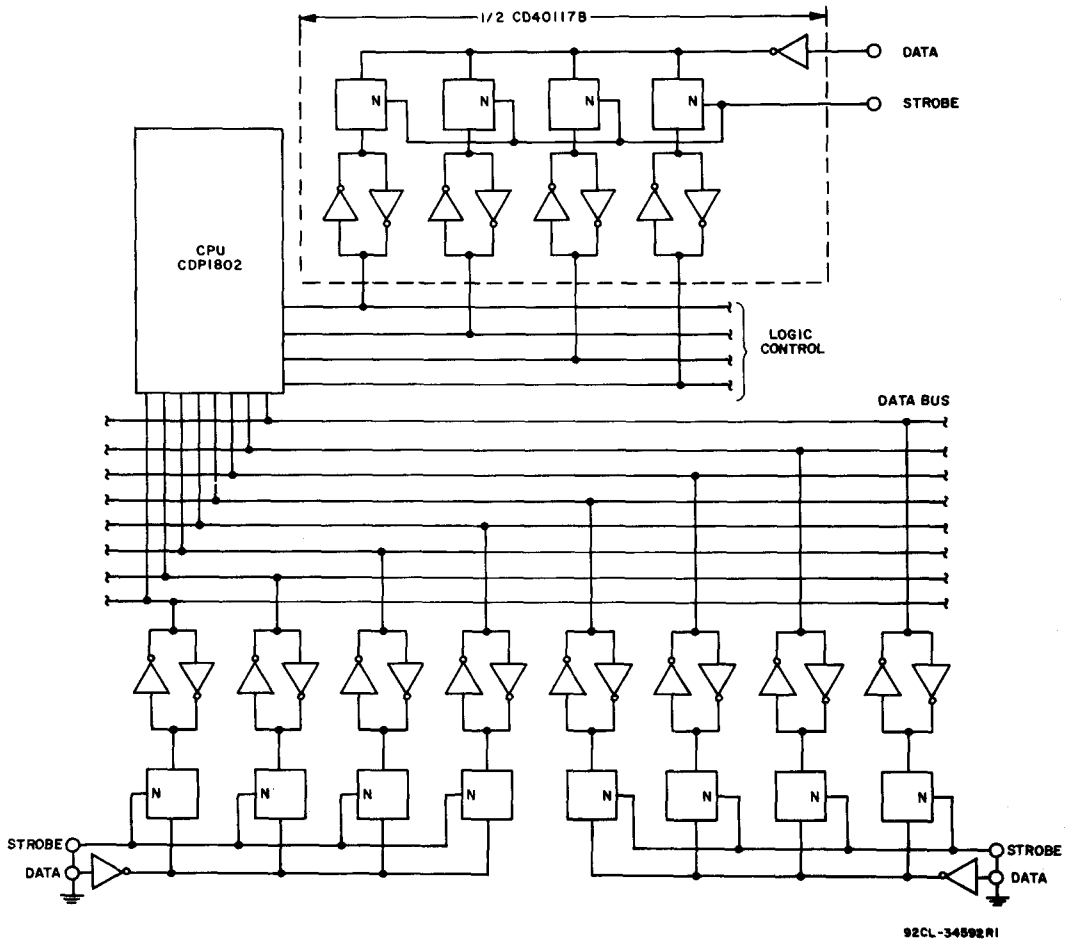

Fig. 2 - Schematic of CD40117B interfacing with microprocessor terminating an 8-bit bus line and 1/2 of CD40117B as a programmable pull-up/pull down logic controller.

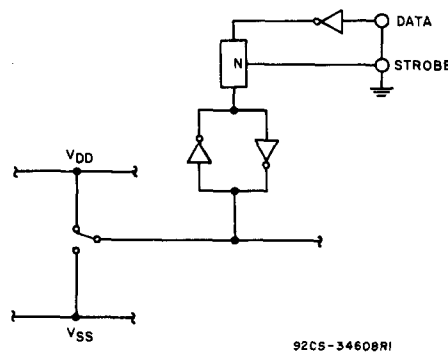

Fig. 3 - Schematic of CD40117B in anti-bounce circuit application.

# CD40117B Types

## STATIC ELECTRICAL CHARACTERISTICS

CHARACTERISTIC	CONDITIONS			LIMITS AT INDICATED TEMPERATURES (°C)							UNITS
	V <sub>O</sub> (V)	V <sub>IN</sub> (V)	V <sub>DD</sub> (V)	-55	-40	+85	+125	+25			
								Min.	Typ.	Max.	
Quiescent Device Current Max. I <sub>DD</sub>	—	0, 5	5	0.25	0.25	7.5	7.5	—	0.01	0.25	μA
	—	0, 10	10	0.5	0.5	15	15	—	0.01	0.5	
	—	0, 15	15	1	1	30	30	—	0.01	1	
	—	0, 20	20	5	5	150	150	—	0.02	5	
Output Low Sink Current Min. I <sub>OL</sub>	0.4	0, 5	5	—	—	—	—	—	25	—	μA
	0.5	0, 10	10	—	—	—	—	—	60	—	
	1.5	0, 15	15	—	—	—	—	—	250	—	
Output High (Source) Current Min. I <sub>OH</sub>	4.6	0, 5	5	—	—	—	—	—	-25	—	μA
	2.5	0, 5	5	—	—	—	—	—	—	—	
	9.5	0, 10	10	—	—	—	—	—	-60	—	
	13.5	0, 15	15	—	—	—	—	—	-250	—	
Output Voltage: Low-Level Max. V <sub>OL</sub>	—	0, 5	5	0.05				—	0	0.05	V
	—	0, 10	10	0.05				—	0	0.05	
	—	0, 15	15	0.05				—	0	0.05	
Output Voltage: High-Level Min. V <sub>OH</sub>	—	0, 5	5	4.95				4.95	5	—	V
	—	0, 10	10	9.95				9.95	10	—	
	—	0, 15	15	14.95				14.95	15	—	
Input Low Voltage Max. V <sub>IL</sub>	0.5, 4.5	—	5	1.5				—	—	1.5	V
	1, 9	—	10	3				—	—	3	
	1.5, 13.5	—	15	4				—	—	4	
Input High Voltage Min. V <sub>IH</sub>	0.5, 4.5	—	5	3.5				3.5	—	—	V
	1, 9	—	10	7				7	—	—	
	1.5, 13.5	—	15	11				11	—	—	
Input Current Max. I <sub>IN</sub>	—	0, 18	18	±0.1	±0.1	±1	±1	—	±10 <sup>-5</sup>	±0.1	μA

## DYNAMIC ELECTRICAL CHARACTERISTICS at T<sub>A</sub>=25°C; Input t<sub>r</sub>, t<sub>f</sub>=20 ns, C<sub>L</sub>=50 pF, R<sub>L</sub>=200 kΩ

CHARACTERISTIC		TEST CONDITIONS V <sub>DD</sub> (V)	LIMITS All Packages			UNITS
			MIN.	TYP.	MAX.	
Propagation Delay Time Strobe, Data to Outputs	t <sub>PHL</sub>	5	—	1.7	—	μs
		10	—	850	—	ns
		15	—	575	—	ns
Transition Time	t <sub>PLH</sub>	5	—	1.5	—	μs
		10	—	625	—	ns
		15	—	500	—	ns
Minimum Strobe Pulse Width	t <sub>W</sub>	5	—	1.5	—	μs
		10	—	600	—	ns
		15	—	475	—	ns
Minimum Data Pulse Width	t <sub>WH</sub> , t <sub>WL</sub>	5	—	1.6	—	μs
		10	—	700	—	ns
		15	—	500	—	ns
Minimum Terminator Input/Output Pulse Width	t <sub>W</sub>	5	—	10	—	ns
Minimum Data Setup Time Data to Strobe	t <sub>SU</sub>	5	—	0	—	ns
		10	—	0	—	ns
		15	—	0	—	ns
Input Capacitance	C <sub>IN</sub>	Any Input	—	5	—	pF

## 10-Line to 4-Line BCD Priority Encoder

High-Voltage Types (20-Volt Rating)

The RCA-CD40147B CMOS encoder features priority encoding of the inputs to ensure that only the highest-order data line is encoded. Ten data input lines (0-9) are encoded to four-line (8,4,2,1) BCD. The highest priority line is line 9. All four output lines are logic 1 ( $V_{SS}$ ) when all input lines are logic 0. All inputs and outputs are buffered, and each output can drive one TTL low-power Schottky load. The CD40147B is functionally similar to the TTL 54/74147 if pin 15 is tied low.

The CD40147B types are supplied in 16-lead ceramic dual-in-line packages (D and F suffixes), 16-lead dual-in-line plastic packages (E suffix), 16-lead ceramic flat packages (K suffix), and in chip form (H suffix).

### Features:

- Encodes 10-line to 4-line BCD
- Active low inputs and outputs
- Standardized, symmetrical output characteristics
- 100% tested for quiescent current at 20 V
- 5-V, 10-V, and 15-V parametric ratings
- Meets all requirements of JEDEC Tentative Standard No. 13A, "Standard Specifications for Description of 'B' Series CMOS Devices"
- Maximum input current of  $1 \mu\text{A}$  at 18 V over full package-temperature range; 100 nA at 18 V and  $25^\circ\text{C}$
- Noise margin (full package-temperature range) =
  - 1 V at  $V_{DD} = 5 \text{ V}$
  - 2 V at  $V_{DD} = 10 \text{ V}$
  - 2.5 V at  $V_{DD} = 15 \text{ V}$

### Applications:

- Keyboard encoding
- 10-line to BCD encoding
- Range selection

### RECOMMENDED OPERATING CONDITIONS

For maximum reliability, nominal operating conditions should be selected so that operation is always within the following range:

CHARACTERISTIC	LIMITS		UNITS
	Min.	Max.	
Supply Voltage Range (For $T_A = \text{Full Package Temperature Range}$ )	3	18	V

### TRUTH TABLE (Negative Logic)

INPUTS										OUTPUTS			
0	1	2	3	4	5	6	7	8	9	D	C	B	A
0	0	0	0	0	0	0	0	0	0	1	1	1	1
1	0	0	0	0	0	0	0	0	0	0	0	0	0
X	1	0	0	0	0	0	0	0	0	0	0	0	1
X	X	1	0	0	0	0	0	0	0	0	0	1	0
X	X	X	1	0	0	0	0	0	0	0	0	1	1
X	X	X	X	1	0	0	0	0	0	0	1	0	0
X	X	X	X	X	1	0	0	0	0	0	1	1	0
X	X	X	X	X	X	1	0	0	0	0	1	1	1
X	X	X	X	X	X	X	1	0	0	1	0	0	0
X	X	X	X	X	X	X	X	1	0	1	0	0	1

0 = High Level      1 = Low Level      X = Don't Care

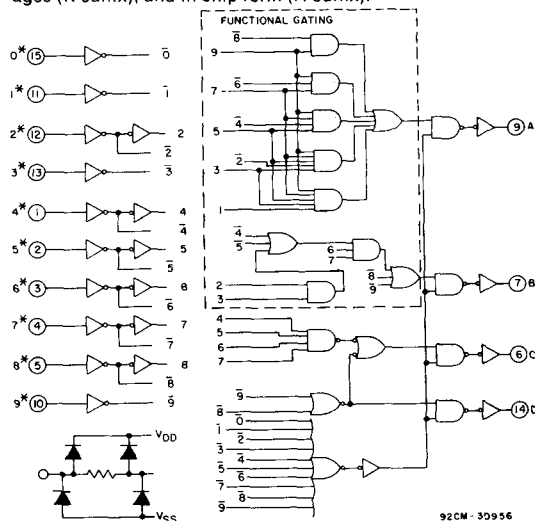
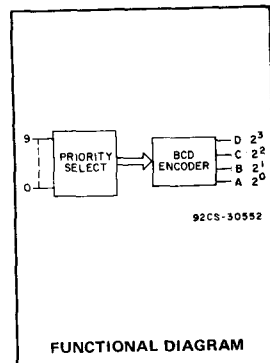

\* INPUTS PROTECTED BY CGS/MOS PROTECTION NETWORK

Fig. 1 - CD40147B logic diagram.

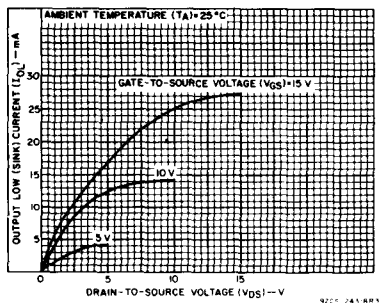

Fig. 2 - Typical output low (sink) current characteristics.

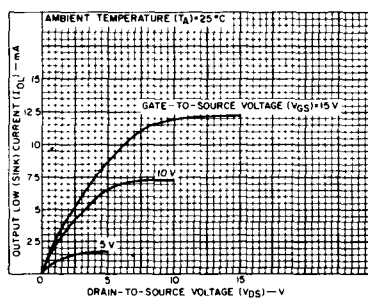

Fig. 3 - Minimum output low (sink) current characteristics.

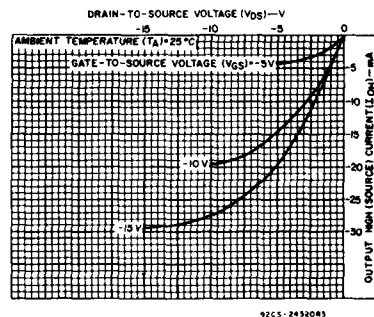

Fig. 4 - Typical output high (source) current characteristics.

# CD40147B Types

## MAXIMUM RATINGS, Absolute-Maximum Values:

DC SUPPLY-VOLTAGE RANGE, ( $V_{DD}$ ) (Voltages referenced to $V_{SS}$ Terminal)	-0.5 to +20 V
INPUT VOLTAGE RANGE, ALL INPUTS	-0.5 to $V_{DD}$ +0.5 V
DC INPUT CURRENT, ANY ONE INPUT	$\pm 10$ mA
POWER DISSIPATION PER PACKAGE ( $P_D$ ):	
For $T_A = -40$ to $+60^\circ\text{C}$ (PACKAGE TYPE E)	500 mW
For $T_A = +60$ to $+85^\circ\text{C}$ (PACKAGE TYPE E)	Derate Linearly at 12 mW/ $^\circ\text{C}$ to 200 mW
For $T_A = -55$ to $+100^\circ\text{C}$ (PACKAGE TYPES D, F, K)	500 mW
For $T_A = +100$ to $+125^\circ\text{C}$ (PACKAGE TYPES D, F, K)	Derate Linearly at 12 mW/ $^\circ\text{C}$ to 200 mW
DEVICE DISSIPATION PER OUTPUT TRANSISTOR:	
For $T_A = \text{FULL PACKAGE-TEMPERATURE RANGE (All Package Types)}$	100 mW
OPERATING-TEMPERATURE RANGE ( $T_A$ ):	
PACKAGE TYPES D, F, K, H	-55 to $+125^\circ\text{C}$
PACKAGE TYPE E	-40 to $+85^\circ\text{C}$
STORAGE TEMPERATURE RANGE ( $T_{stg}$ )	-65 to $+150^\circ\text{C}$
LEAD TEMPERATURE (DURING SOLDERING):	
At distance 1/16 $\pm$ 1/32 inch (1.59 $\pm$ 0.79 mm) from case for 10 s max.	$+265^\circ\text{C}$

## STATIC ELECTRICAL CHARACTERISTICS

CHARACTERISTIC	CONDITIONS			LIMITS AT INDICATED TEMPERATURES ( $^\circ\text{C}$ )							UNITS
	$V_O$ (V)	$V_{IN}$ (V)	$V_{DD}$ (V)	Values at -55, +25, +125 Apply to D, F, K, H, Packages				+25			
				-55	-40	+85	+125	Min.	Typ.	Max.	
Quiescent Device Current, $I_{DD}$ Max.	-	0.5	5	1	1	30	30	-	0.02	1	$\mu\text{A}$
	-	0.10	10	2	2	60	60	-	0.02	2	
	-	0.15	15	4	4	120	120	-	0.02	4	
	-	0.20	20	20	20	600	600	-	0.04	20	
Output Low (Sink) Current $I_{OL}$ Min.	0.4	0.5	5	0.64	0.61	0.42	0.36	0.51	1	-	mA
	0.5	0.10	10	1.6	1.5	1.1	0.9	1.3	2.6	-	
	1.5	0.15	15	4.2	4	2.8	2.4	3.4	6.8	-	
Output High (Source) Current, $I_{OH}$ Min.	4.6	0.5	5	-0.64	-0.61	-0.42	-0.36	-0.51	-1	-	mA
	2.5	0.5	5	-2	-1.8	-1.3	-1.15	-1.6	-3.2	-	
	9.5	0.10	10	-1.6	-1.5	-1.1	-0.9	-1.3	-2.6	-	
	13.5	0.15	15	-4.2	-4	-2.8	-2.4	-3.4	-6.8	-	
Output Voltage: Low-Level, $V_{OL}$ Max.	-	0.5	5			0.05		-	0	0.05	V
	-	0.10	10			0.05		-	0	0.05	
	-	0.15	15			0.05		-	0	0.05	
Output Voltage: High-Level, $V_{OH}$ Min.	-	0.5	5			4.95		4.95	5	-	V
	-	0.10	10			9.95		9.95	10	-	
	-	0.15	15			14.95		14.95	15	-	
Input Low Voltage, $V_{IL}$ Max.	0.5, 4.5	-	5			1.5		-	-	1.5	V
	1.9	-	10			3		-	-	3	
	1.5, 13.5	-	15			4		-	-	4	
Input High Voltage, $V_{IH}$ Min.	0.5, 4.5	-	5			3.5		3.5	-	-	V
	1.9	-	10			7		7	-	-	
	1.5, 13.5	-	15			11		11	-	-	
Input Current $I_{IN}$ Max.	-	0.18	18	$\pm 0.1$	$\pm 0.1$	$\pm 1$	$\pm 1$	-	$\pm 10^{-5}$	$\pm 0.1$	$\mu\text{A}$

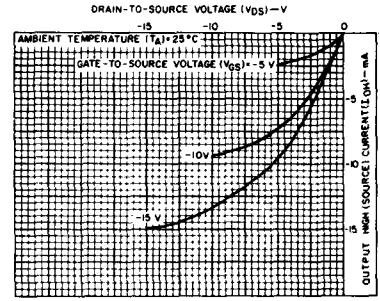

Fig. 5 - Minimum output high (source) current characteristics.

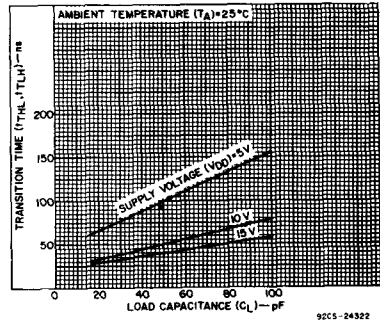

Fig. 6 - Typical transition time as a function of load capacitance.

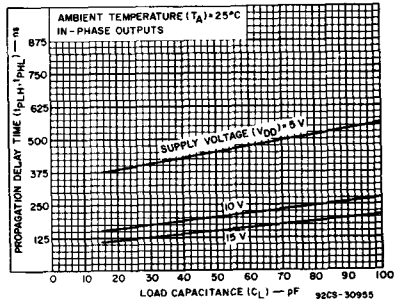

Fig. 7 - Propagation delay time as a function of load capacitance.

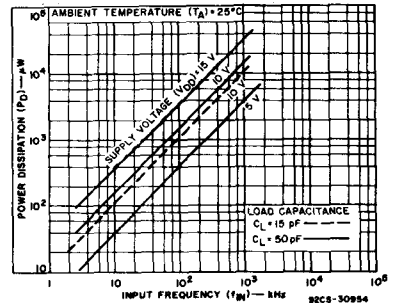

Fig. 8 - Typical dynamic power dissipation as a function of input frequency.

# CD40147B Types

DYNAMIC ELECTRICAL CHARACTERISTICS at  $T_A = 25^\circ\text{C}$ , Input  $t_r, t_f = 20 \text{ ns}$ ,  $C_L = 50 \text{ pF}$ ,  $R_L = 200 \text{ k}\Omega$

CHARACTERISTIC	TEST CONDITIONS	LIMITS ALL TYPES		UNITS
		$V_{DD}$ (V)	Typ. / Max.	
Propagation Delay Time, $t_{PLH}, t_{PHL}$ In-Phase Output	Any input to any output	5	450 / 900	ns
		10	200 / 400	
		15	150 / 300	
Out-of-Phase Output		5	425 / 850	ns
		10	175 / 350	
		15	125 / 250	
Transition Time, $t_{THL}, t_{TLH}$	5	100 / 200	ns	
	10	50 / 100		
	15	40 / 80		
Input Capacitance, $C_1$	Any Input	5	7.5	pF

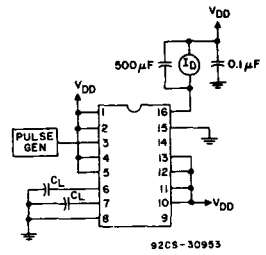

Fig. 9 – Dynamic power dissipation test circuit.

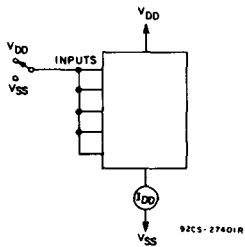

Fig. 10 – Quiescent device current test circuit.

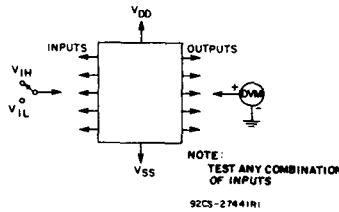

Fig. 11 – Input voltage test circuit.

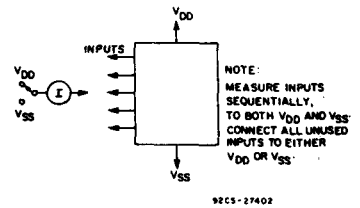
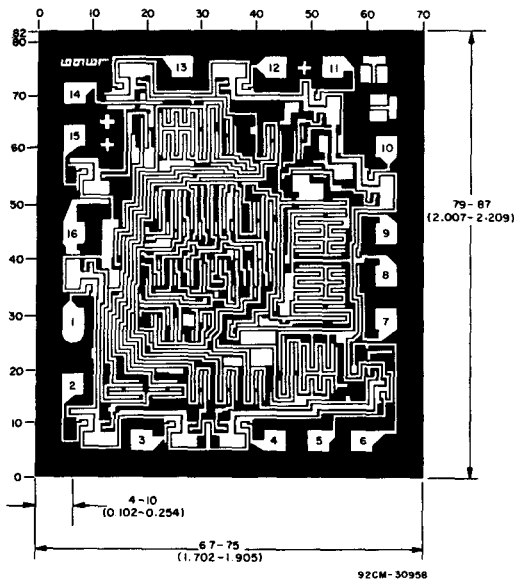
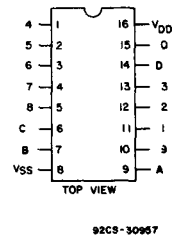

Fig. 12 – Input current test circuit.



Dimensions and pad layout for CD40147BH



CD40147B  
TERMINAL  
ASSIGNMENT

Dimensions in parentheses are in millimeters and are derived from the basic inch dimensions as indicated. Grid graduations are in mils ( $10^{-3}$  inch).

The photographs and dimensions of each CMOS chip represent a chip when it is part of the wafer. When the wafer is separated into individual chips, the angle of cleavage may vary with respect to the chip face for different chips. The actual dimensions of the isolated chip, therefore, may differ slightly from the nominal dimensions shown. The user should consider a tolerance of  $-3$  mils to  $+16$  mils applicable to the nominal dimensions shown.

# CD40160B, CD40161B, CD40162B, CD40163B Types

## CMOS Synchronous Programmable 4-Bit Counters

High-Voltage Types (20-Volt Rating)

**CD40160B** — Decade with Asynchronous Clear

**CD40161B** — Binary with Asynchronous Clear

**CD40162B** — Decade with Synchronous Clear

**CD40163B** — Binary with Synchronous Clear

RCA-CD40160B, CD40161B, CD40162B, and CD40163B are 4-bit synchronous programmable counters. The CLEAR function of the CD40162B and CD40163B is synchronous and a low level at the CLEAR input sets all four outputs low on the next positive CLOCK edge. The CLEAR function of the CD40160B and CD40161B is asynchronous and a low level at the CLEAR input sets all four outputs low regardless of the state of the CLOCK, LOAD, or ENABLE inputs. A low level at the LOAD input disables the counter and causes the output to agree with the setup data after the next CLOCK pulse regardless of the conditions of the ENABLE inputs.

The carry look-ahead circuitry provides for cascading counters for n-bit synchronous applications without additional gating. Instrumental in accomplishing this function are two count-enable inputs and a carry output (C<sub>OUT</sub>). Counting is enabled when both PE and TE inputs are high. The TE input is fed forward to enable C<sub>OUT</sub>. This enabled output produces a positive output pulse with a

### Features:

- Internal look-ahead for fast counting
- Carry output for cascading
- Synchronously programmable
- Clear asynchronous input (CD40160B, CD40161B)
- Clear synchronous input (CD40162B, CD40163B)
- Synchronous load control input
- Low-power TTL compatibility
- Standardized, symmetrical output characteristics
- 100% tested for quiescent current at 20 V
- Maximum input current of 1  $\mu$ A at 18 V over full package-temperature range; 100 nA at 18 V and 25°C
- Noise margin (over full package-temperature range): 1 V at V<sub>DD</sub> = 5 V, 2 V at V<sub>DD</sub> = 10 V, 2.5 V at V<sub>DD</sub> = 15 V
- 5-V, 10-V, and 15-V parametric ratings
- Meets all requirements of JEDEC Tentative Standard No. 13A, "Standard Specifications for Description of 'B' Series CMOS Devices"

duration approximately equal to the positive portion of the Q1 output. This positive overflow carry pulse can be used to enable successive cascaded stages. Logic transitions at the PE or TE inputs may occur when the clock is either high or low.

The CD40160B, CD40161B, CD40162B, and CD40163B types are supplied in 16-lead hermetic dual-in-line ceramic packages (D and F suffixes), 16-lead dual-in-line plastic packages (E suffix), 16-lead ceramic flat packages (K suffix), and in chip form (H suffix).

The CD40160B through CD40163B types are functionally equivalent to and pin-compatible with the TTL counter series 74LS160 through 74LS163 respectively.

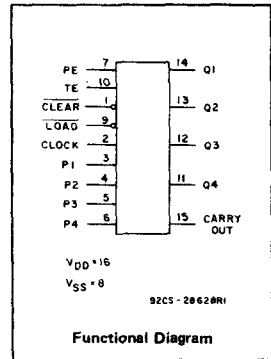

### Applications:

- Programmable binary and decade counting
- Counter control/timers
- Frequency dividing

### MAXIMUM RATINGS, Absolute-Maximum Values:

DC SUPPLY-VOLTAGE RANGE, (V <sub>DD</sub> ) (Voltages referenced to V <sub>SS</sub> Terminal)	-0.5 to +20 V
INPUT VOLTAGE RANGE, ALL INPUTS	-0.5 to V <sub>DD</sub> +0.5 V
DC INPUT CURRENT, ANY ONE INPUT	±10 mA
POWER DISSIPATION PER PACKAGE (P <sub>D</sub> ):	
For T <sub>A</sub> = -40 to +60°C (PACKAGE TYPE E)	500 mW
For T <sub>A</sub> = +60 to +85°C (PACKAGE TYPE E)	Derate Linearly at 12 mW/°C to 200 mW
For T <sub>A</sub> = -55 to +100°C (PACKAGE TYPES D, F, K)	500 mW
For T <sub>A</sub> = +100 to +125°C (PACKAGE TYPES D, F, K)	Derate Linearly at 12 mW/°C to 200 mW
DEVICE DISSIPATION PER OUTPUT TRANSISTOR:	
For T <sub>A</sub> = FULL PACKAGE-TEMPERATURE RANGE (All Package Types)	100 mW
OPERATING-TEMPERATURE RANGE (T <sub>A</sub> ):	
PACKAGE TYPES D, F, K, H	-55 to +125°C
PACKAGE TYPE E	-40 to +85°C
STORAGE TEMPERATURE RANGE (T <sub>stg</sub> )	-65 to +150°C
LEAD TEMPERATURE (DURING SOLDERING):	
At distance 1/16 ± 1/32 inch (1.59 ± 0.79 mm) from case for 10 s max.	+265°C

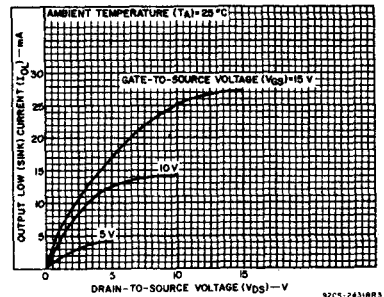

Fig. 1— Typical output low (sink) current characteristics.

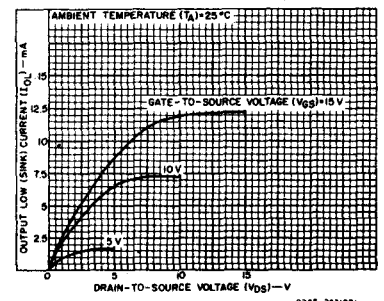

Fig. 2— Minimum output low (sink) current characteristics.



# CD40160B, CD40161B, CD40162B, CD40163B Types

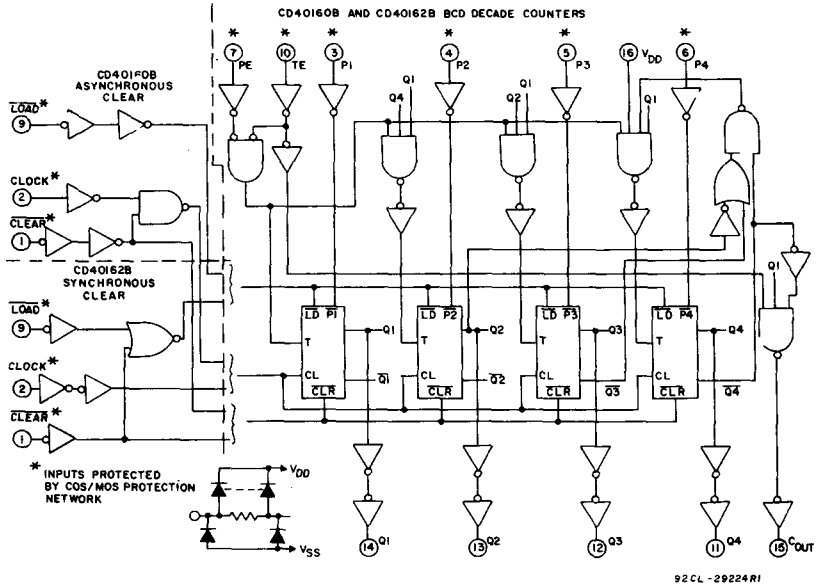

Fig. 3— Logic diagrams for CD40160B and CD40162B BCD decade counters.

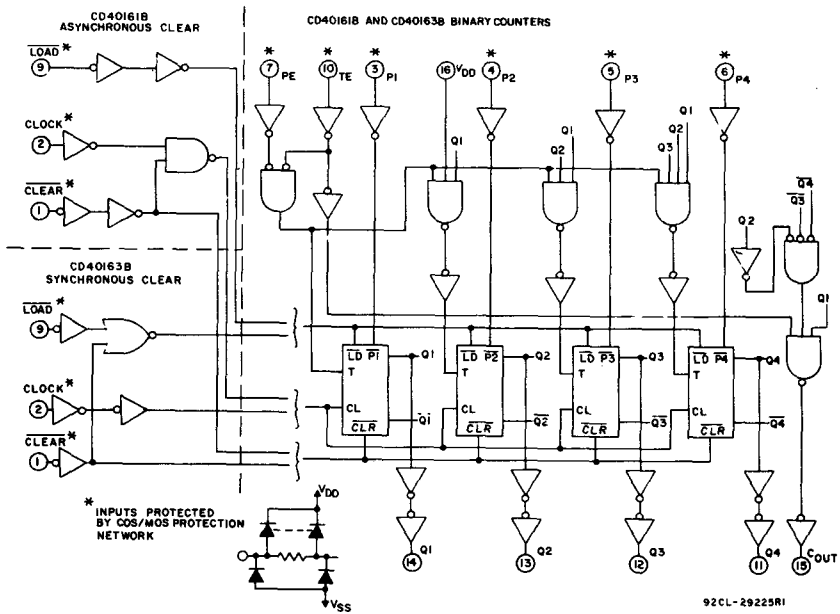

Fig. 4— Logic diagrams for CD40161B and CD40163B binary counters.

# CD40160B, CD40161B, CD40162B, CD40163B Types

**RECOMMENDED OPERATING CONDITIONS** at  $T_A = 25^\circ\text{C}$ , Except as Noted  
 For maximum reliability, nominal operating conditions should be selected so that operation is always within the following ranges:

CHARACTERISTIC	$V_{DD}$ (V)	LIMITS		UNITS
		MIN.	MAX.	
Supply Voltage Range (Full $T_A$ = Full Package-Temperature Range)	—	3	18	V
Setup Time: $t_{SU}$ Data to Clock	5	240	—	ns
	10	90	—	
	15	60	—	
Load to Clock	5	240	—	ns
	10	90	—	
	15	60	—	
PE or TE to Clock	5	340	—	ns
	10	140	—	
	15	100	—	
Clear to Clock (CD40162B, CD40163B)	5	340	—	ns
	10	140	—	
	15	100	—	
All Hold Times, $t_H$	5	0	—	ns
	10	0	—	
	15	0	—	
Clear Removal Time, $t_{rem}$ (CD40160B, CD40161B)	5	200	—	ns
	10	100	—	
	15	70	—	
Clear Pulse Width, $t_{WL}$ (CD40160B, CD40161B)	5	170	—	ns
	10	70	—	
	15	50	—	
Clock Input Frequency, $f_{CL}$	5	—	2	MHz
	10	—	5.5	
	15	—	8	
Clock Pulse Width, $t_W$	5	170	—	ns
	10	70	—	
	15	50	—	
Clock Rise or Fall Time, $t_{rCL}$ or $t_{fCL}$	5	—	200	$\mu\text{s}$
	10	—	70	
	15	—	15	

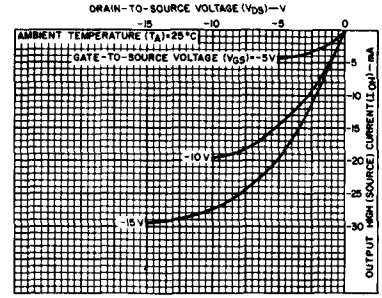

Fig. 5—Typical output high (source) current characteristics.

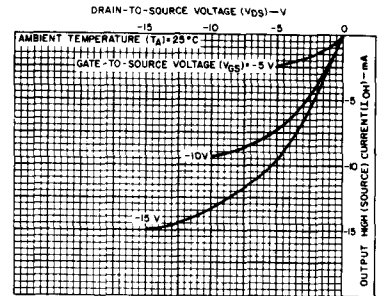

Fig. 6—Minimum output high (source) current characteristics.

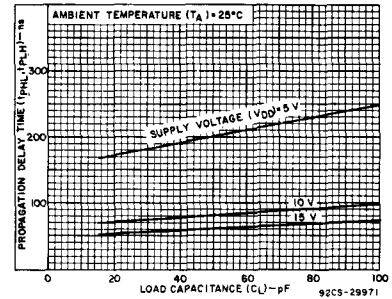

Fig. 7—Typical propagation delay time as a function of load capacitance (CLOCK to Q).

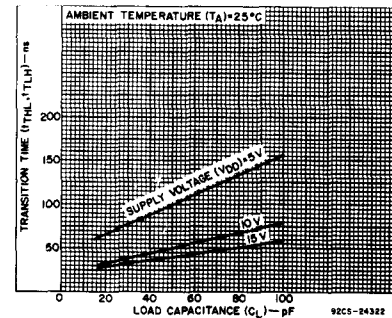

Fig. 8—Typical transition time as a function of load capacitance.

### TRUTH TABLE

CLOCK	$\overline{\text{CLR}}$	$\overline{\text{LOAD}}$	PE	TE	OPERATION
	1	0	X	X	PRESET
	1	1	0	X	NC
	1	1	X	0	NC
	1	1	1	1	COUNT
X	0	X	X	X	RESET (CD40160B, CD40161B)
	0	X	X	X	RESET (CD40162B, CD40163B)
	1	X	X	X	NC (CD40162B, CD40163B)

1 = HIGH LEVEL    0 = LOW LEVEL    X = DON'T CARE    NC = NO CHANGE

# CD40160B, CD40161B, CD40162B, CD40163B Types

## STATIC ELECTRICAL CHARACTERISTICS

CHARACTERISTIC	CONDITIONS			LIMITS AT INDICATED TEMPERATURES (°C)							UNITS
	V <sub>O</sub> (V)	V <sub>IN</sub> (V)	V <sub>DD</sub> (V)	Values at -55, +25, +125 Apply to D, F, K, H, Packages				Values at -40, +25, +85 Apply to E Packages			
				-55	-40	+85	+125	+25			
				Min.	Typ.	Max.					
Quiescent Device Current, I <sub>DD</sub> Max.	-	0.5	5	5	5	150	150	-	0.04	5	μA
	-	0.10	10	10	10	300	300	-	0.04	10	
	-	0.15	15	20	20	600	600	-	0.04	20	
	-	0.20	20	100	100	3000	3000	-	0.08	100	
Output Low (Sink) Current, I <sub>OL</sub> Min.	0.4	0.5	5	0.64	0.61	0.42	0.36	0.51	1	-	mA
	0.5	0.10	10	1.6	1.5	1.1	0.9	1.3	2.6	-	
	1.5	0.15	15	4.2	4	2.8	2.4	3.4	6.8	-	
Output High (Source) Current, I <sub>OH</sub> Min.	4.6	0.5	5	-0.64	-0.61	-0.42	-0.36	-0.51	-1	-	mA
	2.5	0.5	5	-2	-1.8	-1.3	-1.15	-1.6	-3.2	-	
	9.5	0.10	10	-1.6	-1.5	-1.1	-0.9	-1.3	-2.6	-	
	13.5	0.15	15	-4.2	-4	-2.8	-2.4	-3.4	-6.8	-	
Output Voltage: Low-Level, V <sub>OL</sub> Max.	-	0.5	5	0.05			-	0	0.05	-	V
	-	0.10	10	0.05			-	0	0.05	-	
	-	0.15	15	0.05			-	0	0.05	-	
Output Voltage: High-Level, V <sub>OH</sub> Min.	-	0.5	5	4.95			-	4.95	5	-	V
	-	0.10	10	9.95			-	9.95	10	-	
	-	0.15	15	14.95			-	14.95	15	-	
Input Low Voltage, V <sub>IL</sub> Max.	0.5, 4.5	-	5	1.5			-	-	1.5	-	V
	1.9	-	10	3			-	-	3	-	
	1.5, 13.5	-	15	4			-	-	4	-	
Input High Voltage, V <sub>IH</sub> Min.	0.5, 4.5	-	5	3.5			-	3.5	-	-	V
	1.9	-	10	7			-	7	-	-	
	1.5, 13.5	-	15	11			-	11	-	-	
Input Current, I <sub>IN</sub> Max.	-	0.18	18	±0.1	±0.1	±1	±1	-	±10 <sup>-5</sup>	±0.1	μA

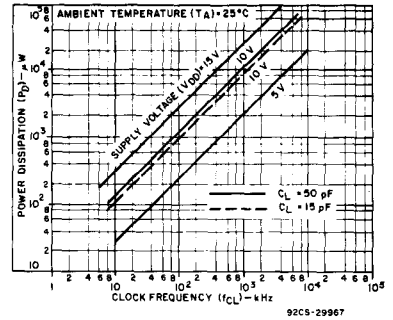

Fig. 9— Typical power dissipation as a function of CLOCK frequency.

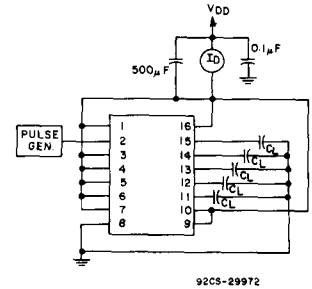

Fig. 10— Dynamic power dissipation test circuit.

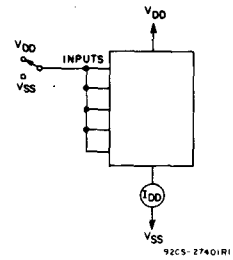

Fig. 11— Quiescent device current test circuit.

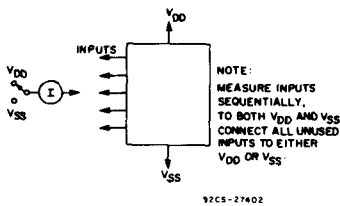

Fig. 12— Input current test circuit.

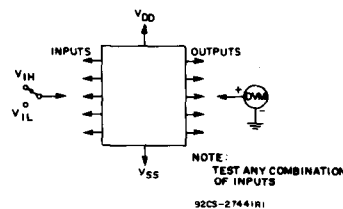

Fig. 13— Input voltage test circuit.

## TERMINAL ASSIGNMENT

CLEAR	1	16	V <sub>DD</sub>
CLOCK	2	15	CARRY OUT
P1	3	14	Q1
P2	4	13	Q2
P3	5	12	Q3
P4	6	11	Q4
PE	7	10	TE
V <sub>SS</sub>	8	9	LOAD

TOP VIEW

92CS-29959

# CD40160B, CD40161B, CD40162B, CD40163B Types

DYNAMIC ELECTRICAL CHARACTERISTICS at  $T_A = 25^\circ\text{C}$ ;

Input  $t_r, t_f = 20 \text{ ns}$ ,  $C_L = 50 \text{ pF}$ ,  $R_L = 200 \text{ k}\Omega$

CHARACTERISTIC	TEST CONDITIONS $V_{DD}$ (V)	LIMITS ALL TYPES*			UNITS
		Min.	Typ.	Max.	
<b>CLOCK OPERATION</b>					
Propagation Delay Time, $t_{PHL}, t_{PLH}$ Clock to Q	5	—	200	400	ns
	10	—	80	160	
	15	—	60	120	
Clock to $C_{OUT}$	5	—	225	450	ns
	10	—	95	190	
	15	—	70	140	
TE to $C_{OUT}$	5	—	125	250	ns
	10	—	55	110	
	15	—	40	80	
Minimum Setup Time, $t_{SU}$ Data to Clock	5	—	120	240	ns
	10	—	45	90	
	15	—	30	60	
Load to Clock	5	—	120	240	ns
	10	—	45	90	
	15	—	30	60	
PE to TE to Clock	5	—	170	340	ns
	10	—	70	140	
	15	—	50	100	
Minimum Hold Time, $t_H$	5	—	—	0	ns
	10	—	—	0	
	15	—	—	0	
Transition Time, $t_{THL}, t_{TLH}$	5	—	100	200	ns
	10	—	50	100	
	15	—	40	80	
Minimum Clock Pulse Width, $t_W$	5	—	85	170	ns
	10	—	35	70	
	15	—	25	50	
Maximum Clock Frequency, $f_{CL}$	5	2	3	—	MHz
	10	5.5	8.5	—	
	15	8	12	—	
Maximum Clock Rise or Fall Time, † $t_{rCL}, t_{fCL}$	5	200	—	—	$\mu\text{s}$
	10	70	—	—	
	15	15	—	—	
<b>CLEAR OPERATION</b>					
Propagation Delay Time, $t_{PHL}$ (CD40160B, CD40161B) Clear to Q	5	—	250	500	ns
	10	—	110	220	
	15	—	80	160	
Minimum Setup Time, $t_{SU}$ (CD40162B, CD40163B) Clear to Clock	5	—	170	340	ns
	10	—	70	140	
	15	—	50	100	
Minimum Hold Time, $t_H$ (CD40162B, CD40163B) Clear to Clock	5	—	—	0	ns
	10	—	—	0	
	15	—	—	0	
Minimum Clear Removal Time, $t_{rem}$ (CD40160B, CD40161B)	5	—	100	200	ns
	10	—	50	100	
	15	—	35	70	
Minimum Clear Pulse Width, $t_{WL}$ (CD40160B, CD40161B)	5	—	85	170	ns
	10	—	35	70	
	15	—	25	50	

\* Except as noted.

† If more than one unit is cascaded in the parallel clocked application,  $t_{rCL}$  should be made less than or equal to the sum of the fixed propagation delay at 50 pF and the transition time of the carry output driving stage for the estimated capacitive load.

# CD40160B, CD40161B, CD40162B, CD40163B Types

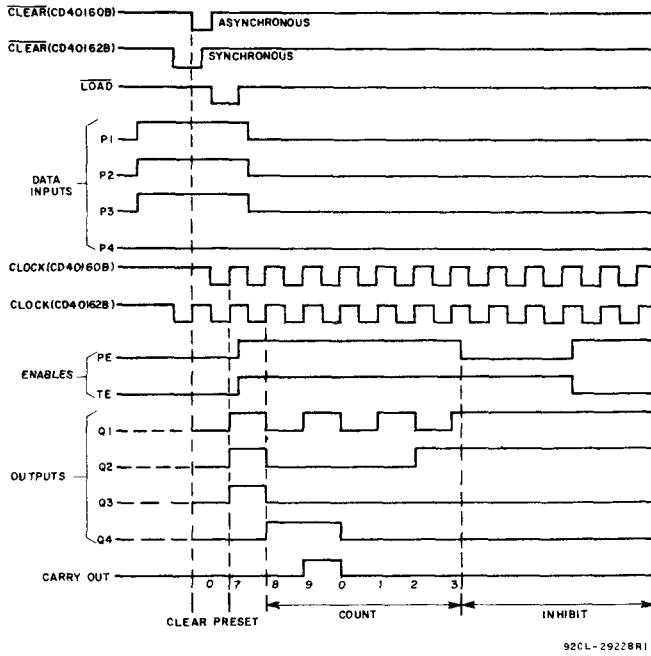

Fig. 14— Timing diagram for CD40160B, CD40162B.

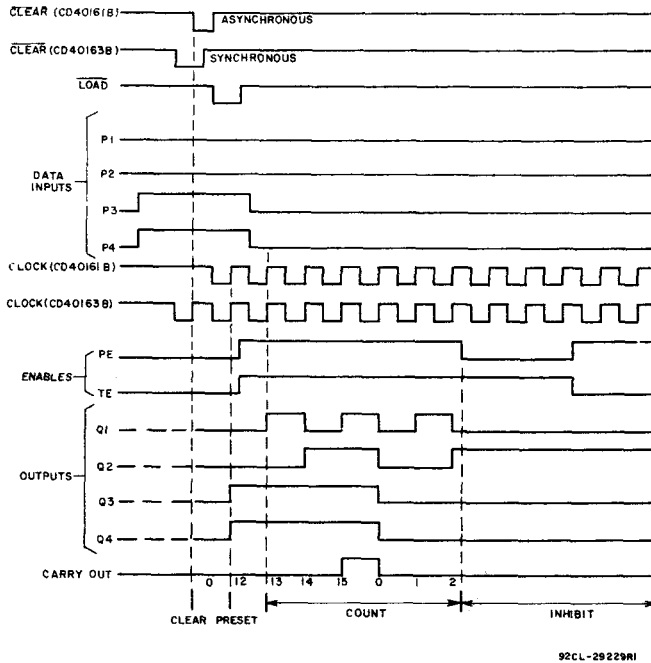

Fig. 15— Timing diagram for CD40161B, CD40163B.

# CD40160B, CD40161B, CD40162B, CD40163B Types

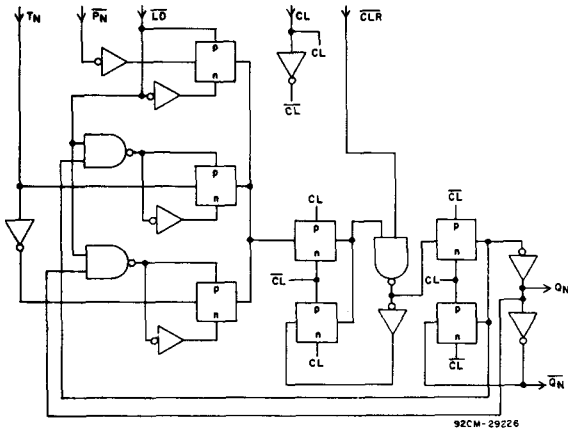

Fig. 16— Detail of flip-flops of CD40160B and CD40161B (asynchronous clear).

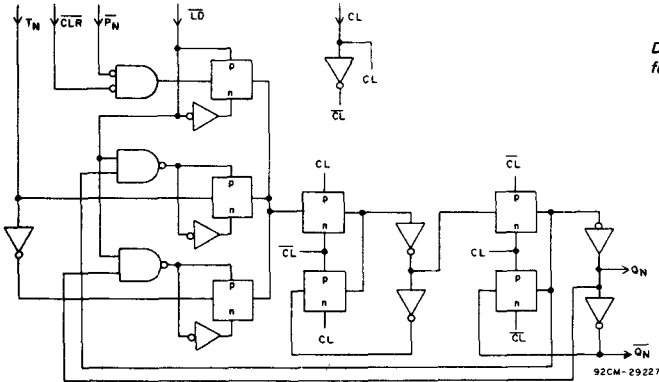
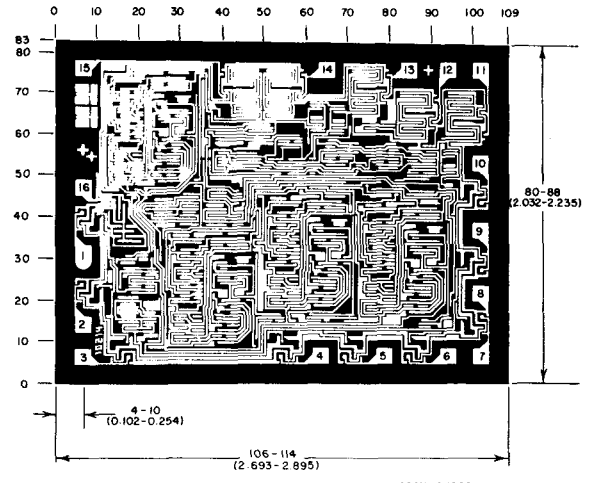

Fig. 17— Detail of flip-flops for CD40162B and CD40163B (synchronous clear).



Dimensions and pad layout for CD40160BH. Dimensions and pad layout for CD40161BH, CD40162BH, and CD40163BH are identical.

Dimensions in parentheses are in millimeters and are derived from the basic inch dimensions as indicated. Grid graduations are in mils ( $10^{-3}$  inch).

The photographs and dimensions of each CMOS chip represent a chip when it is part of the wafer. When the wafer is separated into individual chips, the angle of cleavage may vary with respect to the chip face for different chips. The actual dimensions of the isolated chip, therefore, may differ slightly from the nominal dimensions shown. The user should consider a tolerance of  $-3$  mils to  $+16$  mils applicable to the nominal dimensions shown.

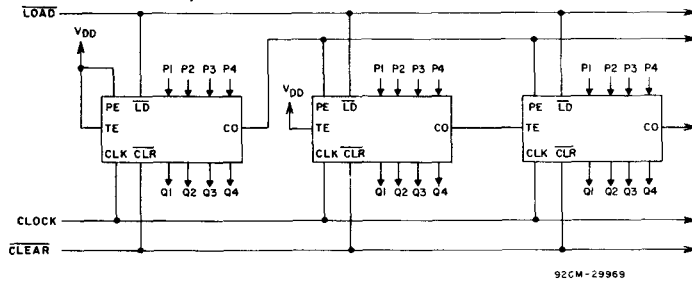

Fig. 18 — Cascaded counter packages in the parallel-clocked mode.

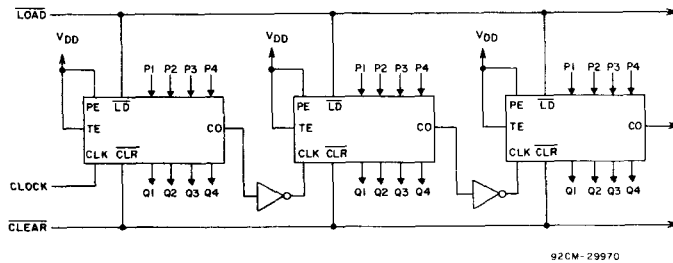

Fig. 19 — Cascaded counter packages in the ripple-clocked mode.

# CMOS Hex 'D'-Type Flip-Flop

## High-Voltage Types (20-Volt Rating)

The RCA-CD40174B consists of six identical 'D'-type flip-flops having independent DATA inputs. The CLOCK and CLEAR inputs are common to all six units. Data is transferred to the Q outputs on the positive-going transition of the clock pulse. All six flip-flops are simultaneously reset by a low level on the CLEAR input.

The CD40174B types are supplied in 16-lead hermetic dual-in-line ceramic packages (D and F suffixes), 16-lead dual-in-line plastic packages (E suffix), 16-lead ceramic flat packages (K suffix), and in chip form (H suffix).

### Features:

- 5-V, 10-V, and 15-V parametric rating
- Standardized symmetrical output characteristics
- 100% tested for quiescent current at 20 V
- Maximum input current of 1  $\mu$ A at 18 V over full package-temperature range; 100 nA at 18 V and 25°C
- Noise margin (over full package-temperature range): 1 V at  $V_{DD} = 5$  V  
2 V at  $V_{DD} = 10$  V  
2.5 V at  $V_{DD} = 15$  V
- Meets all requirements of JEDEC Tentative Standard No. 13A, "Standard Specifications for Description of 'B' Series CMOS Devices"

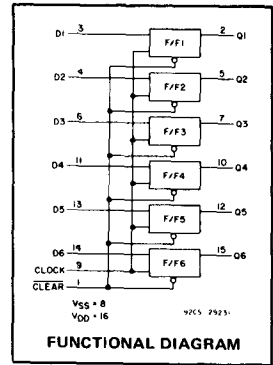

### MAXIMUM RATINGS, Absolute-Maximum Values:

DC SUPPLY-VOLTAGE RANGE, ( $V_{DD}$ ) (Voltages referenced to $V_{SS}$ Terminal)	-0.5 to +20 V
INPUT VOLTAGE RANGE, ALL INPUTS	-0.5 to $V_{DD} + 0.5$ V
DC INPUT CURRENT, ANY ONE INPUT	$\pm 10$ mA
POWER DISSIPATION PER PACKAGE ( $P_D$ ):	
For $T_A = -40$ to $+60^\circ\text{C}$ (PACKAGE TYPE E)	500 mW
For $T_A = +60$ to $+85^\circ\text{C}$ (PACKAGE TYPE E)	Derate Linearly at 12 mW/ $^\circ\text{C}$ to 200 mW
For $T_A = -55$ to $+100^\circ\text{C}$ (PACKAGE TYPES D, F, K)	500 mW
For $T_A = +100$ to $+125^\circ\text{C}$ (PACKAGE TYPES D, F, K)	Derate Linearly at 12 mW/ $^\circ\text{C}$ to 200 mW
DEVICE DISSIPATION PER OUTPUT TRANSISTOR:	
For $T_A = \text{FULL PACKAGE-TEMPERATURE RANGE (All Package Types)}$	100 mW
OPERATING-TEMPERATURE RANGE ( $T_A$ ):	
PACKAGE TYPES D, F, K, H	-55 to $+125^\circ\text{C}$
PACKAGE TYPE E	-40 to $+85^\circ\text{C}$
STORAGE TEMPERATURE RANGE ( $T_{stg}$ )	-65 to $+150^\circ\text{C}$
LEAD TEMPERATURE (DURING SOLDERING):	
At distance 1/16 $\pm$ 1/32 inch (1.59 $\pm$ 0.79 mm) from case for 10 s max.	$+265^\circ\text{C}$

### Applications:

- Shift Registers
- Buffer/Storage Registers
- Pattern Generators

### TRUTH TABLE FOR 1 OF 6 FLIP-FLOPS

CLOCK	INPUTS		OUTPUT
	DATA	CLEAR	
	0	1	0
	1	1	1
	X	1	NC
X	X	0	0

1 = High Level  
0 = Low Level  
X = Don't Care  
NC = No Change

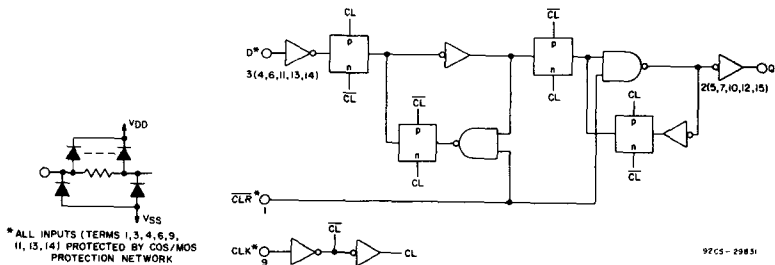

Fig. 1 - Logic diagram (1 of 6 flip-flops).

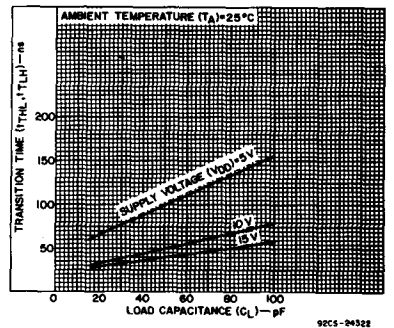

Fig. 2 - Typical transition time as a function of load capacitance.

# CD40174B Types

**RECOMMENDED OPERATING CONDITIONS** at  $T_A = 25^\circ\text{C}$ , Except as Noted.

For maximum reliability, nominal operating conditions should be selected so that operation is always within the following ranges:

CHARACTERISTIC	V <sub>DD</sub> (V)	LIMITS		UNITS
		Min.	Max.	
Supply-Voltage Range (For $T_A =$ Full Package-Temperature Range)	—	3	18	V
Data Setup Time, $t_{SU}$	5 10 15	40 20 10	— — —	ns
Data Hold Time, $t_H$	5 10 15	80 40 30	— — —	ns
Clock Input Frequency, $f_{CL}$	5 10 15	— dc —	3.5 6 8	MHz
Clock Input Rise or Fall Time, $t_{rCL}$ , $t_{fCL}$	5 10 15	— — —	15 15 15	$\mu\text{s}$
Clock Input Pulse Width, $t_{WL}$ , $t_{WH}$	5 10 15	130 60 40	— — —	ns
Clear Pulse Width, $t_{WL}$	5 10 15	100 50 40	— — —	ns
Clear Removal Time, $t_{REM}$	5 10 15	0 0 0	— — —	ns

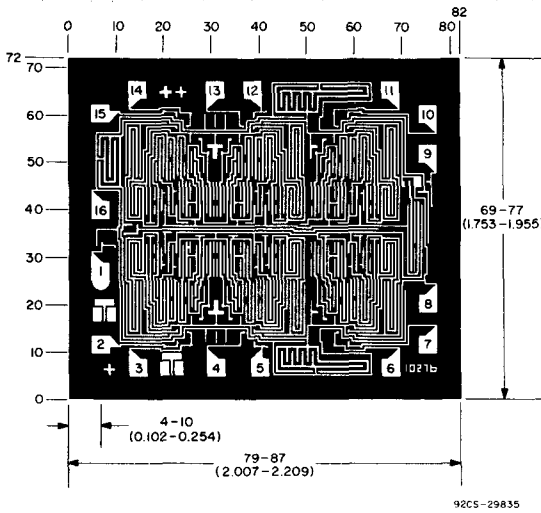

Dimensions and pad layout for CD40174BH.

Dimensions in parentheses are in millimeters and are derived from the basic inch dimensions as indicated. Grid graduations are in mils ( $10^{-3}$  inch).

The photographs and dimensions of each CMOS chip represent a chip when it is part of the wafer. When the wafer is separated into individual chips, the angle of cleavage may vary with respect to the chip face for different chips. The actual dimensions of the isolated chip, therefore, may differ slightly from the nominal dimensions shown. The user should consider a tolerance of  $-3$  mils to  $+16$  mils applicable to the nominal dimensions shown.

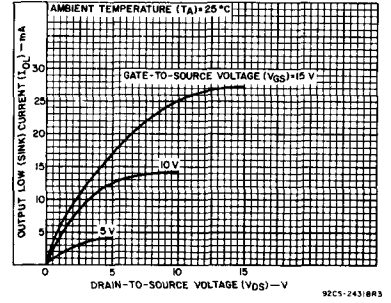

Fig. 3— Typical output low (sink) current characteristics.

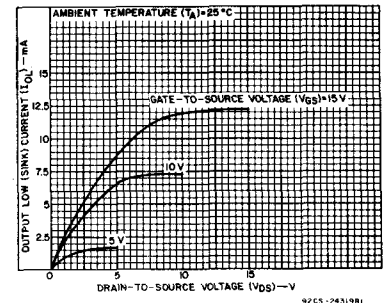

Fig. 4— Minimum output low (sink) current characteristics.

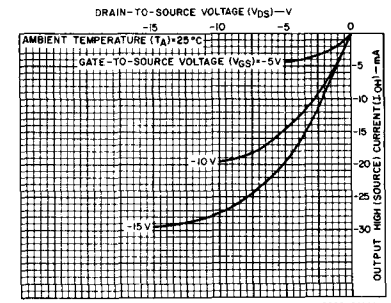

Fig. 5— Typical output high (source) current characteristics.

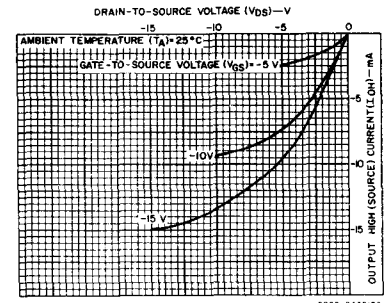

Fig. 6— Minimum output high (source) current characteristics.



# CD40174B Types

## STATIC ELECTRICAL CHARACTERISTICS

CHARACTERISTIC	CONDITIONS			LIMITS AT INDICATED TEMPERATURES (°C)							UNITS
	V <sub>O</sub> (V)	V <sub>IN</sub> (V)	V <sub>DD</sub> (V)	Values at -55, +25, +125 Apply to D, F, K, H Packages				Values at -40, +25, +85 Apply to E Package			
				-55	-40	+85	+125	+25			
								Min.	Typ.	Max.	
Quiescent Device Current, I <sub>DD</sub> Max.	-	0,5	5	1	1	30	30	-	0.02	1	μA
	-	0,10	10	2	2	60	60	-	0.02	2	
	-	0,15	15	4	4	120	120	-	0.02	4	
	-	0,20	20	20	20	600	600	-	0.04	20	
Output Low (Sink) Current I <sub>OL</sub> Min.	0.4	0,5	5	0.64	0.61	0.42	0.36	0.51	1	-	mA
	0.5	0,10	10	1.6	1.5	1.1	0.9	1.3	2.6	-	
	1.5	0,15	15	4.2	4	2.8	2.4	3.4	6.8	-	
Output High (Source) Current, I <sub>OH</sub> Min.	4.6	0,5	5	-0.64	-0.61	-0.42	-0.36	-0.51	-1	-	mA
	2.5	0,5	5	-2	-1.8	-1.3	-1.15	-1.6	-3.2	-	
	9.5	0,10	10	-1.6	-1.5	-1.1	-0.9	-1.3	-2.6	-	
Output Voltage: Low-Level, V <sub>OL</sub> Max.	-	0,5	5	0.05				-	0	0.05	V
	-	0,10	10	0.05				-	0	0.05	
	-	0,15	15	0.05				-	0	0.05	
Output Voltage: High-Level, V <sub>OH</sub> Min.	-	0,5	5	4.95				4.95	5	-	V
	-	0,10	10	9.95				9.95	10	-	
	-	0,15	15	14.95				14.95	15	-	
Input Low Voltage, V <sub>IL</sub> Max.	0.5, 4.5	-	5	1.5				-	-	1.5	V
	1.9	-	10	3				-	-	3	
	1.5, 13.5	-	15	4				-	-	4	
Input High Voltage, V <sub>IH</sub> Min.	0.5, 4.5	-	5	3.5				3.5	-	-	V
	1.9	-	10	7				7	-	-	
	1.5, 13.5	-	15	11				11	-	-	
Input Current I <sub>IN</sub> Max.	-	0,18	18	±0.1	±0.1	±1	±1	-	±10 <sup>-5</sup>	±0.1	μA

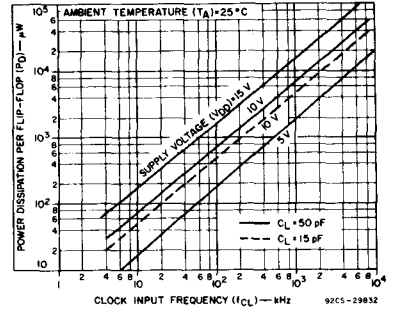

Fig. 7—Typical dynamic power dissipation as a function of CLOCK frequency.

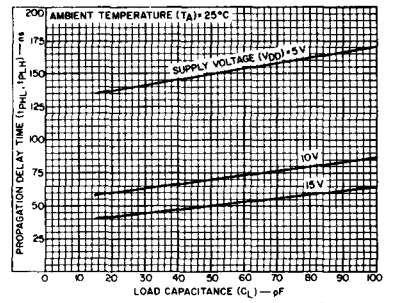

Fig. 8—Typical propagation delay time (CLOCK to OUTPUT) as a function of load capacitance.

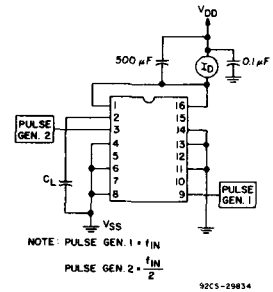

Fig. 9—Dynamic power dissipation test circuit.

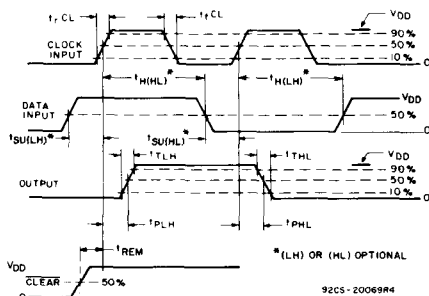

Fig. 10—Definition of setup, hold, propagation delay, and removal times.

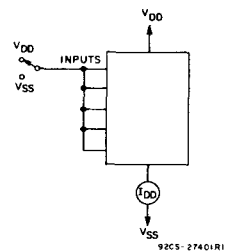

Fig. 11—Quiescent device current test circuit.

# CD40174B Types

DYNAMIC ELECTRICAL CHARACTERISTICS at  $T_A = 25^\circ\text{C}$ ;  
 Input  $t_r, t_f = 20\text{ ns}$ ,  $C_L = 50\text{ pF}$ ,  $R_L \approx 200\text{ k}\Omega$

CHARACTERISTIC	TEST CONDITIONS $V_{DD}$ (V)	LIMITS			UNITS
		Min.	Typ.	Max.	
Propagation Delay Time Clock to Output, $t_{PHL}, t_{PLH}$	5	—	150	300	ns
	10	—	70	140	
	15	—	50	100	
Clear to Output, $t_{PHL}$	5	—	100	200	ns
	10	—	50	100	
	15	—	40	80	
Transition Time, $t_{THL}, t_{TLH}$	5	—	100	200	ns
	10	—	50	100	
	15	—	40	80	
Minimum Pulse Width, Clock, $t_{WL}, t_{WH}$	5	—	65	130	ns
	10	—	30	60	
	15	—	20	40	
Clear, $t_{WL}$	5	—	50	100	ns
	10	—	25	50	
	15	—	20	40	
Minimum Data Setup Time, $t_{SU}$	5	—	20	40	ns
	10	—	10	20	
	15	—	0	10	
Minimum Data Hold Time, $t_H$	5	—	40	80	ns
	10	—	20	40	
	15	—	15	30	
Maximum Clock Frequency, $f_{CL}$	5	3.5	7	—	MHz
	10	6	12	—	
	15	8	16	—	
Maximum Clock Rise or Fall Time, $t_{rCL}, t_{fCL}$	5	15	—	—	$\mu\text{s}$
	10	15	—	—	
	15	15	—	—	
Input Capacitance, $C_{iN}$	Clear	—	25	40	pF
	All other	—	5	7.5	
Minimum Clear Removal Time, $t_{REM}$	5	—	-40	0	ns
	10	—	-15	0	
	15	—	-10	0	

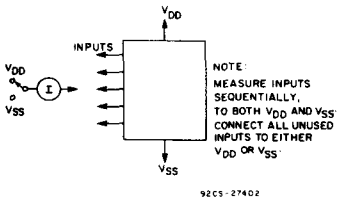

Fig. 12 — Input current test circuit.

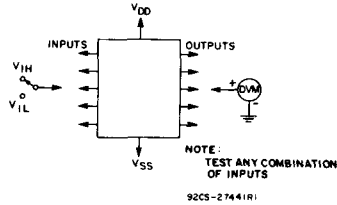
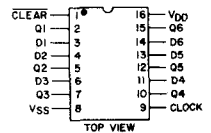

Fig. 13 — Input voltage test circuit.

## TERMINAL ASSIGNMENT



# CMOS Quad 'D'-Type Flip-Flop

## High-Voltage Types (20-Volt Rating)

### Features:

- 100% tested for quiescent current at 20 V
- Maximum input current of 1  $\mu$ A at 18 V over full package-temperature range; 100 nA at 18 V and 25°C
- Noise margin (full package-temperature range) =  
 1 V at  $V_{DD} = 5$  V  
 2 V at  $V_{DD} = 10$  V  
 2.5 V at  $V_{DD} = 15$  V
- 5-V, 10-V, and 15-V parametric ratings

- Meets all requirements of JEDEC Tentative Standard No. 13B, "Standard Specifications for Description of 'B' Series CMOS Devices"
- Output compatible with two HTL loads, two low power TTL loads, or one low power Schottky TTL load
- Functional equivalent to TTL 74175
- Standardized symmetrical output characteristics

### Applications:

- Shift registers
- Buffer/storage registers
- Pattern generators

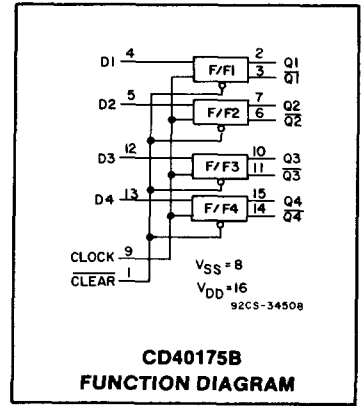

The RCA CD40175B consists of four identical D-type flip-flops. Each flip-flop has an independent DATA D input and complementary Q and  $\bar{Q}$  outputs. The CLOCK and CLEAR inputs are common to all flip-flops. Data are transferred to the Q outputs on the positive-going transition of the clock pulse. All four flip-flops are simultaneously reset by a low level on the CLEAR input.

These devices can function as shift register elements or as T-type flip-flops for toggle and counter applications.

The CD40175B is supplied in hermetic dual-in-line ceramic packages (D and F suffixes), 16-lead dual-in-line plastic packages (E suffix), 16-lead ceramic flat packages (K suffix), and in chip form (H suffix).

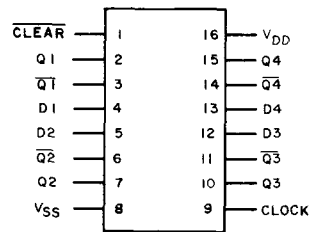

$V_{DD}$  = PIN 16  
 $V_{SS}$  = PIN 8

### TERMINAL ASSIGNMENT

### MAXIMUM RATINGS, Absolute-Maximum Values:

DC SUPPLY-VOLTAGE RANGE, ( $V_{DD}$ ) (Voltages referenced to $V_{SS}$ Terminal)	-0.5 to $V_{DD} + 20$ V
INPUT VOLTAGE RANGE, ALL INPUTS	-0.5 to $V_{DD} + 0.5$ V
DC INPUT CURRENT, ANY ONE INPUT	$\pm 10$ mA
POWER DISSIPATION PER PACKAGE ( $P_D$ ):	
For $T_A = -40$ to $+60^\circ\text{C}$ (PACKAGE TYPE E)	500 mW
For $T_A = +60$ to $+85^\circ\text{C}$ (PACKAGE TYPE E)	Derate Linearly at 12 mW/ $^\circ\text{C}$ to 200 mW
For $T_A = -55$ to $+100^\circ\text{C}$ (PACKAGE TYPES D, F, K)	500 mW
For $T_A = +100$ to $+125^\circ\text{C}$ (PACKAGE TYPES D, F, K)	Derate Linearly at 12 mW/ $^\circ\text{C}$ to 200 mW
DEVICE DISSIPATION PER OUTPUT TRANSISTOR: For $T_A = \text{FULL PACKAGE-TEMPERATURE RANGE (All Package Types)}$	100 mW
OPERATING-TEMPERATURE RANGE ( $T_A$ ):	
PACKAGE TYPES D, F, K, H	-55 to $+125^\circ\text{C}$
PACKAGE TYPE E	-40 to $+85^\circ\text{C}$
STORAGE TEMPERATURE RANGE ( $T_{stg}$ )	-65 to $+150^\circ\text{C}$
LEAD TEMPERATURE (DURING SOLDERING): At distance $1/16 \pm 1/32$ inch ( $1.59 \pm 0.79$ mm) from case for 10 s max.	$+265^\circ\text{C}$

# CD40175B Types

**RECOMMENDED OPERATING CONDITIONS** at  $T_A = 25^\circ\text{C}$ , Except as Noted.

For maximum reliability, nominal operating conditions should be selected so that operation is always within the following ranges:

CHARACTERISTIC	$V_{DD}$ (V)	LIMITS		UNITS
		MIN.	MAX.	
Supply-Voltage Range (For $T_A =$ Full Package-Temperature Range)	—	3	18	V
Data Setup Time	5 10 15	120 50 40	— — —	ns
Data Hold Time	5 10 15	80 40 30	— — —	ns
Clock Input Frequency	5 10 15	— dc —	2 5 6.5	MHz
Clock Input Rise or Fall Time	5 10 15	— — —	15 15 15	$\mu\text{s}$
Clock Input Pulse Width	5 10 15	250 100 75	— — —	ns
$\overline{\text{Clear}}$ Pulse Width	5 10 15	200 80 60	— — —	ns
$\overline{\text{Clear}}$ Removal Time	5 10 15	250 100 80	— — —	ns

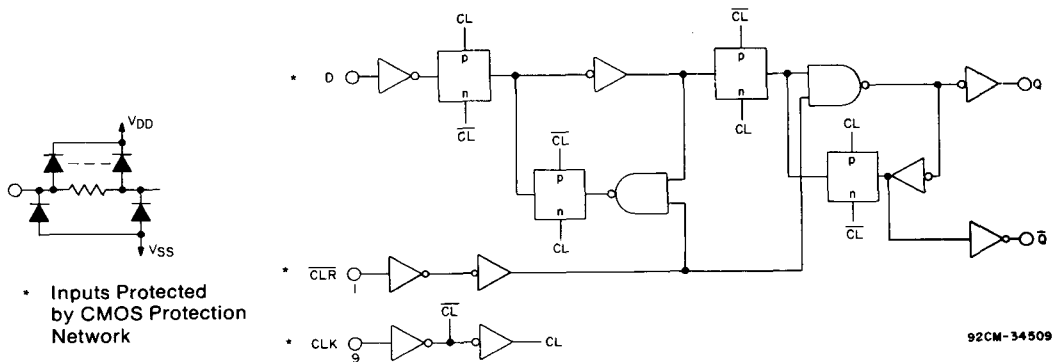

Fig. 1 - Logic diagram (1 of 4 flip-flops).

STATIC ELECTRICAL CHARACTERISTICS

CD40175B Types

CHARACTERISTIC	CONDITIONS			LIMITS AT INDICATED TEMPERATURES (°C)							UNITS			
				Values at -55, +25, +125 Apply to D, F, K, H Packages								+25		
				Vo (V)	VIN (V)	VDD (V)	-55	-40	+85	+125		Min.	Typ.	Max.
Quiescent Device Current Max. IDD	—	0, 5	5	1	1	30	30	—	0.02	1	μA			
	—	0, 10	10	2	2	60	60	—	0.02	2				
	—	0, 15	15	4	4	120	120	—	0.02	4				
Output Low (Sink) Current Min. IOL	0.4	0, 5	5	0.64	0.61	0.42	0.36	0.51	1	—	mA			
	0.5	0, 10	10	1.6	1.5	1.1	0.9	1.3	2.6	—				
	1.5	0, 15	15	4.2	4	2.8	2.4	3.4	6.8	—				
Output High (Source) Current Min. IOH	4.6	0, 5	5	-0.64	-0.61	-0.42	-0.36	-0.51	-1	—	mA			
	2.5	0, 5	5	-2	-1.8	-1.3	-1.15	-1.6	-3.2	—				
	9.5	0, 10	10	-1.6	-1.5	-1.1	-0.9	-1.3	-2.6	—				
Output Voltage: Low-Level Max. VOL	—	0, 5	5	0.05				—	0	0.05	V			
	—	0, 10	10	0.05				—	0	0.05				
	—	0, 15	15	0.05				—	0	0.05				
Output Voltage: High-Level Min. VOH	—	0, 5	5	4.95				4.95	5	—	V			
	—	0, 10	10	9.95				9.95	10	—				
	—	0, 15	15	14.95				14.95	15	—				
Input Low Voltage Max. VIL	0.5, 4.5	—	5	1.5				—	—	1.5	V			
	1, 9	—	10	3				—	—	3				
	1.5, 13.5	—	15	4				—	—	4				
Input High Voltage Min. VIH	0.5, 4.5	—	5	3.5				3.5	—	—	V			
	1, 9	—	10	7				7	—	—				
	1.5, 13.5	—	15	11				11	—	—				
Input Current Max. IIN	—	0, 18	18	±0.1	±0.1	±1	±1	—	±10 <sup>-5</sup>	±0.1	μA			

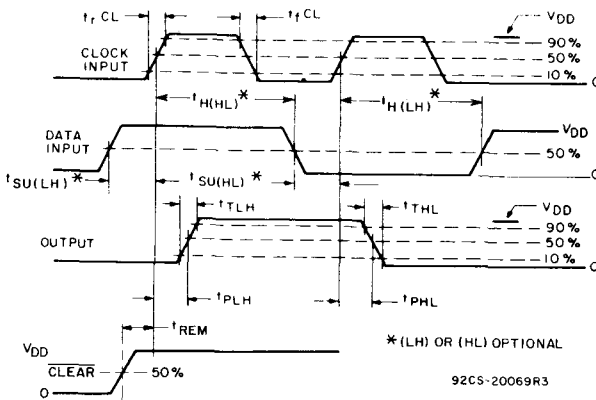

Fig. 2 - Definition of setup, hold, propagation delay, and removal times.

TRUTH TABLE FOR 1 OF 4 FLIP-FLOPS (Positive Logic)

INPUTS			OUTPUTS	
CLOCK	DATA	CLEAR	Q	Q̄
—	0	1	0	1
—	1	1	1	0
—	X	1	Q	Q̄
X	X	0	0	1

1=High Level X=Don't Care 0=Low Level

92CS-20069R3

# CD40175B Types

DYNAMIC ELECTRICAL CHARACTERISTICS at  $T_A = 25^\circ\text{C}$ ; Input  $t_r, t_f = 20\text{ ns}$ ,  $C_L = 50\text{ pF}$ ,  $R_L = 200\text{ k}\Omega$

CHARACTERISTIC	TEST CONDITIONS	V <sub>DD</sub> (V)	LIMITS			UNITS
			MIN.	TYP.	MAX.	
Transition Time	t <sub>THL</sub> , t <sub>TLH</sub>	5	—	100	200	ns
		10	—	50	100	
		15	—	40	80	
Propagation Delay Time Clock to Q Output	t <sub>PHL</sub> , t <sub>PLH</sub>	5	—	220	400	
		10	—	90	160	
		15	—	70	120	
Propagation Delay Time CLEAR to Q Output	t <sub>PHL</sub>	5	—	325	500	
		10	—	130	200	
		15	—	100	150	
Minimum Pulse Width Clock	t <sub>WH</sub>	5	—	110	250	
		10	—	45	100	
		15	—	35	75	
Clear	t <sub>WL</sub>	5	—	100	200	
		10	—	40	80	
		15	—	30	60	
Maximum Clock Frequency	f <sub>CL</sub>	5	2	4.5	—	MHz
		10	5	11	—	
		15	6.5	14	—	
Maximum Clock Rise or Fall Time	t <sub>rCL</sub> , t <sub>fCL</sub>	5	15	—	—	$\mu\text{s}$
		10	15	—	—	
		15	15	—	—	
Minimum Data Setup Time	t <sub>SU</sub>	5	—	60	120	ns
		10	—	25	50	
		15	—	20	40	
Minimum Data Hold Time	t <sub>H</sub>	5	—	40	80	
		10	—	20	40	
		15	—	15	30	
Minimum Clear Removal Time ‡	t <sub>REM</sub>	5	—	125	250	
		10	—	50	100	
		15	—	40	80	
Input Capacitance	C <sub>IN</sub>	—	—	5	7.5	pF

‡ CLEAR signal must be high prior to positive-going transition of CLOCK pulse.

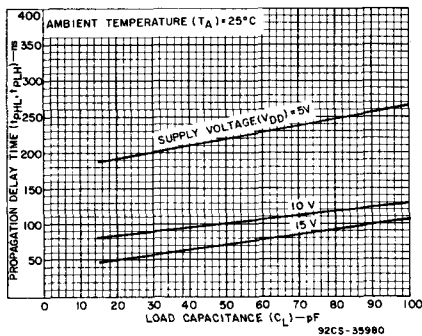

Fig. 3 - Typical propagation delay time (CLOCK to OUTPUT) as a function of load capacitance.

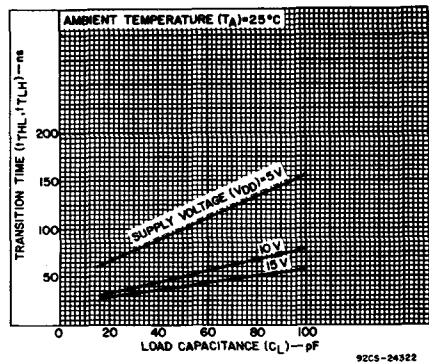

Fig. 4 - Typical transition time as a function of load capacitance.

# CD40175B Types

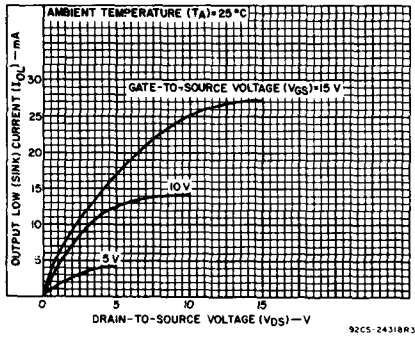

Fig. 5 - Typical output low (sink) current characteristics.

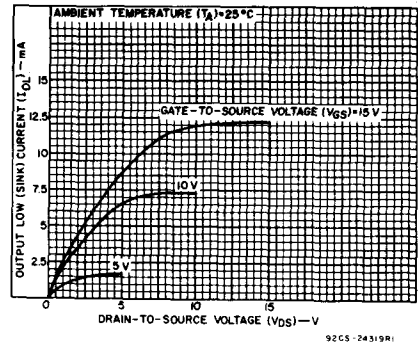

Fig. 6 - Minimum output low (sink) current characteristics.

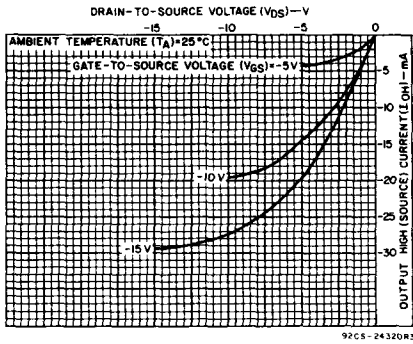

Fig. 7 - Typical output high (source) current characteristics.

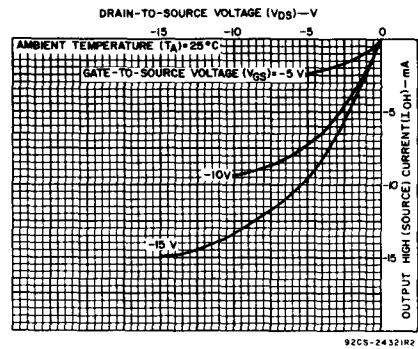

Fig. 8 - Minimum output high (source) current characteristics.

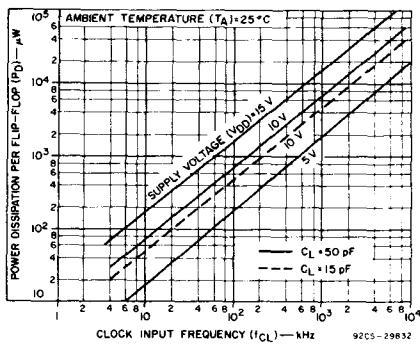

Fig. 9 - Typical dynamic power dissipation as a function of CLOCK frequency.

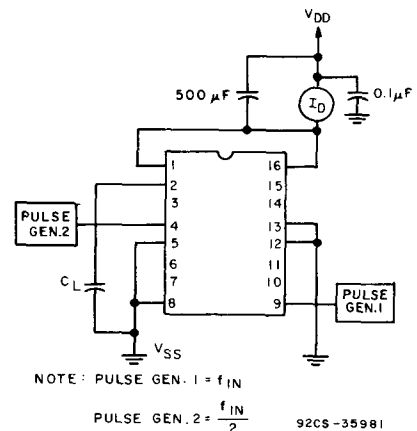

Fig. 10 - Dynamic power dissipation test circuit.

# CD40175B Types

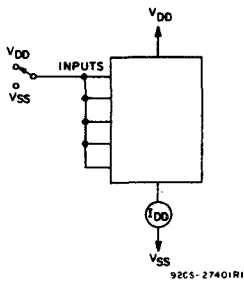

Fig. 11 - Quiescent device current test circuit.

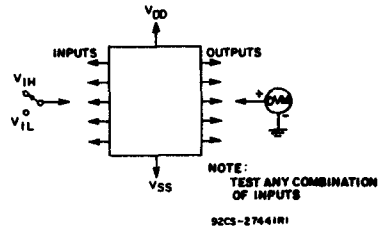

Fig. 12 - Noise immunity test circuit.

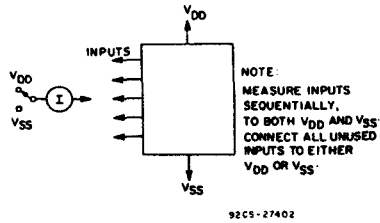
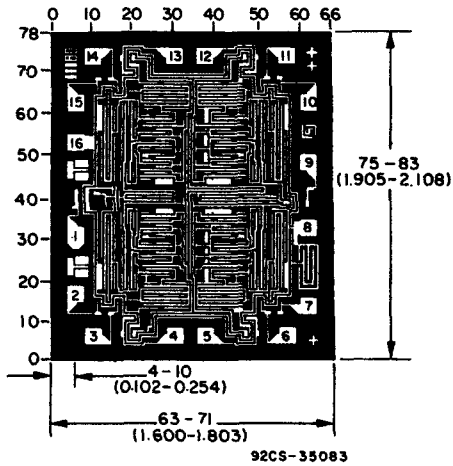

Fig. 13 - Input leakage current test circuit.



### Dimensions and pad layout for CD40175BH.

Dimensions in parentheses are in millimeters and are derived from the basic inch dimensions as indicated. Grid graduations are in mils ( $10^{-3}$  inch).

The photographs and dimensions of each CMOS chip represent a chip when it is part of the wafer. When the wafer is separated into individual chips, the angle of cleavage may vary with respect to the chip face for different chips. The actual dimensions of the isolated chip, therefore, may differ slightly from the nominal dimensions shown. The user should consider a tolerance  $-3$  mils to  $+16$  mils applicable to the nominal dimensions shown.



# CMOS 4-Bit Arithmetic Logic Unit

High-Voltage Types (20-Volt Rating)

The RCA-CD40181B is a low-power four-bit parallel arithmetic logic unit (ALU) capable of providing 16 binary arithmetic operations on two four-bit words and 16 logical functions of two Boolean variables. The mode control input M selects logical (M = High) or arithmetic (M = Low) operation. The four select inputs (S0, S1, S2, and S3) select the desired logical or arithmetic functions, which include AND, OR, NAND, NOR, and exclusive-OR and -NOR in the logic mode, and addition, subtraction, decrement, left-shift and straight transfer in the arithmetic mode, according to the truth table. The CD40181B operation may be interpreted with either active-low or active-high data at the A and B word inputs and the function outputs F, by using the appropriate truth table.

The CD40181B contains logic for full look-ahead carry operation for fast carry generation using the carry-generate and carry-propagate outputs  $\bar{G}$  and  $\bar{P}$  for the four bits of the CD40181B. Use of the CD40182B look-ahead carry generator in conjunction with multiple CD40181B'S permits high-speed arithmetic operations on long words. A ripple carry output  $C_{n+4}$  is available for use in systems where speed is not of primary importance.

Also included in the CD40181B is a comparator output A = B, which assumes a high level whenever the two four-bit input words A and B are equal and the device is in the subtract mode. In addition, relative magnitude information may be derived from the carry-in input  $C_n$  and ripple carry-out output  $C_{n+4}$  by placing the unit in the subtract mode and externally decoding using the information in Table III.

The CD40181B types are supplied in 24-lead hermetic ceramic dual-in-line packages (D and F suffixes), 24-lead dual-in-line plastic packages (E suffix), 24-lead ceramic flat packages (K suffix), and in chip form (H suffix).

The CD40181 is similar to industry types MC14581 and 74181.

### RECOMMENDED OPERATING CONDITIONS

For maximum reliability, nominal operating conditions should be selected so that operation is always within the following ranges:

CHARACTERISTIC	LIMITS		UNITS
	Min.	Max.	
Supply-Voltage Range (For $T_A$ = Full Package-Temperature Range)	3	18	V

### Features:

- Full look-ahead carry for speed operations on long words
- Generates 16 logic functions of two Boolean variables
- Generates 16 arithmetic functions of two 4-bit binary words
- A = B comparator output available
- Ripple-carry input and output available
- Typical addition time 200 ns @  $V_{DD} = 10$  V
- Standardized, symmetrical output characteristics
- 100% tested for quiescent current at 20 V
- Maximum input current of 1  $\mu$ A at 18 V over full package temperature range; 100 nA at 18 V and 25°C
- Noise margin (full package temperature range)
  - = 1 V at  $V_{DD} = 5$  V
  - = 2 V at  $V_{DD} = 10$  V
  - = 2.5 V at  $V_{DD} = 15$  V
- 5-V, 10-V, and 15-V parametric ratings
- Meets all requirements of JEDEC Tentative Standard No. 13A, "Standard Specifications for Description of 'B' Series CMOS Devices"

### Applications:

- Parallel arithmetic units
- Process controllers
- Low-power minicomputers

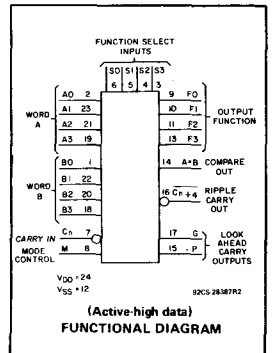
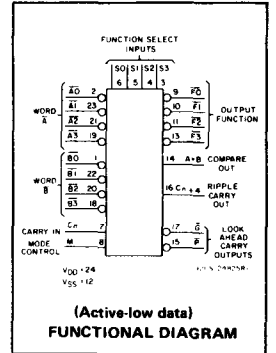

### MAXIMUM RATINGS, Absolute-Maximum Values:

- DC SUPPLY-VOLTAGE RANGE, ( $V_{DD}$ ) (Voltages referenced to  $V_{SS}$  Terminal) ..... -0.5 to +20 V
- INPUT VOLTAGE RANGE, ALL INPUTS ..... -0.5 to  $V_{DD} + 0.5$  V
- DC INPUT CURRENT, ANY ONE INPUT .....  $\pm 10$  mA
- POWER DISSIPATION PER PACKAGE ( $P_D$ ):
  - For  $T_A = -40$  to  $+60^\circ\text{C}$  (PACKAGE TYPE E) ..... 500 mW
  - For  $T_A = +60$  to  $+85^\circ\text{C}$  (PACKAGE TYPE E) ..... Derate Linearly at 12 mW/ $^\circ\text{C}$  to 200 mW
  - For  $T_A = -55$  to  $+100^\circ\text{C}$  (PACKAGE TYPES D, F, K) ..... 500 mW
  - For  $T_A = +100$  to  $+125^\circ\text{C}$  (PACKAGE TYPES D, F, K) ..... Derate Linearly at 12 mW/ $^\circ\text{C}$  to 200 mW
- DEVICE DISSIPATION PER OUTPUT TRANSISTOR:
  - For  $T_A = \text{FULL PACKAGE-TEMPERATURE RANGE}$  (All Package Types) ..... 100 mW
- OPERATING-TEMPERATURE RANGE ( $T_A$ ):
  - PACKAGE TYPES D, F, K, H ..... -55 to  $+125^\circ\text{C}$
  - PACKAGE TYPE E ..... -40 to  $+85^\circ\text{C}$
- STORAGE TEMPERATURE RANGE ( $T_{stg}$ ) ..... -65 to  $+150^\circ\text{C}$
- LEAD TEMPERATURE (DURING SOLDERING):
  - At distance  $1/16 \pm 1/32$  inch ( $1.59 \pm 0.79$  mm) from case for 10 s max. ....  $+265^\circ\text{C}$

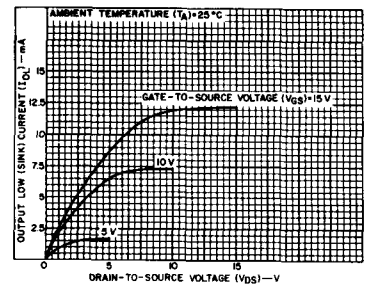
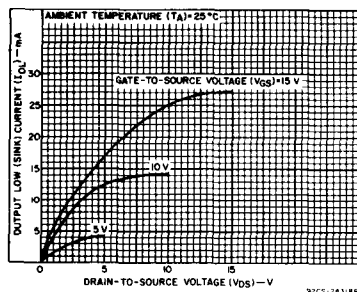

# CD40181B Types

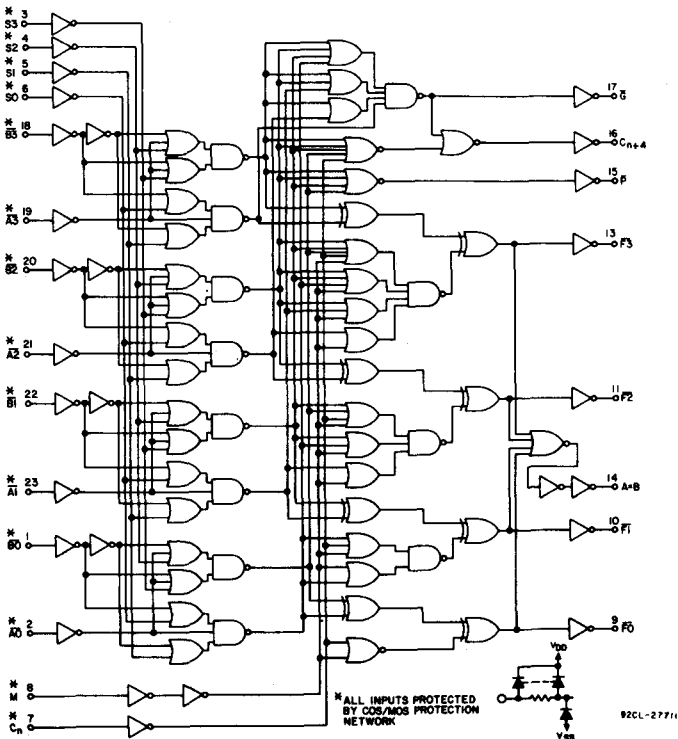

Fig. 3 - CD40181B logic diagram (active-low data).

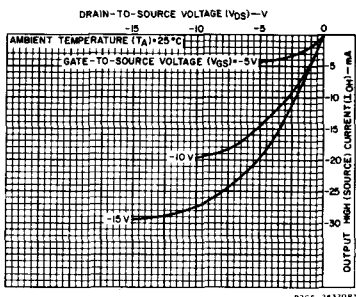

Fig. 4 - Typical output high (source) current characteristics.

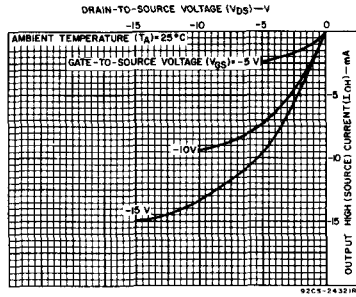

Fig. 5 - Minimum output high (source) current characteristics.

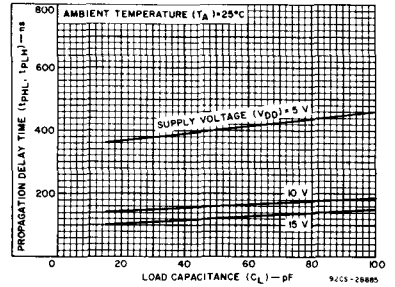

Fig. 6 - Typical propagation delay time as a function of load capacitance (for A or B to F, logic mode).

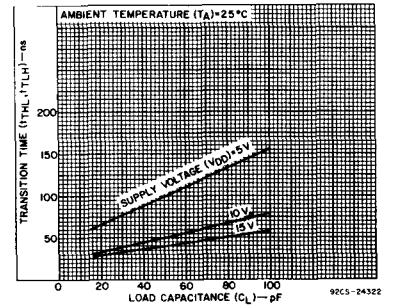

Fig. 7 - Typical transition time as a function of load capacitance.

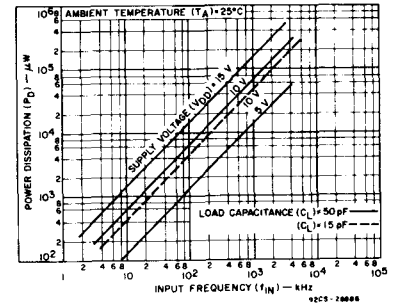

Fig. 8 - Typical dynamic dissipation as a function of input frequency (see Fig. 11 - dynamic power dissipation test circuit).

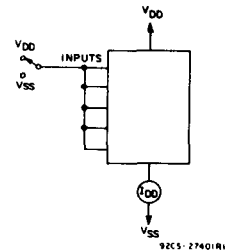

Fig. 9 - Quiescent-device-current test circuit.

# CD40181B Types

## STATIC ELECTRICAL CHARACTERISTICS

CHARACTERISTIC	CONDITIONS			LIMITS AT INDICATED TEMPERATURES (°C)							UNITS
	V <sub>O</sub> (V)	V <sub>IN</sub> (V)	V <sub>DD</sub> (V)	-55			+25			Max.	
				-40	+85	+125	Min.	Typ.			
Quiescent Device Current, I <sub>DD</sub> Max.	-	0,5	5	5	5	150	150	-	0,04	5	μA
	-	0,10	10	10	10	300	300	-	0,04	10	
	-	0,15	15	20	20	600	600	-	0,04	20	
	-	0,20	20	100	100	3000	3000	-	0,08	100	
Output Low (Sink) Current I <sub>OL</sub> Min.	0,4	0,5	5	0,64	0,61	0,42	0,36	0,51	1	-	mA
	0,5	0,10	10	1,6	1,5	1,1	0,9	1,3	2,6	-	
	1,5	0,15	15	4,2	4	2,8	2,4	3,4	6,8	-	
Output High (Source) Current, I <sub>OH</sub> Min.	4,6	0,5	5	-0,64	-0,61	-0,42	-0,36	-0,51	-1	-	mA
	2,5	0,5	5	-2	-1,8	-1,3	-1,15	-1,6	-3,2	-	
	9,5	0,10	10	-1,6	-1,5	-1,1	-0,9	-1,3	-2,6	-	
	13,5	0,15	15	-4,2	-4	-2,8	-2,4	-3,4	-6,8	-	
Output Voltage: Low-Level, V <sub>OL</sub> Max.	-	0,5	5	0,05			-			0	V
	-	0,10	10	0,05			-			0	
	-	0,15	15	0,05			-			0	
Output Voltage: High-Level, V <sub>OH</sub> Min.	-	0,5	5	4,95			4,95			5	V
	-	0,10	10	9,95			9,95			10	
	-	0,15	15	14,95			14,95			15	
Input Low Voltage, V <sub>IL</sub> Max.	0,5, 4,5	-	5	1,5			-			1,5	V
	1,9	-	10	3			-			3	
	1,5, 13,5	-	15	4			-			4	
Input High Voltage, V <sub>IH</sub> Min.	0,5, 4,5	-	5	3,5			3,5			-	V
	1,9	-	10	7			7			-	
	1,5, 13,5	-	15	11			11			-	
Input Current I <sub>IN</sub> Max.	-	0,18	18	±0,1	±0,1	±1	±1	-	±10 <sup>-5</sup>	±0,1	μA

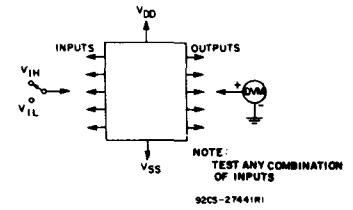
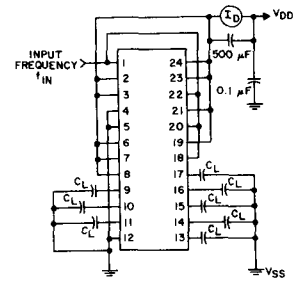

Fig. 10 - Input-voltage test circuit.



TEST CONDITIONS:  
A0, A1, A2, A3, S0, S3, M, C<sub>n</sub> = V<sub>DD</sub>  
B0, B1, B2, B3 = f<sub>IN</sub>  
S1, S2 = V<sub>SS</sub>  
(ALL OUTPUTS SWITCHING EXCEPT G)

92CS-24887

Fig. 11 - Dynamic power dissipation test circuit.

DYNAMIC ELECTRICAL CHARACTERISTICS at T<sub>A</sub> = 25°C; Input t<sub>r</sub>, t<sub>f</sub> = 20 ns, C<sub>L</sub> = 50 pF, R<sub>L</sub> = 200 kΩ

CHARACTERISTIC	V <sub>DD</sub> (V)	LIMITS		UNITS
		Typ.	Max.	
Propagation Delay Time: t <sub>pHL</sub> , t <sub>pLH</sub> A or B to F (logic mode), A or B to G or P,	5	400	800	ns
	10	160	320	
	15	120	240	
A or B to F, C <sub>n</sub> +4, or A = B,	5	500	1000	ns
	10	200	400	
	15	140	280	
C <sub>n</sub> to F	5	320	640	ns
	10	135	270	
	15	100	200	
C <sub>n</sub> to C <sub>n</sub> +4	5	200	400	ns
	10	100	200	
	15	70	140	
Transition Time: t <sub>THL</sub> , t <sub>TLH</sub>	5	100	200	ns
	10	50	100	
	15	40	80	
Input Capacitance, C <sub>IN</sub> (Any Input)	-	5	7.5	pF

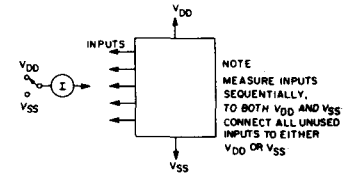
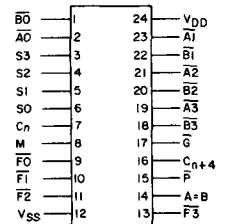

Fig. 12 - Input current test circuit.



Top View  
Terminal Assignment  
(Active-low Data)

# CD40181B Types

TABLE I  
TRUTH TABLE

FUNCTION SELECT				INPUTS/OUTPUT ACTIVE LOW		
				LOGIC FUNCTION M = H	ARITHMETIC* FUNCTION M = L	
					C <sub>n</sub> = L	C <sub>n</sub> = H
S3	S2	S1	S0			
0	0	0	0	$\overline{A}$	A minus 1	A
0	0	0	1	$\overline{A}\overline{B}$	AB minus 1	AB
0	0	1	0	$\overline{A} + B$	$\overline{A}\overline{B}$ minus 1	$\overline{A}\overline{B}$
0	0	1	1	Logic 1	minus 1	Zero
0	1	0	0	$\overline{A} + \overline{B}$	A plus (A + $\overline{B}$ )	A plus (A + $\overline{B}$ ) plus 1
0	1	0	1	$\overline{B}$	AB plus (A + $\overline{B}$ )	AB plus (A + $\overline{B}$ ) plus 1
0	1	1	0	$\overline{A} \oplus \overline{B}$	A minus B minus 1	A minus B
0	1	1	1	A + $\overline{B}$	A + $\overline{B}$	(A + $\overline{B}$ ) plus 1
1	0	0	0	$\overline{A}\overline{B}$	A plus (A + B)	A plus (A + B) plus 1
1	0	0	1	$\overline{A} \oplus B$	A plus B	A plus B plus 1
1	0	1	0	B	$\overline{A}\overline{B}$ plus (A + B)	$\overline{A}\overline{B}$ plus (A + B) plus 1
1	0	1	1	A + B	A + B	A + B plus 1
1	1	0	0	Logic 0	A plus A	A plus A plus 1
1	1	0	1	$\overline{A}\overline{B}$	AB plus A	AB plus A plus 1
1	1	1	0	AB	$\overline{A}\overline{B}$ plus A	$\overline{A}\overline{B}$ plus A plus 1
1	1	1	1	A	A	A plus 1

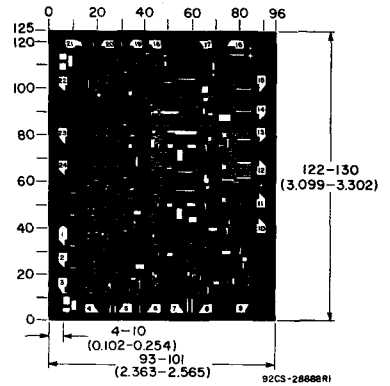

Dimensions and pad layout for CD40181BH.

Dimensions in parentheses are in millimeters and are derived from the basic inch dimensions as indicated. Grid graduations are in mils ( $10^{-3}$  inch).

The photographs and dimensions of each CMOS chip represent a chip when it is part of the wafer. When the wafer is separated into individual chips, the angle of cleavage may vary with respect to the chip face for different chips. The actual dimensions of the isolated chip, therefore, may differ slightly from the nominal dimensions shown. The user should consider a tolerance of  $-3$  mils to  $+16$  mils applicable to the nominal dimensions shown.

FUNCTION SELECT				INPUTS/OUTPUTS ACTIVE HIGH		
				LOGIC FUNCTION M = H	ARITHMETIC* FUNCTION M = L	
					C <sub>n</sub> = H	C <sub>n</sub> = L
S3	S2	S1	S0			
0	0	0	0	$\overline{A}$	A	A plus 1
0	0	0	1	$\overline{A} + B$	A + B	(A + B) plus 1
0	0	1	0	$\overline{A}\overline{B}$	A + $\overline{B}$	(A + $\overline{B}$ ) plus 1
0	0	1	1	Logic 0	minus 1	Zero
0	1	0	0	$\overline{A}\overline{B}$	A plus $\overline{A}\overline{B}$	A plus $\overline{A}\overline{B}$ plus 1
0	1	0	1	$\overline{B}$	(A + B) plus $\overline{A}\overline{B}$	(A + B) plus $\overline{A}\overline{B}$ plus 1
0	1	1	0	$\overline{A} \oplus B$	A minus B minus 1	A minus B
0	1	1	1	$\overline{A}\overline{B}$	$\overline{A}\overline{B}$ minus 1	$\overline{A}\overline{B}$
1	0	0	0	$\overline{A} + B$	A plus AB	A plus AB plus 1
1	0	0	1	$\overline{A} \oplus \overline{B}$	A plus B	A plus B plus 1
1	0	1	0	B	(A + $\overline{B}$ ) plus AB	(A + $\overline{B}$ ) plus AB plus 1
1	0	1	1	AB	AB minus 1	AB
1	1	0	0	Logic 1	A plus A	A plus A plus 1
1	1	0	1	A + $\overline{B}$	(A + B) plus A	(A + B) plus A plus 1
1	1	1	0	A + B	(A + $\overline{B}$ ) plus A	(A + $\overline{B}$ ) plus A plus 1
1	1	1	1	A	A minus 1	A

\* Expressed as two's complement.

1 = HIGH LEVEL

0 = LOW LEVEL

TABLE II  
AC TEST SETUP REFERENCE (ACTIVE-LOW DATA)

TEST DELAY TIMES	AC PATHS		DC DATA INPUTS		MODE*
	INPUTS	OUTPUTS	TO V <sub>SS</sub>	TO V <sub>DD</sub>	
SUM <sub>IN</sub> to SUM <sub>OUT</sub>	$\overline{B0}$	Any $\overline{F}$	$\overline{B1}, \overline{B2}, \overline{B3},$ M, C <sub>n</sub>	All $\overline{A}$ 's	ADD
SUM <sub>IN</sub> to $\overline{P}$	$\overline{A0}$	$\overline{P}$	$\overline{A1}, \overline{A2}, \overline{A3},$ M, C <sub>n</sub>	All $\overline{B}$ 's	ADD
SUM <sub>IN</sub> to $\overline{G}$	$\overline{B0}$	$\overline{G}$	All $\overline{A}$ 's M, C <sub>n</sub>	$\overline{B1}, \overline{B2}, \overline{B3}$	ADD
SUM <sub>IN</sub> to C <sub>n+4</sub>	$\overline{B0}$	C <sub>n+4</sub>	All $\overline{A}$ 's, M, C <sub>n</sub>	$\overline{B1}, \overline{B2}, \overline{B3}$	ADD
C <sub>n</sub> to SUM <sub>OUT</sub>	C <sub>n</sub>	Any $\overline{F}$	All $\overline{A}$ 's, M	All $\overline{U}$ 's	ADD
C <sub>n</sub> to C <sub>n+4</sub>	C <sub>n</sub>	C <sub>n+4</sub>	All $\overline{A}$ 's, M	All $\overline{B}$ 's	ADD
SUM <sub>IN</sub> to A = B	$\overline{B0}$	A = B	All $\overline{A}$ 's, $\overline{B1}, \overline{B2}, \overline{B3},$ M	C <sub>n</sub>	SUBTRACT
SUM <sub>IN</sub> to SUM <sub>OUT</sub> (Logic Mode)	All $\overline{B}$ 's	Any $\overline{F}$	All $\overline{A}$ 's, C <sub>n</sub>	M	EXCLUSIVE OR

\* ADD Mode: S<sub>0</sub>, S<sub>3</sub> = V<sub>DD</sub>; S<sub>1</sub>, S<sub>2</sub> = V<sub>SS</sub>.

SUBTRACT Mode: S<sub>0</sub>, S<sub>3</sub> = V<sub>SS</sub>; S<sub>1</sub>, S<sub>2</sub> = V<sub>DD</sub>.

TABLE III  
MAGNITUDE COMPARISON

ACTIVE - HIGH DATA			ACTIVE - LOW DATA		
INPUT C <sub>n</sub>	OUTPUT C <sub>n+4</sub>	MAGNITUDE	INPUT C <sub>n</sub>	OUTPUT C <sub>n+4</sub>	MAGNITUDE
1	1	A ≤ B	0	0	A ≤ B
0	1	A < B	1	0	A < B
1	0	A > B	0	1	A > B
0	0	A ≥ B	1	1	A ≥ B

1 = HIGH LEVEL  
0 = LOW LEVEL

## CD40182B Types

# CMOS Look-Ahead Carry Generator

High-Voltage Types (20-Volt Rating)

The RCA-CD40182B is a high-speed look-ahead carry generator capable of anticipating a carry across four binary adders or groups of adders. The CD40182B is cascadable to perform full look-ahead across n-bit adders. Carry, propagate-carry, and generate-carry functions are provided as enumerated in the terminal designation below.

The CD40182B, when used in conjunction with the CD40181B arithmetic logic unit (ALU), provides full high-speed look-ahead carry capability for up to n-bit words. Each CD40182B generates the look-ahead (anticipated carry) across a group of four ALU's. In addition, other CD40182B's may be employed to anticipate the carry across sections of four look-ahead blocks up to n-bits. Carry inputs and outputs of the CD40181B are active-high logic, and carry-generate (G) and carry-propagate (P) outputs are active-low. Therefore the inputs and outputs of the CD40182B are compatible.

The CD40182B types are supplied in 16-lead hermetic dual-in-line ceramic packages (D and F suffixes), 16-lead dual-in-line plastic packages (E suffix), 16-lead ceramic flat packages (K suffix), and in chip form (H suffix).

The CD40182B is similar to industry type MC14582.

### TERMINAL DESIGNATIONS

DESIGNATION	TERM.	FUNCTION
$\overline{G0}, \overline{G1}, \overline{G2}, \overline{G3}$	3, 1, 14, 5	Active-Low Carry-Generate Inputs
$\overline{P0}, \overline{P1}, \overline{P2}, \overline{P3}$	4, 2, 15, 6	Active-Low Carry-Propagate Inputs
$C_n$	13	Active-High Carry Input
$C_{n+x}, C_{n+y}, C_{n+z}$	12, 11, 9	Active-High Carry Outputs
$\overline{G}$	10	Active-Low Group Carry-Generate Output
$\overline{P}$	7	Active-Low Group Carry-Propagate Output

### Features:

- Generates high-speed carry across four adders or adder groups
- High-speed operations:  
 $t_{PHL} = t_{PLH} = 100 \text{ ns (typ.) @ } V_{DD} = 10 \text{ V}$
- Cascadable for fast carries over N bits
- Designed for use with CD40181B ALU
- 100% tested for quiescent current at 20 V
- 5-V, 10-V, and 15-V parametric ratings
- Standardized, symmetrical output characteristics
- Maximum input current of  $1 \mu\text{A}$  at 18 V over full package-temperature range; 100 nA at 18 V and 25°C
- Noise margin (full package-temperature range) =  
1 V at  $V_{DD} = 5 \text{ V}$   
2 V at  $V_{DD} = 10 \text{ V}$   
2.5 V at  $V_{DD} = 15 \text{ V}$
- Meets all requirements of JEDEC Tentative Standard No. 13A, "Standard Specifications for Description of 'B' Series CMOS Devices"

### Applications:

- High-speed parallel arithmetic units
- Multi-level look-ahead carry generation for long word lengths

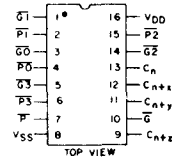
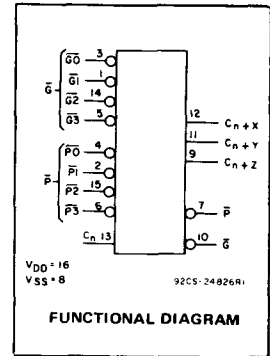

### TERMINAL ASSIGNMENT

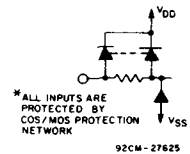
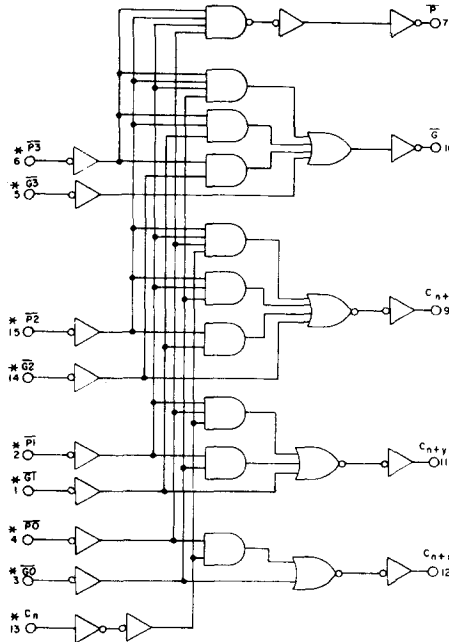

Fig. 1 - CD40182B logic diagram.

### CD40182B Logic Equations:

$$C_{n+x} = G0 + P0 \cdot C_n$$

$$C_{n+y} = G1 + P1 \cdot G0 + P1 \cdot P0 \cdot C_n$$

$$C_{n+z} = G2 + P2 \cdot G1 + P2 \cdot P1 \cdot G0 + P2 \cdot P1 \cdot P0 \cdot C_n$$

$$\overline{G} = \overline{G3} + P3 \cdot \overline{G2} + P3 \cdot P2 \cdot \overline{G1} + P3 \cdot P2 \cdot P1 \cdot \overline{G0}$$

$$\overline{P} = \overline{P3} \cdot \overline{P2} \cdot \overline{P1} \cdot \overline{P0}$$

# CD40182B Types

## RECOMMENDED OPERATING CONDITIONS

For maximum reliability, nominal operating conditions should be selected so that operation is always within the following ranges:

CHARACTERISTIC	LIMITS		UNITS
	MIN.	MAX.	
Supply Voltage Range (For $T_A$ = Full Package-Temperature Range)	3	18	V

## MAXIMUM RATINGS, Absolute-Maximum Values:

DC SUPPLY-VOLTAGE RANGE, ( $V_{DD}$ )	(Voltages referenced to $V_{SS}$ Terminal)	-0.5 to +20 V
INPUT VOLTAGE RANGE, ALL INPUTS		-0.5 to $V_{DD} + 0.5$ V
DC INPUT CURRENT, ANY ONE INPUT		$\pm 10$ mA
POWER DISSIPATION PER PACKAGE ( $P_D$ ):		
For $T_A = -40$ to $+60^\circ\text{C}$ (PACKAGE TYPE E)		500 mW
For $T_A = +60$ to $+85^\circ\text{C}$ (PACKAGE TYPE E)		Derate Linearly at 12 mW/ $^\circ\text{C}$ to 200 mW
For $T_A = -55$ to $+100^\circ\text{C}$ (PACKAGE TYPES D, F, K)		500 mW
For $T_A = +100$ to $+125^\circ\text{C}$ (PACKAGE TYPES D, F, K)		Derate Linearly at 12 mW/ $^\circ\text{C}$ to 200 mW
DEVICE DISSIPATION PER OUTPUT TRANSISTOR:		
For $T_A = \text{FULL PACKAGE-TEMPERATURE RANGE}$ (All Package Types)		100 mW
OPERATING-TEMPERATURE RANGE ( $T_A$ ):		
PACKAGE TYPES D, F, K, H		$-55$ to $+125^\circ\text{C}$
PACKAGE TYPE E		$-40$ to $+85^\circ\text{C}$
STORAGE TEMPERATURE RANGE ( $T_{stg}$ )		$-65$ to $+150^\circ\text{C}$
LEAD TEMPERATURE (DURING SOLDERING):		
At distance $1/16 \pm 1/32$ inch ( $1.59 \pm 0.79$ mm) from case for 10 s max.		$+265^\circ\text{C}$

## STATIC ELECTRICAL CHARACTERISTICS

CHARACTERISTIC	CONDITIONS			LIMITS AT INDICATED TEMPERATURES ( $^\circ\text{C}$ )							UNITS
				Values at $-55$ , $+25$ , $+125$ Apply to D, F, K, H Packages Values at $-40$ , $+25$ , $+85$ Apply to E Package							
	$V_O$ (V)	$V_{IN}$ (V)	$V_{DD}$ (V)	$-55$	$-40$	$+85$	$+125$	$+25$			
Quiescent Device Current, $I_{DD}$ Max.	-	0.5	5	5	5	150	150	-	0.04	5	$\mu\text{A}$
	-	0.10	10	10	10	300	300	-	0.04	10	
	-	0.15	15	20	20	600	600	-	0.04	20	
	-	0.20	20	100	100	3000	3000	-	0.08	100	
Output Low (Sink) Current $I_{OL}$ Min.	0.4	0.5	5	0.64	0.61	0.42	0.36	0.51	1	-	mA
	0.5	0.10	10	1.6	1.5	1.1	0.9	1.3	2.6	-	
	1.5	0.15	15	4.2	4	2.8	2.4	3.4	6.8	-	
Output High (Source) Current, $I_{OH}$ Min.	4.6	0.5	5	-0.64	-0.61	-0.42	-0.36	-0.51	-1	-	mA
	2.5	0.5	5	-2	-1.8	-1.3	-1.15	-1.6	-3.2	-	
	9.5	0.10	10	-1.6	-1.5	-1.1	-0.9	-1.3	-2.6	-	
	13.5	0.15	15	-4.2	-4	-2.8	-2.4	-3.4	-6.8	-	
Output Voltage: Low-Level, $V_{OL}$ Max.	-	0.5	5	0.05				-	0	0.05	V
	-	0.10	10	0.05				-	0	0.05	
	-	0.15	15	0.05				-	0	0.05	
Output Voltage: High-Level, $V_{OH}$ Min.	-	0.5	5	4.95				4.95	5	-	V
	-	0.10	10	9.95				9.95	10	-	
	-	0.15	15	14.95				14.95	15	-	
Input Low Voltage, $V_{IL}$ Max.	0.5, 4.5	-	5	1.5				-	-	1.5	V
	1, 9	-	10	3				-	-	3	
	1.5, 13.5	-	15	4				-	-	4	
Input High Voltage, $V_{IH}$ Min.	0.5, 4.5	-	5	3.5				3.5	-	-	V
	1, 9	-	10	7				7	-	-	
	1.5, 13.5	-	15	11				11	-	-	
Input Current $I_{IN}$ Max.	-	0.18	18	$\pm 0.1$	$\pm 0.1$	$\pm 1$	$\pm 1$	-	$\pm 10^{-5}$	$\pm 0.1$	$\mu\text{A}$

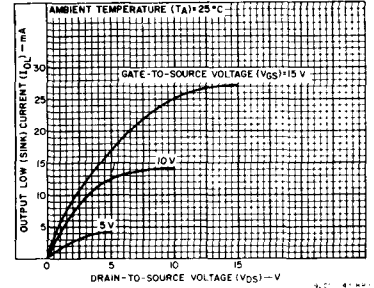

Fig. 2 - Typical output low (sink) current characteristics.

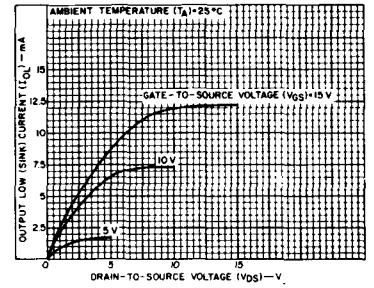

Fig. 3 - Minimum output low (sink) current characteristics.

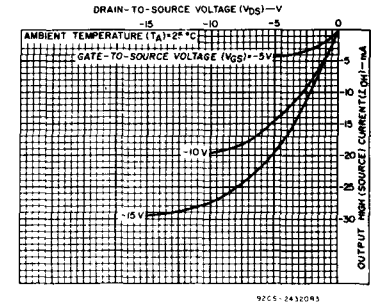

Fig. 4 - Typical output high (source) current characteristics.

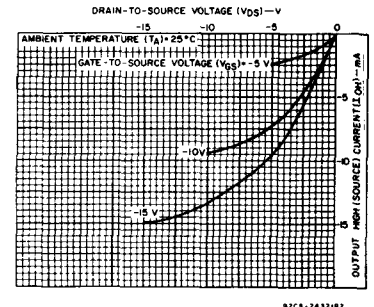

Fig. 5 - Minimum output high (source) current characteristics.

# CD40182B Types

## DYNAMIC ELECTRICAL CHARACTERISTICS

At  $T_A = 25^\circ\text{C}$ ; Input  $t_r, t_f = 20\text{ ns}$ ,  $C_L = 50\text{ pF}$ ,  $R_L = 200\text{ k}\Omega$

CHARACTERISTIC	V <sub>DD</sub> (V)	LIMITS		UNITS
		Typ.	Max.	
Propagation Delay Time: $t_{PHL}$ , $t_{PLH}$ P, G In to P, G Out and Carry Outs	5 10 15	200 100 75	400 200 150	ns
$C_n$ to Carry Outs	5 10 15	240 120 90	480 240 180	ns
Transition Time: $t_{THL}$ , $t_{TLH}$	5 10 15	100 50 40	200 100 80	ns
Input Capacitance $C_{iN}$ (Any Input)	—	5	7.5	pF

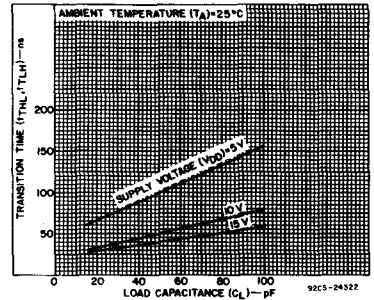

Fig. 6 - Typical transition time as a function of load capacitance.

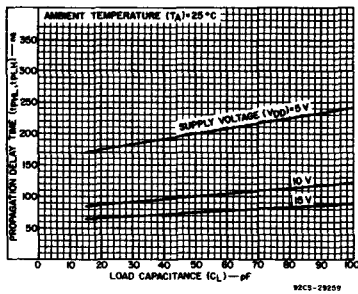

Fig. 7 - Typical propagation delay time as a function of load capacitance (P, G In to P, G Out and Carry-Outs).

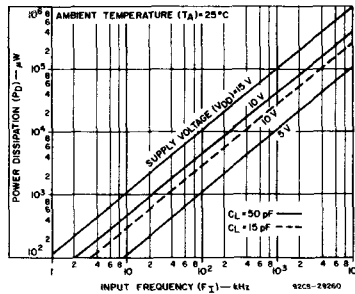

Fig. 8 - Typical power dissipation as a function of input frequency.

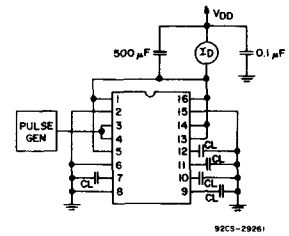

Fig. 9 - Power dissipation test circuit.

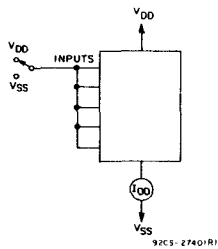

Fig. 10 - Quiescent device current test circuit.

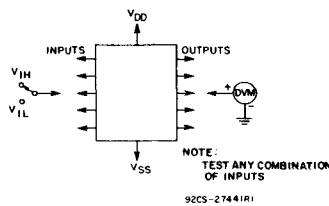

Fig. 11 - Input voltage test circuit.

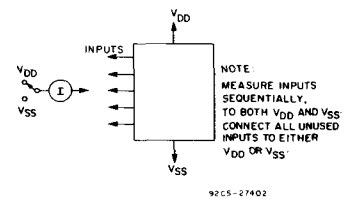

Fig. 12 - Input current test circuit.

## Applications

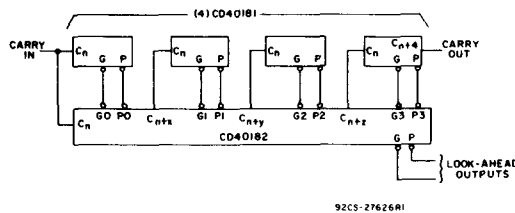

Fig. 13 - 16-Bit two-level look-ahead ALU.



# CD40182B Types

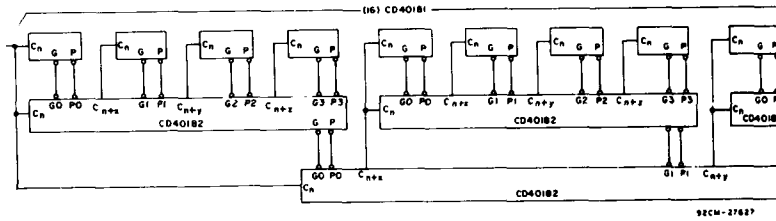

Fig. 14 – 64-Bit full carry look-ahead ALU in 3 levels.

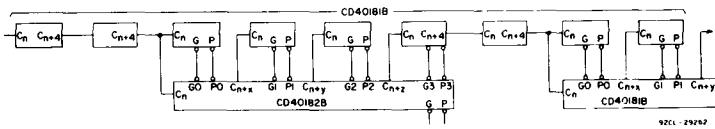
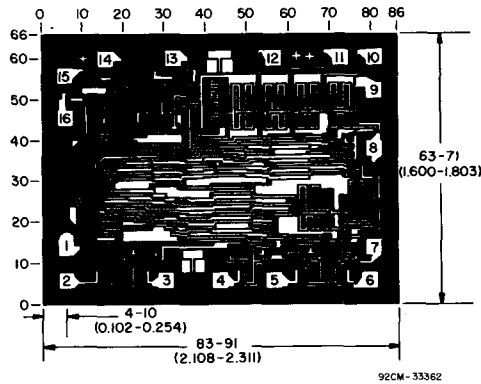

Fig. 15 – Combined two-level look-ahead and ripple-carry ALU.

## DIMENSIONS AND PAD LAYOUT FOR CD40182BH



Dimensions in parentheses are in millimeters and are derived from the basic inch dimensions as indicated. Grid graduations are in mils ( $10^{-3}$  inch).

The photographs and dimensions of each CMOS chip represent a chip when it is part of the wafer. When the wafer is separated into individual chips, the angle of cleavage may vary with respect to the chip face for different chips. The actual dimensions of the isolated chip, therefore, may differ slightly from the nominal dimensions shown. The user should consider a tolerance of  $-3$  mils to  $+16$  mils applicable to the nominal dimensions shown.

# CD40192B, CD40193B Types

## CMOS Presettable Up/Down Counters (Dual Clock With Reset)

High-Voltage Types (20-Volt Rating)

CD40192 – BCD Type

CD40193 – Binary Type

The RCA-CD40192B Presettable BCD Up/Down Counter and the CD40193B Presettable Binary Up/Down Counter each consist of 4 synchronously clocked, gated "D" type flip-flops connected as a counter. The inputs consist of 4 individual jam lines, a PRESET ENABLE control, individual CLOCK UP and CLOCK DOWN signals and a master RESET. Four buffered Q signal outputs as well as CARRY and BORROW outputs for multiple-stage counting schemes are provided.

The counter is cleared so that all outputs are in a low state by a high on the RESET line. A RESET is accomplished asynchronously with the clock. Each output is individually programmable asynchronously with the clock to the level on the corresponding jam input when the PRESET ENABLE control is low.

The counter counts up one count on the positive clock edge of the CLOCK UP signal provided the CLOCK DOWN line is high. The counter counts down one count on the positive clock edge of the CLOCK DOWN signal provided the CLOCK UP line is high.

The CARRY and BORROW signals are high when the counter is counting up or down. The CARRY signal goes low one-half clock cycle after the counter reaches its maximum count in the count-up mode. The BORROW signal goes low one-half clock cycle after the counter reaches its minimum count in the count-down mode. Cascading of multiple packages is easily accomplished without the need for additional external circuitry by tying the BORROW and CARRY outputs to the CLOCK DOWN and CLOCK UP inputs, respectively, of the succeeding counter package.

The CD40192B and CD40193B types are supplied in 16-lead hermetic dual-in-line ceramic packages (D and F suffixes), 16-lead dual-in-line plastic packages (E suffix), 16-lead ceramic flat packages (K suffix), and in chip form (H suffix).

### Features:

- Individual clock lines for counting up or counting down
- Synchronous high-speed carry and borrow propagation delays for cascading
- Asynchronous reset and preset capability
- Medium-speed operation— $f_{CL} = 8 \text{ MHz (typ.) @ 10 V}$
- 5-V, 10-V, and 15-V parametric ratings
- Standardized, symmetrical output characteristics
- 100% tested for quiescent current at 20 V
- Maximum input current of 1  $\mu\text{A}$  at 18 V over full package temperature range; 100 nA at 18 V and 25°C
- Noise margin over full package temperature range:
  - 1 V at  $V_{DD} = 5 \text{ V}$     2 V at  $V_{DD} = 10 \text{ V}$
  - 2.5 V at  $V_{DD} = 15 \text{ V}$
- Meets all requirements of JEDEC Tentative Standard No. 13A, "Standard Specifications for Description of 'B' Series CMOS Devices"

### Applications:

- Up/down difference counting
- Multistage ripple counting
- Synchronous frequency dividers
- A/D and D/A conversion
- Programmable binary or BCD counting

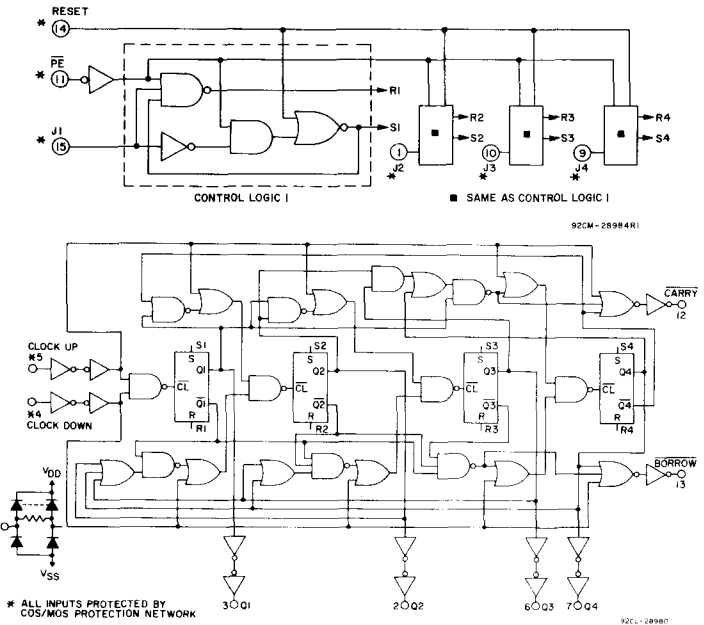
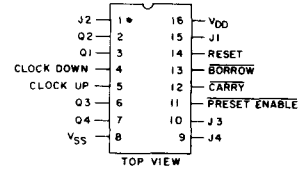
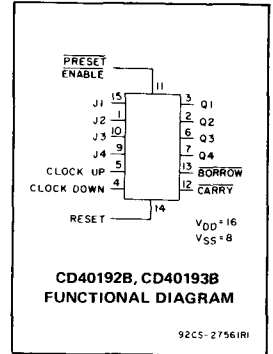

Fig. 1 — CD40192B logic diagram (BCD).

# CD40192B, CD40193B Types

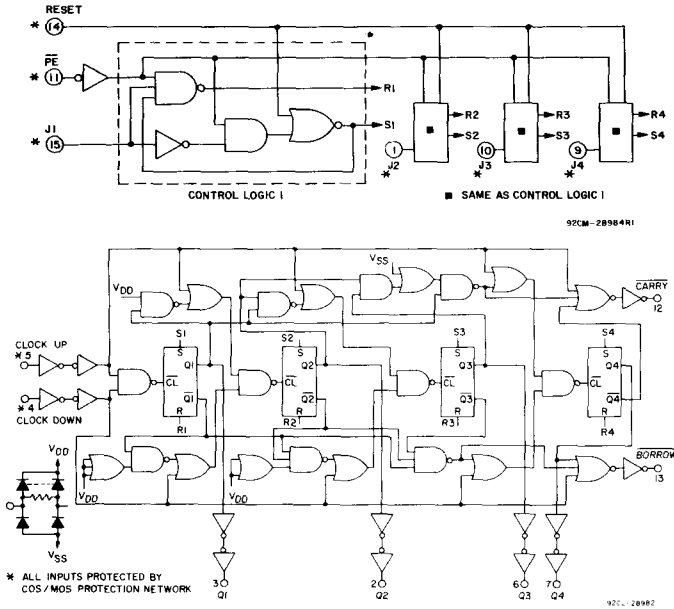

Fig. 2 - CD40193B logic diagram (binary).

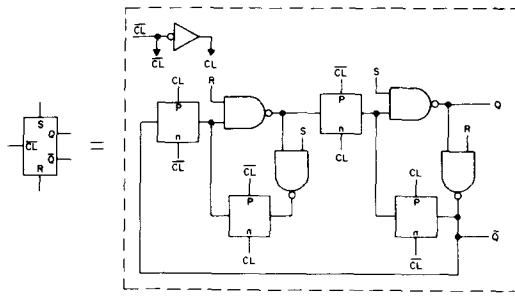

Fig. 4 - Internal logic of Flip-flop.

## TRUTH TABLE

CLOCK UP	CLOCK DOWN	PRESET ENABLE	RESET	ACTION
	1	1	0	COUNT UP
	1	1	0	NO COUNT
1		1	0	COUNT DOWN
1		1	0	NO COUNT
X	X	0	0	PRESET
X	X	X	1	RESET

1 = HIGH LEVEL

0 = LOW LEVEL

X = DON'T CARE

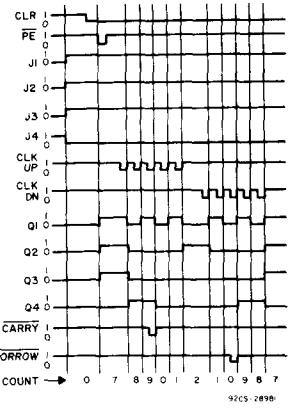

Fig. 3 - CD40192B timing diagram.

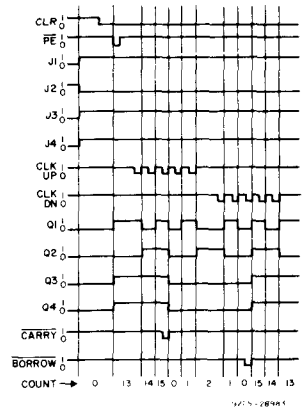

Fig. 5 - CD40193B timing diagram.

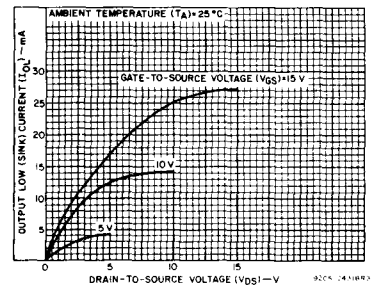

Fig. 6 - Typical output low (sink) current characteristics.

# CD40192B, CD40193B Types

## MAXIMUM RATINGS, Absolute-Maximum Values:

DC SUPPLY-VOLTAGE RANGE, ( $V_{DD}$ )		
(Voltages referenced to $V_{SS}$ Terminal)	.....	-0.5 to +20 V
INPUT VOLTAGE RANGE, ALL INPUTS	.....	-0.5 to $V_{DD} + 0.5$ V
DC INPUT CURRENT, ANY ONE INPUT	.....	$\pm 10$ mA
POWER DISSIPATION PER PACKAGE ( $P_D$ ):		
For $T_A = -40$ to $+60^\circ\text{C}$ (PACKAGE TYPE E)	.....	500 mW
For $T_A = +60$ to $+85^\circ\text{C}$ (PACKAGE TYPE E)	.....	Derate Linearly at 12 mW/ $^\circ\text{C}$ to 200 mW
For $T_A = -55$ to $+100^\circ\text{C}$ (PACKAGE TYPES D, F, K)	.....	500 mW
For $T_A = +100$ to $+125^\circ\text{C}$ (PACKAGE TYPES D, F, K)	.....	Derate Linearly at 12 mW/ $^\circ\text{C}$ to 200 mW
DEVICE DISSIPATION PER OUTPUT TRANSISTOR:		
For $T_A = \text{FULL PACKAGE-TEMPERATURE RANGE (All Package Types)}$	.....	100 mW
OPERATING-TEMPERATURE RANGE ( $T_A$ ):		
PACKAGE TYPES D, F, K, H	.....	$-55$ to $+125^\circ\text{C}$
PACKAGE TYPE E	.....	$-40$ to $+85^\circ\text{C}$
STORAGE TEMPERATURE RANGE ( $T_{stg}$ )	.....	$-65$ to $+150^\circ\text{C}$
LEAD TEMPERATURE (DURING SOLDERING):		
At distance $1/16 \pm 1/32$ inch ( $1.59 \pm 0.79$ mm) from case for 10 s max.	.....	$+265^\circ\text{C}$

## RECOMMENDED OPERATING CONDITIONS at $T_A = 25^\circ\text{C}$ (unless otherwise specified)

For maximum reliability, nominal operating conditions should be selected so that operation is always within the following ranges.

CHARACTERISTIC	$V_{DD}$ (V)	LIMITS		UNITS
		Min.	Max.	
Supply Voltage Range (For $T_A = \text{Full Temp. Range}$ )	—	3	18	V
Removal Time: RESET or $\overline{PE}$	5	80	—	ns
	10	40	—	
	15	30	—	
Pulse Width: RESET	5	480	—	ns
	10	300	—	
	15	260	—	
$\overline{PE}$	5	240	—	ns
	10	170	—	
	15	140	—	
CLOCK	5	180	—	ns
	10	90	—	
	15	60	—	
Clock Input Frequency	5	2	4	MHz
	10	DC	5.5	
	15	—	—	
Clock Rise & Fall Time	5	—	15	$\mu\text{s}$
	10	—	15	
	15	—	5	

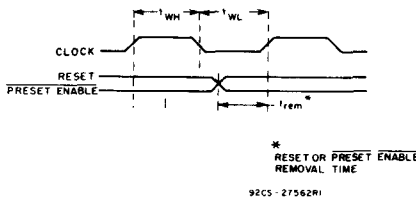

Fig. 10 — Timing diagram defining  $t_{rem}$

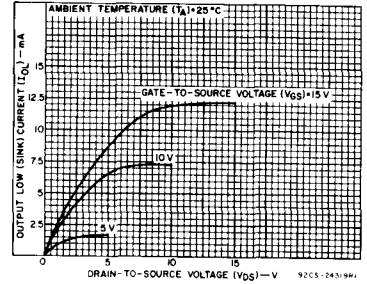

Fig. 7 — Minimum output low (sink) current characteristics.

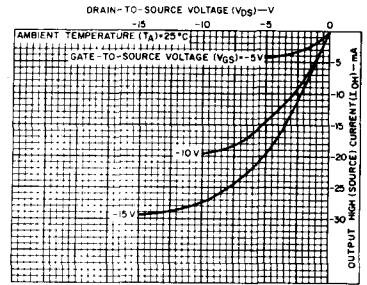

Fig. 8 — Typical output high (source) current characteristics.

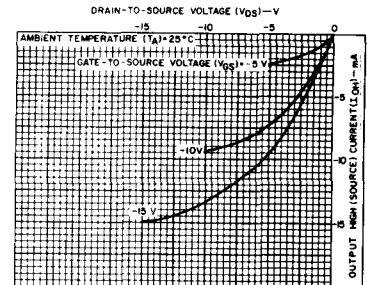

Fig. 9 — Minimum output high (source) current characteristics.

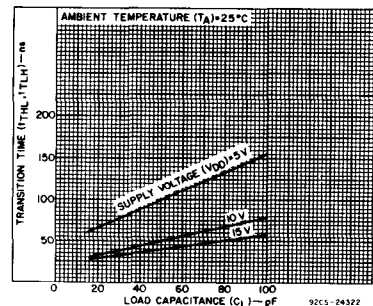

Fig. 11 — Typical transition time as a function of load capacitance.

# CD40192B, CD40193B Types

## STATIC ELECTRICAL CHARACTERISTICS

CHARACTERISTIC	CONDITIONS			LIMITS AT INDICATED TEMPERATURES (°C)							UNITS
				Values at -55, +25, +125 Apply to D, F, K, H Packages Values at -40, +25, +85 Apply to E Package							
	V <sub>O</sub> (V)	V <sub>IN</sub> (V)	V <sub>DD</sub> (V)	+25							
-55				-40	+85	+125	Min.	Typ.	Max.		
Quiescent Device Current, I <sub>DD</sub> Max.	-	0,5	5	5	5	150	150	-	0,04	5	μA
	-	0,10	10	10	10	300	300	-	0,04	10	
	-	0,15	15	20	20	600	600	-	0,04	20	
	-	0,20	20	100	100	3000	3000	-	0,08	100	
Output Low (Sink) Current I <sub>OL</sub> Min.	0,4	0,5	5	0,64	0,61	0,42	0,36	0,51	1	-	mA
	0,5	0,10	10	1,6	1,5	1,1	0,9	1,3	2,6	-	
	1,5	0,15	15	4,2	4	2,8	2,4	3,4	6,8	-	
Output High (Source) Current, I <sub>OH</sub> Min.	4,6	0,5	5	-0,64	-0,61	-0,42	-0,36	-0,51	-1	-	mA
	2,5	0,5	5	-2	-1,8	-1,3	-1,15	-1,6	-3,2	-	
	9,5	0,10	10	-1,6	-1,5	-1,1	-0,9	-1,3	-2,6	-	
	13,5	0,15	15	-4,2	-4	-2,8	-2,4	-3,4	-6,8	-	
Output Voltage: Low-Level, V <sub>OL</sub> Max.	-	0,5	5	0,05			-	0	0,05	-	V
	-	0,10	10	0,05			-	0	0,05	-	
	-	0,15	15	0,05			-	0	0,05	-	
Output Voltage: High-Level, V <sub>OH</sub> Min.	-	0,5	5	4,95			4,95	5	-	-	V
	-	0,10	10	9,95			9,95	10	-	-	
	-	0,15	15	14,95			14,95	15	-	-	
Input Low Voltage, V <sub>IL</sub> Max.	0,5, 4,5	-	5	1,5			-	-	1,5	-	V
	1,9	-	10	3			-	-	3	-	
	1,5, 13,5	-	15	4			-	-	4	-	
Input High Voltage, V <sub>IH</sub> Min.	0,5, 4,5	-	5	3,5			3,5	-	-	-	V
	1,9	-	10	7			7	-	-	-	
	1,5, 13,5	-	15	11			11	-	-	-	
Input Current I <sub>IN</sub> Max.	-	0,18	18	±0,1	±0,1	±1	±1	-	±10 <sup>-5</sup>	±0,1	μA

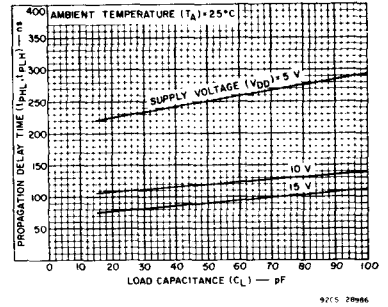

Fig. 12 - Typical propagation delay time as a function of load capacitance.

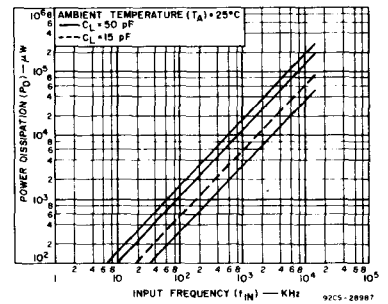
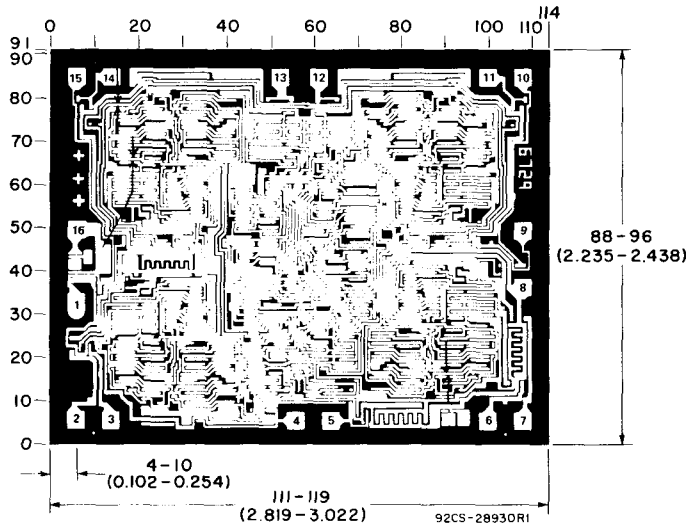

Fig. 13 - Dynamic power dissipation.



Dimensions and pad layout for the CD40192BH (dimensions and pad layout for the CD40193BH are identical).

Dimensions in parentheses are in millimeters and are derived from the basic inch dimensions as indicated. Grid graduations are in mils (10<sup>-3</sup> inch).

The photographs and dimensions of each CMOS chip represent a chip when it is part of the wafer. When the wafer is separated into individual chips, the angle of cleavage may vary with respect to the chip face for different chips. The actual dimensions of the isolated chip, therefore, may differ slightly from the nominal dimensions shown. The user should consider a tolerance of -3 mils to +16 mils applicable to the nominal dimensions shown.

# CD40192B, CD40193B Types

DYNAMIC ELECTRICAL CHARACTERISTICS at  $T_A = 25^\circ\text{C}$

Input  $t_r, t_f = 20\text{ ns}$ ,  $C_L = 50\text{ pF}$ ,  $R_L = 200\text{ k}\Omega$

CHARACTERISTIC	$V_{DD}$ (V)	LIMITS			UNITS
		Min.	Typ.	Max.	
Propagation Delay Time $t_{PHL}, t_{PLH}$ : CLOCK UP or CLOCK DOWN to Q, RESET to Q	5	-	250	500	ns
	10	-	120	240	
	15	-	90	180	
$\overline{PE}$ to Q	5	-	200	400	ns
	10	-	100	200	
	15	-	70	140	
CLOCK UP to $\overline{CARRY}$ , CLOCK DOWN to $\overline{BORROW}$	5	-	160	320	ns
	10	-	80	160	
	15	-	60	120	
$\overline{RESET}$ or $\overline{PE}$ to $\overline{BORROW}$ or $\overline{CARRY}$	5	-	300	600	ns
	10	-	150	300	
	15	-	110	220	
Transition Time, $t_{THL}, t_{TLH}$	5	-	100	200	ns
	10	-	50	100	
	15	-	40	80	
Min. Removal Time, $t_{rem}$ * RESET or $\overline{PE}$	5	-	40	80	ns
	10	-	20	40	
	15	-	15	30	
Min. Pulse Width, $t_w$ RESET	5	-	240	480	ns
	10	-	150	300	
	15	-	130	260	
$\overline{PE}$	5	-	120	240	ns
	10	-	85	170	
	15	-	70	140	
CLOCK	5	-	90	180	ns
	10	-	45	90	
	15	-	30	60	
Max. Clock Input Frequency, $f_{CL}$	5	2	4	-	MHz
	10	4	8	-	
	15	5.5	11	-	
Clock Rise & Fall Time, $t_r, t_f$	5	-	-	15	$\mu\text{s}$
	10	-	-	15	
	15	-	-	5	
Input Capacitance, $C_{IN}$ :					
	RESET	-	-	10	15
All Other Inputs	-	-	5	7.5	pF

\* The time required for RESET or PRESET ENABLE control to be removed before clocking (see timing diagram, Fig. 10).

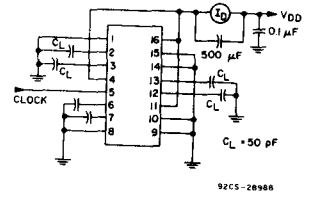

Fig. 14 - Dynamic power dissipation test circuit.

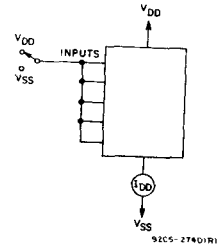

Fig. 15 - Quiescent device current test circuit.

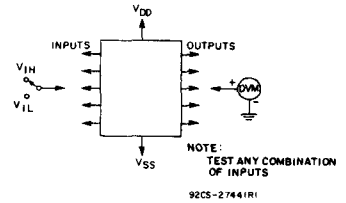

Fig. 16 - Input voltage test circuit.

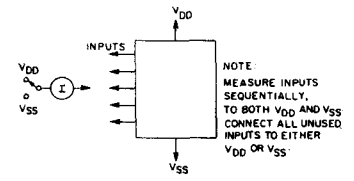

Fig. 17 - Input current test circuit.

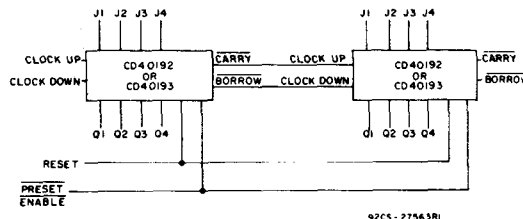

Fig. 18 - Cascaded counter packages.

# CMOS 4 x 4 Multiport Register

High-Voltage Types (20-Volt Rating)

The RCA-CD40208B is a 4 x 4 multiport register containing four 4-bit registers, write address decoder, two separate read address decoders, and two 3-state output buses.

When the ENABLE input is low, the corresponding output bus is switched, independently of the clock, to a high-impedance state. The high-impedance third state provides the outputs with the capability of being connected to the bus lines in a bus-organized system without the need for interface or pull-up components.

When the WRITE ENABLE input is high, all data input lines are latched on the positive transition of the CLOCK and the data is entered into the word selected by the write address lines. When WRITE ENABLE is low, the CLOCK is inhibited and no new data is entered. In either case, the contents of any word may be accessed via the read address lines independent of the state of the CLOCK input.

The CD40208B types are supplied in hermetic 24-lead dual-in-line ceramic packages (D and F suffixes), 24-lead dual-in-line plastic packages (E suffix), 24-lead ceramic flat packages (K suffix), and in chip form (H suffix).

### Features:

- Four 4-bit registers
- One input and two output buses
- Unlimited expansion in bit and word directions
- Data lines have latched inputs
- 3-state outputs
- Separate control of each bus, allowing simultaneous independent reading of any of four registers on Bus A and Bus B and independent writing into any of the four registers
- Standardized, symmetrical output characteristics
- 100% tested for quiescent current at 20 V
- Maximum input current of 1  $\mu$ A at 18 V over full package-temperature range; 100 nA at 18 V and 25°C
- Noise margin (over full package-temperature range):
  - 1 V at  $V_{DD} = 5$  V
  - 2 V at  $V_{DD} = 10$  V
  - 2.5 V at  $V_{DD} = 15$  V
- 5-V, 10-V, and 15-V parametric ratings
- Meets all requirements of JEDEC Tentative Standard No. 13A, "Standard Specifications for Description of 'B' Series CMOS Devices"

### Applications:

- Scratch-pad memories
- Arithmetic units
- Data storage

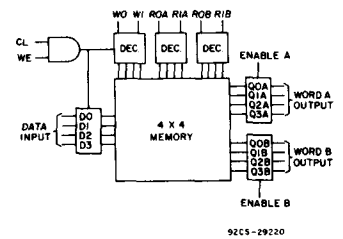
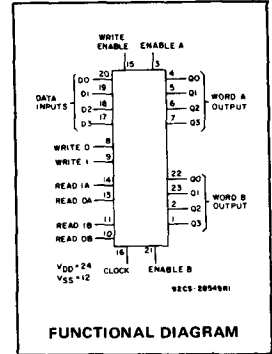
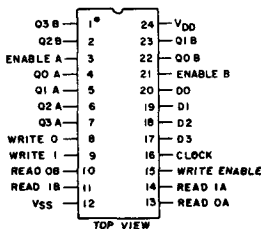

Fig. 1 - Block diagram.



TERMINAL ASSIGNMENT

TRUTH TABLE												
CLOCK	WRITE ENABLE	WRITE 1	WRITE 0	READ 1A	READ 0A	READ 1B	READ 0B	ENABLE A	ENABLE B	$D_n$	$Q_{nA}$	$Q_{nB}$
—	1	S1	S2	S1	S2	S1	S2	1	1	1	1	1
—	1	S1	S2	S1	S2	S1	S2	1	1	0	0	0
X	X	X	X	X	X	X	X	0	0	X	Z	Z
—	1	0	0	0	1	1	0	1	1	$D_n$ to word 0	Word 1 out	Word 2 out
—	0	0	0	0	1	1	0	1	1	Word 0 not altered	Word 1 out	Word 2 out
X	X	X	X	1	0	0	1	1	1	X	Word 2 out	Word 1 out
—	X	X	X	X	X	X	X	1	1	X	NC	NC

1 - HIGH LEVEL; 0 - LOW LEVEL; X - DON'T CARE; Z - HIGH IMPEDANCE  
 S1 and S2 refer to input states of either 1 or 0

### MAXIMUM RATINGS, Absolute-Maximum Values:

- DC SUPPLY-VOLTAGE RANGE, ( $V_{DD}$ ) (Voltages referenced to  $V_{SS}$  Terminal) ..... -0.5 to +20 V
- INPUT VOLTAGE RANGE, ALL INPUTS ..... -0.5 to  $V_{DD} + 0.5$  V
- DC INPUT CURRENT, ANY ONE INPUT .....  $\pm 10$  mA
- POWER DISSIPATION PER PACKAGE ( $P_D$ ):
  - For  $T_A = -40$  to  $+60^\circ\text{C}$  (PACKAGE TYPE E) ..... 500 mW
  - For  $T_A = +60$  to  $+85^\circ\text{C}$  (PACKAGE TYPE E) ..... Derate Linearly at 12 mW/ $^\circ\text{C}$  to 200 mW
  - For  $T_A = -55$  to  $+100^\circ\text{C}$  (PACKAGE TYPES D, F, K) ..... 500 mW
  - For  $T_A = +100$  to  $+125^\circ\text{C}$  (PACKAGE TYPES D, F, K) ..... Derate Linearly at 12 mW/ $^\circ\text{C}$  to 200 mW
- DEVICE DISSIPATION PER OUTPUT TRANSISTOR:
  - For  $T_A = \text{FULL PACKAGE-TEMPERATURE RANGE (All Package Types)}$  ..... 100 mW
- OPERATING-TEMPERATURE RANGE ( $T_A$ ):
  - PACKAGE TYPES D, F, K, H ..... -55 to  $+125^\circ\text{C}$
  - PACKAGE TYPE E ..... -40 to  $+85^\circ\text{C}$
- STORAGE TEMPERATURE RANGE ( $T_{stg}$ ) ..... -65 to  $+150^\circ\text{C}$
- LEAD TEMPERATURE (DURING SOLDERING):
  - At distance  $1/16 \pm 1/32$  inch (1.59  $\pm$  0.79 mm) from case for 10 s max. ....  $+265^\circ\text{C}$

# CD40208B Types

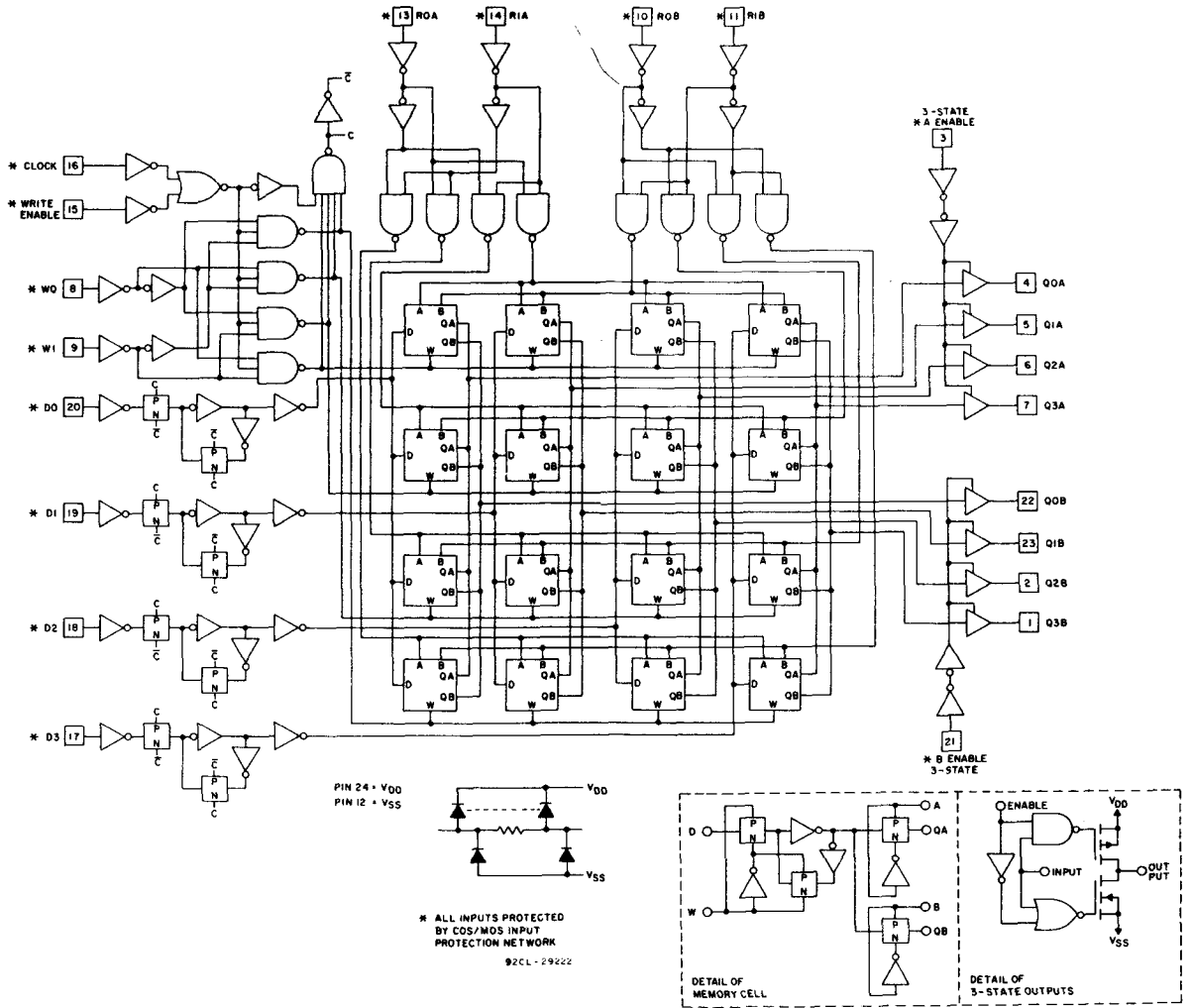

Fig. 2 - Logic diagram.

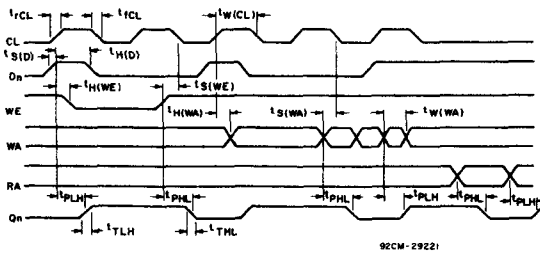

Fig. 3 - Timing diagram.



# CD40208B Types

**RECOMMENDED OPERATING CONDITIONS** at  $T_A = 25^\circ\text{C}$ . *Except as Noted.*  
 For maximum reliability, nominal operating conditions should be selected so that operation is always within the following ranges:

CHARACTERISTIC	VDD (V)	LIMITS		UNITS
		MIN.	MAX.	
Supply Voltage Range (For $T_A =$ Full Package Temperature Range)	—	3	18	V
Set-Up Time: Data to Clock, $t_{S(D)}$	5 10 15	0 0 0	— — —	ns
Write Enable to Clock, $t_{S(WE)}$	5 10 15	250 100 70	— — —	ns
Write Address to Clock, $t_{S(WA)}$	5 10 15	250 100 70	— — —	ns
Hold Time: Data to Clock, $t_{H(D)}$	5 10 15	220 100 80	— — —	ns
Write Enable to Clock, $t_{H(WE)}$	5 10 15	270 130 80	— — —	ns
Write Address to Clock, $t_{H(WA)}$	5 10 15	330 140 90	— — —	ns
Clock Input Frequency, $f_{CL}$	5 10 15	— — —	1.5 3.5 4.5	MHz
Clock Pulse Width, CL or WE $t_W$	5 10 15	350 130 90	— — —	ns
Clock Rise or Fall Time, $t_{rCL}$ or $t_{fCL}$	5 10 15	— — —	15 5 5	$\mu\text{s}$

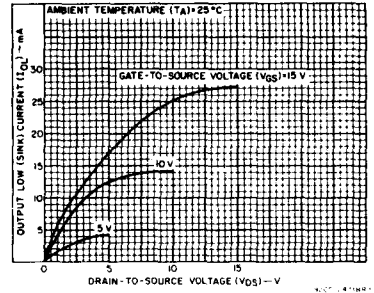

Fig. 4 — Typical output low (sink) current characteristics.

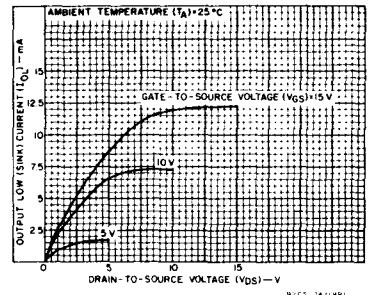

Fig. 5 — Minimum output low (sink) current characteristics.

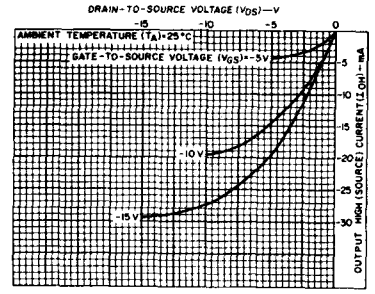

Fig. 6 — Typical output high (source) current characteristics.

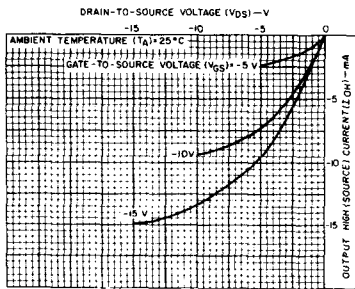

Fig. 7 — Minimum output high (source) current characteristics.

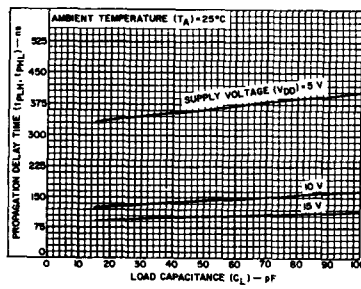

Fig. 8 — Typical propagation delay time as a function of load capacitance (CL or WE to Q).

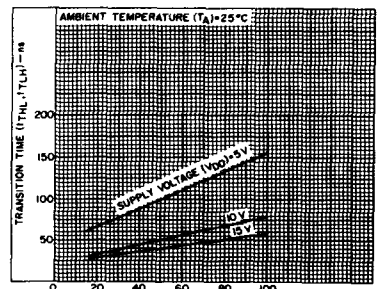

Fig. 9 — Typical transition time as a function of load capacitance.

# CD40208B Types

## STATIC ELECTRICAL CHARACTERISTICS

CHARACTERISTIC	CONDITIONS			LIMITS AT INDICATED TEMPERATURES (°C)							UNITS
	V <sub>O</sub> (V)	V <sub>IN</sub> (V)	V <sub>DD</sub> (V)	Values at -55, +25, +125 Apply to D,K,F,H Packages				Values at -40, +25, +85 Apply to E Package			
				-55	-40	+85	+125	+25			
								Min.	Typ.	Max.	
Quiescent Device Current, I <sub>DD</sub> Max.	-	0,5	5	5	5	150	150	-	0.04	5	μA
	-	0,10	10	10	10	300	300	-	0.04	10	
	-	0,15	15	20	20	600	600	-	0.04	20	
	-	0,20	20	100	100	3000	3000	-	0.08	100	
Output Low (Sink) Current I <sub>OL</sub> Min.	0.4	0,5	5	0.64	0.61	0.42	0.36	0.51	1	-	mA
	0.5	0,10	10	1.6	1.5	1.1	0.9	1.3	2.6	-	
	1.5	0,15	15	4.2	4	2.8	2.4	3.4	6.8	-	
	9.5	0,10	10	-1.6	-1.5	-1.1	-0.9	-1.3	-2.6	-	
Output High (Source) Current, I <sub>OH</sub> Min.	4.6	0,5	5	-0.64	-0.61	-0.42	-0.36	-0.51	-1	-	mA
	2.5	0,5	5	-2	-1.8	-1.3	-1.15	-1.6	-3.2	-	
	9.5	0,10	10	-1.6	-1.5	-1.1	-0.9	-1.3	-2.6	-	
	13.5	0,15	15	-4.2	-4	-2.8	-2.4	-3.4	-6.8	-	
Output Voltage: Low-Level, V <sub>OL</sub> Max.	-	0,5	5	0.05				-	0	0.05	V
	-	0,10	10	0.05				-	0	0.05	
	-	0,15	15	0.05				-	0	0.05	
Output Voltage: High-Level, V <sub>OH</sub> Min.	-	0,5	5	4.95				4.95	5	-	V
	-	0,10	10	9.95				9.95	10	-	
	-	0,15	15	14.95				14.95	15	-	
Input Low Voltage, V <sub>IL</sub> Max.	0.5, 4.5	-	5	1.5				-	-	1.5	V
	1, 9	-	10	3				-	-	3	
	15, 13.5	-	15	4				-	-	4	
Input High Voltage, V <sub>IH</sub> Min.	0.5, 4.5	-	5	3.5				3.5	-	-	V
	1, 9	-	10	7				7	-	-	
	1.5, 13.5	-	15	11				11	-	-	
Input Current I <sub>IN</sub> Max.	-	0,18	18	±0.1	±0.1	±1	±1	-	±10 <sup>-5</sup>	±0.1	μA
3-State Output Leakage Current I <sub>OUT</sub> Max.	0,18	0,18	18	±0.4	±0.4	±12	±12	-	±10 <sup>-4</sup>	±0.4	μA

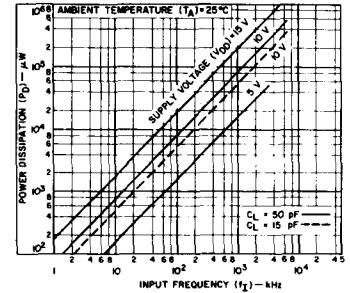

Fig. 10 - Typical power dissipation as a function of input frequency.

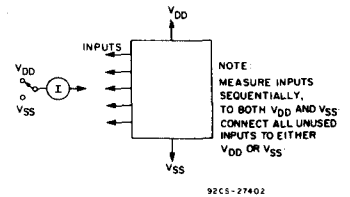

Fig. 11 - Input leakage current test circuit.

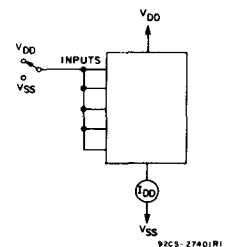
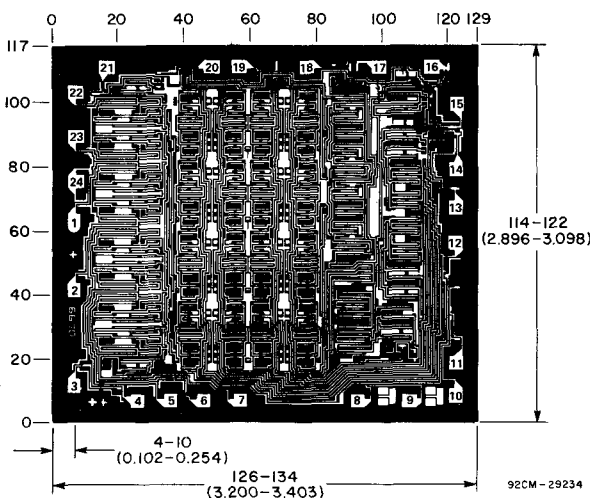

Fig. 12 - Quiescent-device-current test circuit.



### Dimensions and Pad Layout for CD40208BH

Dimensions in parentheses are in millimeters and are derived from the basic inch dimensions as indicated. Grid graduations are in mils (10<sup>-3</sup> inch).

The photographs and dimensions of each CMOS chip represent a chip when it is part of the wafer. When the wafer is separated into individual chips, the angle of cleavage may vary with respect to the chip face for different chips. The actual dimensions of the isolated chip, therefore, may differ slightly from the nominal dimensions shown. The user should consider a tolerance of -3 mils to +16 mils applicable to the nominal dimensions shown.

# CD40208B Types

DYNAMIC ELECTRICAL CHARACTERISTICS at  $T_A = 25^\circ\text{C}$ ; Input  $t_r, t_f = 20 \text{ ns}$ ,  $C_L = 50 \text{ pF}$ ,  $R_L = 200 \text{ k}\Omega$

CHARACTERISTIC	V <sub>DD</sub> (V)	LIMITS			UNITS
		Min.	Typ.	Max.	
Propagation Delay Time: $t_{\text{PHL}}, t_{\text{PLH}}$ Clock or Write Enable to Q Read or Write Address to Q	5	—	360	720	ns
	10	—	140	280	
	15	—	100	200	
3-State Disable Delay Time: $t_{\text{PZH}}, t_{\text{PHZ}}$ $t_{\text{PZL}}, t_{\text{PLZ}}$	5	—	300	600	ns
	10	—	120	240	
	15	—	85	170	
Output Transition Time: $t_{\text{THL}}, t_{\text{TLH}}$	5	—	100	200	ns
	10	—	50	100	
	15	—	40	80	
Minimum Setup Time: Data to Clock $t_{\text{S(D)}}$ Write Enable to Clock $t_{\text{S(WE)}}$ Write Address to Clock $t_{\text{S(WA)}}$	5	—	-95	0	ns
	10	—	-35	0	
	15	—	-20	0	
Clock Rise and Fall Time: $t_{\text{rCL}}, t_{\text{fCL}}$	5	—	—	15	$\mu\text{s}$
	10	—	—	5	
	15	—	—	5	
Minimum Hold Time: Data to Clock $t_{\text{H(D)}}$ Write Enable to Clock $t_{\text{H(WE)}}$ Write Address to Clock $t_{\text{H(WA)}}$	5	—	110	220	ns
	10	—	50	100	
	15	—	40	80	
Maximum Clock Input Frequency, $f_{\text{CL}}$	5	1.5	3	—	MHz
	10	3.5	7	—	
	15	4.5	9	—	
Minimum Clock Pulse Width, Clock or Write Enable Write Address	5	—	175	350	ns
	10	—	65	130	
	15	—	45	90	
Average Input Capacitance, (Any Input) $C_I$	5	—	150	300	ns
	10	—	75	150	
	15	—	45	90	
Average Input Capacitance, (Any Input) $C_I$	—	—	5	7.5	pF

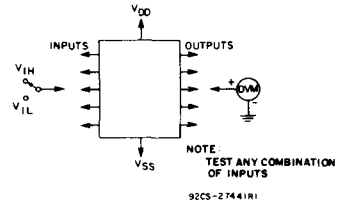

Fig. 13 - Input-voltage test circuit.

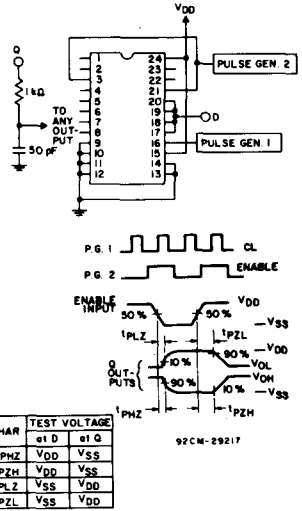

Fig. 14 - Output-enable-delay-times test circuit and waveforms.

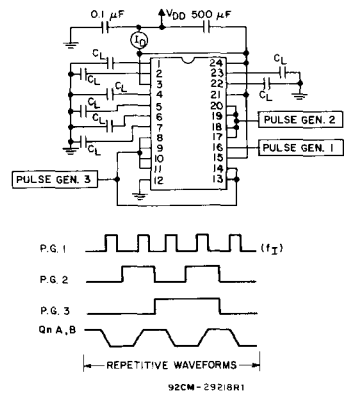

Fig. 15 - Power-dissipation test circuit and waveforms.

# CD40257B Types

## CMOS Quad 2-Line-to-1-Line Data Selector/Multiplexer

High-Voltage Types (20-Volt Rating)

The RCA-CD40257B is a Data Selector/Multiplexer featuring three-state outputs which can interface directly with and drive data lines of bus-oriented systems.

The CD40257B types are supplied in 16-lead hermetic dual-in-line ceramic packages (D and F suffixes), 16-lead dual-in-line plastic packages (E suffix), 16-lead ceramic flat packages (K suffix), and in chip form (H suffix).

### MAXIMUM RATINGS, Absolute-Maximum Values:

DC SUPPLY-VOLTAGE RANGE, (V <sub>DD</sub> ) (Voltages referenced to V <sub>SS</sub> Terminal)	-0.5 to +20 V
INPUT VOLTAGE RANGE, ALL INPUTS	-0.5 to V <sub>DD</sub> +0.5 V
DC INPUT CURRENT, ANY ONE INPUT	±10 mA
POWER DISSIPATION PER PACKAGE (P <sub>D</sub> ):	
For T <sub>A</sub> = -40 to +60°C (PACKAGE TYPE E)	500 mW
For T <sub>A</sub> = +60 to +85°C (PACKAGE TYPE E)	Derate Linearly at 12 mW/°C to 200 mW
For T <sub>A</sub> = -55 to +100°C (PACKAGE TYPES D, F, K)	500 mW
For T <sub>A</sub> = +100 to +125°C (PACKAGE TYPES D, F, K)	Derate Linearly at 12 mW/°C to 200 mW
DEVICE DISSIPATION PER OUTPUT TRANSISTOR:	
For T <sub>A</sub> = FULL PACKAGE-TEMPERATURE RANGE (All Package Types)	100 mW
OPERATING-TEMPERATURE RANGE (T <sub>A</sub> ):	
PACKAGE TYPES D, F, K, H	-55 to +125°C
PACKAGE TYPE E	-40 to +85°C
STORAGE TEMPERATURE RANGE (T <sub>stg</sub> )	-65 to +150°C
LEAD TEMPERATURE (DURING SOLDERING):	
At distance 1/16 ± 1/32 inch (1.59 ± 0.79 mm) from case for 10 s max.	+265°C

### Features:

- 3-state outputs
- Standardized, symmetrical output characteristics
- 100% tested for quiescent current at 20 V
- Maximum input current of 1 μA at 18 V over full package-temperature range; 100 nA at 18 V and 25°C
- Noise margin (over full package-temperature range):
  - 1 V at V<sub>DD</sub> = 5 V
  - 2 V at V<sub>DD</sub> = 10 V
  - 2.5 V at V<sub>DD</sub> = 15 V
- 5-V, 10-V, and 15-V parametric ratings
- Meets all requirements of JEDEC Tentative Standard No. 13A, "Standard Specifications for Description of 'B' Series CMOS Devices"

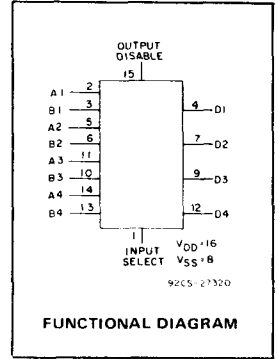

### Applications:

- Digital Multiplexing
- Shift-right/shift-left registers
- True/complement selection

### RECOMMENDED OPERATING CONDITIONS

For maximum reliability, nominal operating conditions should be selected so that operation is always within the following ranges:

CHARACTERISTIC	LIMITS		UNITS
	Min.	Max.	
Supply-Voltage Range (For T <sub>A</sub> = Full Package-Temperature Range)	3	18	V

### TRUTH TABLE

3-STATE OUTPUT DISABLE	INPUTS		OUTPUT	
	SELECT	A	B	D
1	X	X	X	Z
0	0	0	X	0
0	0	1	X	1
0	1	X	0	0
0	1	X	1	1

X = DON'T CARE LOGIC 1 = HIGH  
LOGIC 0 = LOW Z = HIGH IMPEDANCE

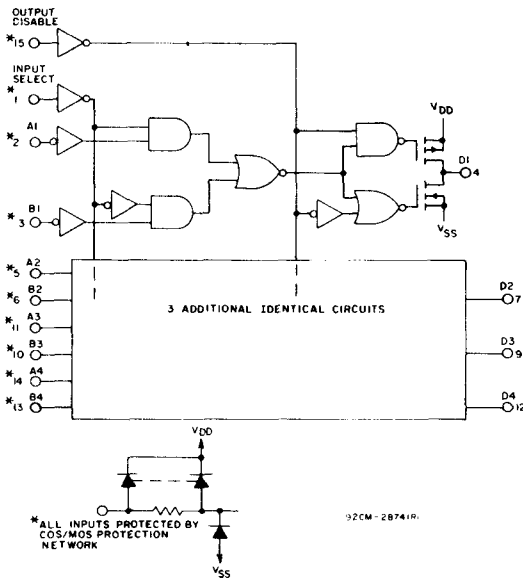

Fig. 1 - Logic diagram for CD40257B.

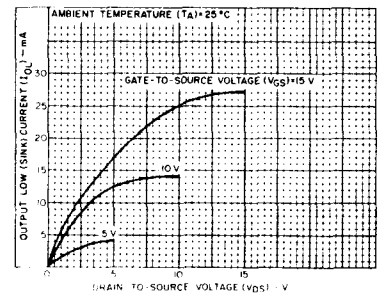

Fig. 2 - Typical output low (sink) current characteristics.

## STATIC ELECTRICAL CHARACTERISTICS

CHARACTERISTIC	CONDITIONS			LIMITS AT INDICATED TEMPERATURES (°C)							UNITS
	V <sub>O</sub> (V)	V <sub>IN</sub> (V)	V <sub>DD</sub> (V)	Values at -55, +25, +125 Apply to D, F, K, H Packages				Values at -40, +25, +85 Apply to E Pkgs.			
				-55	-40	+85	+125	+25			
								Min.	Typ.	Max.	
Quiescent Device Current I <sub>DD</sub> Max.	-	0.5	5	1	1	30	30	-	0.02	1	μA
	-	0.10	10	2	2	60	60	-	0.02	2	
	-	0.15	15	4	4	120	120	-	0.02	4	
	-	0.20	20	20	20	600	600	-	0.04	20	
Output Low (Sink) Current, I <sub>OL</sub> Min.	0.4	0.5	5	0.64	0.61	0.42	0.36	0.51	1	-	mA
	0.5	0.10	10	1.6	1.5	1.1	0.9	1.3	2.6	-	
	1.5	0.15	15	4.2	4	2.8	2.4	3.4	6.8	-	
	4.6	0.5	5	-0.64	-0.61	-0.42	-0.36	-0.51	-1	-	
Output High (Source) Current, I <sub>OH</sub> Min.	2.5	0.5	5	-2	-1.8	-1.3	-1.15	-1.6	-3.2	-	mA
	9.5	0.10	10	-1.6	-1.5	-1.1	-0.9	-1.3	-2.6	-	
	13.5	0.15	15	-4.2	-4	-2.8	-2.4	-3.4	-6.8	-	
	-	-	-	-	-	-	-	-	-	-	
Output Voltage: Low-Level, V <sub>OL</sub> Max.	-	0.5	5	0.05				-	0	0.05	V
	-	0.10	10	0.05				-	0	0.05	
	-	0.15	15	0.05				-	0	0.05	
Output Voltage: High-Level, V <sub>OH</sub> Min.	-	0.5	5	4.95				4.95	5	-	V
	-	0.10	10	9.95				9.95	10	-	
	-	0.15	15	14.95				14.95	15	-	
Input Low Voltage, V <sub>IL</sub> Max.	0.5, 4.5	-	5	1.5				-	-	1.5	V
	1.9	-	10	3				-	-	3	
	1.5, 13.5	-	15	4				-	-	4	
Input High Voltage, V <sub>IH</sub> Min.	0.5, 4.5	-	5	3.5				3.5	-	-	V
	1.9	-	10	7				7	-	-	
	1.5, 13.5	-	15	11				11	-	-	
Input Current, I <sub>IN</sub> Max.	-	0.18	18	±0.1	±0.1	±1	±1	-	±10 <sup>-5</sup>	±0.1	μA
3-State Output Leakage Current I <sub>OUT</sub> Max.	-	0.18	18	±0.4	±0.4	±12	±12	-	±10 <sup>-4</sup>	±0.4	μA

DYNAMIC ELECTRICAL CHARACTERISTICS at T<sub>A</sub> = 25°C; Input t<sub>r</sub>, t<sub>f</sub> = 20 ns, C<sub>L</sub> = 50 pF, R<sub>L</sub> = 200 KΩ

CHARACTERISTIC	TEST CONDITIONS	LIMITS		UNITS	
		V <sub>DD</sub> (V)	Typ.		Max.
Propagation Delay Time: Data Input to Output, t <sub>PHL</sub> , t <sub>PLH</sub>		5	150	300	ns
		10	70	140	
		15	50	100	
Select to Output, t <sub>PHL</sub> , t <sub>PLH</sub>		5	190	380	ns
		10	85	170	
		15	65	130	
Output Disable to Output, t <sub>PHL</sub> , t <sub>PLH</sub>		5	95	190	ns
		10	50	100	
		15	40	80	
Transition Time, t <sub>THL</sub> , t <sub>TLH</sub>		5	100	200	ns
		10	50	100	
		15	40	80	
Input Capacitance, C <sub>IN</sub>	Any Input	-	5	7.5	pF

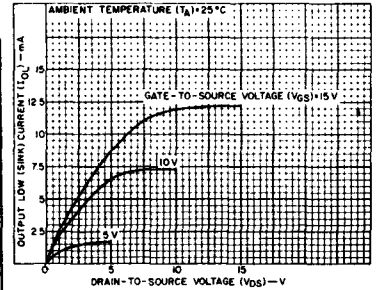

Fig. 3 - Minimum output low (sink) current characteristics.

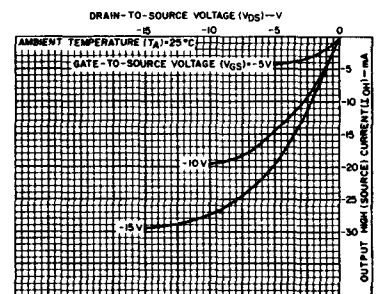

Fig. 4 - Typical output high (source) current characteristics.

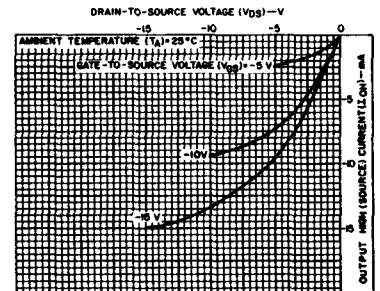

Fig. 5 - Minimum output high (source) current characteristics.

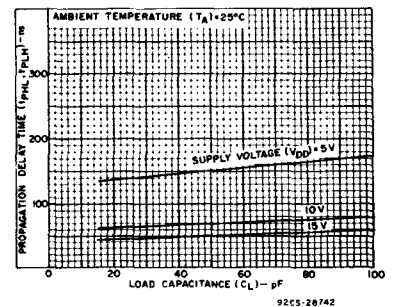

Fig. 6 - Typical propagation delay time as a function of load capacitance (DATA INPUT to OUTPUT).

# CD40257B Types

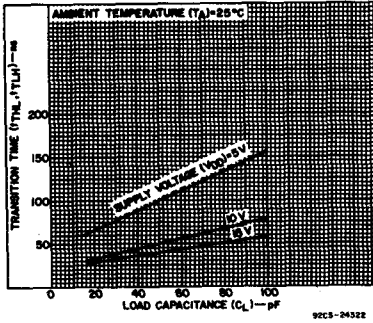

Fig. 7 - Typical transition time as a function of load capacitance.

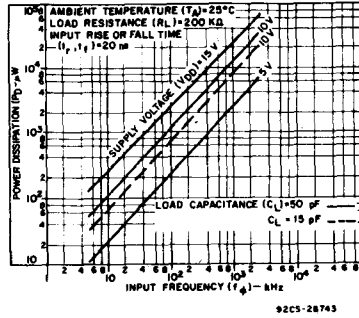

Fig. 8 - Typical dynamic power dissipation as a function of input frequency (one INPUT to one OUTPUT).

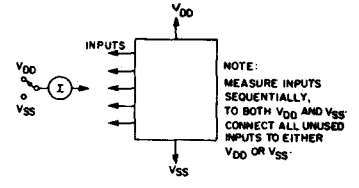

Fig. 9 - Input current test circuit.

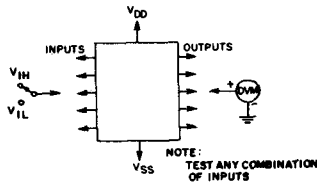

Fig. 10 - Input voltage test circuit.

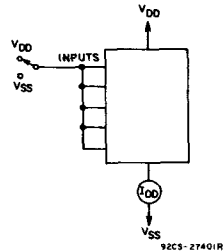
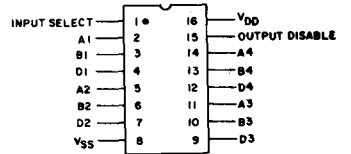
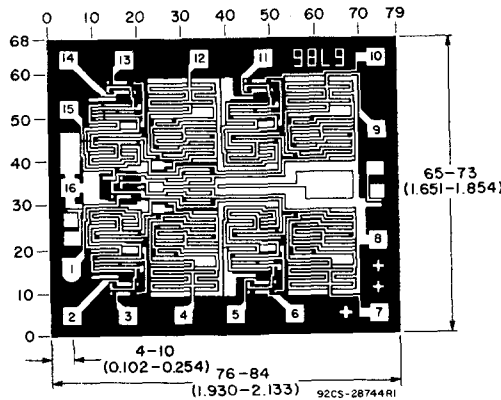

Fig. 11 - Quiescent device current test circuit.



TERMINAL ASSIGNMENT

## Dimensions and pad layout for CD40257BH.



Dimensions in parentheses are in millimeters and are derived from the basic inch dimensions as indicated. Grid graduations are in mils (10<sup>-3</sup> inch).

The photographs and dimensions of each CMOS chip represent a chip when it is part of the wafer. When the wafer is separated into individual chips, the angle of cleavage may vary with respect to the chip face for different chips. The actual dimensions of the isolated chip, therefore, may differ slightly from the nominal dimensions shown. The user should consider a tolerance of -3 mils to +16 mils applicable to the nominal dimensions shown.

---

# **CMOS A-Series Integrated Circuits**

## **Technical Data**

# CD4000A, CD4001A, CD4002A, CD4025A Types

## CMOS NOR Gates

- Dual 3 Input plus Inverter—CD4000A
- Quad 2 Input—CD4001A
- Dual 4 Input—CD4002A
- Triple 3 Input—CD4025A

The RCA-CD4000A, CD4001A, CD4002A, and CD4025A NOR gates provide the system designer with direct implementation of the NOR function and supplement the existing family of CMOS gates.

These types are supplied in 14-lead hermetic dual-in-line ceramic packages (D and F suffixes), 14-lead dual-in-line plastic packages (E suffix), 14-lead ceramic flat packages (K suffix), and in chip form (H suffix).

### Features:

- Quiescent current specified to 15 V
- Maximum input leakage of 1  $\mu$ A at 15 V (full package-temperature range)
- 1-V noise margin (full package-temperature range)

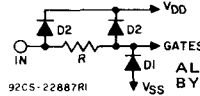
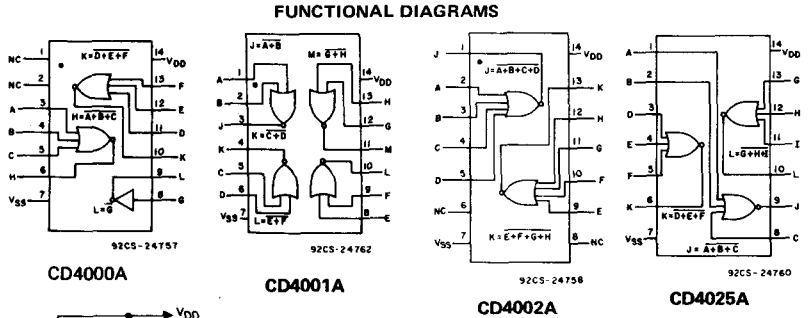

ALL INPUTS ARE PROTECTED BY COS/MOS PROTECTION NETWORK

- MAXIMUM RATINGS, Absolute-Maximum Values:**
- STORAGE-TEMPERATURE RANGE ( $T_{stg}$ ) . . . . . -65 to +150°C
  - OPERATING-TEMPERATURE RANGE ( $T_A$ ):
    - PACKAGE TYPES D, F, K, H . . . . . -55 to +125°C
    - PACKAGE TYPE E . . . . . -40 to +85°C
  - DC SUPPLY-VOLTAGE RANGE, ( $V_{DD}$ ) (Voltages referenced to  $V_{SS}$  Terminal): . . . . . -0.5 to +15 V
  - POWER DISSIPATION PER PACKAGE ( $P_D$ ):
    - FOR  $T_A = -40$  to +60°C (PACKAGE TYPE E) . . . . . 500 mW
    - FOR  $T_A = +60$  to +85°C (PACKAGE TYPE E) . . . . . Derate Linearly at 12 mW/°C to 200 mW
    - FOR  $T_A = -55$  to +100°C (PACKAGE TYPES D, F, K) . . . . . 500 mW
    - FOR  $T_A = +100$  to +125°C (PACKAGE TYPES D, F, K) . . . . . Derate Linearly at 12 mW/°C to 200 mW
  - DEVICE DISSIPATION PER OUTPUT TRANSISTOR
    - FOR  $T_A =$  FULL PACKAGE-TEMPERATURE RANGE (ALL PACKAGE TYPES) . . . . . 100 mW
  - INPUT VOLTAGE RANGE, ALL INPUTS . . . . . -0.5 to  $V_{DD} + 0.5$  V
  - LEAD TEMPERATURE (DURING SOLDERING):
    - At distance 1/16  $\pm$  1/32 inch (1.59  $\pm$  0.79 mm) from case for 10 s max. . . . . +265°C

### RECOMMENDED OPERATING CONDITIONS

For maximum reliability, nominal operating conditions should be selected so that operation is always within the following ranges:

CHARACTERISTIC	LIMITS		UNITS
	MIN.	MAX.	
Supply-Voltage Range (For $T_A =$ Full Package-Temperature Range)	3	12	V

### DYNAMIC ELECTRICAL CHARACTERISTICS at $T_A = 25^\circ\text{C}$ , $C_L = 15$ pF, Input $t_r, t_f = 20$ ns

CHARACTERISTIC	TEST CONDITIONS	LIMITS				UNITS
		D, F, K, H PACKAGES		E PACKAGE		
		TYP.	MAX.	TYP.	MAX.	
Propagation Delay Time: High-to-Low Level, $t_{PHL}$	$V_{DD}$ (Volts)					
	5	35/60	50/95	35/60	80/95	ns
10	25/35	40/60	25/35	55/60		
Low-to-High Level, $t_{PLH}$	5	35/80	95/120	35/80	120/120	ns
	10	25/40	45/65	25/40	65/65	
Transition Time: High-to-Low Level, $t_{THL}$	5	65	125	65	200	ns
	10	35	70	35	115	
Low-to-High Level, $t_{TLH}$	5	65	175	65	300	ns
	10	35	75	35	125	
Input Capacitance, $C_I$	Any Input	5	—	5	—	pF

Note: Numbers to the right of slash mark are for CD4025A; numbers to the left of slash mark are for 4000A, 4001A, and 4002A.

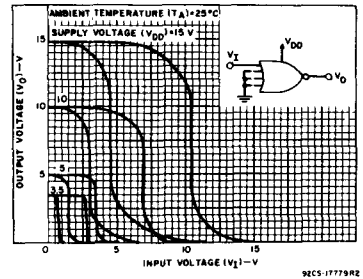

Fig. 1 - Minimum and maximum voltage transfer characteristics.

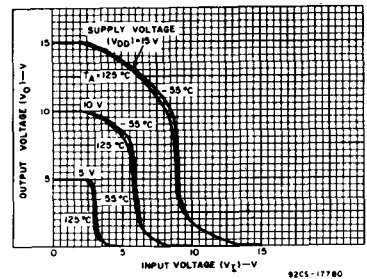

Fig. 2 - Typical voltage transfer characteristics as a function of temperature.



# CD4000A, CD4001A, CD4002A, CD4025A Types

## STATIC ELECTRICAL CHARACTERISTICS

CHARACTERISTICS	CONDITIONS			LIMITS AT INDICATED TEMPERATURES (°C)								UNITS
	V <sub>O</sub> (V)	V <sub>IN</sub> (V)	V <sub>DD</sub> (V)	D, F, K, H PACKAGES				E PACKAGE				
				-55	+25		+125	-40	+25		+85	
				TYP.	LIMIT	TYP.	LIMIT	TYP.	LIMIT	TYP.	LIMIT	
Quiescent Device Current, I <sub>L</sub> Max.	-	-	5	0.05	0.001	0.05	3	0.5	0.005	0.5	15	μA
	-	-	10	0.1	0.001	0.1	6	5	0.005	5	30	
	-	-	15	2	0.02	2	40	50	0.005	50	500	
Output Voltage: Low Level, V <sub>OL</sub>	-	0, 5	5	0 Typ.; 0.05 Max								V
	-	0, 10	10	0 Typ.; 0.05 Max								
High Level V <sub>OH</sub>	-	0, 5	5	4.95 Min.; 5 Typ.								V
	-	0, 10	10	9.95 Min.; 10 Typ.								
Noise Immunity: Inputs Low, V <sub>NL</sub>	3.6	-	5	1.5 Min.; 2.25 Typ.								V
	7.2	-	10	3 Min.; 4.5 Typ.								
Inputs High V <sub>NH</sub>	1.4	-	5	1.5 Min.; 2.25 Typ.								V
	2.8	-	10	3 Min.; 4.5 Typ.								
Noise Margin: Inputs Low, V <sub>NML</sub>	4.5	-	5	1 Min.								V
	9	-	10	1 Min.								
Inputs High, V <sub>NMH</sub>	0.5	-	5	1 Min.								V
	1	-	10	1 Min.								
Output Drive Current: N-Channel (Sink), I <sub>D</sub> N Min.	0.4	-	5	0.5	1	0.4	0.28	0.35	1	0.3	0.24	mA
	0.5	-	10	1.1	2.5	0.9	0.65	0.72	2.5	0.6	0.48	
	2.5	-	5	-0.62	-2	-0.5	-0.35	-0.35	-2	-0.3	-0.24	
	9.5	-	10	-0.62	-1	-0.5	-0.35	-0.3	-1	-0.25	-0.2	
Input Leakage Current, I <sub>IL</sub> , I <sub>IH</sub>	Any Input			15								μA
				±10 <sup>-5</sup> Typ., ±1 Max.								

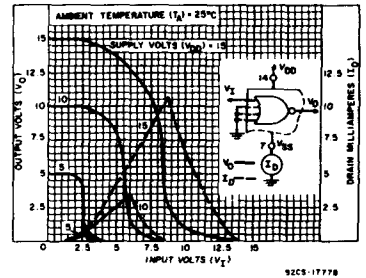

Fig. 3 - Typical current & voltage transfer characteristics.

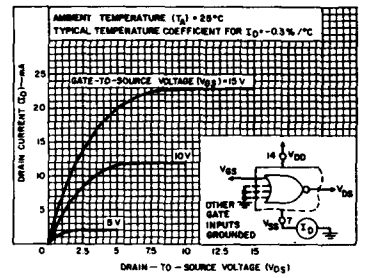

Fig. 4 - Typical n-channel drain characteristics.

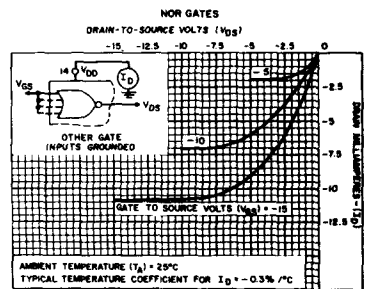

Fig. 5 - Typical p-channel drain characteristics.

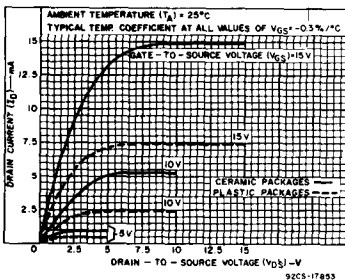

Fig. 6 - Minimum n-channel drain characteristics.

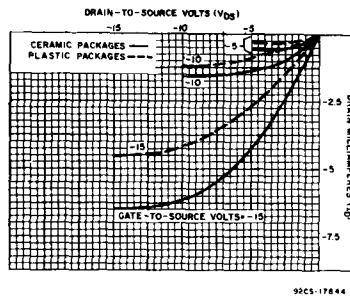

Fig. 7 - Minimum p-channel drain characteristics.

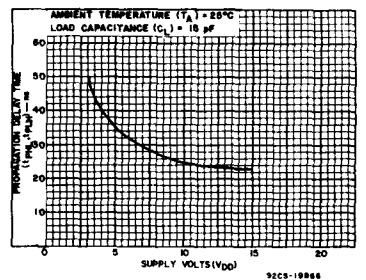

Fig. 8 - Typical propagation delay time vs. V<sub>DD</sub>.

# CD4000A, CD4001A, CD4002A, CD4025A Types

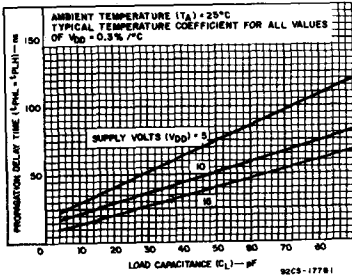

Fig. 9 — Typical propagation delay time vs. C<sub>L</sub>.

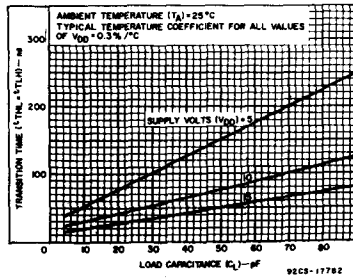

Fig. 10 — Typical transition time vs. C<sub>L</sub>.

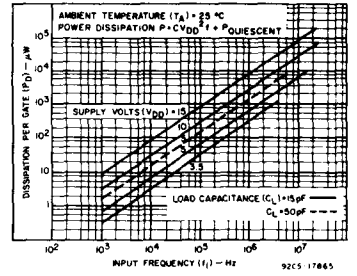

Fig. 11 — Typical dissipation characteristics.

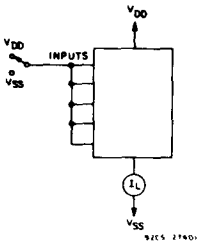
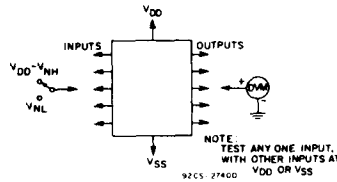

Fig. 12 — Quiescent device current test circuit.



NOTE:  
CD4000, CD4002, CD4025—  
TEST ANY ONE INPUT WITH  
OTHER INPUTS AT V<sub>DD</sub> OR V<sub>SS</sub>.  
CD4001—TEST ANY  
COMBINATION OF INPUTS.

Fig. 13 — Noise immunity test circuit.

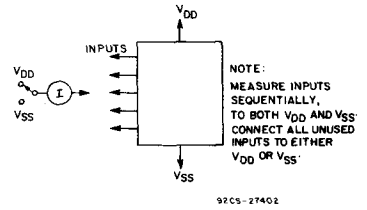

Fig. 14 — Input leakage current test circuit.

# CMOS 18-Stage Static Shift Register

The RCA-CD4006A types are comprised of 4 separate shift register sections: two sections of four stages and two sections of five stages with an output tap at the fourth stage. Each section has an independent single-rail data path.

A common clock signal is used for all stages. Data are shifted to the next stage on negative-going transitions of the clock. Through appropriate connections of inputs and outputs, multiple register sections of 4, 5, 8, and 9 stages or single register sections of 10, 12, 13, 14, 16, 17 and 18 stages can be implemented using one CD4006A package. Longer shift register sections can be assembled by using more than one CD4006A.

**Features:**

- Fully static operation
- Shifting rates up to 5 MHz
- Permanent register storage with clock line high or low — no information recirculation required
- Quiescent current specified to 15 V
- Maximum input leakage current of 1  $\mu$ A at 15 V (full package-temperature range)
- 1-V noise margin (full package-temperature range)

These types are supplied in 14-lead hermetic dual-in-line ceramic packages (D and F suffixes), 14-lead dual-in-line plastic packages (E suffix), 14-lead ceramic flat packages (K suffix), and in chip form (H suffix).

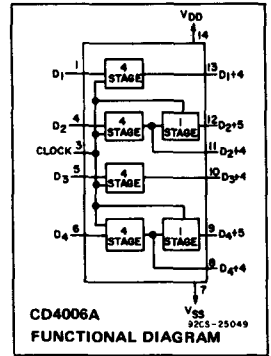

**Applications:**

- Serial shift registers
- Time delay circuits
- Frequency division

**MAXIMUM RATINGS, Absolute-Maximum Values:**

STORAGE-TEMPERATURE RANGE ( $T_{stg}$ )	-65 to +150°C
OPERATING-TEMPERATURE RANGE ( $T_A$ ):	
PACKAGE TYPES D, F, K, H	-55 to +125°C
PACKAGE TYPE E	-40 to +85°C
DC SUPPLY-VOLTAGE RANGE, ( $V_{DD}$ )	
(Voltages referenced to $V_{SS}$ Terminal)	-0.5 to +15 V
POWER DISSIPATION PER PACKAGE ( $P_D$ ):	
FOR $T_A = -40$ to +60°C (PACKAGE TYPE E)	500 mW
FOR $T_A = +60$ to +85°C (PACKAGE TYPE E)	Derate Linearly at 12 mW/°C to 200 mW
FOR $T_A = -55$ to +100°C (PACKAGE TYPES D, F, K)	500 mW
FOR $T_A = +100$ to +125°C (PACKAGE TYPES D, F, K)	Derate Linearly at 12 mW/°C to 200 mW
DEVICE DISSIPATION PER OUTPUT TRANSISTOR	
FOR $T_A =$ FULL PACKAGE-TEMPERATURE RANGE (ALL PACKAGE TYPES)	100 mW
INPUT VOLTAGE RANGE, ALL INPUTS	-0.5 to $V_{DD} + 0.5$ V
LEAD TEMPERATURE (DURING SOLDERING):	
At distance 1/16 $\pm$ 1/32 inch (1.59 $\pm$ 0.79 mm) from case for 10 s max.	+265°C

**RECOMMENDED OPERATING CONDITIONS at  $T_A = 25^\circ\text{C}$ , Except as Noted.**  
 For maximum reliability, nominal operating conditions should be selected so that operation is always within the following ranges:

CHARACTERISTIC	$V_{DD}$ (V)	LIMITS				UNITS
		D, F, K, H PACKAGES		E Package		
		Min.	Max.	Min.	Max.	
Supply-Voltage Range (For $T_A =$ Full Package-Temperature Range)		3	12	3	12	V
Data Setup Time, $t_s$	5 10	80 40	-	100 50	-	ns
Clock Pulse Width, $t_{Wp}$	5 10	500 200	-	830 250	-	ns
Clock Input Frequency, $f_{CL}$	5 10	dc dc	1 2.5	dc dc	0.6 2	MHz
Clock Rise and Fall Time, $t_{rCL}, t_{fCL}^*$	5 10	- -	15 5	- -	15 5	$\mu$ s

\* If more than one unit is cascaded  $t_{rCL}$  should be made less than or equal to the sum of the transition time and the fixed propagation delay of the output of the driving stage for the estimated capacitive load.

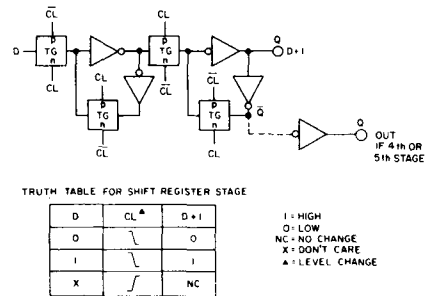

Fig. 1 — Logic diagram and truth table (one register stage).

# CD4006A Types

## STATIC ELECTRICAL CHARACTERISTICS

Characteristic	Conditions			Limits at Indicated Temperatures (°C)								Units
				D, F, K, H Packages				E Package				
	V <sub>O</sub> (V)	V <sub>IN</sub> (V)	V <sub>DD</sub> (V)	-55	+25		+125	-40	+25		+85	
Quiescent Device Current, I <sub>L</sub> Max.	-	-	5	0.5	0.01	0.5	30	5	0.03	5	70	μA
	-	-	10	1	0.01	1	60	10	0.05	10	140	
Output Voltage: Low-Level, VOL	-	5	5	0 Typ.; 0.05 Max.								V
	-	10	10	0 Typ.; 0.05 Max.								
High Level, VOH	-	0	5	4.95 Min.; 5 Typ.								V
	-	0	10	9.95 Min.; 10 Typ.								
Noise Immunity: Inputs Low, VNL	4.2	-	5	1.5 Min.; 2.25 Typ.								V
	9	-	10	3 Min.; 4.5 Typ.								
Inputs High, VNH	0.8	-	5	1.5 Min.; 2.25 Typ.								V
	1	-	10	3 Min.; 4.5 Typ.								
Noise Margin: Inputs Low, V <sub>NML</sub>	4.5	-	5	1 Min.								V
	9	-	10	1 Min.								
Inputs High, V <sub>NMH</sub>	0.5	-	5	1 Min.								V
	1	-	10	1 Min.								
Output Drive Current: n-Channel (Sink), I <sub>DN</sub> Min.	0.5	-	5	0.155	0.25	0.125	0.085	0.072	0.25	0.06	0.048	mA
	0.5	-	10	0.31	0.5	0.25	0.175	0.15	0.5	0.125	0.1	
p-Channel (Source), I <sub>DP</sub> Min.	4.5	-	5	-0.125	-0.15	-0.1	-0.07	-0.06	-0.15	-0.05	-0.04	mA
	9.5	-	10	-0.25	-0.3	-0.2	-0.14	-0.12	-0.3	-0.1	-0.08	
Input Leakage Current, I <sub>IL</sub> , I <sub>IH</sub>	Any Input	-	15	±10 <sup>-5</sup> Typ., ±1 Max.								μA

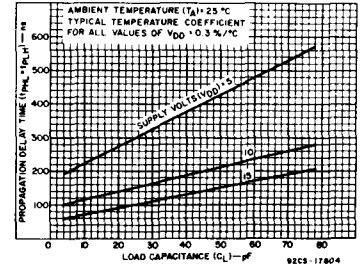

Fig. 2 - Typical propagation delay time vs. load capacitance.

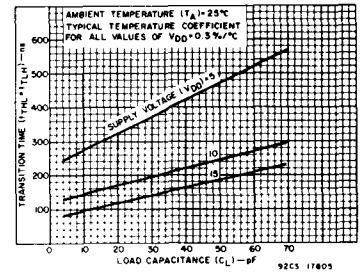

Fig. 3 - Typical transition time vs. load capacitance.

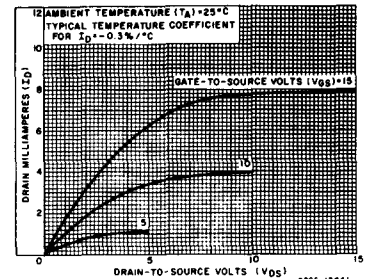

Fig. 5 - Typical output n-channel drain characteristics.

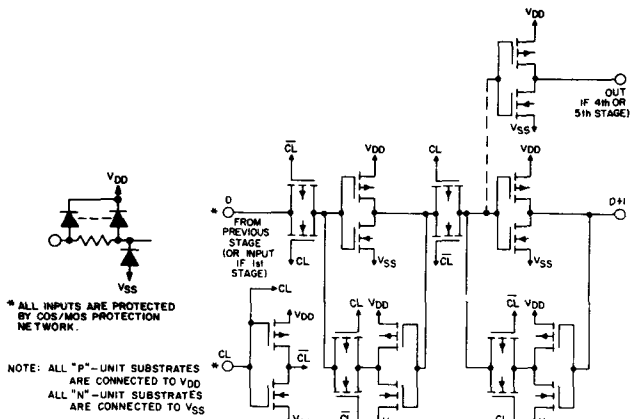

Fig. 4 - Schematic diagram (one register stage).

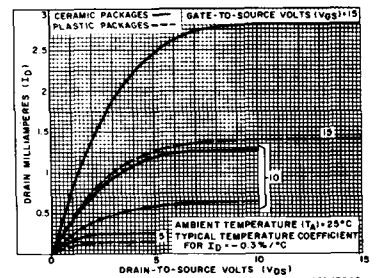

Fig. 6 - Minimum output n-channel drain characteristics.

# CD4006A Types

DYNAMIC ELECTRICAL CHARACTERISTICS at  $T_A = 25^\circ\text{C}$ , Input  $t_r, t_f = 20\text{ ns}$ ,  
 $C_L = 15\text{ pF}, R_L = 200\text{ k}\Omega$

CHARACTERISTIC	TEST CONDITIONS	LIMITS						UNITS	
		V <sub>DD</sub> (V)	D, F, K, H Packages			E Package			
			Min.	Typ.	Max.	Min.	Typ.		Max.
Propagation Delay Time; $t_{PLH}, t_{PHL}$	5	—	250	400	—	250	500	ns	
	10	—	125	200	—	125	250		
Transition Time; $t_{THL}, t_{TLH}$	5	—	250	400	—	250	500	ns	
	10	—	125	200	—	125	250		
Maximum Clock Input Frequency, $f_{CL}$	5	1	2.5	—	0.6	2.5	—	MHz	
	10	2.5	5	—	2	5	—		
Minimum Clock Pulse Width, $t_W$	5	—	200	500	—	200	830	ns	
	10	—	100	200	—	100	250		
Clock Rise & Fall Time; $t_{rCL}, t_{fCL}^*$	5	—	—	15	—	—	15	$\mu\text{s}$	
	10	—	—	5	—	—	5		
Minimum Data Set Up Time, $t_S$	5	—	50	80	—	50	100	ns	
	10	—	25	40	—	25	50		
Average Input Capacitance, $C_i$	Data Input	—	5	—	—	5	—	pF	
	Clock Input	—	30	—	—	30	—		

\* If more than one unit is cascaded  $t_{rCL}$  should be made less than or equal to the sum of the transition time and the fixed propagation delay of the output of the driving stage for the estimated capacitive load.

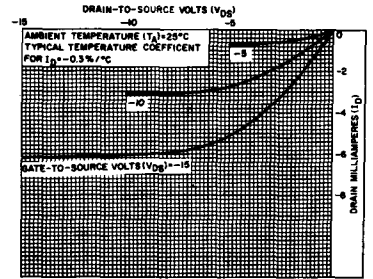

Fig. 7 - Typical output p-channel drain characteristics.

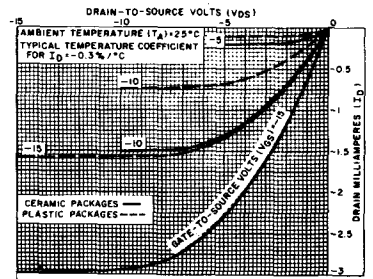

Fig. 8 - Minimum output p-channel drain characteristics.

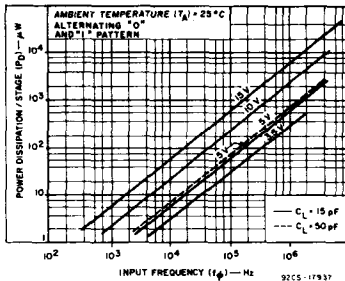

Fig. 9 - Typical dissipation characteristics.

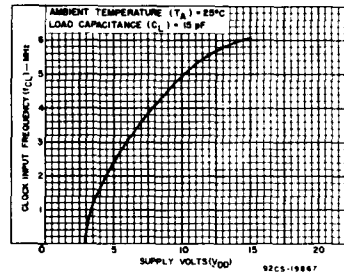

Fig. 10 - Typical clock input frequency vs. supply voltage.

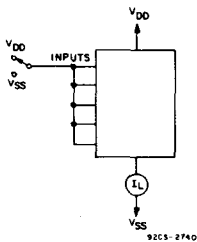

Fig. 11 - Quiescent device current test circuit.

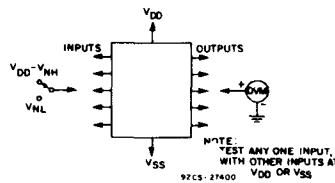

Fig. 12 - Noise immunity test circuit.

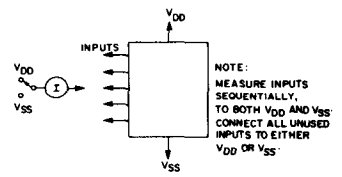

Fig. 13 - Input leakage current test circuit.

# CD4007A Types

## CMOS Dual Complementary Pair Plus Inverter

The RCA-CD4007A types are comprised of three n-channel and three p-channel enhancement-type MOS transistors. The transistor elements are accessible through the package terminals to provide a convenient means for constructing the various typical circuits as shown in Fig. 2.

More complex functions are possible using multiple packages. Numbers shown in parentheses indicate terminals that are connected together to form the various configurations listed.

These types are supplied in 14-lead hermetic dual-in-line ceramic packages (D and F suffixes), 14-lead dual-in-line plastic packages (E suffix), 14-lead ceramic flat packages (K suffix), and in chip form (H suffix).

### Features:

- Medium-speed operation. . . . .  
 $t_{PHL} = t_{PLH} = 20$  ns (typ.) at  $C_L = 15$  pF,  $+V_{DD} = 10$  V
- Low "high" and "low" output impedance. 500  $\Omega$  (typ.) at  $V_{DD} - V_{SS} = 10$  V
- Quiescent current specified to 15 V
- Maximum input leakage current of 1  $\mu$ A at 15 V (full package-temperature range)
- 1-V noise margin (full package-temperature range)

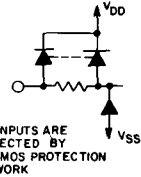
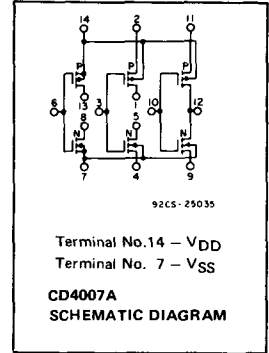

### MAXIMUM RATINGS, Absolute-Maximum Values:

STORAGE-TEMPERATURE RANGE ( $T_{STG}$ )	-65 to +150°C
OPERATING-TEMPERATURE RANGE ( $T_A$ )	
PACKAGE TYPES D, F, K, H	-55 to +125°C
PACKAGE TYPE E	-40 to +85°C
DC SUPPLY-VOLTAGE RANGE, ( $V_{DD}$ ) (Voltages referenced to $V_{SS}$ Terminal)	-0.5 to +15 V
POWER DISSIPATION PER PACKAGE ( $P_D$ )	
FOR $T_A = -40$ to +60°C (PACKAGE TYPE E)	500 mW
FOR $T_A = +60$ to +85°C (PACKAGE TYPE E)	Derate Linearly at 12 mW/°C to 200 mW
FOR $T_A = -55$ to +100°C (PACKAGE TYPES D, F, K)	500 mW
FOR $T_A = +100$ to +125°C (PACKAGE TYPES D, F, K)	Derate Linearly at 12 mW/°C to 200 mW
DEVICE DISSIPATION PER OUTPUT TRANSISTOR FOR $T_A =$ FULL PACKAGE TEMPERATURE RANGE (ALL PACKAGE TYPES)	100 mW
INPUT VOLTAGE RANGE, ALL INPUTS LEAD TEMPERATURE (DURING SOLDERING)	-0.5 to $V_{DD} + 0.5$ V
At distance 1/16 $\pm$ 1/32 inch (1.59 $\pm$ 0.79 mm) from case for 10 s max.	+265°C

### RECOMMENDED OPERATING CONDITIONS

For maximum reliability, nominal operating conditions should be selected so that operation is always within the following ranges:

CHARACTERISTIC	LIMITS				UNITS
	D, F, K, H Packages		E Package		
	Min.	Max.	Min.	Max.	
Supply-Voltage Range (For $T_A =$ Full Package Temperature Range)	3	12	3	12	V

DYNAMIC ELECTRICAL CHARACTERISTICS at  $T_A = 25^\circ\text{C}$ , Input  $t_r, t_f = 20$  ns,  $C_L = 15$  pF,  $R_L = 200$  k $\Omega$

CHARACTERISTIC	TEST CONDITIONS	LIMITS						UNITS	
		$V_{DD}$ (V)	D, F, K, H Packages			E Package			
			Min.	Typ.	Max.	Min.	Typ.		Max.
Propagation Delay Time; $t_{PLH}, t_{PHL}$		5	35	60	35	75	ns		
Transition Time; $t_{THL}, t_{TLH}$		10	20	40	20	50	ns		
Average Input Capacitance, $C_i$	Any Input	5	50	75	30	50	pF		

### Applications:

- Extremely high-input impedance amplifiers
- Shapers
- Inverters
- Threshold detector
- Linear amplifiers

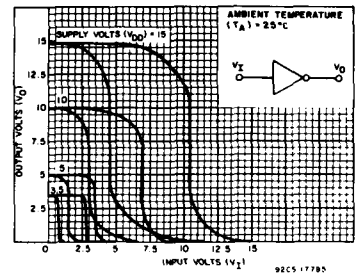

Fig. 1 — Minimum and maximum voltage-transfer characteristics for inverter.

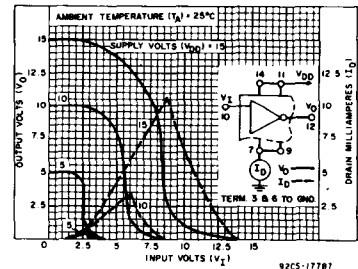

Fig. 2 — Typical current and voltage-transfer characteristics for inverter.

# CD4007A Types

## STATIC ELECTRICAL CHARACTERISTICS

Characteristic	Conditions			Limits at Indicated Temperatures (°C)									Units
				D, F, K, H Packages						E Package			
	V <sub>O</sub> (V)	V <sub>IN</sub> (V)	V <sub>DD</sub> (V)	-55	+25		+125	-40	+25		+85		
Quiescent Device Current: <i>I<sub>L</sub></i> Max.	-	-	5	0.05	0.001	0.05	3	0.5	0.005	0.5	15	μA	
	-	-	10	0.1	0.001	0.1	6	1	0.005	1	30		
	-	-	15	2	0.02	2	40	50	0.5	50	500		
Output Voltage Low Level V <sub>OL</sub>	-	5	5	0 Typ.; 0.05 Max.									V
	-	10	10	0 Typ.; 0.05 Max.									
	-	0	5	4.95 Min.; 5 Typ.									
High Level V <sub>OH</sub>	-	0	10	9.95 Min.; 10 Typ.									V
	-	0	5	1.5 Min.; 2.25 Typ.									
Noise Immunity: Inputs Low V <sub>NL</sub>	3.6	-	5	3 Min.; 4.5 Typ.									V
	7.2	-	10	1.5 Min.; 2.25 Typ.									
Inputs High V <sub>NH</sub>	1.4	-	5	3 Min.; 4.5 Typ.									V
	2.8	-	10	1 Min.									
Noise Margin: Inputs Low V <sub>NML</sub>	4.5	-	5	1 Min.									V
	9	-	10	1 Min.									
Inputs High V <sub>NMH</sub>	0.5	-	5	1 Min.									V
	1	-	10	1 Min.									
Output Drive Current: N-Channel (Sink) <i>I<sub>DN</sub></i> Min.	0.4* V <sub>I</sub> =	5	0.75	1	0.6	0.4	0.35	1	0.3	0.24	mA		
	0.5 V <sub>DD</sub>	10	1.6	2.5	1.3	0.95	1.2	2.5	1	0.8			
P-Channel (Source): <i>I<sub>DP</sub></i> Min.	2.5† V <sub>I</sub> =	5	-1.75	-4	-1.4	-1	-1.3	-4	-1.1	-0.9	mA		
	9.5 V <sub>DD</sub>	10	-1.35	-2.5	-1.1	-0.75	-0.65	-2.5	-0.55	-0.45			
Input Leakage Current: <i>I<sub>IL</sub></i> , <i>I<sub>IH</sub></i>	Any Input			±10 <sup>-5</sup> Typ., ±1 Max.									μA
	-	-	15										

\*Maximum noise-free low-level bipolar output voltage. †Minimum noise-free high-level bipolar output voltage.

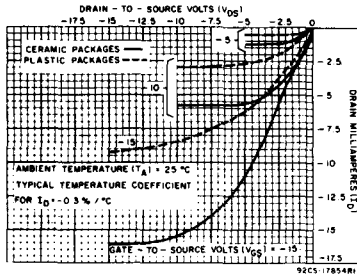

Fig. 5 - Minimum output p-channel drain characteristics.

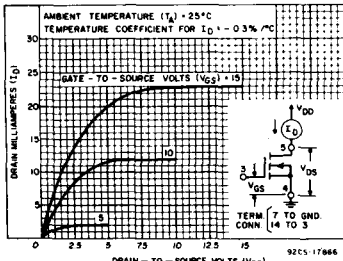

Fig. 8 - Typical output n-channel drain characteristics.

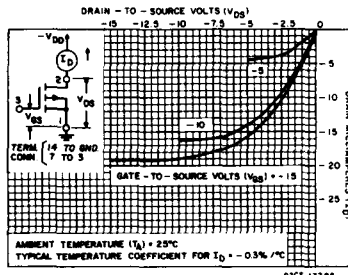

Fig. 6 - Typical output p-channel drain characteristics.

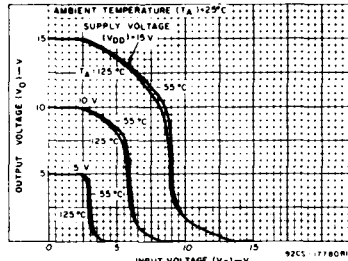

Fig. 9 - Typical voltage-transfer characteristics as a function of temperature.

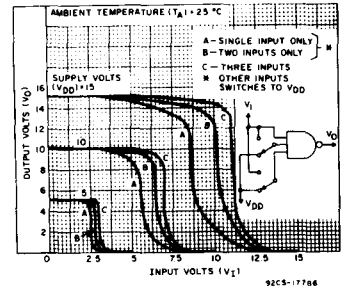

Fig. 3 - Typical voltage-transfer characteristics for NAND gate.

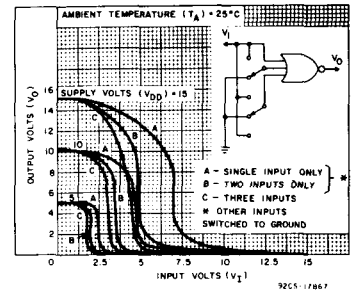

Fig. 4 - Typical voltage-transfer characteristics for NOR gate.

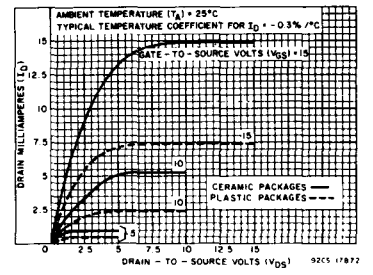

Fig. 7 - Minimum output n-channel drain characteristics.

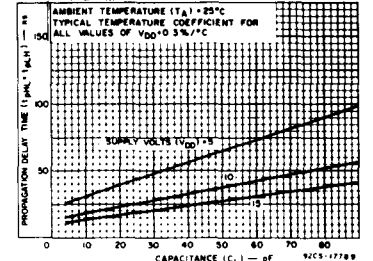

Fig. 10 - Typical propagation-delay time vs. load capacitance.

# CD4007A Types

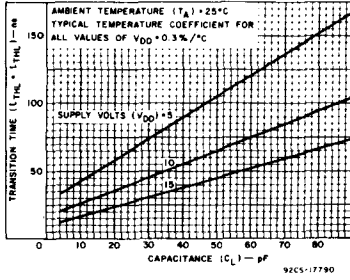

Fig. 11 — Typical transition time vs. load capacitance.

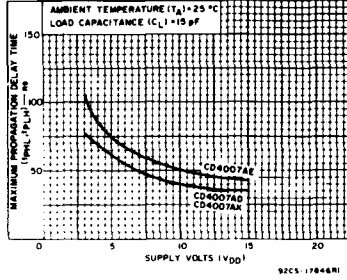

Fig. 12 — Maximum propagation delay time vs. supply voltage.

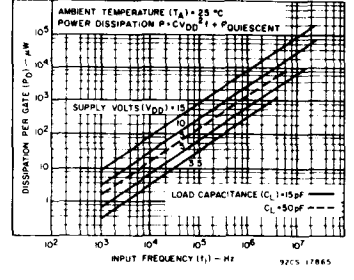
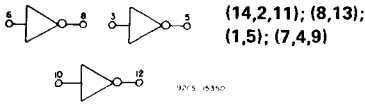
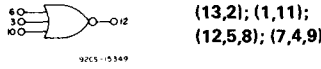

Fig. 13 — Typical dissipation characteristics.



a) Triple Inverters

(14,2,11); (8,13);  
(1,5); (7,4,9)



b) 3-Input NOR Gate

(13,2); (1,11);  
(12,5,8); (7,4,9)

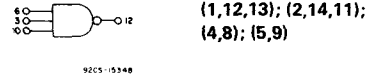

c) 3-Input NAND Gate

(1,12,13); (2,14,11);  
(4,8); (5,9)

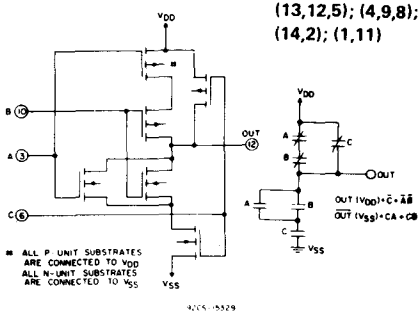

d) Tree (Relay) Logic

(13,12,5); (4,9,8);  
(14,2); (1,11)

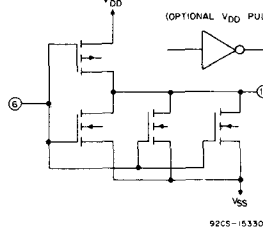

e) High Sink-Current Driver

(6,3,10); (8,5,12);  
(11,14); (7,4,9)

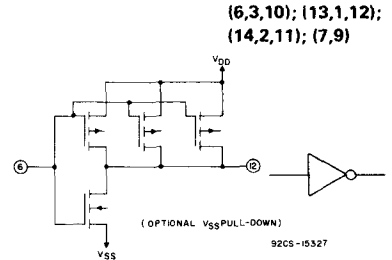

f) High Source-Current Driver

(6,3,10); (13,1,12);  
(14,2,11); (7,9)

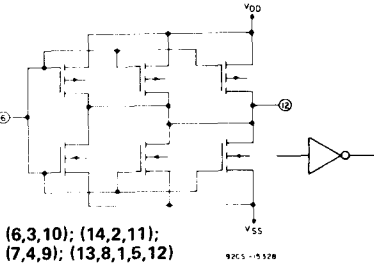

g) High Sink- and Source-Current Driver

(6,3,10); (14,2,11);  
(7,4,9); (13,8,1,5,12)

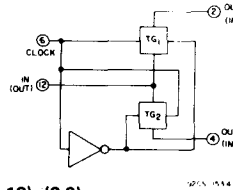

h) Dual Bi-Directional Transmission Gating

(1,5,12); (2,9);  
(11,4); (8,13,10);  
(6,3)

Fig. 14 — Sample COS/MOS logic circuit arrangements using type CD4007A.

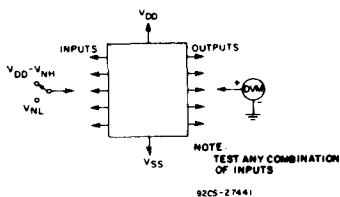

Fig. 15 — Noise-immunity test circuit.

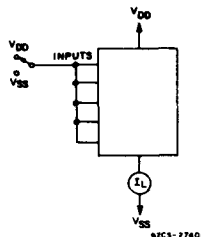

Fig. 16 — Quiescent-device-current test circuit.

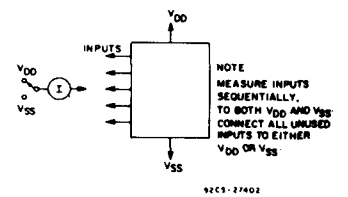

Fig. 17 — Input-leakage-current test circuit.



## CMOS 4-Bit Full Adder

With Parallel Carry Out

The RCA-CD4008A types consist of four full-adder stages with fast look-ahead carry provision from stage to stage. Circuitry is included to provide a fast "parallel-carry-out" bit to permit high-speed operation in arithmetic sections using several CD4008A's. CD4008A inputs include the four sets of bits to be added, A<sub>1</sub> to A<sub>4</sub> and B<sub>1</sub> to B<sub>4</sub>, in addition to the "Carry In" bit from a previous section. CD4008A outputs include the four sum bits, S<sub>1</sub> and S<sub>4</sub>, in addition to the high-speed "parallel-carry-out" which may be utilized at a succeeding CD4008A section.

These types are supplied in 16-lead hermetic dual-in-line ceramic packages (D and F suffixes), 16-lead dual-in-line plastic packages (E suffix), 16-lead ceramic flat packages (K suffix), and in chip form (H suffix).

### Features:

- 4 sum outputs plus parallel look-ahead carry-output
- Quiescent current specified to 15 V
- Maximum input leakage of 1 μA at 15 V (full package-temperature range)
- 1-V noise margin (full package-temperature range)

### Applications

- Binary addition/arithmetic units

### MAXIMUM RATINGS, Absolute-Maximum Values:

STORAGE-TEMPERATURE RANGE (T <sub>stg</sub> )	-65 to +150°C
OPERATING-TEMPERATURE RANGE (T <sub>A</sub> ):	
PACKAGE TYPES D, F, K, H	-55 to +125°C
PACKAGE TYPE E	-40 to +85°C
DC SUPPLY-VOLTAGE RANGE, (V <sub>DD</sub> )	-0.5 to +15 V
(Voltages referenced to V <sub>SS</sub> Terminal):	
POWER DISSIPATION PER PACKAGE (P <sub>D</sub> ):	
FOR T <sub>A</sub> = -40 to +60°C (PACKAGE TYPE E)	.500 mW
FOR T <sub>A</sub> = +60 to +85°C (PACKAGE TYPE E)	Derate Linearly at 12 mW/°C to 200 mW
FOR T <sub>A</sub> = -55 to +100°C (PACKAGE TYPES D, F, K)	.500 mW
FOR T <sub>A</sub> = +100 to +125°C (PACKAGE TYPES D, F, K)	Derate Linearly at 12 mW/°C to 200 mW
DEVICE DISSIPATION PER OUTPUT TRANSISTOR	
FOR T <sub>A</sub> = FULL PACKAGE-TEMPERATURE RANGE (ALL PACKAGE TYPES)	.100 mW
INPUT VOLTAGE RANGE, ALL INPUTS	-0.5 to V <sub>DD</sub> + 0.5 V
LEAD TEMPERATURE (DURING SOLDERING):	
At distance 1/16 ± 1/32 inch (1.59 ± 0.79 mm) from case for 10 s max.	+265°C

### STATIC ELECTRICAL CHARACTERISTICS

Characteristic	Conditions			Limits at Indicated Temperatures (°C)								Units		
				D, F, K, H Packages				E Package						
	V <sub>O</sub> (V)	V <sub>IN</sub> (V)	V <sub>DD</sub> (V)	-55	+25	+125	-40	+25	+85	Typ.	Limit		Typ.	Limit
Quiescent Device Current, I <sub>L</sub> Max.	-	-	5	5	0.3	5	300	50	0.5	50	700			
	-	-	10	10	0.5	10	600	500	1	100	1400			
	-	-	15	50	1	50	2000	500	5	500	5000			
Output Voltage: Low-Level, V <sub>OL</sub>	-	0.5	5	0 Typ.; 0.05 Max.										V
	-	0.10	10	0 Typ.; 0.05 Max.										
High Level, V <sub>OH</sub>	-	0.5	5	4.95 Min.; 5 Typ.										V
	-	0.10	10	9.95 Min.; 10 Typ.										
Noise Immunity: Inputs Low, V <sub>NL</sub>	4.2	-	5	1.5 Min.; 2.25 Typ.										V
	9	-	10	3 Min.; 4.5 Typ.										
Inputs High, V <sub>NH</sub>	0.8	-	5	1.5 Min.; 2.25 Typ.										V
	1	-	10	3 Min.; 4.5 Typ.										
Noise Margin: Inputs Low, V <sub>NML</sub>	4.5	-	5	1 Min.										V
	9	-	10	1 Min.										
Inputs High, V <sub>NMH</sub>	0.5	-	5	1 Min.										V
	1	-	10	1 Min.										
Output Drive Current: n-Channel (Sink), I <sub>DN</sub> Min.	* 0.5	-	5	0.31	0.5	0.25	0.175	0.155	0.5	0.13	0.105	mA		
	* 0.5	-	10	0.93	1.5	0.75	0.53	0.6	1.5	0.5	0.4			
	▲ 3	-	5	0.012	0.2	0.01	0.007	0.009	0.2	0.007	0.005			
	▲ 3	-	10	0.31	0.5	0.25	0.175	0.24	0.5	0.2	0.16			
	* 4.5	-	5	-0.31	-0.5	-0.25	-0.175	-0.155	-0.5	-0.13	-0.105			
	* 9.5	-	10	-0.93	-1.5	-0.75	-0.53	-0.6	-1.5	-0.5	-0.4			
p-Channel (Source), I <sub>DP</sub> Min.	▲ 2	-	5	-0.012	-0.2	-0.01	-0.007	-0.008	-0.2	-0.007	-0.005	mA		
	▲ 3	-	10	-0.185	-0.3	-0.15	-0.105	-0.12	-0.3	-0.1	-0.08			
	▲ 7	-	10	-0.185	-0.3	-0.15	-0.105	-0.12	-0.3	-0.1	-0.08			
Input Leakage Current, I <sub>L</sub> , I <sub>IH</sub> Max.	Any Input		15	±10 <sup>-5</sup> Typ.; ±1 Max.										μA

\* Carry Output    ▲ Sum Output

**RECOMMENDED OPERATING CONDITIONS**  
For maximum reliability, nominal operating conditions should be selected so that operation is always within the following ranges.

Characteristic	Min.	Max.	Units
Supply-Voltage Range (T <sub>A</sub> = Full Package-Temp. Range)	3	12	V

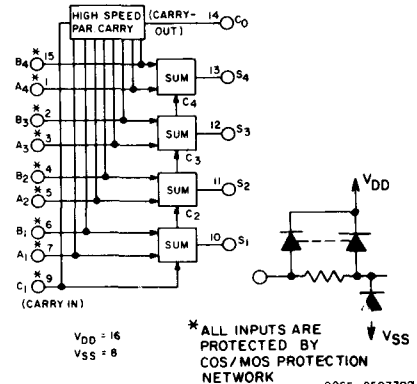

Fig. 1 - CD4008A logic diagram.

### TRUTH TABLE

A <sub>1</sub>	B <sub>1</sub>	C <sub>1</sub>	C <sub>0</sub>	SUM
0	0	0	0	0
1	0	0	0	1
0	1	0	0	1
1	1	0	1	0
0	0	1	0	1
1	0	1	1	0
0	1	1	1	0
1	1	1	1	1

# CD4008A Types

DYNAMIC ELECTRICAL CHARACTERISTICS at  $T_A = 25^\circ\text{C}$ ; Input  $t_r, t_f = 20\text{ ns}$ ,  $C_L = 15\text{ pF}$ ,  $R_L = 200\text{ K}\Omega$

CHARACTERISTIC	V <sub>DD</sub> (V)	LIMITS				UNITS
		D, F, K, H Packages		E Package		
		Typ.	Max.	Typ.	Max.	
Propagation Delay Time: $t_{PHL}, t_{PLH}$ Sum In to Sum Out	5	900	1300	900	2000	ns
	10	325	500	325	650	
Carry In to Sum Out	5	900	1300	900	2000	ns
	10	325	500	325	650	
Sum In to Carry Out	5	320	600	320	800	ns
	10	120	200	120	240	
Carry In to Carry Out	5	100	175	100	200	ns
	10	45	75	45	90	
Transition Time: $t_{THL}, t_{TLH}$ At Sum Outputs	5	1250	2200	1250	2900	ns
	10	550	900	550	1100	
At Carry Output	5	125	225	125	290	ns
	10	45	75	45	90	
Input Capacitance, $C_I$ (Any Input)	—	10	—	10	—	pF

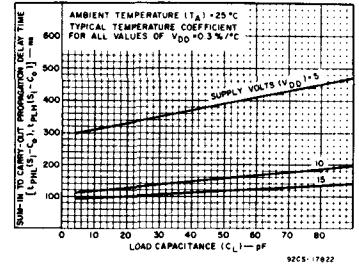

Fig. 2 - Typical sum-in to carry-out propagation delay time vs.  $C_L$ .

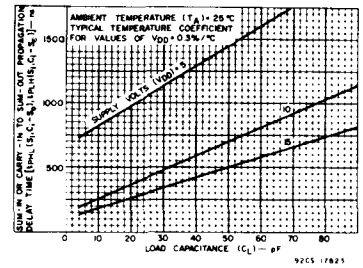

Fig. 3 - Typical sum-in or carry-in to sum-out propagation delay time vs.  $C_L$ .

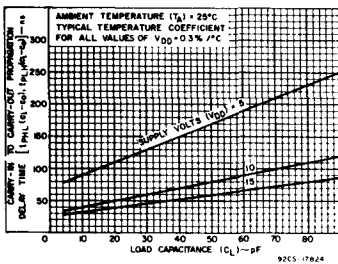

Fig. 4 - Typical carry-in to carry-out propagation delay time vs.  $C_L$ .

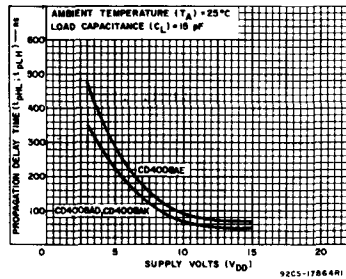

Fig. 5 - Typical maximum propagation delay time vs.  $V_{DD}$  for carry-in to carry-out.

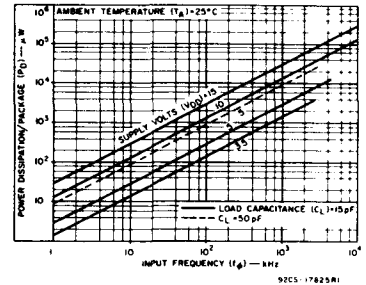

Fig. 6 - Typical dissipation characteristics.

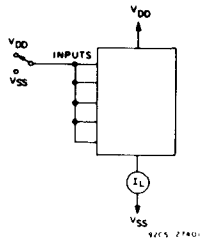

Fig. 7 - Quiescent device current test circuit.

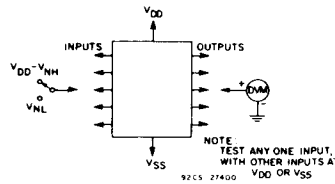

Fig. 8 - Noise immunity test circuit.

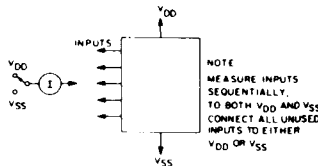

Fig. 9 - Input leakage current test circuit.

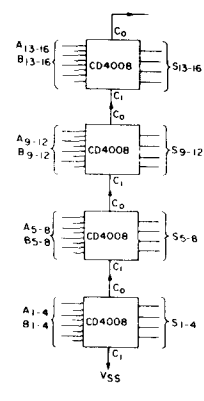

Fig. 10 - Typical connection for a 16-bit adder.

# CD4009A, CD4010A Types

## CMOS Hex Buffers/Converters

Inverting Type: CD4009A  
Non-Inverting Type: CD4010A

The RCA-CD4009A and CD4010A Hex Buffer/Converters may be used as COS/MOS to TTL or DTL logic-level converters or CMOS high sink-current drivers.

The CD4049A and CD4050A are preferred hex buffer replacements for the CD4009A and CD4010A, respectively, in all applications except multiplexers. For applications not requiring high sink current or voltage conversion, the CD4069B Hex Inverter is recommended.

These types are supplied in 16-lead hermetic dual-in-line ceramic packages (D and F suffixes), 16-lead dual-in-line plastic package (E suffix), 16-lead ceramic flat packages (K suffix), and in chip form (H suffix).

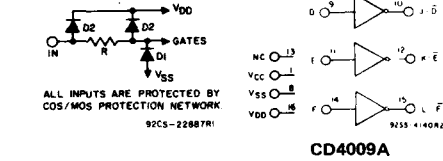

### Features:

- Quiescent current specified to 15 V
- Maximum input leakage of 1  $\mu$ A at 15 V (full package-temperature range)
- High sink current for driving 2 TTL loads
- High-to-low level logic conversion

### Applications:

- CMOS to DTL/TTL hex converter
- CMOS current "sink" or "source" driver
- CMOS high-to-low logic-level converter
- Multiplexer — 1 to 6 or 6 to 1

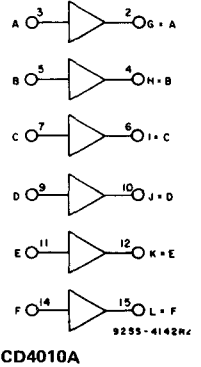

Fig. 1 — Logic diagrams.

RECOMMENDED OPERATING CONDITIONS at  $T_A = 25^\circ\text{C}$ , Except as Noted.  
For maximum reliability, nominal operating conditions should be selected so that operation is always within the following ranges:

CHARACTERISTIC	LIMITS		UNITS
	Min.	Max.	
Supply-Voltage Range (For $T_A =$ Full Package-Temperature Range : $V_{DD}, V_{CC}$ )	3	12	V
Input Voltage Range ( $V_I$ )	$V_{CC}^*$	12	V

\* The CD4009 and CD4010 have high-to-low level voltage conversion capability but not low-to-high level, therefore it is recommended that  $V_{DD} \geq V_I \geq V_{CC}$ .

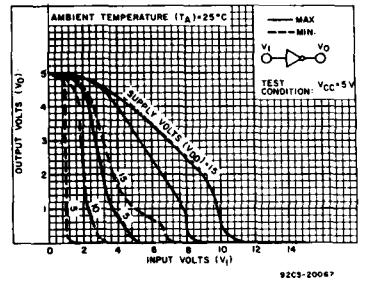

Fig. 2 — Minimum & maximum voltage transfer characteristics — CD4009A.

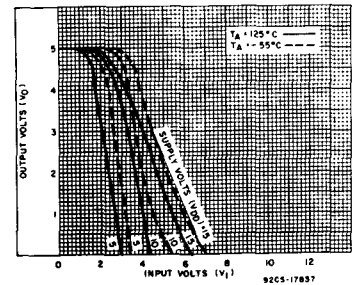

Fig. 3 — Typical voltage transfer characteristics as function of temp. — CD4009A.

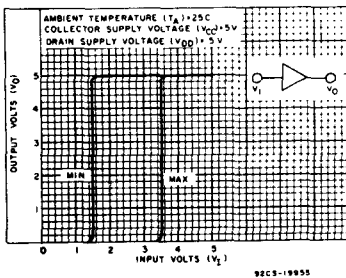

Fig. 4 — Minimum & maximum voltage transfer characteristics ( $V_{DD} = 5$ ) — CD4010A.

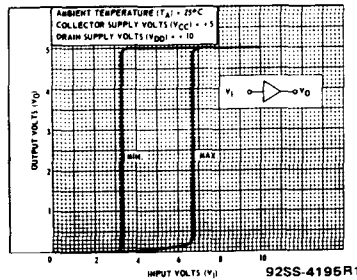

Fig. 5 — Minimum & maximum voltage transfer characteristics ( $V_{DD} = 10$ ) — CD4010A.

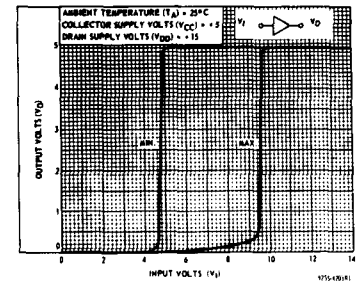

Fig. 6 — Minimum & maximum voltage transfer characteristics ( $V_{DD} = 15$ ) — CD4010A.

# CD4009A, CD4010A Types

## STATIC ELECTRICAL CHARACTERISTICS

Characteristic	Conditions			Limits at Indicated Temperatures (°C)								Units
				D, F, K, H Packages				E Package				
	VO (V)	VIN (V)	VCC* (V)	-55	+25		+125	-40	+25		+85	
Quiescent Device Current, I <sub>L</sub> Max.	-	-	5	0.3	0.01	0.3	20	3	0.03	3	42	
	-	-	10	0.5	0.01	0.5	30	5	0.05	5	70	
	-	-	15	10	0.02	10	100	50	0.5	50	500	
Output Voltage: Low-Level, VOL	-	0.5	5	0 Typ.; 0.05 Max.								V
	-	0,10	10	0 Typ.; 0.05 Max.								
High Level VOH	-	0.5	5	4.95 Min.; 5 Typ.								V
	-	0,10	10	9.95 Min.; 10 Typ.								
Noise Immunity: Inputs Low, VNL	3.6	-	5	1.5 Min.; 2.25 Typ.								V
	7.2	-	10	3 Min.; 4.5 Typ.								
Inputs High VNH	1.4	-	5	1.5 Min.; 2.25 Typ.								V
	2.8	-	10	3 Min.; 4.5 Typ.								
Inputs Low, VNL	3.6	-	5	1 Min.; 1.5 Typ.								V
	7.2	-	10	2 Min.; 3 Typ.								
Noise Margin: Inputs Low, VNML	4.5	-	5	1 Min.								V
	9	-	10	1 Min.								
Inputs High, VNMH	0.5	-	5	1 Min.								V
	1	-	10	1 Min.								
Output Drive Current: N-Channel (Sink), I <sub>D</sub> N Min.	0.4	-	5	3.75	4	3	2.1	3.6	4	3	2.4	mA
	0.5	-	10	10	10	8	5.6	9.6	10	8	6.4	
P-Channel (Source), I <sub>D</sub> P Min.	4.6	-	5	-0.31	-0.5	-0.25	-0.175	-0.3	-0.5	-0.25	-0.2	mA
	2.5	-	5	-1.85	-1.75	-1.25	-0.9	-1.5	-1.75	-1.25	-1	
9.5	-	10	-0.9	-0.8	-0.6	-0.4	-0.72	-0.8	-0.6	-0.48		
Input Leakage Current, I <sub>IL</sub> , I <sub>IH</sub>	Any Input		15	±10 <sup>-5</sup> Typ.; ±1 Max.								μA

\* V<sub>CC</sub> = V<sub>DD</sub>

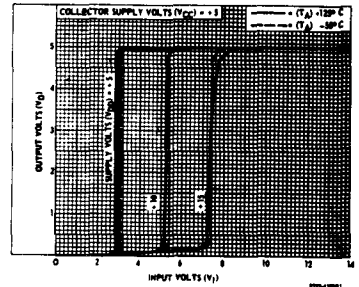

Fig. 7 - Typical voltage transfer characteristics as a function of temperature - CD4010A.

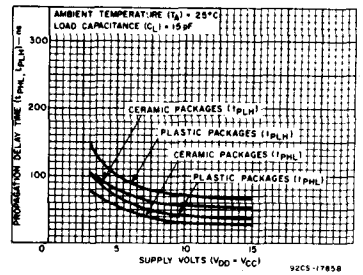

Fig. 8 - Maximum propagation delay time vs. V<sub>DD</sub> - CD4010A.

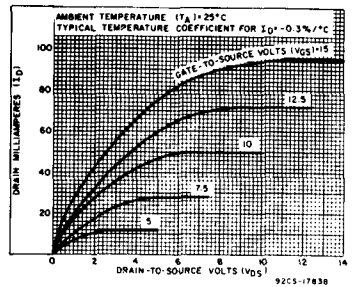

Fig. 9 - Typical n-channel drain characteristics.

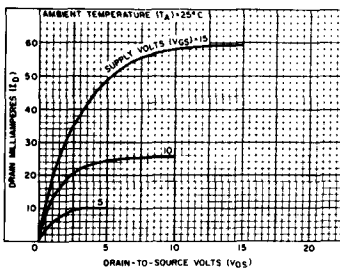

Fig. 10 - Minimum n-channel drain characteristics.

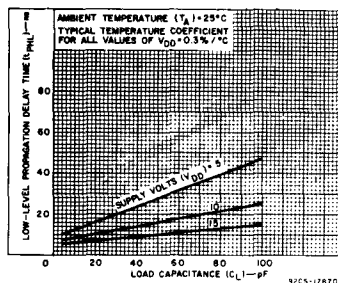

Fig. 11 - Typical high-to-low level propagation delay time vs. C<sub>L</sub>.

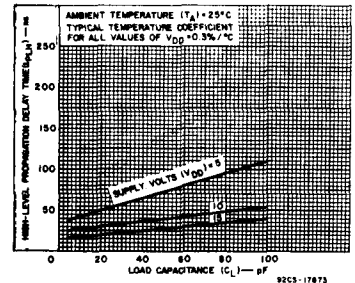

Fig. 12 - Typical low-to-high level propagation delay time vs. C<sub>L</sub>.

# CD4009A, CD4010A Types

DYNAMIC ELECTRICAL CHARACTERISTICS at  $T_A = 25^\circ\text{C}$ ; Input  $t_r, t_f = 20 \text{ ns}$ ,  $C_L = 15 \text{ pF}$ ,  $R_L = 200 \text{ K}\Omega$

CHARACTERISTIC	CONDITION			LIMIT		UNITS
	V <sub>DD</sub> (V)	V <sub>I</sub> (V)	V <sub>CC</sub> (V)	Typ.	Max.	
<i>D, F, K, H Packages</i>						
Propagation Delay Time: Low-to-High, $t_{PLH}$	5	5	5	50	80	ns
	10	10	10	25	55	
	10	10	5	15	30	
High-to-Low, $t_{PHL}$	5	5	5	15	55	ns
	10	10	10	10	30	
	10	10	5	10	25	
Transition Time: Low-to-High, $t_{TLH}$	5	5	5	80	125	ns
	10	10	10	50	100	
High-to-Low, $t_{THL}$	5	5	5	20	45	ns
	10	10	10	16	40	
Input Capacitance, $C_i$ CD4009A CD4010A	—	—	—	15	—	pF
	—	—	—	5	—	
<i>E Package</i>						
Propagation Delay Time: Low-to-high, $t_{PLH}$	5	5	5	50	100	ns
	10	10	10	25	70	
	10	10	5	15	40	
High-to-Low, $t_{PHL}$	5	5	5	15	70	ns
	10	10	10	10	40	
	10	10	5	10	35	
Transition Time: Low-to-High, $t_{PLH}$	5	5	5	80	160	ns
	10	10	10	50	120	
High-to-Low, $t_{THL}$	5	5	5	20	60	ns
	10	10	10	16	50	
Input Capacitance, $C_i$ CD4009A CD4010A	—	—	—	15	—	pF
	—	—	—	5	—	

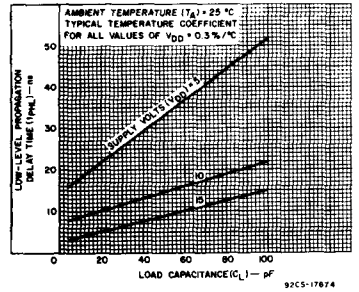

Fig. 13 — Typical high-to-low level propagation delay time vs.  $C_L$  (driving TTL, DTL).

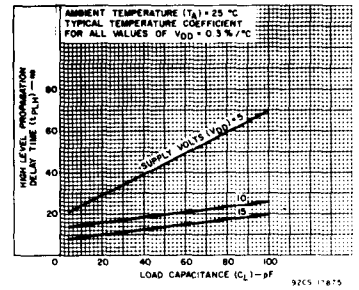

Fig. 14 — Typical low-to-high level propagation delay time vs.  $C_L$  (driving TTL, DTL)

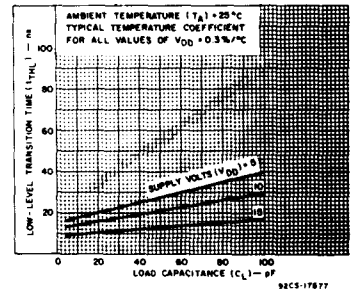

Fig. 15 — Typical high-to-low level transition time vs.  $C_L$ .

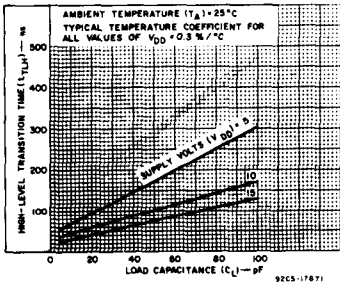

Fig. 16 — Typical low-to-high level transition time vs.  $C_L$ .

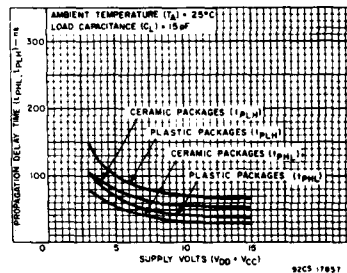

Fig. 17 — Maximum propagation delay time vs.  $V_{DD}$  — CD4009A.

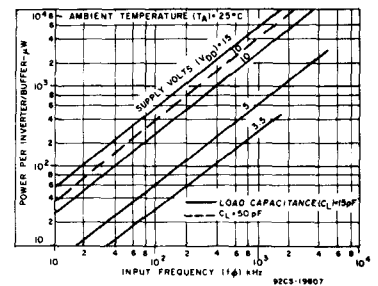

Fig. 18 — Typical dissipation characteristics.

# CD4011A, CD4012A, CD4023A Types

## CMOS NAND Gates

Quad 2 Input – CD4011A  
Dual 4 Input – CD4012A  
Triple 3 Input – CD4023A

The RCA-CD4011A, CD4012A, and CD4023A NAND gates provide the system designer with direct implementation of the NAND function and supplement the existing family of CMOS gates.

These types are supplied in 14-lead hermetic dual-in-line ceramic packages (D and F suffixes), 14-lead dual-in-line plastic packages (E suffix), 14-lead ceramic flat packages (K suffix), and in chip form (H suffix).

### Features:

- Quiescent current specified to 15 V
- Maximum input leakage of 1  $\mu$ A at 15 V (full package-temperature range)
- 1-V noise margin (full package-temperature range)

### RECOMMENDED OPERATING CONDITIONS

For maximum reliability, nominal operating conditions should be selected so that operation is always within the following ranges:

Characteristic	Min.	Max.	Units
Supply Voltage Range (over full package temperature range)	3	12	V

### MAXIMUM RATINGS, Absolute-Maximum Values:

- STORAGE-TEMPERATURE RANGE ( $T_{stg}$ ) ..... -65 to +150°C
- OPERATING-TEMPERATURE RANGE ( $T_A$ ):
- PACKAGE TYPES D, F, K, H ..... -55 to +125°C
- PACKAGE TYPE E ..... -40 to +85°C
- DC SUPPLY-VOLTAGE RANGE, ( $V_{DD}$ )
- (Voltages referenced to  $V_{SS}$  Terminal): ..... -0.5 to +15 V
- POWER DISSIPATION PER PACKAGE ( $P_D$ ):
- FOR  $T_A = -40$  to +60°C (PACKAGE TYPE E) ..... 500 mW
- FOR  $T_A = +60$  to +85°C (PACKAGE TYPE E) ..... Derate Linearly at 12 mW/°C to 200 mW
- FOR  $T_A = -55$  to +100°C (PACKAGE TYPES D, F, K) ..... 500 mW
- FOR  $T_A = +100$  to +125°C (PACKAGE TYPES D, F, K) ..... Derate Linearly at 12 mW/°C to 200 mW
- DEVICE DISSIPATION PER OUTPUT TRANSISTOR
- FOR  $T_A =$  FULL PACKAGE-TEMPERATURE RANGE (ALL PACKAGE TYPES) ..... 100 mW
- INPUT VOLTAGE RANGE, ALL INPUTS ..... -0.5 to  $V_{DD} + 0.5$  V
- LEAD TEMPERATURE (DURING SOLDERING):
- At distance 1/16  $\pm$  1/32 inch (1.59  $\pm$  0.79 mm) from case for 10 s max ..... +265°C

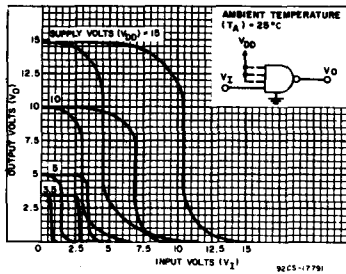

Fig. 2 - Minimum & maximum voltage transfer characteristics.

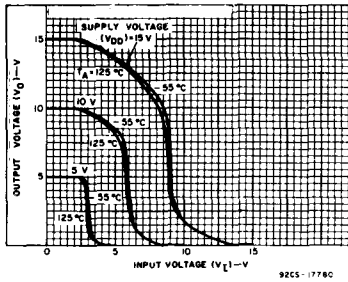

Fig. 3 - Typical voltage transfer characteristics as a function of temperature.

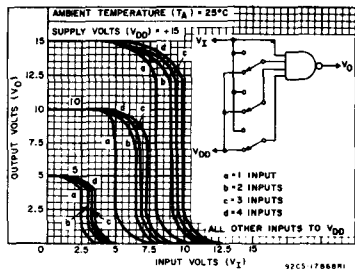

Fig. 4 - Typical multiple input switching transfer characteristics for CD4012A.

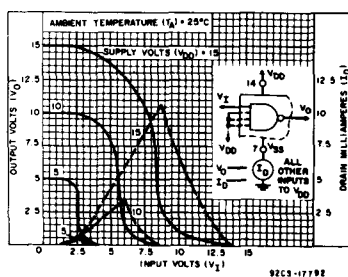
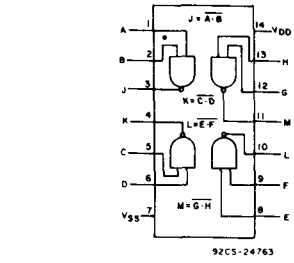
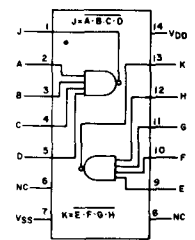

Fig. 5 - Typical current & voltage transfer characteristics.



CD4011A



CD4012A

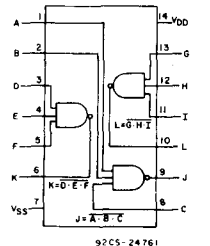

CD4023AH

Fig. 1 - Functional diagrams.

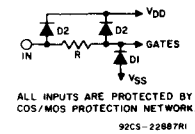

ALL INPUTS ARE PROTECTED BY COS/MOS PROTECTION NETWORK

# CD4011A, CD4012A, CD4023A Types

## STATIC ELECTRICAL CHARACTERISTICS

Characteristic	Conditions			Limits at Indicated Temperatures (°C)									Units
				D, F, K, H Packages						E Package			
				-55	+25		+125	-40	+25		+85		
V <sub>O</sub> (V)	V <sub>IN</sub> (V)	V <sub>DD</sub> (V)	Typ.	Limit	Typ.	Limit	Typ.	Limit	Typ.	Limit			
Quiescent Device Current, I <sub>Q</sub> Max.	-	-	5	0.05	0.001	0.05	3	0.5	0.005	0.5	15	μA	
	-	-	10	0.1	0.001	0.1	6	5	0.005	5	30		
	-	-	15	2	0.02	2	40	50	0.5	50	500		
Output Voltage: Low-Level V <sub>OL</sub>	-	0.5	5	0 Typ.; 0.05 Max.									V
	-	0.10	10	0 Typ.; 0.05 Max.									
High Level, V <sub>OH</sub>	-	0.5	5	4.95 Min.; 5 Typ.									V
	-	0.10	10	9.95 Min.; 10 Typ.									
Noise Immunity: Inputs Low, V <sub>NL</sub>	3.6	-	5	1.5 Min.; 2.25 Typ.									V
	7.2	-	10	3 Min.; 4.5 Typ.									
Inputs High, V <sub>NH</sub>	1.4	-	5	1.5 Min.; 2.25 Typ.;									V
	2.8	-	10	3 Min.; 4.5 Typ.									
Noise Margin: Inputs Low, V <sub>NML</sub>	4.5	-	5	1 Min.									V
	9	-	10	1 Min.									
Inputs High, V <sub>NMH</sub>	0.5	-	5	1 Min.									V
	1	-	10	1 Min.									
Output Drive Current: N-Channel (Sink) I <sub>DN</sub> Min.	0.5	-	5	0.31	0.5	0.25	0.175	0.145	0.5	0.12	0.095	mA	
			10	0.62	0.6	0.5	0.35	0.3	0.6	0.25	0.2		
			15	0.93	0.9	0.5	0.52	0.45	0.9	0.35	0.3		
CD4011A CD4023A	0.5	-	5	0.15	0.25	0.12	0.085	0.072	0.25	0.06	0.05	mA	
			10	0.31	0.6	0.25	0.175	0.155	0.6	0.13	0.105		
CD4012A	0.5	-	5	0.31	0.6	0.25	0.175	0.155	0.6	0.13	0.105	mA	
			10	0.62	1.2	0.5	0.35	0.3	1.2	0.25	0.2		
P-Channel (Source), I <sub>DP</sub> Min.	4.5	-	5	-0.31	-0.5	-0.25	-0.175	-0.145	-0.5	-0.12	-0.095	mA	
			10	-0.62	-1.2	-0.5	-0.35	-0.3	-1.2	-0.25	-0.2		
All Types	9.5	-	10	-0.75	-1.2	-0.6	-0.4	-0.35	-1.2	-0.3	-0.24	mA	
			15	-1.1	-1.8	-0.9	-0.6	-0.45	-1.8	-0.4	-0.3		
Input Leakage Current, I <sub>IL</sub> , I <sub>IH</sub>	Any Input	-	15	±10 <sup>-5</sup> Typ.; ±1 Max.									μA

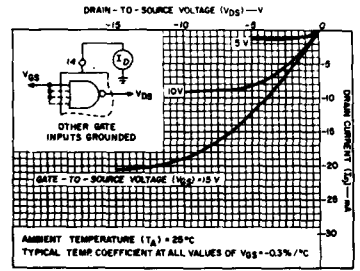

Fig. 7 — Typical p-channel drain characteristics.

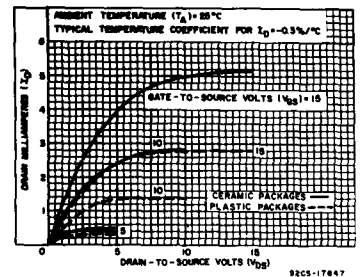

Fig. 8 — Minimum n-channel drain characteristics — CD4011A & CD4023A.

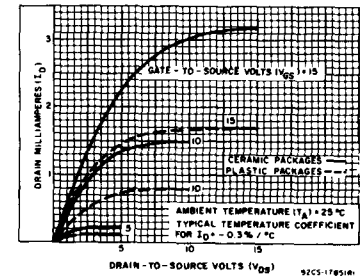

Fig. 9 — Minimum n-channel drain characteristics.

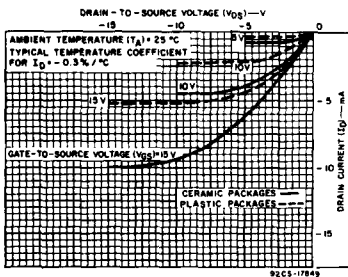

Fig. 10 — Minimum p-channel drain characteristics.

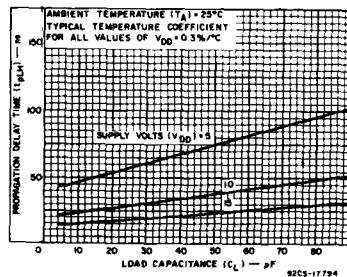

Fig. 11 — Typical low-to-high level propagation delay time vs. C<sub>L</sub>.

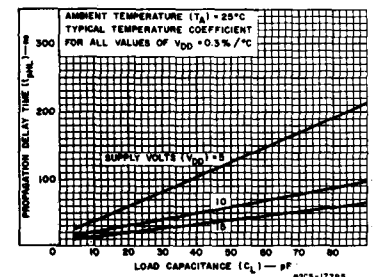

Fig. 12 — Typical high-to-low level propagation delay time vs. C<sub>L</sub> — CD4011A, & CD4023A.

# CD4011A, CD4012A, CD4023A Types

DYNAMIC ELECTRICAL CHARACTERISTICS at  $T_A = 25^\circ\text{C}$ ,  $C_L = 15\text{ pF}$ , Input  $t_r, t_f = 20\text{ ns}$ ,  $R_L = 200\text{ k}\Omega$

CHARACTERISTICS	TEST CONDITIONS	LIMITS				UNITS	
		VDD (V)	D, F, K, H Packages		E Package		
			Typ.	Max.	Typ.		Max.
Propagation Delay Time: Low-to-High Level, $t_{PLH}$		5	50	75	50	100	ns
		10	25	40	25	50	
High-to-Low Level, $t_{PHL}$ CD4011A and CD4023A		5	50	75	50	100	ns
		10	25	40	25	50	
CD4012A		5	100	150	100	200	ns
		10	50	75	50	100	
Transition Time: Low-to-High Level, $t_{TLH}$		5	75	100	75	125	ns
		10	40	60	40	75	
High-to-Low Level, $t_{THL}$ CD4011A and CD4023A		5	75	125	75	150	ns
		10	50	75	50	100	
CD4012A		5	250	375	250	500	ns
		10	125	200	125	250	
Input Capacitance, $C_i$	Any Input	5	-	5	-	pF	

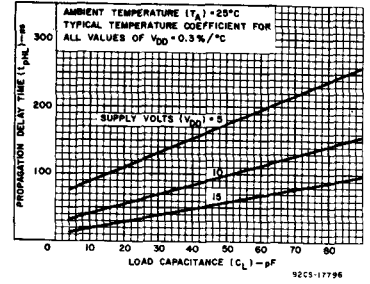

Fig. 13 - Typical high-to-low level propagation delay time vs.  $C_L$  - CD4012A.

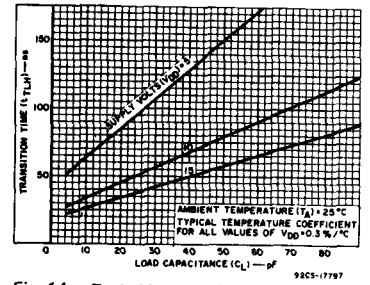

Fig. 14 - Typical low-to-high transition time vs.  $C_L$ .

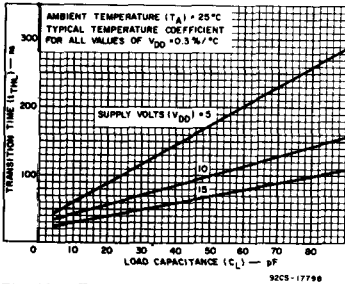

Fig. 15 - Typical high-to-low level transition time vs.  $C_L$  - CD4011A & CD4023A.

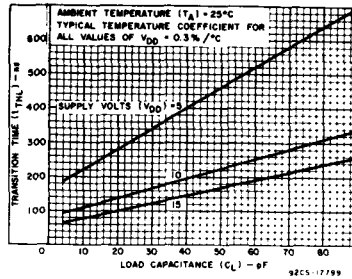

Fig. 16 - Typical high-to-low level transition time vs.  $C_L$  - CD4012A.

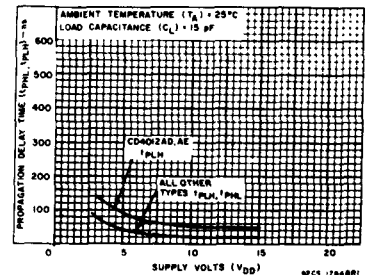

Fig. 17 - Minimum propagation delay time vs.  $V_{DD}$ .

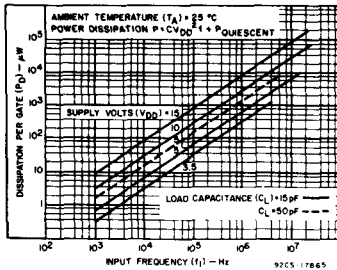

Fig. 18 - Typical dissipation characteristics.

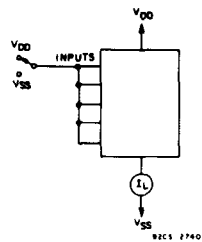

Fig. 19 - Quiescent device current test circuit.

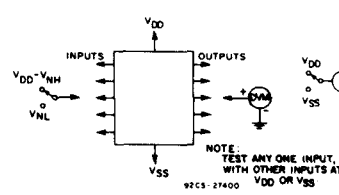

Fig. 20 - Noise immunity test circuit.

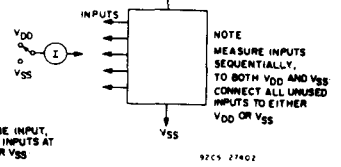

Fig. 21 - Input leakage current test circuit.



## Dual 'D'-Type Flip-Flop

The RCA-CD4013A consists of two identical, independent data-type flip-flops. Each flip-flop has independent data, set, reset, and clock inputs, and Q and  $\bar{Q}$  outputs. These devices can be used for shift register applications, and by connecting  $\bar{Q}$  output to the data input, for counter and toggle applications. The logic level present at the D input is transferred to the Q output during the positive-going transition of the clock pulse.

Setting or resetting is independent of the clock and is accomplished by a high level on the set (with low-level on reset) or reset (with low-level on set) line, respectively. These types are supplied in 14-lead hermetic dual-in-line ceramic packages (D and F suffixes), 14-lead dual-in-line plastic packages (E suffix), 14-lead ceramic flat packages (K suffix), and in chip form (H suffix).

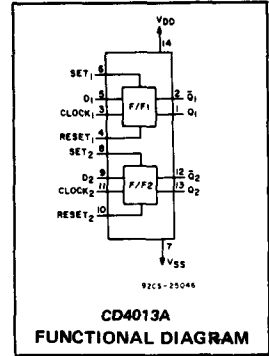

**MAXIMUM RATINGS, Absolute-Maximum Values:**

STORAGE-TEMPERATURE RANGE ( $T_{stg}$ )	-65 to +150°C
OPERATING-TEMPERATURE RANGE ( $T_A$ ):	
PACKAGE TYPES D, F, K, H	-55 to +125°C
PACKAGE TYPE E	-40 to +85°C
DC SUPPLY-VOLTAGE RANGE, ( $V_{DD}$ ) (Voltages referenced to $V_{SS}$ Terminal)	-0.5 to +15 V
POWER DISSIPATION PER PACKAGE ( $P_D$ ):	
FOR $T_A = -40$ to +60°C (PACKAGE TYPE E)	500 mW
FOR $T_A = +60$ to +85°C (PACKAGE TYPE E)	Derate Linearly at 12 mW/°C to 200 mW
FOR $T_A = -55$ to +100°C (PACKAGE TYPES D, F, K)	500 mW
FOR $T_A = +100$ to +125°C (PACKAGE TYPES D, F, K)	Derate Linearly at 12 mW/°C to 200 mW
DEVICE DISSIPATION PER OUTPUT TRANSISTOR	
FOR $T_A =$ FULL PACKAGE-TEMPERATURE RANGE (ALL PACKAGE TYPES)	100 mW
INPUT VOLTAGE RANGE, ALL INPUTS	-0.5 to $V_{DD} + 0.5$ V
LEAD TEMPERATURE (DURING SOLDERING):	
At distance 1/16 ± 1/32 inch (1.59 ± 0.79 mm) from case for 10 s max.	+265°C

**Features:**

- Set-Reset capability
- Static flip-flop operation — retains state indefinitely with clock level either "high" or "low"
- Medium-speed operation — 10 MHz (typ.) clock toggle rate at 10 V
- Quiescent current specified to 15 V
- Maximum input leakage of 1  $\mu$ A at 15 V (full package-temperature range)
- 1-V noise margin (full package-temperature range)

**Applications:**

- Registers, counters, control circuits

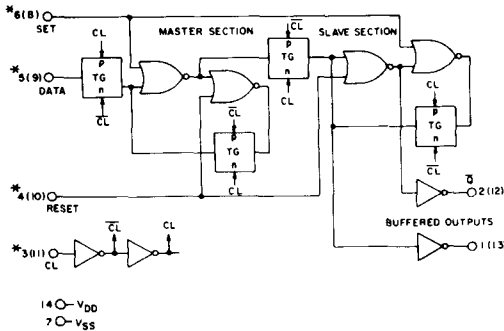
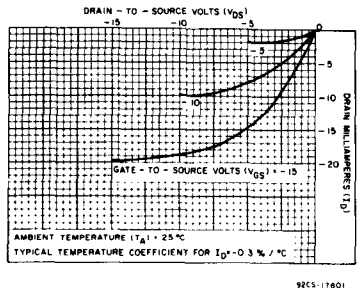
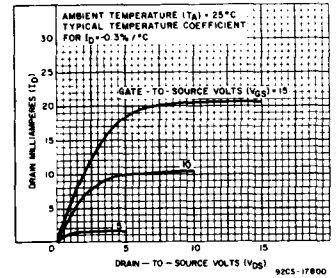

Fig. 1 — Logic diagram and truth table for CD4013A (one of two identical flip flops).



# CD4013A Types

**RECOMMENDED OPERATING CONDITIONS at  $T_A = 25^\circ\text{C}$ , Except as Noted:**  
 For maximum reliability, nominal operating conditions should be selected so that operation is always within the following ranges -

CHARACTERISTIC	VDD (V)	LIMITS				UNITS
		D,F,K,H Packages		E Package		
		Min.	Max.	Min.	Max.	
Supply Voltage Range (For $T_A =$ Full Package Temperature Range)	-	3	12	3	12	V
Data Setup Time $t_S$	5 10	40 20	- -	50 25	- -	ns
Clock Pulse Width $t_W$	5 10	200 80	- -	500 100	- -	ns
Clock Input Frequency $f_{CL}$	5 10	dc	2.5 7	dc	1 5	MHz
Clock Rise or Fall Time $t_{rCL}, t_{fCL}$	5 10	- -	15 5	- -	15 5	$\mu\text{s}$
Set or Reset Pulse Width	5 10	250 100	- -	500 125	- -	ns

\* If more than one unit is cascaded in a parallel clocked operation,  $t_{rCL}$  should be made less than or equal to the sum of the fixed propagation delay time at 15 pF and the transition time of the output driving stage for the estimated capacitive load.

**DYNAMIC ELECTRICAL CHARACTERISTICS at  $T_A = 25^\circ\text{C}$ , Input  $t_r, t_f = 20 \text{ ns}$ ,  $C_L = 15 \text{ pF}$ ,  $R_L = 200 \text{ k}\Omega$**

CHARACTERISTIC	VDD (V)	LIMITS						UNITS
		D,F,K,H Packages			E Package			
		Min.	Typ.	Max.	Min.	Typ.	Max.	
Propagation Delay Time: Clock to Q or $\bar{Q}$ Outputs $t_{PHL}, t_{PLH}$	5	-	150	300	-	150	350	ns
	10	-	75	110	-	75	125	
Set to Q or Reset to $\bar{Q}$ $t_{PLH}$	5	-	175	300	-	175	350	ns
	10	-	75	110	-	75	125	
Set to $\bar{Q}$ or Reset to Q $t_{PHL}$	5	-	175	300	-	175	350	ns
	10	-	75	110	-	75	125	
Transition Time, $t_{THL}, t_{TLH}$	5	-	75	125	-	75	150	ns
	10	-	50	70	-	50	75	
Maximum Clock Input Frequency, $f_{CL}$	5 10	2.5 7	4 10	- -	1 5	4 10	- -	MHz
Minimum Clock Pulse Width, $t_W$	5 10	- -	125 50	200 80	- -	125 50	500 100	ns
Minimum Set or Reset Pulse Width, $t_W$	5 10	- -	125 50	250 100	- -	125 50	500 125	ns
Minimum Data Setup Time, $t_S$	5 10	- -	20 10	40 20	- -	20 10	50 25	ns
Clock Rise or Fall Time $t_{rCL}, t_{fCL}$	5 10	- -	- -	15 5	- -	- -	15 5	$\mu\text{s}$
Average Input Capacitance, $C_i$	Any Input	-	5	-	-	5	-	pF

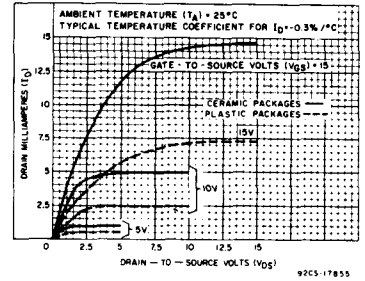

Fig. 4 - Minimum n-channel drain characteristics.

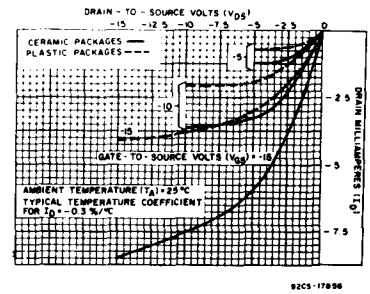

Fig. 5 - Minimum p-channel drain characteristics.

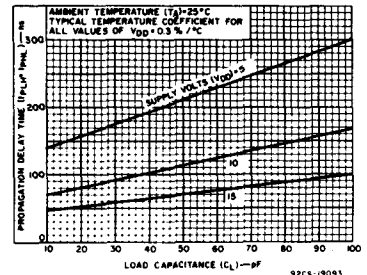

Fig. 6 - Typical propagation delay time vs.  $C_L$ .

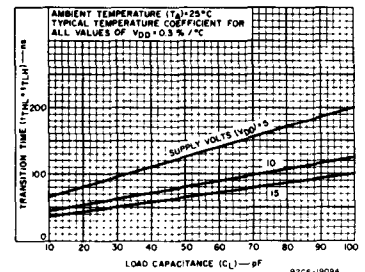

Fig. 7 - Typical transition time vs.  $C_L$ .

# CD4013A Types

## STATIC ELECTRICAL CHARACTERISTICS

Characteristic	Conditions			Limits at Indicated Temperatures (°C)								Units
				D, F, K, H Packages				E Package				
				V <sub>O</sub> (V)	V <sub>IN</sub> (V)	V <sub>DD</sub> (V)	-55	+25		+125	-40	
Quiescent Device Current, I <sub>L</sub> Max.	-	-	5	1	0.005	1	60	10	0.01	10	140	μA
	-	-	10	2	0.005	2	120	20	0.02	20	280	
	-	-	15	25	0.5	25	1000	250	2.5	250	2500	
Output Voltage: Low-Level, V <sub>OL</sub>	-	0.5	5	0 Typ.; 0.05 Max.								V
	-	0.10	10	0 Typ.; 0.05 Max.								
	-	0.5	5	5 Typ.; 4.95 Min.								
High-Level, V <sub>OH</sub>	-	0.10	10	10 Typ.; 9.95 Min.								
	-	0.10	10	10 Typ.; 9.95 Min.								
Noise Immunity: Inputs Low, V <sub>NL</sub>	4.2	-	5	2.25 Typ.; 1.5 Min.								V
	9	-	10	4.5 Typ.; 3 Min.								
	0.8	-	5	2.25 Typ.; 1.5 Min.								
Inputs High, V <sub>NH</sub>	1	-	10	4.5 Typ.; 3 Min.								
	1	-	10	4.5 Typ.; 3 Min.								
Noise Margin: Inputs Low, V <sub>NML</sub>	4.5	-	5	1 Min.								V
	9	-	10	1 Min.								
	0.5	-	5	1 Min.								
Inputs High, V <sub>NMH</sub>	1	-	10	1 Min.								
	1	-	10	1 Min.								
Output Drive Current: N-Channel (Sink), I <sub>DN</sub> Min.	0.5	-	5	0.65	1	0.5	0.35	0.35	1	0.3	0.24	mA
	0.5	-	10	1.25	2.5	1	0.75	0.72	2.5	0.6	0.5	
P-Channel (Source), I <sub>DP</sub> Min.	4.5	-	5	-0.31	-0.5	-0.25	-0.175	-0.17	-0.5	-0.14	-0.12	mA
	9.5	-	10	-0.8	-1.3	-0.65	-0.45	-0.4	-1.3	-0.33	-0.27	
Input Leakage Current, I <sub>IL</sub> , I <sub>IH</sub>	Any Input		15	±10 <sup>-5</sup> Typ.; ±1 Max.								μA

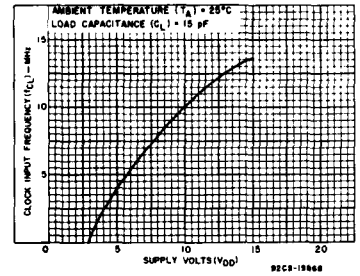

Fig. 8 - Typical maximum clock input frequency vs. V<sub>DD</sub>.

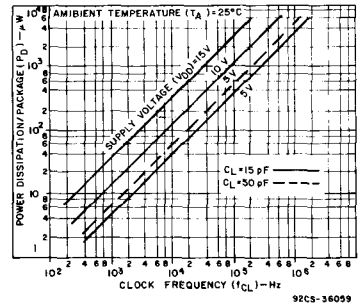

Fig. 9 - Typical dissipation characteristics.

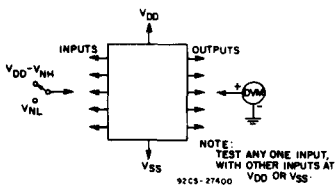

Fig. 10 - Noise immunity test circuit.

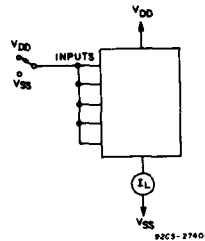

Fig. 12 - Quiescent device-current test circuit.

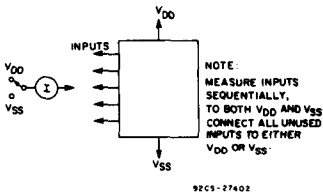

Fig. 11 - Input leakage test circuit.

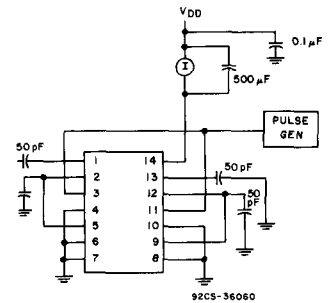

Fig. 13 - Dynamic power dissipation test circuit.

# CD4014A Types

## CMOS 8-Stage Static Shift Register

Synchronous Parallel or Serial Input/Serial Output

RECOMMENDED OPERATING CONDITIONS at  $T_A = 25^\circ\text{C}$ . Except as Noted.  
For maximum reliability, nominal operating conditions should be selected so that operation is always within the following ranges:

CHARACTERISTIC	VDD (V)	LIMITS				UNITS
		D, F, K, H Packages		E Package		
		Min.	Max.	Min.	Max.	
Supply-Voltage Range (For $T_A = \text{Full Package-Temperature Range}$ )		3	12	3	12	V
Data Setup Time, $t_S$	5 10	350 80	—	500 100	—	ns
Clock Pulse Width, $t_W$	5 10	500 175	—	830 200	—	ns
Clock Input Frequency, $f_{CL}$	5 10	dc dc	1 3	dc dc	0.6 2.5	MHz
Clock Rise and Fall Time, $t_{rCL}, t_{fCL}^*$	5 10	— —	15 5	— —	15 5	$\mu\text{s}$

\* If more than one unit is cascaded  $t_{rCL}$  should be made less than or equal to the sum of the transition time and the fixed propagation delay of the output of the driving stage for the estimated capacitive load.

### STATIC ELECTRICAL CHARACTERISTICS

Characteristic	Conditions			Limits at Indicated Temperatures ( $^\circ\text{C}$ )								Units
	V <sub>O</sub> (V)	V <sub>IN</sub> (V)	V <sub>DD</sub> (V)	D, F, K, H Packages				E Package				
				-55	+25		+125	-40	+25		+85	
Quiescent Device Current $I_L$ Max.	—	—	5	5	0.5	5	300	50	0.5	50	700	$\mu\text{A}$
	—	—	10	10	1	10	600	100	1	100	1400	
	—	—	15	50	1	50	2000	500	5	500	5000	
Output Voltage: Low-Level, $V_{OL}$	—	5	5	0 Typ.; 0.05 Max.								V
	—	10	10	0 Typ.; 0.05 Max.								
High Level $V_{OH}$	—	0	5	4.95 Min.; 5 Typ.								V
	—	0	10	9.95 Min.; 10 Typ.								
Noise Immunity: Inputs Low, $V_{NL}$	4.2	—	5	1.5 Min.; 2.25 Typ.								V
	9	—	10	3 Min.; 4.5 Typ.								
Inputs High $V_{NH}$	0.8	—	5	1.5 Min.; 2.25 Typ.								V
	1	—	10	3 Min.; 4.5 Typ.								
Noise Margin: Inputs Low, $V_{NML}$	4.5	—	5	1 Min.								V
	9	—	10	1 Min.								
Inputs High, $V_{NMH}$	0.5	—	5	1 Min.								V
	1	—	10	1 Min.								
Output Drive Current: n-Channel (Sink), $I_{DN}$ Min.	0.5	—	5	0.15	0.3	0.12	0.085	0.072	0.3	0.06	0.05	mA
	0.5	—	10	0.31	0.5	0.25	0.175	0.12	0.5	0.1	0.08	
p-Channel (Source): $I_{DP}$ Min.	4.5	—	5	-0.1	-0.16	-0.08	-0.055	-0.06	-0.16	-0.05	-0.04	mA
	9.5	—	10	-0.25	-0.44	-0.20	-0.14	-0.12	-0.44	-0.1	-0.08	
Input Leakage Current, $I_{IL}, I_{IH}$	Any Input	—	15	$\pm 10^{-5}$ Typ.; $\pm 1$ Max.								$\mu\text{A}$

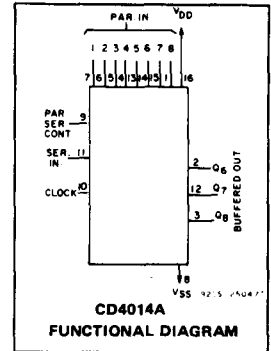

The RCA-CD4014A types are 8-stage parallel-input/serial output registers having common CLOCK and PARALLEL/SERIAL CONTROL INPUTS, a single SERIAL DATA INPUT, and individual parallel "JAM" INPUTS to each register stage. Each register stage is a D-type, master-slave flip-flop. In addition to an output from stage 8, "Q" outputs are also available from stages 6 and 7. Parallel as well as serial entry is made into the register synchronous with the positive clock line transition and under control of the PARALLEL/SERIAL CONTROL input. When the PARALLEL/SERIAL CONTROL input is low, data is serially shifted into the 8-stage register synchronously with the positive transition of the clock line. When the PARALLEL/SERIAL CONTROL input is high, data is jammed into the 8-stage register via the parallel input lines and synchronous with the positive transition of the clock line. Register expansion using multiple CD4014A packages is permitted.

These types are supplied in 16-lead hermetic dual-in-line ceramic packages (D and F suffixes), 16-lead dual-in-line plastic packages (E suffix), 16-lead ceramic flat packages (K suffix), and in chip form (H suffix).

CL $\Delta$	SER. IN	PAR SER CONTROL	PI-1	PI-n	Q <sub>1</sub> (INTERNAL)	Q <sub>n</sub>
	X	1	0	0	0	0
	X	1	1	0	1	0
	X	1	0	1	0	1
	X	1	1	1	1	1
	0	0	X	X	0	Q <sub>n-1</sub>
	1	0	X	X	1	Q <sub>n-1</sub>
	X	X	X	X	Q <sub>1</sub>	Q <sub>n</sub>

X = DON'T CARE CASE  $\Delta$  = LEVEL CHANGE  
NC = NO CHANGE

Fig. 1 - Truth table.

# CD4014A Types

## Features:

- Medium speed operation. . . . 5 MHz (typ.) clock rate at  $V_{DD} - V_{SS} = 10\text{ V}$
- Fully static operation
- 8 master-slave flip-flops plus output buffering and control gating
- Quiescent current specified to 15 V
- Maximum input leakage current of  $1\ \mu\text{A}$  at 15 V (full package-temperature range)
- 1-V noise margin (full package-temperature range)

DYNAMIC ELECTRICAL CHARACTERISTICS at  $T_A = 25^\circ\text{C}$ , Input  $t_r, t_f = 20\text{ ns}$ ,  $C_L = 15\text{ pF}$ ,  $R_L = 200\text{ k}\Omega$

CHARACTERISTIC	TEST CONDITIONS	LIMITS						UNITS
		D, F, K, H Packages			E Package			
		$V_{DD}$ (V)	Min.	Typ.	Max.	Min.	Typ.	
Propagation Delay Time; $t_{PLH}, t_{PHL}$	5	-	300	750	-	300	1000	ns
	10	-	100	225	-	100	300	
Transition Time; $t_{JHL}, t_{JLH}$	5	-	150	300	-	150	400	ns
	10	-	75	125	-	75	150	
Maximum Clock Input Frequency, $f_{CL}$	5	1	2.5	-	0.6	2.5	-	MHz
	10	3	5	-	2.5	5	-	
Minimum Clock Pulse Width, $t_W$	5	-	200	500	-	200	830	ns
	10	-	100	175	-	100	200	
Clock Rise & Fall Time; $t_r, t_f$	5	-	-	15	-	-	15	$\mu\text{s}$
	10	-	-	5	-	-	5	
Minimum Data Set Up Time, $t_S$	5	-	100	350	-	100	500	ns
	10	-	50	80	-	50	100	
Average Input Capacitance, $C_i$	Any Input	-	5	-	-	5	-	pF

\* If more than one unit is cascaded,  $t_{CL}$  should be made less than or equal to the sum of the transition time and the fixed propagation delay of the output of the driving stage for the estimated capacitive load.

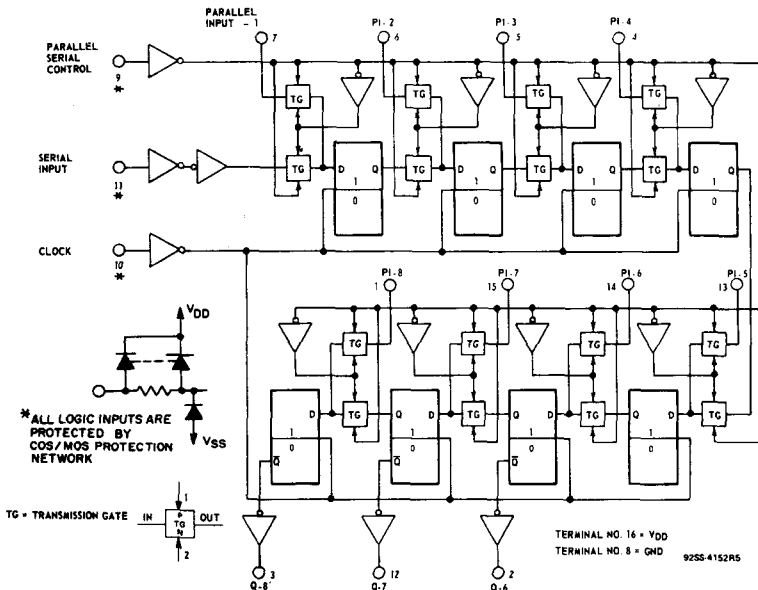

Fig. 5 - Logic block diagram.

## Applications:

- Synchronous parallel input/serial output data queuing
- Parallel to serial data conversion
- General-purpose register

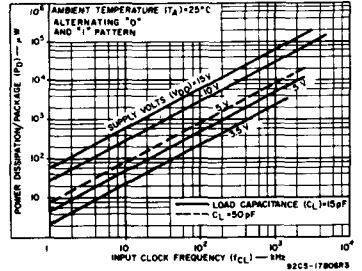

Fig. 2 - Typical dissipation characteristics.

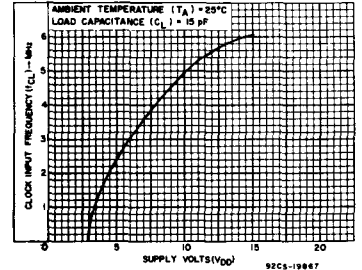

Fig. 3 - Typical clock input frequency vs. supply voltage.

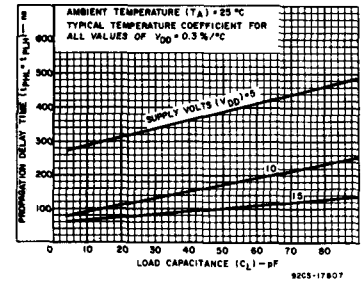

Fig. 4 - Typical propagation delay time vs. load capacitance.

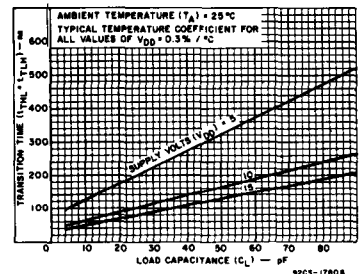

Fig. 6 - Typical transition time vs. load capacitance.

# CD4015A Types

## CMOS Dual 4-Stage Static Shift Register

### With Serial Input/Parallel Output

The RCA-CD4015A consists of two identical, independent, 4-stage serial-input/parallel-output registers. Each register has independent CLOCK and RESET inputs as well as a single serial DATA input. "Q" outputs are available from each of the four stages on both registers. All register stages are D-type, master-slave flip-flops. The logic level present at the DATA input is transferred into the first register stage and shifted over one stage at each positive-going clock transition.

Resetting of all stages is accomplished by a high level on the reset line. Register expansion to 8 stages using one CD4015A package, or to more than 8 stages using additional CD4015A's is possible.

These types are supplied in 16-lead hermetic dual-in-line ceramic packages (D and F suffixes), 16-lead dual-in-line plastic packages (E suffix), 16-lead ceramic flat packages (K suffix), and in chip form (H suffix).

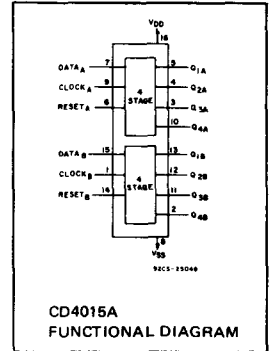

CD4015A  
FUNCTIONAL DIAGRAM

#### MAXIMUM RATINGS, Absolute-Maximum Values:

STORAGE-TEMPERATURE RANGE ( $T_{stg}$ )	-65 to +150°C
OPERATING-TEMPERATURE RANGE ( $T_A$ ):	
PACKAGE TYPES D, F, K, H	-55 to +125°C
PACKAGE TYPE E	-40 to +85°C
DC SUPPLY-VOLTAGE RANGE, ( $V_{DD}$ )	
(Voltages referenced to $V_{SS}$ Terminal)	-0.5 to +15 V
POWER DISSIPATION PER PACKAGE ( $P_D$ )	
FOR $T_A = -40$ to +60°C (PACKAGE TYPE E)	500 mW
FOR $T_A = +60$ to +85°C (PACKAGE TYPE E)	Derate Linearly at 12mW/°C to 200 mW
FOR $T_A = -55$ to +100°C (PACKAGE TYPES D, F, K)	500 mW
FOR $T_A = +100$ to +125°C (PACKAGE TYPES D, F, K)	Derate Linearly at 12 mW/°C to 200 mW
DEVICE DISSIPATION PER OUTPUT TRANSISTOR	
FOR $T_A =$ FULL PACKAGE-TEMPERATURE RANGE (ALL PACKAGE TYPES)	100 mW
INPUT VOLTAGE RANGE, ALL INPUTS	-0.5 to $V_{DD} + 0.5$ V
LEAD TEMPERATURE (DURING SOLDERING):	
At distance 1/16 ± 1/32 inch (1.59 ± 0.79 mm) from case for 10 s max.	+265°C

RECOMMENDED OPERATING CONDITIONS at  $T_A = 25^\circ\text{C}$ , Except as Noted.  
For maximum reliability, nominal operating conditions should be selected so that operation is always within the following ranges:

CHARACTERISTIC	$V_{DD}$ (V)	LIMITS				UNITS
		D, F, K, H PACKAGES		E PACKAGE		
		MIN.	MAX.	MIN.	MAX.	
Supply-Voltage Range (For $T_A =$ Full Package-Temperature Range)		3	12	3	12	V
Data Setup Time, $t_s$	5 10	350 80	—	500 100	—	ns
Clock Pulse Width, $t_W$	5 10	500 175	—	830 200	—	ns
Clock Input Frequency, $f_{CL}$	5 10	dc dc	1 3	dc dc	0.6 2.5	MHz
Clock Rise and Fall Time, $t_{rCL}$ , $t_{fCL}$ *	5 10	— —	15 5	— —	15 5	μs
Clock Reset Pulse Width, $t_W$	5 10	500 175	—	830 200	—	ns

\*If more than one unit is cascaded  $t_{rCL}$  should be made less than or equal to the sum of the transition time and the fixed propagation delay of the output of the driving stage for the estimated capacitive load.

#### Features:

- Medium speed operation . . . . . 5 MHz (typ.) clock rate at  $V_{DD} - V_{SS} = 10V$
- Fully static operation
- 8 master-slave flip-flops plus output buffering
- Quiescent current specified to 15 V
- Maximum input leakage current of 1 μA at 15 V (full package-temperature range)
- 1-V noise margin (full package-temperature range)

#### Applications:

- Serial-input/parallel-output data queuing
- Serial to parallel data conversion
- General-purpose register

#### TRUTH TABLE

$CL^A$	D	R	$Q_1$	$Q_n$
0	0	0	0	$Q_{n-1}$
1	0	1	0	$Q_{n-1}$
1	1	0	1	$Q_{n-1}$
X	X	0	$Q_1$	$Q_n$ (NO CHANGE)
X	X	1	0	0

$^A =$  LEVEL CHANGE  
X = DON'T CARE CASE

Fig. 1 - Truth table.

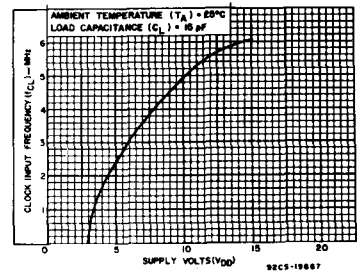

Fig. 2 - Typical clock input frequency vs. supply voltage.

# CD4015A Types

## STATIC ELECTRICAL CHARACTERISTICS

CHARACTERISTICS	CONDITIONS			LIMITS AT INDICATED TEMPERATURES (°C)								UNITS
				D, F, K, H PACKAGES				E PACKAGE				
	V <sub>O</sub> (V)	V <sub>IN</sub> (V)	V <sub>DD</sub> (V)	-55	+25		+125	-40	+25		+85	
Quiescent Device Current, I <sub>L</sub> Max.	-	-	5	5	0.5	5	300	50	0.5	50	700	μA
	-	-	10	10	1	10	600	100	1	100	1400	
	-	-	15	50	1	50	2000	500	5	500	5000	
Output Voltage: Low Level, V <sub>OL</sub>	-	5	5	0 Typ.; 0.05 Max								V
	-	10	10	0 Typ.; 0.05 Max								
	-	0	5	4.95 Min.; 5 Typ.								
High Level V <sub>OH</sub>	-	0	5	4.95 Min.; 5 Typ.								V
	-	0	10	9.95 Min.; 10 Typ.								
Noise Immunity: Inputs Low, V <sub>NL</sub>	4.2	-	5	1.5 Min.; 2.25 Typ.								V
	9	-	10	3 Min.; 4.5 Typ.								
Inputs High V <sub>NH</sub>	0.8	-	5	1.5 Min.; 2.25 Typ.								V
	1	-	10	3 Min.; 4.5 Typ.								
Noise Margin: Inputs Low, V <sub>NML</sub>	4.5	-	5	1 Min.								V
	9	-	10	1 Min.								
Inputs High, V <sub>NMH</sub>	0.5	-	5	1 Min.								V
	1	-	10	1 Min.								
Output Drive Current: N-Channel (Sink), I <sub>DN</sub> Min.	0.5	-	5	0.15	0.3	0.12	0.085	0.072	0.3	0.06	0.05	mA
	0.5	-	10	0.31	0.5	0.25	0.175	0.12	0.5	0.1	0.08	
	4.5	-	5	-0.1	-0.16	-0.08	-0.055	-0.06	-0.16	-0.05	-0.04	
P-Channel (Source): I <sub>DP</sub> Min.	9.5	-	10	-0.25	-0.44	-0.20	-0.14	-0.12	-0.44	-0.1	-0.08	mA
	9.5	-	10	-0.25	-0.44	-0.20	-0.14	-0.12	-0.44	-0.1	-0.08	
Input Leakage Current, I <sub>IL</sub> , I <sub>IH</sub>	Any Input			±10 <sup>-5</sup> Typ., ±1 Max.								μA
	-	-	15	±10 <sup>-5</sup> Typ., ±1 Max.								

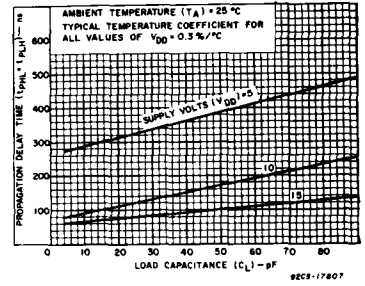

Fig. 3 - Typical propagation delay time vs. load capacitance.

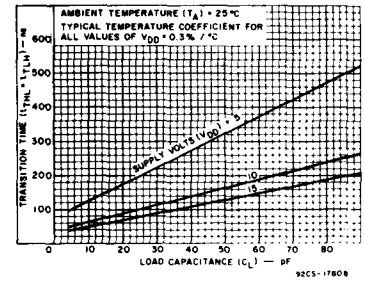

Fig. 4 - Typical transition time vs. load capacitance.

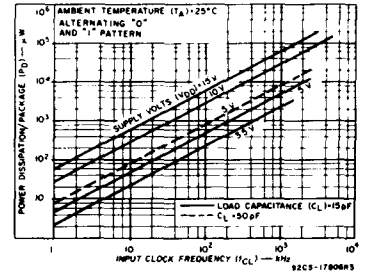

Fig. 5 - Typical dissipation characteristics.

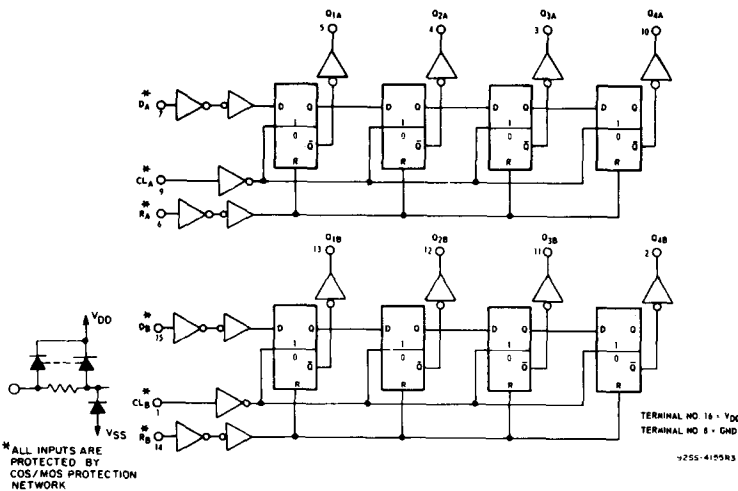

Fig. 6 - Logic diagram.

# CD4015A Types

## DYNAMIC ELECTRICAL CHARACTERISTICS

at  $T_A = 25^\circ\text{C}$ , Input  $t_r, t_f = 20\text{ ns}$ ,  $C_L = 15\text{ pF}$ ,  $R_L = 200\text{ k}\Omega$

CHARACTERISTIC	TEST CONDITIONS	LIMITS						UNITS
		D, F, K, H PACKAGES			E PACKAGE			
		MIN.	TYP.	MAX.	MIN.	TYP.	MAX.	
<b>CLOCKED OPERATION</b>								
Propagation Delay Time; $T_{PLH}, T_{PHL}$	5	—	300	750	—	300	1000	ns
	10	—	100	225	—	100	300	
Transition Time; $t_{THL}, t_{TLH}$	5	—	150	300	—	150	400	ns
	10	—	75	125	—	75	150	
Minimum Clock Pulse Width, $t_W$	5	—	200	500	—	200	830	ns
	10	—	100	175	—	100	200	
Clock Rise & Fall Time; $t_{fCL}, t_{rCL}^*$	5	—	—	15	—	—	15	$\mu\text{s}$
	10	—	—	5	—	—	5	
Minimum Data Set-up Time, $t_S$	5	—	100	350	—	100	500	ns
	10	—	50	80	—	50	100	
Maximum Clock Input Frequency, $f_{CL}$	5	1	2.5	—	0.6	2.5	—	MHz
	10	3	5	—	2.5	5	—	
Average Input Capacitance, $C_I$		—	5	—	—	5	—	pF
<b>RESET OPERATION</b>								
Propagation Delay Time, $T_{PHL}$	5	—	300	750	—	300	1000	ns
	10	—	100	225	—	100	300	
Minimum Reset Pulse Width $t_W$	5	—	200	500	—	200	830	ns
	10	—	100	175	—	100	200	

\*If more than one unit is cascaded  $t_{fCL}$  should be made less than or equal to the sum of the transition time and the fixed propagation delay of the output of the driving stage for the estimated capacitive load.

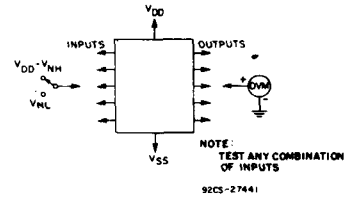

Fig. 7 — Noise-immunity test circuit.

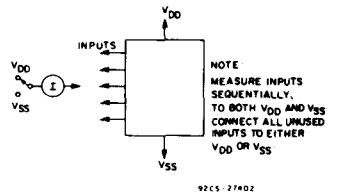

Fig. 8 — Input-leakage-current test circuit.

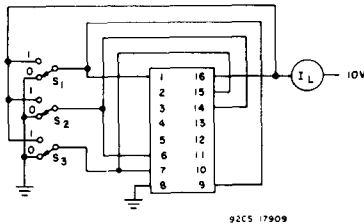
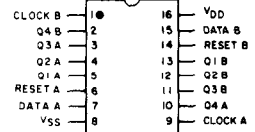

Fig. 9 — Quiescent-device-current test circuit.

Test performed with the following sequence of "1's" and "0's"

	S <sub>1</sub>	S <sub>2</sub>	S <sub>3</sub>
Test	0	1	0
Don't Test	0	0	1
Don't Test	1	0	1
Don't Test	0	0	0
Don't Test	1	0	0
Don't Test	0	0	1
Test	1	0	1
Don't Test	0	0	0
Test	1	0	0

### TERMINAL DIAGRAM Top View





# CMOS Quad Bilateral Switch

For Transmission or Multiplexing of Analog or Digital Signals

The RCA-CD4016A Series types are quad bilateral switches intended for the transmission or multiplexing of analog or digital signals. Each of the four independent bilateral switches has a single control signal input which simultaneously biases both the p and n device in a given switch ON or OFF. These types are supplied in 14-lead hermetic dual-in-line ceramic packages (D and F suffixes), 14-lead dual-in-line plastic packages (E suffix), 14-lead ceramic flat packages (K suffix), and in chip form (H suffix).

**Features:**

- 15-V digital or  $\pm 7.5$ -V peak-to-peak switching
- 280- $\Omega$  typical ON resistance for 15-V operation
- Switch ON resistance matched to within 10  $\Omega$  typ. over 15-V signal-input range
- High ON/OFF output-voltage ratio: 65 dB typ. @  $f_{is} = 10$  kHz,  $R_L = 10$  k $\Omega$

- High degree of linearity: <0.5% distortion typ. @  $f_{is} = 1$  kHz,  $V_{is} = 5$  V<sub>p-p</sub>,  $V_{DD} - V_{SS} \geq 10$  V,  $R_L = 10$  k $\Omega$
- Extremely low OFF switch leakage resulting in very low offset current and high effective OFF resistance: 100 pA typ. @  $V_{DD} - V_{SS} = 10$  V,  $T_A = 25^\circ\text{C}$
- Extremely high control input impedance (control circuit isolated from signal circuit: 10<sup>12</sup>  $\Omega$  typ.)
- Low crosstalk between switches: -50 dB typ. @  $f_{is} = 0.9$  MHz,  $R_L = 1$  k $\Omega$
- Matched control-input to signal-output capacitance: Reduces output signal transients
- Frequency response, switch ON = 40 MHz (typ.)
- Quiescent current specified to 15 V
- Maximum input leakage current of 1  $\mu\text{A}$  at 15 V (full package-temperature range)

**Applications:**

- Analog signal switching/multiplexing
- Signal gating
- Squelch control
- Chopper
- Modulator
- Demodulator
- Commutating switch

**RECOMMENDED OPERATING CONDITIONS**

For maximum reliability, nominal operating conditions should be selected so that operation is always within the following range:

CHARACTERISTIC	LIMITS		UNITS
	Min.	Max.	
Supply Voltage Range (For $T_A =$ Full Package Temperature Range)	3	12	V

**TYPICAL "ON" RESISTANCE CHARACTERISTICS**

CHARACTERISTIC*	SUPPLY CONDITIONS		LOAD CONDITIONS					
	$V_{DD}$ (V)	$V_{SS}$ (V)	$R_L = 1\text{k}\Omega$		$R_L = 10\text{k}\Omega$		$R_L = 100\text{k}\Omega$	
			VALUE ( $\Omega$ )	$V_{is}$ (V)	VALUE ( $\Omega$ )	$V_{is}$ (V)	VALUE ( $\Omega$ )	$V_{is}$ (V)
$R_{ON}$	+15	0	200	+15	200	+15	180	+15
$R_{ON(max)}$	+15	0	300	+11	300	+9.3	320	+9.2
$R_{ON}$	+10	0	290	+10	250	+10	240	+10
$R_{ON(max)}$	+10	0	500	+7.4	560	+5.6	610	+5.5
$R_{ON}$	+5	0	860	+5	470	+5	450	+5
$R_{ON(max)}$	+5	0	600	0	580	0	800	0
$R_{ON}$	+5	0	1.7k	+4.2	7k	+2.9	33k	+2.7
$R_{ON}$	+7.5	-7.5	200	+7.5	200	+7.5	180	+7.5
$R_{ON(max)}$	+7.5	-7.5	200	-7.5	200	-7.5	180	-7.5
$R_{ON}$	+7.5	-7.5	290	+0.25	280	+0.25	400	+0.25
$R_{ON}$	+5	-5	260	+5	250	+5	240	+5
$R_{ON(max)}$	+5	-5	310	-5	250	-5	240	-5
$R_{ON}$	+5	-5	600	+0.25	580	+0.25	760	+0.25
$R_{ON}$	+2.5	-2.5	590	+2.5	450	+2.5	490	+2.5
$R_{ON(max)}$	+2.5	-2.5	720	-2.5	520	-2.5	520	-2.5
$R_{ON}$	+2.5	-2.5	232k	$\pm 0.25$	300k	$\pm 0.25$	870k	$\pm 0.25$

\* Variation from a perfect switch,  $R_{ON} = 0\Omega$ .

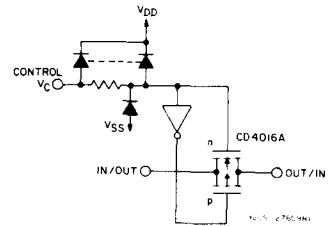
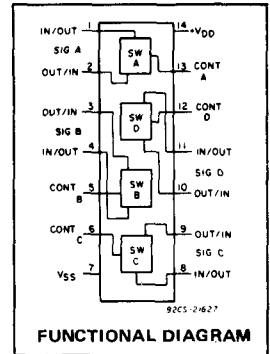

Fig. 1—Schematic diagram — 1 of 4 identical sections.

- Digital signal switching/multiplexing
- CMOS logic implementation
- Analog-to-digital & digital-to-analog conversion
- Digital control of frequency, impedance, phase, and analog-signal gain

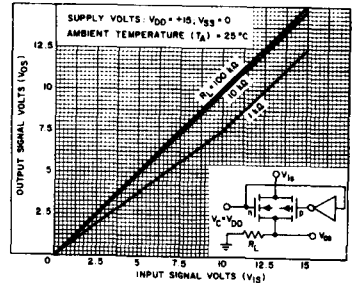

Fig. 2—Typ. "ON" characteristics for 1 of 4 switches with  $V_{DD} = +15$  V,  $V_{SS} = 0$  V.

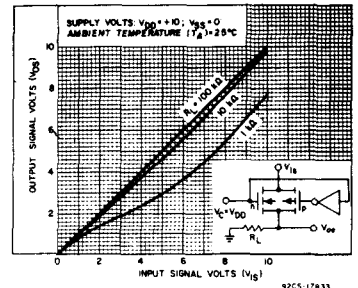

Fig. 3—Typ. "ON" characteristics for 1 of 4 switches with  $V_{DD} = +10$  V,  $V_{SS} = 0$  V.

# CD4016A Types

**ELECTRICAL CHARACTERISTICS (All inputs. . . . .  $V_{SS} \leq V_i \leq V_{DD}$ )**  
**Recommended DC Supply Voltage ( $V_{DD}-V_{SS}$ ) . . . 3 to 15 V**

Characteristic	Test Conditions All Voltage Values are in Volts	Limits						Unit
		Values at $-55^{\circ}\text{C}$ , $+25^{\circ}\text{C}$ , $+125^{\circ}\text{C}$ Apply to D, F, K, H Packages						
		Values at $-40^{\circ}\text{C}$ , $+25^{\circ}\text{C}$ , $+85^{\circ}\text{C}$ Apply to E Package						
$V_{DD}$ (V)	$-55^{\circ}$	$-40^{\circ}$	$+85^{\circ}$	$+125^{\circ}$	$+25^{\circ}\text{C}$			
					Typ.	Max.		
Quiescent Device Current, $I_L$ max (All switches ON or all Switches OFF) D, F, H Pkgs.	$V_{DD} = 5$	0.25	—	—	10	0.01	0.25	$\mu\text{A}$
	$V_{DD} = 10$	0.5	—	—	20	0.01	0.5	
	$V_{DD} = 15$	2	—	—	40	0.01	2	
E, Y Pkgs.	$V_{DD} = 5$	—	0.25	5	—	—	0.25	$\mu\text{A}$
	$V_{DD} = 10$	—	0.5	10	—	—	0.5	
	$V_{DD} = 15$	—	2	20	—	—	2	

Signal Inputs ( $V_{iS}$ ) and Outputs ( $V_{oS}$ )										
Characteristic	$V_C = V_{DD}$	$V_{SS}$	$V_{iS}$	Limits				Unit		
	Typ/Max				Typ/Max		Typ/Max			
ON Resistance, RON	$R_L = 10\text{ k}\Omega^{\bullet}$								$\Omega$	
	+7.5	-7.5	+7.5	120/360	130/370	260/520	300/600	200		400
			-7.5	120/360	130/370	260/520	300/600	200		400
			$\pm 0.25$	130/775	160/790	400/1080	470/1230	280		850
	+5	-5	+5	130/600	150/610	340/840	400/960	250		660
			-5	130/600	150/610	340/840	400/960	250		660
			$\pm 0.25$	325/1870	370/1900	770/2380	900/2600	580		2000
	+15	0	+15	120/360	130/370	260/520	300/600	200		400
			$\pm 0.25$	120/360	130/370	260/520	300/600	200		400
			+9.3	150/775	180/790	400/1080	490/1230	300		850
	+10	0	+10	130/600	150/610	340/840	400/960	250		660
			$\pm 0.25$	130/600	150/610	340/840	400/960	250		660
+5.6			300/1870	350/1900	750/2380	880/2600	560	2000		
$\Delta$ ON Resistance Between Any 2 of 4 Switches $\Delta$ RON	$R_L = 10\text{ k}\Omega^{\bullet}$								$\Omega$	
	+7.5	-7.5	$\pm 7.5$	—	—	—	—	10		—
Sine Wave Response (Distortion)	+5	-5	5 p-p $\Delta$							"
	$R_L = 10\text{ k}\Omega$ $f_{iS} = 1\text{ kHz}$			—	—	—	—	0.4	—	
Frequency Response Switch ON (Sine-Wave Input)	$V_{DD} = +5$ $V_C = V_{SS} = -5$									MHz
	$R_L = 1\text{ k}\Omega$ $20 \log_{10} \frac{V_{oS}}{V_{iS}} = -3\text{ dB}$			—	—	—	—	40	—	
Feedthrough Switch OFF	+5	-5	-5 p-p							MHz
	$R_L = 1\text{ k}\Omega$ $20 \log_{10} \frac{V_{oS}}{V_{iS}} = -50\text{ dB}$			—	—	—	—	1.25	—	
Input or Output Leakage Current Switch OFF (Effective OFF Resistance)	$V_{DD}$	$V_C = V_{SS}$								$\mu\text{A}$
	+7.5	-7.5	$\pm 7.5$	—	—	—	—	$\pm 100$	—	
	+5	-5	$\pm 5$	—	—	—	—	$\pm 10 \times 10^{-3}$	$\pm 125^*$	nA

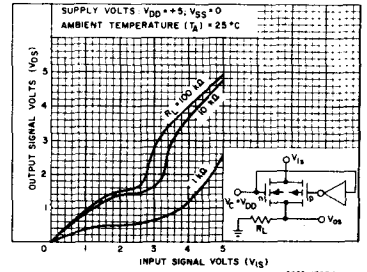

Fig. 4 - Typ. "ON" characteristics for 1 of 4 switches with  $V_{DD} = +5\text{ V}$ ,  $V_{SS} = 0\text{ V}$ .

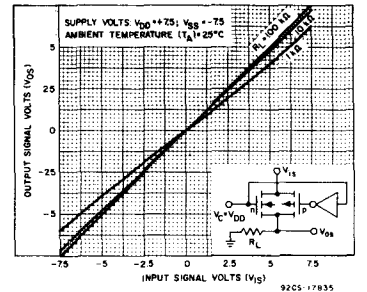

Fig. 5 - Typ. "ON" characteristics for 1 of 4 switches with  $V_{DD} = +7.5\text{ V}$ ,  $V_{SS} = -7.5\text{ V}$ .

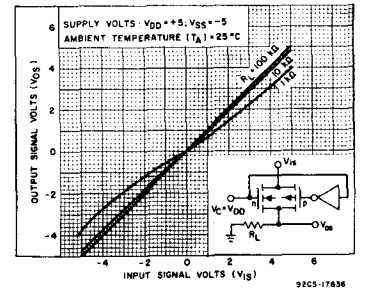

Fig. 6 - Typ. "ON" characteristics for 1 of 4 switches with  $V_{DD} = +5\text{ V}$ ,  $V_{SS} = -5\text{ V}$ .

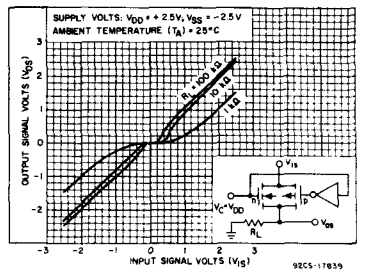

Fig. 7 - Typ. "ON" characteristics for 1 of 4 switches with  $V_{DD} = +2.5\text{ V}$ ,  $V_{SS} = -2.5\text{ V}$ .

# CD4016A Types

## ELECTRICAL CHARACTERISTICS (Cont'd) . . . . . $V_{SS} \leq V_I \leq V_{DD}$ Recommended DC Supply Voltage ( $V_{DD}-V_{SS}$ ) . . . 3 to 15 V

Characteristic	Test Conditions All Voltage Values are in Volts	Limits							Unit
		Values at -55°C, +25°C, +125°C Apply to D, F, K, H Packages Values at -40°C, +25°C, +85°C Apply to E Package						+25°C	
		-55°	-40°	+85°	+125°	Typ.	Max.		
Crosstalk Between Any 2 of 4 Switches (f = -50 dB)	$V_C(A) = V_{DD} = +5$ $V_C(B) = V_{SS} = -5$ $V_{is}(A) = 5$ p-p $R_L = 1$ kΩ $20 \log_{10} \frac{V_{os}(B)}{V_{is}(A)} = -50$ dB						0.9		MHz
Propagation Delay (Signal Input to Signal Output) $t_{pd}$	$V_C = V_{DD}$ $V_{SS} = GND$ $C_L = 50$ pF $V_{is} = 10$ Sq. Wave $t_r, t_f = 20$ ns	$V_{DD}$ 5					20	50	ns
Capacitance: Input, $C_{is}$ Output, $C_{os}$ Feedthrough, $C_{ios}$	$V_{DD} = +5$ $V_{CC} = V_{SS} = -5$						4		μF
<b>Control (<math>V_C</math>)†</b>									
Switch Threshold Voltage, $V_{TH}$	$V_{is} \leq V_{DD}, I_{is} = 10 \mu A$ $V_{DD} - V_{SS} = 15, 10, 5$	0.7 min 2.9 max	-	-	-	0.2 min 2.4 max	0.5 min 1.5	2.7	V
Input Leakage Current, $I_{IL}$ max	$V_{is} \leq V_{DD}$ $V_{DD} = 15$							$\pm 10^{-5}$ typ; $\pm 1$ max.	μA
Crosstalk (Control Input to Signal Output)	$V_C = 10$ (Sq. Wave) $t_r, t_f = 20$ ns $R_L = 10$ kΩ $V_{DD} = 10$						50		mV
Turn-On Propagation Delay, $t_{pdc}$	$V_{DD} - V_{SS} = 10$ $V_C = 10$ (See Fig. 25) $t_r, t_f = 20$ ns $C_L = 15$ pF $R_L = 1$ kΩ	$V_{DD}$ 5					20 10	40 20	ns
Maximum Allowable Control Input Repetition Rate	$V_{DD} = 10$ , $V_{SS} = GND$ $R_L = 1$ kΩ, $C_L = 15$ pF $V_{CC} = 10$ (Sq. Wave) $t_r, t_f = 20$ ns						10		MHz
Av. Input Capacitance, $C_I$							5		μF

- \* Limit determined by minimum feasible leakage current measurement for automatic testing.
- ▲ Symmetrical about 0 volts.
- For all test conditions.
- † All control inputs protected by COS/MOS protection network.

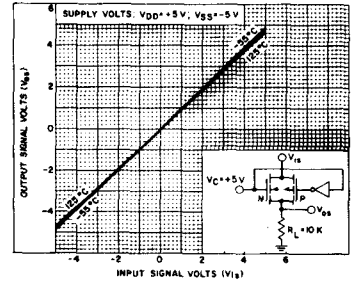

Fig. 8 - Typ. "ON" characteristics as a function of temp. for 1 of 4 switches with  $V_{DD} = +5$  V,  $V_{SS} = -5$  V.

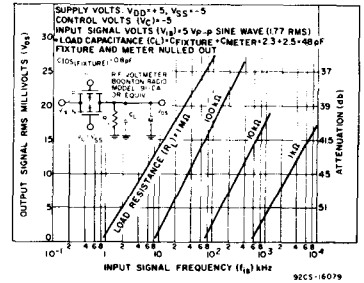

Fig. 9 - Typ. feedthru vs. frequency - switch "OFF".

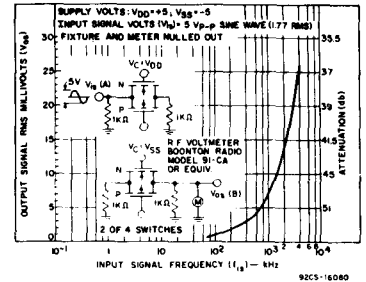

Fig. 10 - Typical crosstalk between switch circuits in the same package.

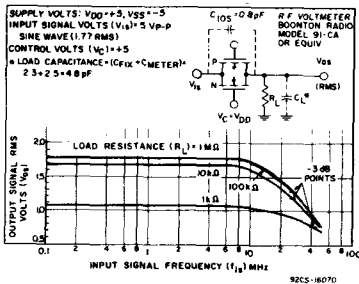

Fig. 11 - Typical switch frequency response - switch "ON".

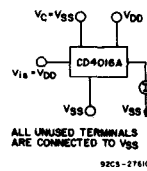

Fig. 12 - "OFF" switch input or output leakage current test circuit.

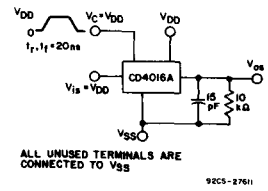
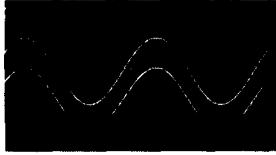

Fig. 13 - Test circuit for square-wave response.

# CD4016A Types



SCALE: X = 0.2 ms/DIV Y = 2.0 V/DIV  
 $V_{DD} = V_C = +7.5V, V_{SS} = -7.5V, R_L = 10K\Omega$   
 $C_L = 15 pF$   
 $f_{IS} = 1 KHz, V_{IS} = 5V p-p$   
 DISTORTION = 0.2 %

92CS-27612

Fig. 14 - Typical sine wave response of  $V_{DD}$  = +7.5 V,  $V_{SS}$  = -7.5 V.

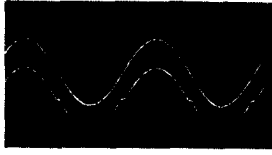

SCALE: X = 0.2 ms/DIV Y = 2.0 V/DIV  
 $V_{DD} = V_C = +2.5V, V_{SS} = -2.5V, R_L = 10K\Omega$   
 $C_L = 15 pF$   
 $f_{IS} = 1 KHz, V_{IS} = 5V p-p$   
 DISTORTION = 3 %

92CS-27614

Fig. 15 - Typical sine wave response of  $V_{DD}$  = +2.5 V,  $V_{SS}$  = -2.5 V.

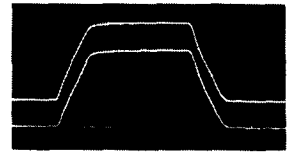

SCALE: X = 100 ns/DIV  
 Y = 5.0 V/DIV

92CS-27615

Fig. 16 - Typical square wave response at  $V_{DD} = V_C = +15 V, V_{SS} = Gnd.$

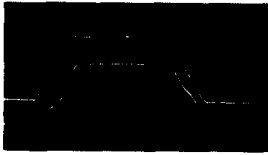

SCALE: X = 100 ns/DIV  
 Y = 2 V/DIV

92CS-27617

Fig. 17 - Typical square wave response at  $V_{DD} = V_C = +5 V, V_{SS} = Gnd.$

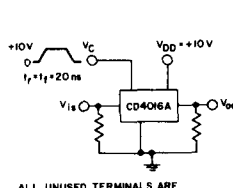

ALL UNUSED TERMINALS ARE CONNECTED TO  $V_{SS}$

(a)

Fig. 18 - Crosstalk-control input to signal output.

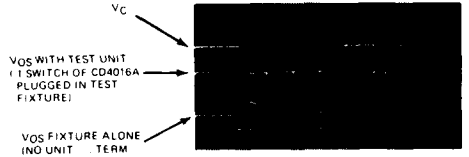

$V_C = 10V$  PER DIV  
 $V_{OS} = 0.2V$  PER DIV  
 100ns PER DIV

92CS-27618

(b)

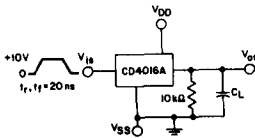

ALL UNUSED TERMINALS ARE CONNECTED TO  $V_{SS}$

92CS-27619

Fig. 19 - Propagation delay time signal input ( $V_{IS}$ ) to signal output ( $V_{OS}$ ).

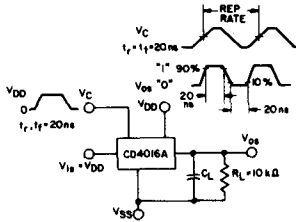

ALL UNUSED TERMINALS ARE CONNECTED TO  $V_{SS}$

92CS-27620

Fig. 20 - Max. allowable control-input repetition rate.

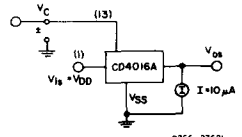

92CS-27621

SWITCH THRESHOLD VOLTAGE IS DEFINED AS THE VOLTAGE APPLIED TO A TRANSMISSION GATE CONTROL WHICH CAUSES 10  $\mu A$  OF TRANSMISSION GATE CURRENT.

Fig. 21 - Switch threshold voltage.

## MAXIMUM RATINGS, Absolute-Maximum Values:

STORAGE-TEMPERATURE RANGE ( $T_{stg}$ )	-65 to +150°C
OPERATING-TEMPERATURE RANGE ( $T_A$ ):	
PACKAGE TYPES D, F, K, H	-55 to +125°C
PACKAGE TYPE E	-40 to +85°C
DC SUPPLY-VOLTAGE RANGE, ( $V_{DD}$ )	
(Voltages referenced to $V_{SS}$ Terminal)	-0.5 to +15 V
POWER DISSIPATION PER PACKAGE ( $P_D$ ):	
FOR $T_A = -40$ to +60°C (PACKAGE TYPE E)	500 mW
FOR $T_A = +60$ to +85°C (PACKAGE TYPE E)	Derate Linearly at 12 mW/°C to 200 mW
FOR $T_A = -55$ to +100°C (PACKAGE TYPES D, F, K)	500 mW
FOR $T_A = +100$ to +125°C (PACKAGE TYPES D, F, K)	Derate Linearly at 12 mW/°C to 200 mW
DEVICE DISSIPATION PER OUTPUT TRANSISTOR	
FOR $T_A =$ FULL PACKAGE-TEMPERATURE RANGE (ALL PACKAGE TYPES)	100 mW
INPUT VOLTAGE RANGE, ALL INPUTS	-0.5 to $V_{DD} + 0.5 V$
LEAD TEMPERATURE (DURING SOLDERING)	
At distance 1/16 $\pm$ 1/32 inch (1.59 $\pm$ 0.79 mm) from case for 10 s max.	+265°C

MEASURED ON BOONTON CAPACITANCE BRIDGE MODEL 79 A (1 MHz)

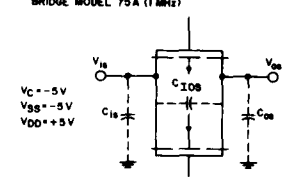

ALL UNUSED TERMINALS ARE CONNECTED TO  $V_{SS}$

92CS-27622

Fig. 22 - Capacitance  $C_{IOS}$  and  $C_{OS}$ .

# CMOS Decade Counter/Divider

## Plus 10 Decoded Decimal Outputs

The RCA-CD4017A consists of a 5-stage Johnson decade counter and an output decoder which converts the Johnson binary code to a decimal number. Inputs include a CLOCK, a RESET, and a CLOCK INHIBIT signal.

The decade counter is advanced one count at the positive clock signal transition if the CLOCK INHIBIT signal is low. Counter advancement via the clock line is inhibited when the clock INHIBIT signal is high. A high reset signal clears the decade counter to

its zero count. Use of the Johnson decade counter configuration permits high speed operation, 2-input decimal decode gating, and spike-free decoded outputs. Anti-lock gating is provided, thus assuring proper counting sequence. The 10 decoded outputs are normally low and go high only at their respective decimal time slot. Each decoded output remains high for one full clock cycle. A CARRY-OUT (COUT) signal completes one cycle every 10 clock input cycles and is used to clock the succeeding decade directly in a multi-decade counting chain.

These types are supplied in 16-lead hermetic dual-in-line ceramic packages (D and F suffixes), 16-lead dual-in-line plastic packages (E suffix), 16-lead ceramic flat packages (K suffix), and in chip form (H suffix).

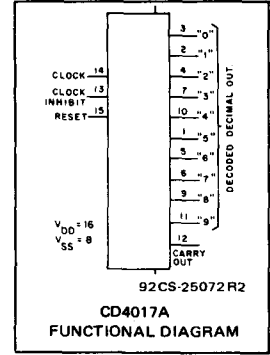

### MAXIMUM RATINGS, Absolute-Maximum Values:

STORAGE-TEMPERATURE RANGE ( $T_{stg}$ )	-65 to +150°C
OPERATING-TEMPERATURE RANGE ( $T_A$ ):	
PACKAGE TYPES D, F, K, H	-55 to +125°C
PACKAGE TYPE E	-40 to +85°C
DC SUPPLY-VOLTAGE RANGE ( $V_{DD}$ )	
(Voltages referenced to $V_{SS}$ Terminal)	-0.5 to +15 V
POWER DISSIPATION PER PACKAGE ( $P_D$ ):	
FOR $T_A = -40$ to $+60^\circ\text{C}$ (PACKAGE TYPE E)	500 mW
FOR $T_A = +60$ to $+85^\circ\text{C}$ (PACKAGE TYPE E)	Derate Linearly at 12 mW/°C to 200 mW
FOR $T_A = -55$ to $+100^\circ\text{C}$ (PACKAGE TYPES D, F, K)	500 mW
FOR $T_A = +100$ to $+125^\circ\text{C}$ (PACKAGE TYPES D, F, K)	Derate Linearly at 12 mW/°C to 200 mW
DEVICE DISSIPATION PER OUTPUT TRANSISTOR	
FOR $T_A = \text{FULL PACKAGE-TEMPERATURE RANGE (ALL PACKAGE TYPES)}$	100 mW
INPUT VOLTAGE RANGE, ALL INPUTS	-0.5 to $V_{DD} + 0.5$ V
LEAD TEMPERATURE (DURING SOLDERING):	
At distance 1/16 ± 1/32 inch (1.59 ± 0.79 mm) from case for 10 s max.	+265°C

### Features:

- Synchronous decade counter plus 10 decoded outputs
- Fully static operation
- Medium speed operation. . . . . 5 MHz (typ.) at  $V_{DD} - V_{SS} = 10$  V
- Quiescent current specified to 15 V
- Maximum input leakage current of 1  $\mu\text{A}$  at 15 V (full package-temperature range)
- 1-V noise margin (full package-temperature range)

### Applications:

- Decade counter/decimal decode display
- Frequency division
- Counter control/timers
- Divide by N counting  
N = 2 - 10 with one CD4017A and one CD4001A  
N > 10 with multiple CD4017A's
- For further application information, see ICAN-6166 "CMOS MSI Counter and Register Design & Applications"

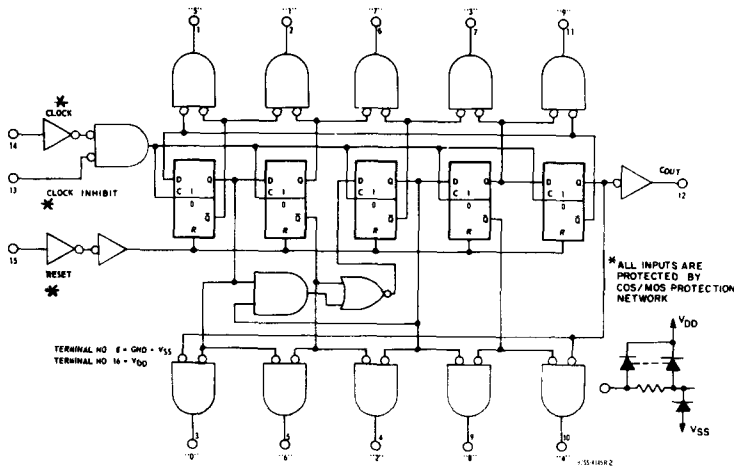

Fig. 1 - Logic diagram.

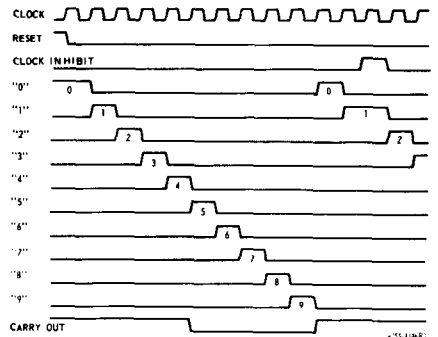

Fig. 2 - Timing diagram.

# CD4017A Types

## STATIC ELECTRICAL CHARACTERISTICS

CHARACTERISTICS	CONDITIONS			LIMITS AT INDICATED TEMPERATURES (°C)								UNITS			
	V <sub>O</sub> (V)	V <sub>IN</sub> (V)	V <sub>DD</sub> (V)	D, F, K, H PACKAGES				E PACKAGE							
				-55	+25		+125	-40	+25		+85				
Quiescent Device Current, I <sub>L</sub> Max.	-	-	5	5	0.3	5	300	50	0.5	50	700	μA			
	-	-	10	10	0.5	10	600	100	1	100	1400				
	-	-	15	50	1	50	2000	500	5	500	5000				
Output Voltage: Low-Level, V <sub>OL</sub>	-	5	5	0 Typ.; 0.05 Max.								V			
	-	10	10	0 Typ.; 0.05 Max.											
High Level V <sub>OH</sub>	-	0	5	4.95 Min.; 5 Typ.								V			
	-	0	10	9.95 Min.; 10 Typ.											
Noise Immunity: Inputs Low, V <sub>NL</sub>	4.2	-	5	1.5 Min.; 2.25 Typ.								V			
	9	-	10	3 Min.; 4.5 Typ.											
Inputs High V <sub>NH</sub>	0.8	-	5	1.5 Min.; 2.25 Typ.								V			
	1	-	10	3 Min.; 4.5 Typ.											
Noise Margin Inputs Low V <sub>NML</sub>	4.5	-	5	1 Min.								V			
	9	-	10	1 Min.											
Inputs High, V <sub>NMH</sub>	0.5	-	5	1 Min.								V			
	1	-	10	1 Min.											
Output Drive Current: N-Channel (Sink)	I <sub>DN</sub> Min	Decoded Outputs	0.5	-	5	0.06	0.1	0.05	0.035	0.03	0.1	0.025	0.02	mA	
		Carry Output	0.5	-	5	0.185	0.4	0.15	0.105	0.085	0.4	0.08	0.065		
	P-Channel (Source)	I <sub>DP</sub> Min	Decoded Outputs	4.5	-	5	-0.0375	-0.075	-0.03	-0.021	-0.018	-0.075	-0.015		-0.012
			Carry Output	4.5	-	5	-0.185	-0.4	-0.15	-0.105	-0.085	-0.4	-0.08		-0.065
	Input Leakage Current, I <sub>IL</sub> , I <sub>IH</sub>	Any Input	-	-	15	±10 <sup>-5</sup> Typ., ±1 Max.									μA

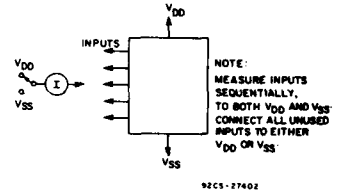

Fig. 10 - Input-leakage-current test circuit.

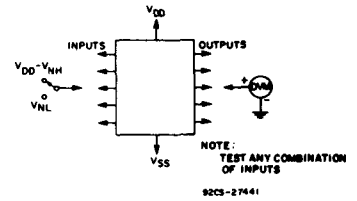

Fig. 11 - Noise-immunity test circuit.

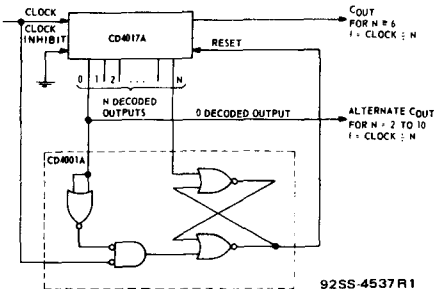

Fig. 12 - Divide by N counter (N ≤ 10) with N decoded outputs.

When the N<sup>th</sup> decoded output is reached (N<sup>th</sup> clock pulse) the S-R flip flop (constructed from two NOR gates of the CD4001A) generates a reset pulse which clears the CD4017A to its zero count. At this time, if the N<sup>th</sup> decoded output is greater than or equal to 6, the COUT line goes high to clock the next CD4017A counter section. The "0" decoded output also goes high at this time. Coincidence of the clock low and decoded "0" output low resets the S-R flip flop to enable the CD4017A. If the N<sup>th</sup> decoded output is less than 6, the COUT line will not go high and, therefore, cannot be used. In this case "0" decoded output may be used to perform the clocking function for the next counter.

# CD4017A Types

**RECOMMENDED OPERATING CONDITIONS** at  $T_A = 25^\circ\text{C}$ , Except as Noted.  
 For maximum reliability, nominal operating conditions should be selected so that operation is always within the following ranges:

CHARACTERISTIC	V <sub>DD</sub> (V)	LIMITS				UNITS
		D, F, K, H PACKAGES		E PACKAGE		
		MIN.	MAX.	MIN.	MAX.	
Supply Voltage Range (For $T_A = \text{Full Package-Temperature Range}$ )		3	12	3	12	V
Clock Inhibit Setup Time, $t_S$	5 10	500 200	— —	700 300	— —	ns
Clock Pulse Width, $t_W$	5 10	500 170	— —	830 250	— —	ns
Clock Input Frequency, $f_{CL}$	5 10	dc dc	1 3	dc dc	0.6 2	MHz
Clock Rise or Fall Time, $t_{rCL}$ , $t_{fCL}$	5 10	— —	15 15	— —	15 15	$\mu\text{s}$
Reset Pulse Width, $t_W$	5 10	500 165	— —	830 250	— —	ns
Reset Removal Time	5 10	750 225	— —	1000 275	— —	ns

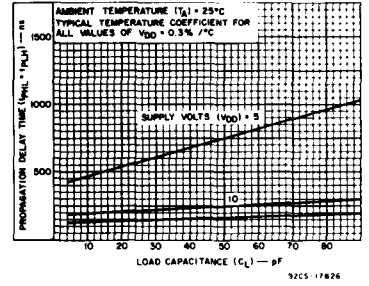

Fig. 3 — Typical propagation delay time vs.  $C_L$  for decoded outputs.

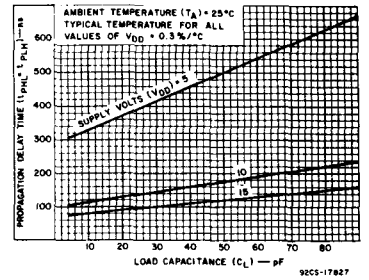

Fig. 4 — Typical propagation delay time vs.  $C_L$  for carry output.

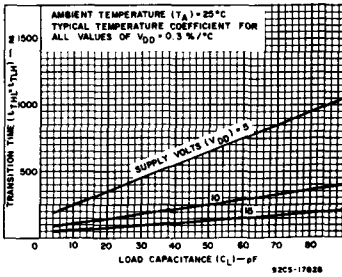

Fig. 5 — Typical transition time vs.  $C_L$  for decoded outputs.

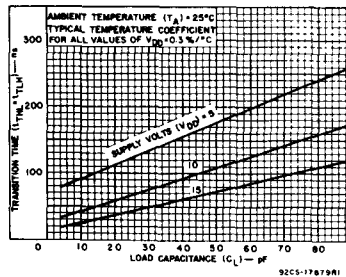

Fig. 6 — Typical transition time vs.  $C_L$  for carry output.

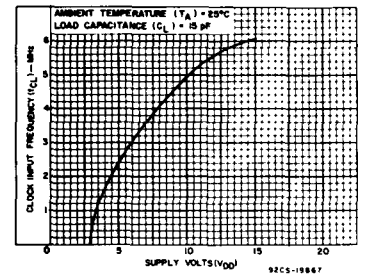

Fig. 7 — Typical clock input frequency vs.  $V_{DD}$ .

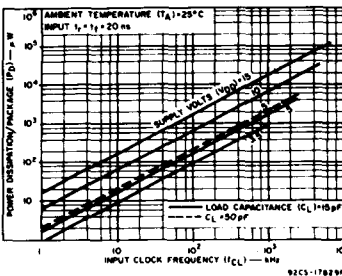

Fig. 8 — Typical dissipation characteristics.

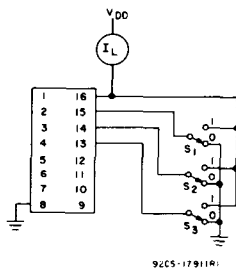

Fig. 9 — Quiescent device current test circuit.

Test performed with the following sequence of "1's" and "0's" at each switch.

S1	S2	S3	S1	S2	S3
1	1	1	0	1	0
0	0	0	0	0	0
0	1	0	0	1	0
0	0	0	0	0	0
0	1	0	0	1	0
0	0	0	0	0	0
0	0	0	0	1	0

# CD4017A Types

## DYNAMIC ELECTRICAL CHARACTERISTICS

At  $T_A = 25^\circ\text{C}$ , Input  $t_r, t_f = 20 \text{ ns}$ ,  $C_L = 15 \text{ pF}$ ,  $R_L = 200 \text{ k}\Omega$

CHARACTERISTIC	TEST CONDITIONS	LIMITS						UNITS	
		$V_{DD}$ (V)	D, F, K, H PACKAGES			E PACKAGE			
			MIN.	TYP.	MAX.	MIN.	TYP.		MAX.
<b>CLOCKED OPERATION</b>									
Propagation Delay Time; $t_{PHL}$ $t_{PLH}$ Carry Out Line		5	—	350	1000	—	350	1300	ns
		10	—	125	250	—	125	300	
Decode Out Lines		5	—	500	1200	—	500	1600	ns
		10	—	200	400	—	200	500	
Transition Time; $t_{THL}$ $t_{TLH}$ Carry Out Line		5	—	100	300	—	100	350	ns
		10	—	50	150	—	50	200	
Decode Out Lines		5	—	300	900	—	300	1200	ns
		10	—	125	350	—	125	450	
Maximum Clock Input Frequency, $f_{CL}^*$		5	1	2.5	—	0.6	2.5	—	MHz
		10	3	5	—	2	5	—	
Minimum Clock Pulse Width, $t_W$		5	—	200	500	—	200	830	ns
		10	—	100	170	—	100	250	
Clock Rise & Fall Time; $t_{rCL}$ , $t_{fCL}$		5	—	—	15	—	—	15	$\mu\text{s}$
		10	—	—	15	—	—	15	
Minimum Clock Inhibit Set-Up Time, $t_s$		5	—	175	500	—	175	700	ns
		10	—	75	200	—	75	300	
Average Input Capacitance, $C_I$	Any Input	—	5	—	—	5	—	pF	
<b>RESET OPERATION</b>									
Propagation Delay Time; $t_{PHL}$ To Carry Out Line		5	—	350	1000	—	350	1300	ns
		10	—	125	250	—	125	300	
To Decode Out Lines		5	—	450	1200	—	450	1600	ns
		10	—	200	400	—	200	500	
Minimum Reset Pulse Width, $t_W$		5	—	200	500	—	200	830	ns
		10	—	100	165	—	100	250	
Minimum Reset Removal Time		5	—	300	750	—	300	1000	ns
		10	—	100	225	—	100	275	

\*Measured with respect to carry output line



# CMOS Presettable Divide-By-'N' Counter

The RCA-CD4018A types consist of 5 Johnson-Counter stages, buffered  $\bar{Q}$  outputs from each stage, and counter preset control gating. CLOCK, RESET, DATA, PRESET ENABLE, and 5 individual JAM inputs are provided. Divide by 10, 8, 6, 4, or 2 counter configurations can be implemented by feeding the  $\bar{Q}_5, \bar{Q}_4, \bar{Q}_3, \bar{Q}_2, \bar{Q}_1$  signals, respectively, back to the DATA input. Divide-by-9, 7, 5, or 3 counter configurations can be implemented by the use of a CD4011A gate package to properly gate the feedback connection to the DATA input. Divide-by functions greater than 10 can be achieved by use of multiple CD4018A

units. The counter is advanced one count at the positive clock-signal transition. A high RESET signal clears the counter to an all-zero condition. A high PRESET-ENABLE signal allows information on the JAM inputs to preset the counter. Anti-lock gating is provided to assure the proper counting sequence.

These types are supplied in 16-lead hermetic dual-in-line ceramic packages (D and F suffixes), 16-lead dual-in-line plastic package (E suffix), 16-lead ceramic flat package (K suffix), and in chip form (H suffix).

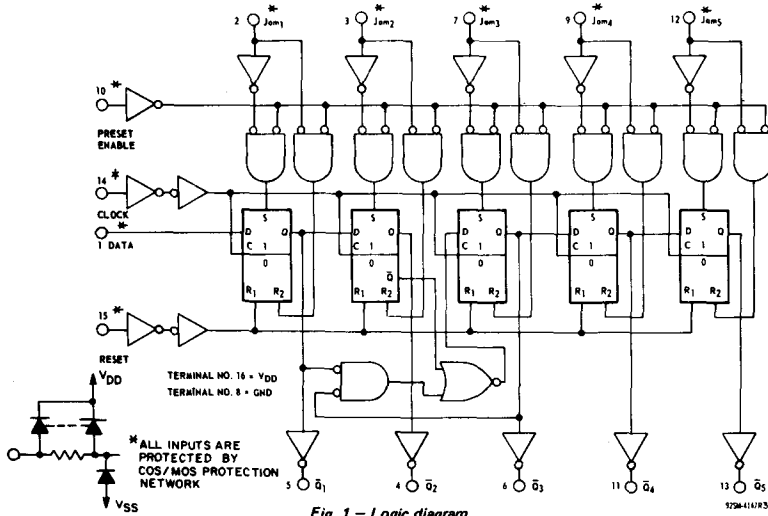
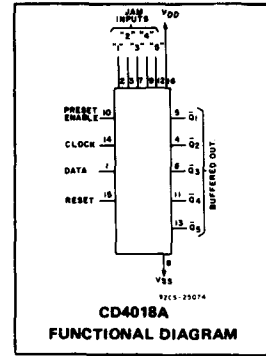

Fig. 1 - Logic diagram.

("DATA" INPUT TIED TO  $\bar{Q}_5$  FOR DECADE COUNTER CONFIGURATION)

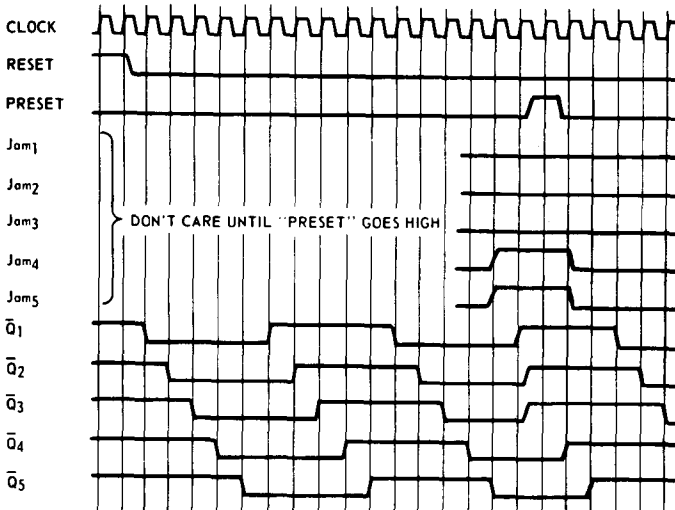

Fig. 2 - Timing diagram.

92SS-4148R2

**Features:**

- Medium speed operation . . . 5 MHz (typ.) at  $V_{DD} - V_{SS} = 10\text{ V}$
- Fully static operation
- Quiescent current specified to 15 V
- Maximum input leakage current of 1  $\mu\text{A}$  at 15 V (full package-temperature range)
- 1-V noise margin (full package-temperature range)

**Applications:**

- Fixed and programmable divide-by-10, 9, 8, 7, 6, 5, 4, 3, 2 counters
- Fixed and programmable counters greater than 10
- Programmable decade counters
- Divide-by-"N" counters/frequency synthesizers
- Frequency division
- Counter control/timers

**EXTERNAL CONNECTIONS FOR DIVIDE BY 10, 9, 8, 7, 6, 5, 4, 3 OPERATION**

DIVIDE BY 10  $\bar{Q}_5$   
 DIVIDE BY 8  $\bar{Q}_4$  CONNECTED BACK TO "DATA" } NO EXTERNAL COMPONENTS REQUIRED  
 DIVIDE BY 6  $\bar{Q}_3$   
 DIVIDE BY 4  $\bar{Q}_2$   
 DIVIDE BY 2  $\bar{Q}_1$

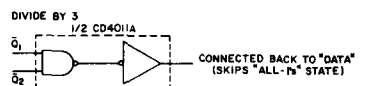
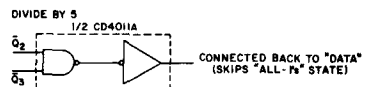
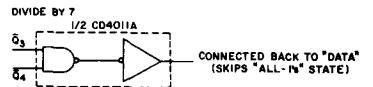
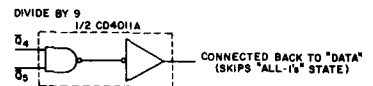

Fig. 3 - External connections for divide by 10, 9, 8, 7, 6, 5, 4, 3, 2 operation.

# CD4018A Types

## MAXIMUM RATINGS, Absolute-Maximum Values:

STORAGE-TEMPERATURE RANGE ( $T_{stg}$ )	-85 to +150°C
OPERATING-TEMPERATURE RANGE ( $T_A$ ):	
PACKAGE TYPES D, F, K, H	-55 to +125°C
PACKAGE TYPE E	-40 to +85°C
DC SUPPLY-VOLTAGE RANGE, ( $V_{DD}$ )	
(Voltages referenced to $V_{SS}$ Terminal):	-0.5 to +15 V
POWER DISSIPATION PER PACKAGE ( $P_D$ )	
FOR $T_A = -40$ to $+60^\circ\text{C}$ (PACKAGE TYPE E)	500 mW
FOR $T_A = +60$ to $+85^\circ\text{C}$ (PACKAGE TYPE E)	Derate Linearly at 12 mW/°C to 200 mW
FOR $T_A = -55$ to $+100^\circ\text{C}$ (PACKAGE TYPES D, F, K)	500 mW
FOR $T_A = +100$ to $+125^\circ\text{C}$ (PACKAGE TYPES D, F, K)	Derate Linearly at 12 mW/°C to 200 mW
DEVICE DISSIPATION PER OUTPUT TRANSISTOR	
FOR $T_A =$ FULL PACKAGE-TEMPERATURE RANGE (ALL PACKAGE TYPES)	100 mW
INPUT VOLTAGE RANGE, ALL INPUTS	-0.5 to $V_{DD} + 0.5$ V
LEAD TEMPERATURE (DURING SOLDERING):	
At distance 1/16 ± 1/32 inch (1.59 ± 0.79 mm) from case for 10 s max.	+265°C

## DYNAMIC ELECTRICAL CHARACTERISTICS at $T_A = 25^\circ\text{C}$ , Input $t_r, t_f = 20$ ns, $C_L = 15$ pF, $R_L = 200$ k $\Omega$

CHARACTERISTIC	TEST CONDITIONS	LIMITS						UNITS	
		VDD (V)	D, F, K, H Packages			E Package			
			Min.	Typ.	Max.	Min.	Typ.		Max.
<b>CLOCKED OPERATION</b>									
Propagation Delay Time; $t_{PLH}, t_{PHL}$ To $\bar{Q}_5$ Output	5	-	350	1000	-	350	1300	ns	
	10	-	125	250	-	125	300		
To Other Outputs	5	-	500	1200	-	500	1600	ns	
	10	-	200	400	-	200	500		
Transition Time; $t_{THL}, t_{TLH}$ To $\bar{Q}_5$ Output	5	-	100	300	-	100	350	ns	
	10	-	50	150	-	50	200		
To Other Outputs	5	-	300	900	-	300	1200	ns	
	10	-	125	350	-	125	450		
Maximum Clock Input Frequency, $f_{CL}$	5	1	2.5	-	0.6	2.5	-	MHz	
	10	3	5	-	2	5	-		
Min. Clock Pulse Width, $t_W$	5	-	200	500	-	200	830	ns	
	10	-	100	170	-	100	250		
Clock Rise & Fall Time; $t_{rCL}, t_{fCL}$	5	-	-	15	-	-	15	$\mu\text{s}$	
	10	-	-	15	-	-	15		
Min. Data Input Set-Up Time, $t_S$	5	-	175	500	-	175	700	ns	
	10	-	75	200	-	75	300		
Average Input Capacitance, $C_I$	Any Input	-	5	-	-	5	-	pF	
<b>PRESET* OR RESET OPERATION</b>									
Propagation Delay Time; $t_{PLH}, t_{PHL}$ To $\bar{Q}_5$ Output	5	-	350	1000	-	350	1300	ns	
	10	-	125	250	-	125	300		
To Other Outputs	5	-	500	1200	-	500	1600	ns	
	10	-	200	400	-	200	500		
Min. Preset or Reset Pulse Width $t_W$	5	-	200	500	-	200	830	ns	
	10	-	100	165	-	100	250		
Min. Preset or Reset Removal Time	5	-	300	750	-	300	1000	ns	
	10	-	100	225	-	100	275		

\* At PRESET ENABLE OR JAM Inputs.

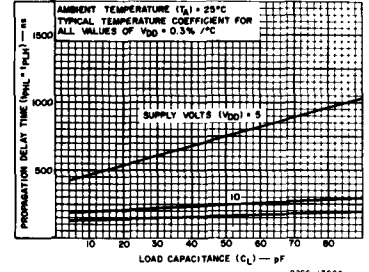

Fig. 4 - Typical propagation delay time vs. load capacitance for decoded outputs.

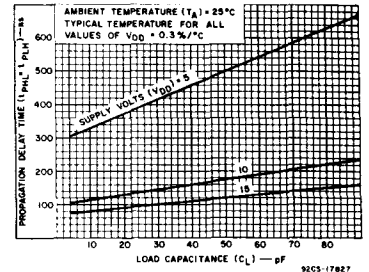

Fig. 5 - Typical propagation delay time vs. load capacitance for  $\bar{Q}_5$  output.

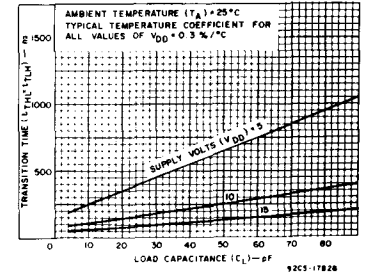

Fig. 6 - Typical transition time vs. load capacitance for decoded outputs.

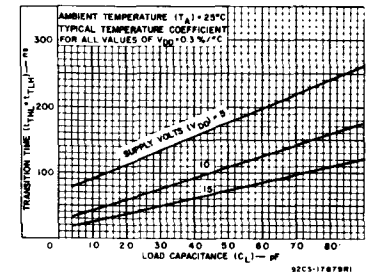

Fig. 7 - Typical transition time vs. load capacitance for  $\bar{Q}_5$  output.

# CD4018A Types

**RECOMMENDED OPERATING CONDITIONS** at  $T_A = 25^\circ\text{C}$ , Except as Noted.  
**For maximum reliability, nominal operating conditions should be selected so that operation is always within the following ranges:**

CHARACTERISTIC	VDD (V)	LIMITS				UNITS
		D, F, K, H Packages		E Package		
		Min.	Max.	Min.	Max.	
Supply-Voltage Range (For $T_A = \text{Full Package-Temperature Range}$ )		3	12	3	12	V
Data Setup Time, $t_S$	5 10	500 200	—	700 300	—	ns
Clock Pulse Width, $t_W$	5 10	500 170	—	830 250	—	ns
Clock Input Frequency, $f_{CL}$	5 10	dc dc	1 3	dc dc	0.6 2	MHz
Clock Rise and Fall Time, $t_{rCL}$ , $t_{fCL}$	5 10	— —	15 15	— —	15 15	$\mu\text{s}$
Preset or Reset Pulse Width, $t_W$	5 10	500 165	—	830 250	—	ns
Preset or Reset Removal Time	5 10	750 225	—	1000 275	—	ns

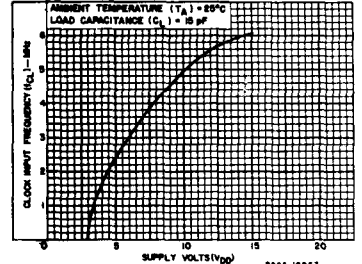

Fig. 8 - Typical maximum input clock frequency vs. supply voltage.

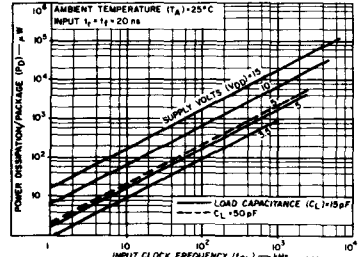

Fig. 9 - Typical dissipation characteristics.

## STATIC ELECTRICAL CHARACTERISTICS

Characteristic	Conditions			Limits at Indicated Temperatures ( $^\circ\text{C}$ )								Units	
				D, F, K, H Packages				E Package					
	V <sub>O</sub> (V)	V <sub>IN</sub> (V)	V <sub>DD</sub> (V)	-55	+25	+125	-40	+25	+85				
Quiescent Device Current $I_Q$ Max.	—	—	5	5	0.3	5	300	50	0.5	50	700	$\mu\text{A}$	
	—	—	10	10	0.5	10	600	100	1	100	1400		
	—	—	15	50	1	50	2000	500	5	500	5000		
Output Voltage: Low Level, $V_{OL}$	—	5	5	0 Typ.; 0.05 Max.								V	
	—	10	10	0 Typ.; 0.05 Max.									
High Level, $V_{OH}$	—	0	5	4.95 Min.; 5 Typ.								V	
	—	0	10	9.95 Min.; 10 Typ.									
Noise Immunity: Inputs Low, $V_{NL}$	4.2	—	5	1.5 Min.; 2.25 Typ.								V	
	9	—	10	3 Min.; 4.5 Typ.									
Inputs High, $V_{NH}$	0.8	—	5	1.5 Min.; 2.25 Typ.								V	
	1	—	10	3 Min.; 4.5 Typ.									
Noise Margin: Inputs Low, $V_{NML}$	4.5	—	5	1 Min.								V	
	9	—	10	1 Min.									
Inputs High, $V_{NMH}$	0.5	—	5	1 Min.								V	
	1	—	10	1 Min.									
Output Drive Current: n-Channel (Sink) $I_{DN}$ Min.	$\bar{Q}_5$	0.5	—	5	0.18	0.4	0.15	0.105	0.095	0.4	0.08	0.085	mA
		0.5	—	10	0.45	1	0.35	0.25	0.3	1	0.25	0.2	
	$Q_1, Q_2$	0.5	—	5	0.06	0.1	0.05	0.035	0.03	0.1	0.025	0.02	
	$Q_3, Q_4$	0.5	—	10	0.25	0.4	0.2	0.14	0.18	0.4	0.15	0.12	
p-Channel (Source) $I_{DP}$ Min.	$\bar{Q}_5$	4.5	—	5	-0.185	-0.4	-0.15	-0.105	-0.095	-0.4	-0.08	-0.065	mA
		9.5	—	10	-0.45	-1	-0.35	-0.25	-0.3	-1	-0.25	-0.2	
	$Q_1, Q_2$	4.5	—	5	-0.075	-0.15	-0.06	-0.04	-0.035	-0.15	-0.03	-0.024	
	$Q_3, Q_4$	9.5	—	10	-0.25	-0.4	-0.2	-0.14	-0.18	-0.4	-0.15	-0.12	
Input Leakage Current, $I_{IL}$ , $I_{IH}$ Max.	Any Input			$\pm 10^{-5}$ Typ., $\pm 1$ Max.								$\mu\text{A}$	

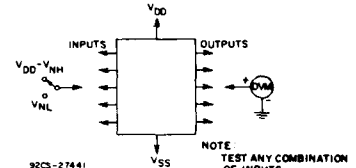

Fig. 10 - Noise-immunity test circuit.

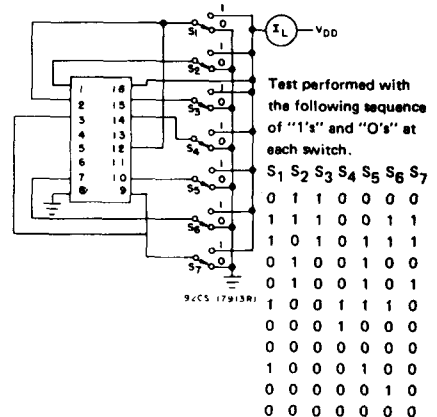

Fig. 11 - Quiescent-device-current test circuit.

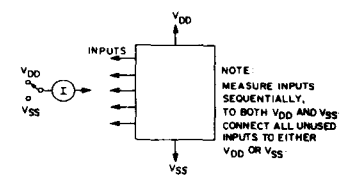

Fig. 12 - Input-leakage-current test circuit.

# CD4019A Types

## CMOS Quad AND/OR Select Gate

The RCA-CD4019A types are comprised of four AND/OR select gate configurations, each consisting of two 2-input AND gates driving a single 2-input OR gate. Selection is accomplished by control bits  $K_A$  and  $K_B$ . In addition to selection of either channel A or channel B information, the control bits can be applied simultaneously to accomplish the logical  $A + B$  function.

These types are supplied in 16-lead hermetic dual-in-line ceramic packages (D and F suffixes), 16-lead dual-in-line plastic package (E suffix), 16-lead ceramic flat packages (K suffix), and in chip form (H suffix).

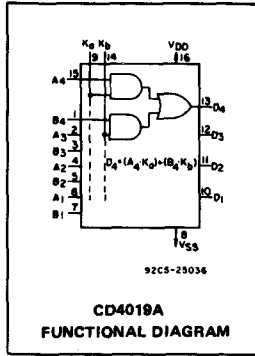

### MAXIMUM RATINGS, Absolute-Maximum Values:

STORAGE-TEMPERATURE RANGE ( $T_{stg}$ )	-65 to +150°C
OPERATING-TEMPERATURE RANGE ( $T_A$ ):	
PACKAGE TYPES D, F, K, H	-55 to +125°C
PACKAGE TYPE E	-40 to +85°C
DC SUPPLY-VOLTAGE RANGE, ( $V_{DD}$ )	
(Voltages referenced to $V_{SS}$ Terminal):	-0.5 to +15 V
POWER DISSIPATION PER PACKAGE ( $P_D$ )	
FOR $T_A = -40$ to +60°C (PACKAGE TYPE E)	.500 mW
FOR $T_A = +60$ to +85°C (PACKAGE TYPE E)	Derate Linearly at 12 mW/°C to 200 mW
FOR $T_A = -55$ to +100°C (PACKAGE TYPES D, F, K)	.500 mW
FOR $T_A = +100$ to +125°C (PACKAGE TYPES D, F, K)	Derate Linearly at 12 mW/°C to 200 mW
DEVICE DISSIPATION PER OUTPUT TRANSISTOR	
FOR $T_A =$ FULL PACKAGE-TEMPERATURE RANGE (ALL PACKAGE TYPES)	100 mW
INPUT VOLTAGE RANGE, ALL INPUTS	-0.5 to $V_{DD} + 0.5$ V
LEAD TEMPERATURE (DURING SOLDERING):	
At distance 1/16 ± 1/32 inch (1.59 ± 0.79 mm) from case for 10 s max	+265°C

### RECOMMENDED OPERATING CONDITIONS

For maximum reliability, nominal operating conditions should be selected so that operation is always within the following ranges:

CHARACTERISTIC	$V_{DD}$ (V)	LIMITS				UNITS
		D, F, K, H Packages		E Package		
		Min.	Max.	Min.	Max.	
Supply-Voltage Range (For $T_A =$ Full Package-Temperature Range)		3	12	3	12	

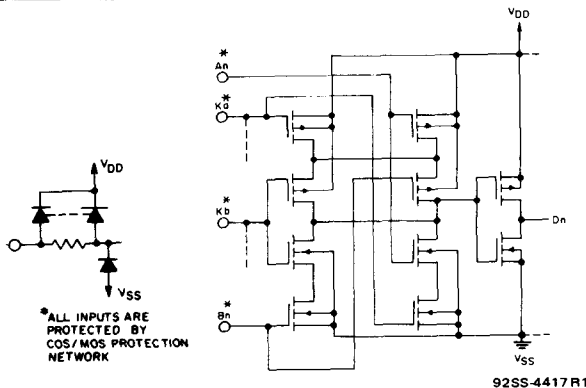

Fig. 1 - Schematic diagram for 1 of 4 identical stages.

### Features:

- Medium-speed operation . . . . .
- ...  $t_{pHL} = t_{pLH} = 50$  ns (typ.) at  $C_L = 15$  pF,  $V_{DD} = 10$  V
- Quiescent current specified to 15 V
- Maximum input leakage current of 1  $\mu$ A at 15 V (full package-temperature range)
- 1-V noise margin (full package-temperature range)

### Applications:

- AND/OR select gating
- Shift-right/shift-left registers
- True/complement selection
- AND/OR/Exclusive-OR selection

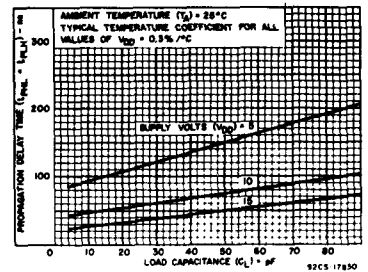

Fig. 2 - Typical propagation delay time vs. load capacitance.

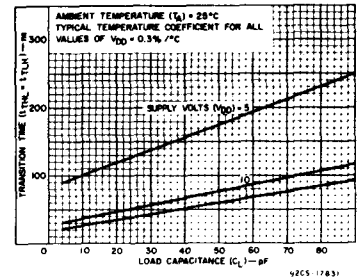

Fig. 3 - Typical transition time vs. load capacitance.

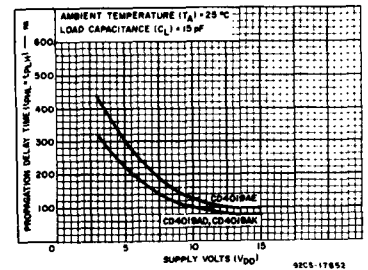

Fig. 4 - Maximum propagation delay time vs. supply voltage.

# CD4019A Types

## STATIC ELECTRICAL CHARACTERISTICS

Characteristic	Conditions			Limits at Indicated Temperatures (°C)								Units
				D, F, K, H Packages				E Package				
	V <sub>O</sub> (V)	V <sub>IN</sub> (V)	V <sub>DD</sub> (V)	-55	+25		+125	-40	+25		+85	
Quiescent Device Current, I <sub>L</sub> Max.	-	-	5	5	0.03	5	300	50	0.1	50	700	μA
	-	-	10	10	0.05	10	600	100	0.2	100	1400	
Output Voltage: Low-Level, V <sub>OL</sub>	-	5	5	0 Typ.; 0.05 Max.								V
	-	10	10	0 Typ.; 0.05 Max.								
High Level V <sub>OH</sub>	-	0	5	4.95 Min.; 5 Typ.								V
	-	0	10	9.95 Min.; 10 Typ.								
Noise Immunity: Inputs Low, V <sub>NL</sub>	3.6	-	5	1.5 Min.; 2.25 Typ.								V
	7.2	-	10	3 Min.; 4.5 Typ.								
Inputs High V <sub>NH</sub>	1.4	-	5	1.5 Min.; 2.25 Typ.								V
	2.8	-	10	3 Min.; 4.5 Typ.								
Noise Margin: Inputs Low, V <sub>NML</sub>	4.5	-	5	1 Min.								V
	9	-	10	1 Min.								
Inputs High, V <sub>NMH</sub>	0.5	-	5	1 Min.								V
	1	-	10	1 Min.								
Output Drive Current: n-Channel (Sink) I <sub>DN</sub> Min.	0.5	-	5	0.6	0.9	0.45	0.3	0.37	1	0.3	0.23	mA
	0.5	-	10	0.9	1.5	0.75	0.55	0.8	1.5	0.65	0.5	
p-Channel (Source): I <sub>DP</sub> Min.	4.5	-	5	-0.31	-0.5	-0.25	-0.175	-0.145	-0.5	-0.12	-0.095	mA
	9.5	-	10	-0.95	-1.5	-0.7	-0.5	-0.6	-1.5	-0.5	-0.4	
Input Leakage Current, I <sub>IL</sub> , I <sub>IH</sub>	Any Input	-	15	±10 <sup>-5</sup> Typ., ±1 Max.								μA

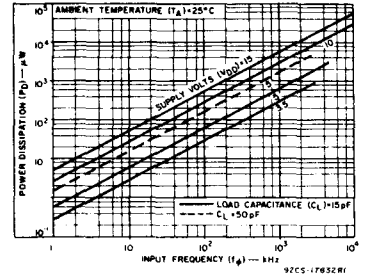

Fig. 5 - Typical dissipation characteristics. (per output).

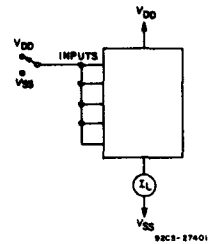

Fig. 6 - Quiescent-device-current test circuit.

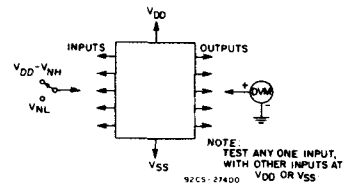

Fig. 7 - Noise-immunity test circuit.

DYNAMIC ELECTRICAL CHARACTERISTICS at T<sub>A</sub> = 25°C, Input t<sub>r</sub>, t<sub>f</sub> = 20 ns, C<sub>L</sub> = 15 pF, R<sub>L</sub> = 200 kΩ

CHARACTERISTIC	TEST CONDITIONS	LIMITS						UNITS	
		D, F, K, H Packages			E Package				
		V <sub>DD</sub> (V)	Min.	Typ.	Max.	Min.	Typ.		Max.
Propagation Delay Time; t <sub>PLH</sub> , t <sub>PHL</sub>		5	-	100	225	-	100	300	ns
		10	-	50	100	-	50	125	
Transition Time; t <sub>THL</sub> , t <sub>TLH</sub>		5	-	100	200	-	100	275	ns
		10	-	40	65	-	40	80	
Average Input Capacitance, C <sub>i</sub>	All A and B Inputs	-	5	-	-	5	-	pF	
	K <sub>a</sub> and K <sub>b</sub> Inputs	-	12	-	-	12	-	pF	

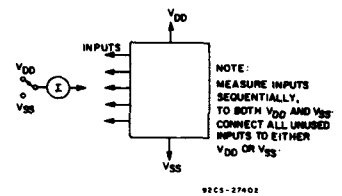

Fig. 8 - Input-leakage-current test circuit.

# CD4020A Types

## CMOS 14-Stage Ripple-Carry Binary Counter/Divider

The RCA-CD4020 consists of a PULSE INPUT shaping circuit, RESET line driver circuitry, and 14 ripple-carry binary counter stages. Buffered outputs are externally available from stages 1 and 4 through 14. The

counter is reset to its all-zeroes state by a high level on the RESET inverter input line. Each counter stage is a static master-slave flip-flop. The counter is advanced one count on the negative-going transition of each INPUT PULSE.

These types are supplied in 16-lead hermetic dual-in-line ceramic packages (D and F suffixes), 16-lead dual-in-line plastic package (E suffix), 16-lead ceramic flat package (K suffix), and in chip form (H suffix).

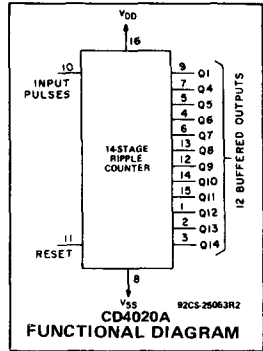

### MAXIMUM RATINGS, Absolute-Maximum Values:

STORAGE-TEMPERATURE RANGE ( $T_{stg}$ )	-65 to +150°C
OPERATING-TEMPERATURE RANGE ( $T_A$ ):	
PACKAGE TYPES D, F, K, H	-55 to +125°C
PACKAGE TYPE E	-40 to +85°C
DC SUPPLY-VOLTAGE RANGE, ( $V_{DD}$ ) (Voltages referenced to $V_{SS}$ Terminal)	-0.5 to +15 V
POWER DISSIPATION PER PACKAGE ( $P_D$ ):	
FOR $T_A = -40$ to $+60^\circ\text{C}$ (PACKAGE TYPE E)	500 mW
FOR $T_A = +60$ to $+85^\circ\text{C}$ (PACKAGE TYPE E)	Derate Linearly at 12 mW/°C to 200 mW
FOR $T_A = -55$ to $+100^\circ\text{C}$ (PACKAGE TYPES D, F, K)	500 mW
FOR $T_A = +100$ to $+125^\circ\text{C}$ (PACKAGE TYPES D, F, K)	Derate Linearly at 12 mW/°C to 200 mW
DEVICE DISSIPATION PER OUTPUT TRANSISTOR	
FOR $T_A = \text{FULL PACKAGE-TEMPERATURE RANGE (ALL PACKAGE TYPES)}$	100 mW
INPUT VOLTAGE RANGE, ALL INPUTS	-0.5 to $V_{DD} + 0.5$ V
LEAD TEMPERATURE (DURING SOLDERING):	
At distance $1/16 \pm 1/32$ inch ( $1.59 \pm 0.79$ mm) from case for 10 s max.	+265°C

**RECOMMENDED OPERATING CONDITIONS at  $T_A = 25^\circ\text{C}$ , Except as Noted.**  
For maximum reliability, nominal operating conditions should be selected so that operation is always within the following ranges:

CHARACTERISTIC	$V_{DD}$ (V)	LIMITS				UNITS
		D, F, K, H Packages		E Package		
		Min.	Max.	Min.	Max.	
Supply-Voltage Range (For $T_A = \text{Full Package-Temperature Range}$ )		3	12	3	12	V
Input Pulse Width, $t_W$	5	335	—	500	—	ns
	10	125	—	165	—	
Input Pulse Frequency, $f_\phi$	5	dc	1.5	dc	1.5	MHz
	10	dc	4	dc	4	
Input Pulse Rise or Fall Time, $t_r, t_f$	5	—	15	—	15	$\mu\text{s}$
	10	—	15	—	15	
Reset Pulse Width, $t_W$	5	2500	—	3000	—	ns
	10	475	—	550	—	

### Features:

- Medium speed operation . . . 7 MHz (typ.) at  $V_{DD} - V_{SS} = 10$  V
- Low output impedance
- Common reset
- Fully static operation
- Quiescent current specified to 15 V
- Maximum input leakage current of  $1 \mu\text{A}$  at 15 V (full package-temperature range)
- 1-V noise margin (full package-temperature range)

### Applications:

- Frequency-dividing circuits
- Time-delay circuits
- Counter control
- Counting functions

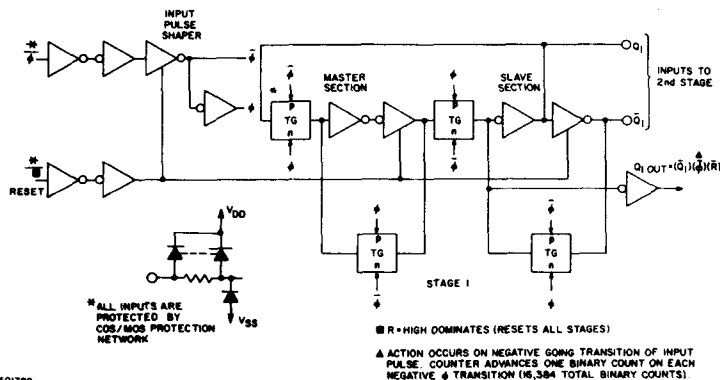

Fig. 1—Logic diagram for 1 of 14 binary stages.

# CD4020A Types

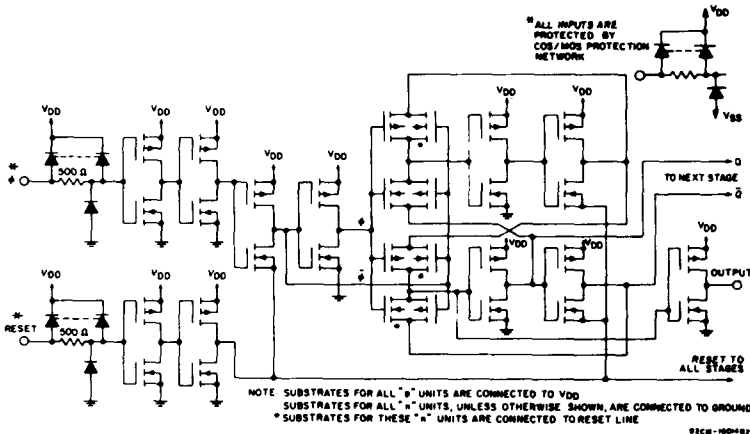

Fig. 2 - Schematic diagram of pulse shapers and 1 of 14 binary stages.

## STATIC ELECTRICAL CHARACTERISTICS

Characteristic	Conditions			Limits at Indicated Temperatures (°C)								Units
				D, F, K, H Packages				E Package				
	V <sub>O</sub> (V)	V <sub>IN</sub> (V)	V <sub>DD</sub> (V)	-55	+25		+125	-40	+25		+85	
Quiescent Device Current, I <sub>L</sub> Max.	-	-	5	15	0.5	15	900	50	1	50	700	μA
	-	-	10	25	1	25	1500	100	2	100	1400	
	-	-	15	50	2.5	50	2000	500	5	500	5000	
Output Voltage: Low-Level, V <sub>OL</sub>	-	5	5	0 Typ.; 0.05 Max.								V
	-	10	10	0 Typ.; 0.05 Max.								
	High-Level, V <sub>OH</sub>	-	0	5	4.95 Min.; 5 Typ.							
Noise Immunity: Inputs Low, V <sub>NL</sub>	4.2	-	5	1.5 Min.; 2.25 Typ.								V
	9	-	10	3 Min.; 4.5 Typ.								
	Inputs High, V <sub>NH</sub>	0.8	-	5	1.5 Min.; 2.25 Typ.							
Noise Margin: Inputs Low, V <sub>NML</sub>	4.5	-	5	1 Min.								V
	9	-	10	1 Min.								
	Inputs High, V <sub>NMH</sub>	0.5	-	5	1 Min.							
Output Drive Current: N-Channel (Sink), I <sub>DN</sub> Min.	0.5	-	5	0.09	0.2	0.075	0.05	0.09	0.33	0.08	0.065	mA
	0.5	-	10	0.185	0.4	0.15	0.105	0.16	0.5	0.10	0.10	
P-Channel (Source) I <sub>DP</sub> Min.	4.5	-	5	-0.11	-0.25	-0.09	-0.065	-0.09	-0.25	-0.06	-0.05	mA
	9.5	-	10	-0.25	-0.5	-0.20	-0.14	-0.18	-0.5	-0.15	-0.12	
Input Leakage Current, I <sub>L</sub> , I <sub>IH</sub>	Any Input			±10 <sup>-5</sup> Typ., ±1 Max.								μA

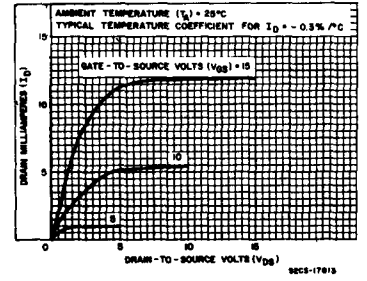

Fig. 3 - Typical output n-channel drain characteristics.

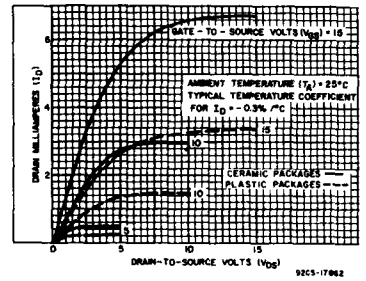

Fig. 4 - Minimum output n-channel drain characteristics.

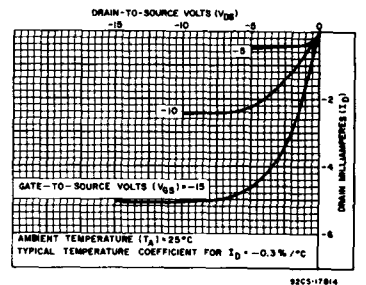

Fig. 5 - Typical output p-channel drain characteristics.

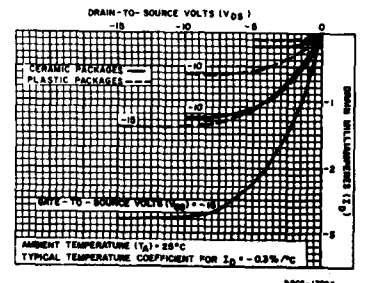

Fig. 6 - Minimum output p-channel drain characteristics.

# CD4020A Types

DYNAMIC ELECTRICAL CHARACTERISTICS at  $T_A = 25^\circ\text{C}$ , Input  $t_r, t_f = 20\text{ ns}$ ,  $C_L = 15\text{ pF}$ ,  $R_L = 200\text{ k}\Omega$

CHARACTERISTIC	TEST CONDITIONS	LIMITS						UNITS
		D, F, K, H Packages			E Package			
		Min.	Typ.	Max.	Min.	Typ.	Max.	
<b>Clocked Operation</b>								
Propagation Delay Time, $t_{PLH}, t_{PHL}$	5	—	450	600	—	450	650	ns
	10	—	150	225	—	150	250	
Transition Time, $t_{THL}, t_{TLH}$	5	—	450	600	—	450	650	ns
	10	—	200	300	—	200	350	
Maximum Input Pulse Frequency, $f_\phi$	5	1.5	2.5	—	1.5	2.5	—	MHz
	10	4	6	—	4	6	—	
Minimum Input Pulse Width, $t_W$	5	—	200	335	—	200	500	ns
	10	—	70	125	—	70	165	
Input Pulse Rise & Fall Time, $t_r, t_f$	5	—	—	15	—	—	15	$\mu\text{s}$
	10	—	—	15	—	—	15	
Average Input Capacitance, $C_I$	Any Input	—	—	5	—	—	5	pF
<b>Reset Operation</b>								
Propagation Delay Time, $t_{PHL}$	5	—	2000	3000	—	2000	3500	ns
	10	—	500	775	—	500	300	
Minimum Reset Pulse Width, $t_W$	5	—	1800	2500	—	1800	3000	ns
	10	—	300	475	—	300	550	

\* Propagation delay is from input pulse to  $Q_1$  output.

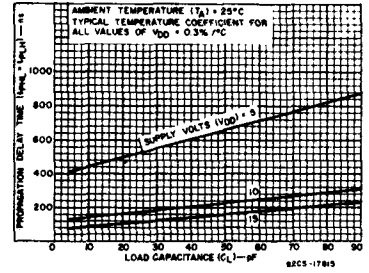

Fig. 7—Typical propagation delay time vs.  $C_L$ .

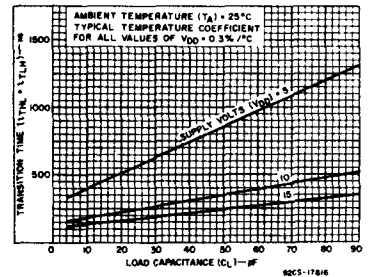

Fig. 8—Typical transition time vs.  $C_L$ .

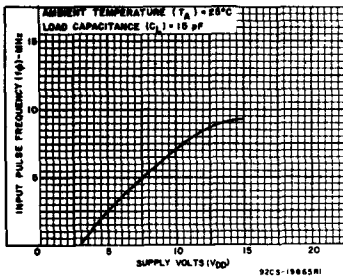

Fig. 9—Typical clock input frequency vs.  $V_{DD}$ .

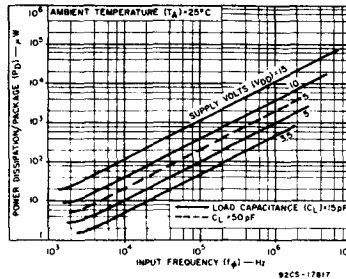

Fig. 10—Typical dissipation characteristics.

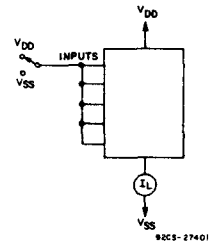

Fig. 11—Quiescent device current test circuit.

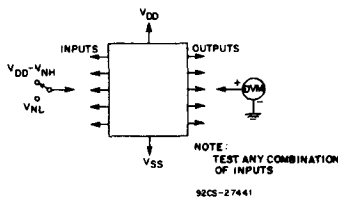

Fig. 12—Noise-immunity test circuit.

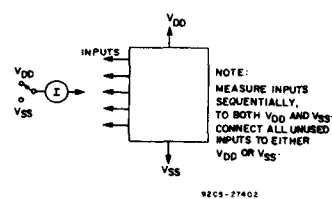

Fig. 13—Input-leakage-current test circuit.



# CMOS 8-Stage Static Shift Register

Asynchronous Parallel Input/Serial Output,  
Synchronous Serial Input/Serial Output

The RCA-CD4021A types are 8-stage parallel or serial-input/serial-output shift registers having common CLOCK and PARALLEL/SERIAL CONTROL inputs, a single SERIAL DATA input, and individual parallel Jam inputs to each register stage. Each register stage is a D-type, master-slave flip-flop. Q outputs are available from the sixth, seventh, and eighth stages.

When the PARALLEL/SERIAL CONTROL input is low, data are serially shifted into the 8-stage register synchronously with the positive-going transition of the CLOCK pulse.

**Features:**

- Asynchronous parallel or synchronous serial operation under control of parallel/serial control input
- Individual JAM inputs to each register stage
- Master-slave flip-flop register stages
- Fully static operation. . . . . DC to 5 MHz
- Quiescent current specified to 15 V
- Maximum input leakage current of 1  $\mu$ A at 15 V (full package-temperature range)
- 1-V noise margin (full package-temperature range)

When the PARALLEL/SERIAL CONTROL input is high, data are jammed into the 8-stage register via the parallel input lines asynchronously with the clock line.

Register expansion is possible using addi-

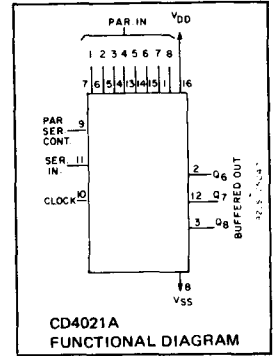

tional CD4021A packages.

These types are supplied in 16-lead hermetic dual-in-line ceramic packages (D and F suffixes), 16-lead dual-in-line plastic package (E suffix), 16-lead ceramic flat package (K suffix), and in chip form (H suffix).

**STATIC ELECTRICAL CHARACTERISTICS**

CHARACTERISTICS	CONDITIONS			LIMITS AT INDICATED TEMPERATURES (°C)								UNITS
	V <sub>O</sub> (V)	V <sub>IN</sub> (V)	V <sub>DD</sub> (V)	D, F, K, H PACKAGES				E PACKAGE				
				-55	+25		+125	-40	+25		+85	
Quiescent Device Current I <sub>L</sub> Max.	-	-	5	5	0.5	5	300	50	0.5	50	700	$\mu$ A
	-	-	10	10	1	10	600	100	1	100	1400	
	-	-	15	50	1	50	2000	500	5	500	5000	
Output Voltage: Low Level, V <sub>OL</sub>	-	5	5	0 Typ.; 0.05 Max.								V
	-	10	10	0 Typ.; 0.05 Max.								
High Level, V <sub>OH</sub>	-	0	5	4.95 Min.; 5 Typ.								V
	-	0	10	9.95 Min.; 10 Typ.								
Noise Immunity: Inputs Low, V <sub>NL</sub>	4.2	-	5	1.5 Min.; 2.25 Typ.								V
	9	-	10	3 Min.; 4.5 Typ.								
Inputs High, V <sub>NH</sub>	0.8	-	5	1.5 Min.; 2.25 Typ.								V
	1	-	10	3 Min.; 4.5 Typ.								
Noise Margin: Inputs Low, V <sub>NML</sub>	4.5	-	5	1 Min.								V
	9	-	10	1 Min.								
Inputs High, V <sub>NMH</sub>	0.5	-	5	1 Min.								V
	1	-	10	1 Min.								
Output Drive Current: N-Channel (Sink), I <sub>D</sub> Min.	0.5	-	5	0.15	0.3	0.12	0.085	0.072	0.3	0.06	0.05	mA
	0.5	-	10	0.31	0.5	0.25	0.175	0.12	0.5	0.1	0.08	
P-Channel (Source), I <sub>D</sub> Min.	4.5	-	5	-0.1	-0.16	-0.08	-0.055	-0.06	-0.16	-0.05	-0.04	mA
	9.5	-	10	-0.25	-0.44	-0.20	-0.14	-0.12	-0.44	-0.1	-0.08	
Input Leakage Current, I <sub>IL</sub> , I <sub>IH</sub>	Any Input											
	-	-	15	$\pm 10^{-5}$ Typ., $\pm 1$ Max.								

**Applications:**

- Parallel to serial data conversion
- Asynchronous parallel input/serial output data queueing
- General purpose register

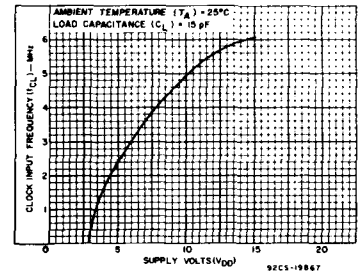

Fig. 1 - Typical clock input frequency vs. supply voltage.

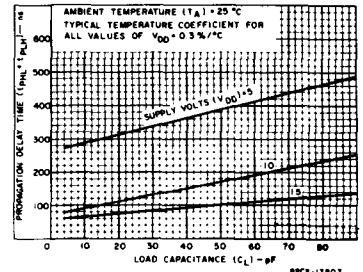

Fig. 2 - Typical propagation delay time vs. load capacitance.

# CD4021A Types

## MAXIMUM RATINGS, Absolute-Maximum Values:

STORAGE-TEMPERATURE RANGE ( $T_{stg}$ )	-55 to +150°C
OPERATING-TEMPERATURE RANGE ( $T_A$ )	
PACKAGE TYPES D, F, K, H	-55 to +125°C
PACKAGE TYPE E	-40 to +85°C
DC SUPPLY-VOLTAGE RANGE, ( $V_{DD}$ )	
(Voltages referenced to $V_{SS}$ Terminal)	-0.5 to +15 V
POWER DISSIPATION PER PACKAGE ( $P_D$ )	
FOR $T_A = -40$ to +60°C (PACKAGE TYPE E)	500 mW
FOR $T_A = +60$ to +85°C (PACKAGE TYPE E)	Derate Linearly at 12 mW/°C to 200 mW
FOR $T_A = -55$ to +100°C (PACKAGE TYPES D, F, K)	500 mW
FOR $T_A = +100$ to +125°C (PACKAGE TYPES D, F, K)	Derate Linearly at 12 mW/°C to 200 mW
DEVICE DISSIPATION PER OUTPUT TRANSISTOR	
FOR $T_A = \text{FULL PACKAGE-TEMPERATURE RANGE (ALL PACKAGE TYPES)}$	100 mW
INPUT VOLTAGE RANGE, ALL INPUTS	-0.5 to $V_{DD} + 0.5$ V
LEAD TEMPERATURE (DURING SOLDERING):	
At distance 1/16 ± 1/32 inch (1.59 ± 0.79 mm) from case for 10 s max.	+265°C

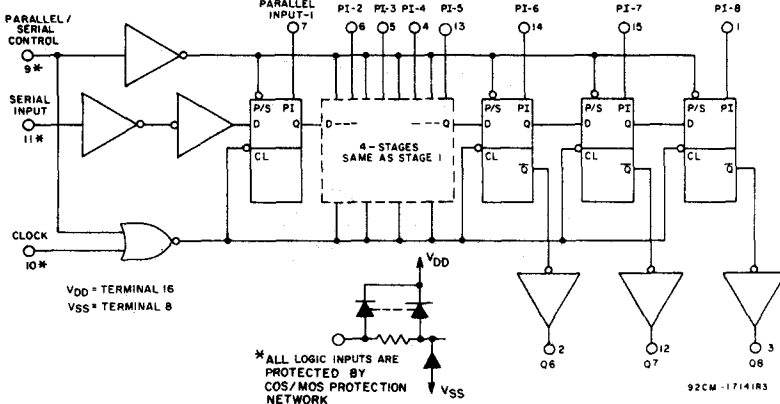

Fig. 5 - Logic diagram.

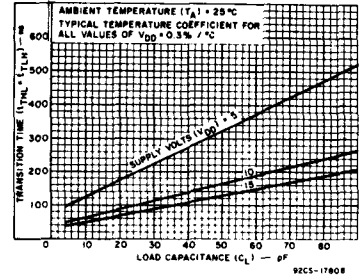

Fig. 3 - Typical transition time vs. load capacitance.

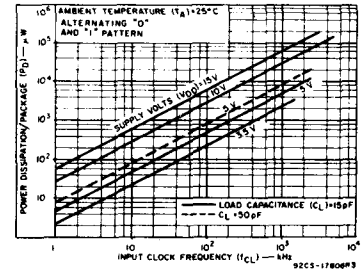

Fig. 4 - Typical dissipation characteristics.

## TRUTH TABLE

$CL^{\Delta}$	Serial Input	Parallel/Serial Control	PI-1	PI-n	$Q_1$ (Internal)	$Q_n$
X	X	1	0	0	0	0
X	X	1	0	1	0	1
X	X	1	1	0	1	0
X	X	1	1	1	1	1
	0	0	X	X	0	$Q_{n-1}$
	1	0	X	X	1	$Q_{n-1}$
	X	0	X	X	$Q_1$	$Q_n$

$\Delta$  = LEVEL CHANGE X = DON'T CARE CASE  
NO CHANGE

92CS-17141R3

Fig. 6 - Truth table.

**RECOMMENDED OPERATING CONDITIONS at  $T_A = 25^\circ\text{C}$ , Except as Noted.**  
For maximum reliability, nominal operating conditions should be selected so that operation is always within the following ranges:

CHARACTERISTIC	$V_{DD}$ (V)	LIMITS				UNITS
		D, F, K, H PACKAGES		E PACKAGE		
		MIN.	MAX.	MIN.	MAX.	
Supply-Voltage Range (For $T_A = \text{Full Package-Temperature Range}$ )		3	12	3	12	V
Data Setup Time, $t_S$	5 10	350 80	-	500 100	-	ns
Clock Pulse Width, $t_{PW}$	5 10	500 175	-	830 200	-	ns
Clock Input Frequency, $f_{CL}$	5 10	dc dc	1 3	dc dc	0.6 2.5	MHz
Clock Rise and Fall Time, $t_{rCL}$ , $t_{fCL}^{\Delta}$	5 10	-	15 5	-	15 5	$\mu\text{s}$

$\Delta$  If more than one unit is cascaded  $t_{fCL}$  should be made less than or equal to the sum of the transition time and the fixed propagation delay of the output of the driving stage for the estimated capacitive load.

# CD4021A Types

## DYNAMIC ELECTRICAL CHARACTERISTICS

at  $T_A = 25^\circ\text{C}$ , Input  $t_r, t_f = 20\text{ ns}$ ,  $C_L = 15\text{ pF}$ ,  $R_L = 200\text{ k}\Omega$

CHARACTERISTIC	TEST CONDITIONS	LIMITS						UNITS
		D, F, K, H PACKAGES			E PACKAGE			
		VDD (V)	MIN.	TYP.	MAX.	MIN.	TYP.	
Propagation Delay Time, $t_{PD}$ $t_{PLH}, t_{PHL}$	5	—	300	750	—	300	1000	ns
	10	—	100	225	—	300	300	
Transition Time; $t_{THL}, t_{TLH}$	5	—	150	300	—	150	400	ns
	10	—	75	125	—	75	150	
Maximum Clock Input Frequency, $f_{CL}$	5	1	2.5	—	0.6	2.5	—	MHz
	10	3	5	—	2.5	5	—	
Minimum Clock Pulse Width, $t_{wP}$	5	—	200	500	—	200	830	ns
	10	—	100	175	—	100	200	
Clock Rise & Fall Time; $t_{rCL} \& t_{fCL}^*$	5	—	—	15	—	—	15	$\mu\text{s}$
	10	—	—	5	—	—	5	
Minimum Data Set Up Time, $t_{S}$	5	—	100	350	—	100	500	ns
	10	—	50	80	—	50	100	
Minimum High-Level Parallel/Serial Control Pulse Width $t_{wP}$	5	—	200	500	—	200	830	ns
	10	—	100	175	—	100	200	
Input Capacitance $C_i$	Any Input	—	5	—	—	5	—	pF

\*If more than one unit is cascaded  $t_{rCL}$  should be made less than or equal to the sum of the transition time and the fixed propagation delay of the output of the driving stage for the estimated capacitive load.

\*\*From Clock or Parallel/Serial Control Input

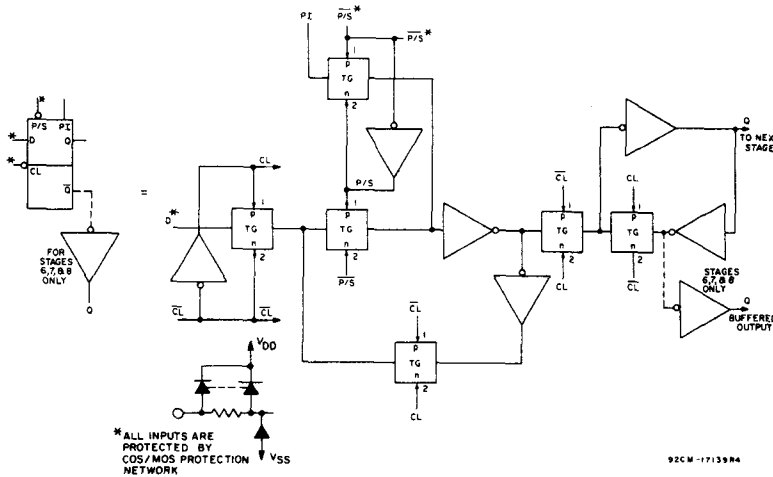

Fig. 10 - One typical stage and its equivalent detailed circuit.

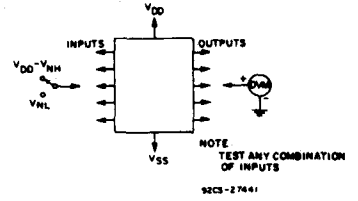

Fig. 7 - Noise-immunity test circuit.

Test performed with the following sequence of "Ones" and "Zeros".

S1 S2 S3 S4 S5  
 0 0 1 0 0  
 1 0 1 1 1  
 1 0 1 0 1  
 0 1 1 1 1  
 0 1 0 0 0

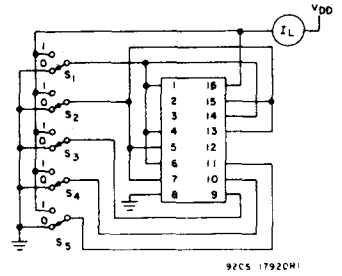

Fig. 8 - Quiescent device current test circuit.

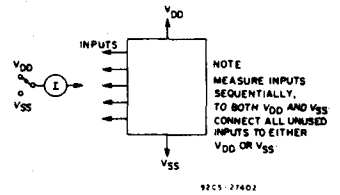

Fig. 9 - Input-leakage-current test circuit.

## CD4022A Types

# CMOS Divide-By-8 Counter/Divider With 8 Decoded Outputs

The RCA-CD4022A types consist of a 4-stage divide-by-8 Johnson counter, associated decode output gating and a CARRY-OUT BIT. The counter is cleared to its zero count by a high RESET signal. The counter is advanced on the positive CLOCK-signal transition provided the CLOCK INHIBIT signal is low.

Use of the Johnson divide-by-8 counter configuration permits high-speed operation, 2-input decode gating, and spike-free decoder outputs. Anti-lock gating is provided, thus assuring proper counting sequence. The 8 decode gating outputs are normally low

and go high only at their respective decoded time slot. Each decode gate output remains high for one full clock cycle. The CARRY-OUT signal completes one cycle every 8 CLOCK-INPUT cycles and is used as a ripple-carry signal to directly clock a succeeding counter package in a multi-package counting system.

These types are supplied in 16-lead hermetic dual-in-line ceramic packages (D and F suffixes), 16-lead dual-in-line plastic package (E suffix), 16-lead ceramic flat package (K suffix), and in chip form (H suffix).

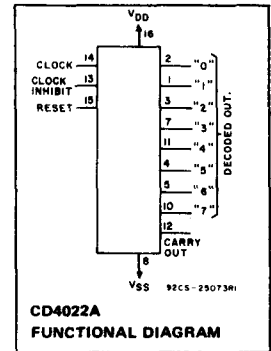

### MAXIMUM RATINGS, Absolute-Maximum Values:

STORAGE-TEMPERATURE RANGE ( $T_{stg}$ )	.....	-65 to +150°C
OPERATING-TEMPERATURE RANGE ( $T_A$ ):		
PACKAGE TYPES D, F, K, H	.....	-55 to +125°C
PACKAGE TYPE E	.....	-40 to +85°C
DC SUPPLY-VOLTAGE RANGE, ( $V_{DD}$ )		
(Voltages referenced to $V_{SS}$ Terminal):	.....	-0.5 to +15 V
POWER DISSIPATION PER PACKAGE ( $P_D$ )		
FOR $T_A = -40$ to +60°C (PACKAGE TYPE E)	.....	500 mW
FOR $T_A = +60$ to +85°C (PACKAGE TYPE E)	.....	Derate Linearly at 12 mW/°C to 200 mW
FOR $T_A = -55$ to +100°C (PACKAGE TYPES D, F, K)	.....	500 mW
FOR $T_A = +100$ to +125°C (PACKAGE TYPES D, F, K)	.....	Derate Linearly at 12 mW/°C to 200 mW
DEVICE DISSIPATION PER OUTPUT TRANSISTOR		
FOR $T_A =$ FULL PACKAGE-TEMPERATURE RANGE (ALL PACKAGE TYPES)	.....	100 mW
INPUT VOLTAGE RANGE, ALL INPUTS	.....	-0.5 to $V_{DD} + 0.5$ V
LEAD TEMPERATURE (DURING SOLDERING):		
At distance 1/16 ± 1/32 inch (1.59 ± 0.79 mm) from case for 10 s max.	.....	+265°C

RECOMMENDED OPERATING CONDITIONS at  $T_A = 25^\circ\text{C}$ , Except as Noted.  
For maximum reliability, nominal operating conditions should be selected so that operation is always within the following ranges:

CHARACTERISTIC	$V_{DD}$ (V)	LIMITS				UNITS
		D, F, K, H Packages		E Package		
		Min.	Max.	Min.	Max.	
Supply-Voltage Range (For $T_A =$ Full Package-Temperature Range)		3	12	3	12	V
Clock Inhibit Setup Time, $t_S$	5 10	175 75	— —	175 75	— —	ns
Clock Pulse Width, $t_W$	5 10	500 170	— —	830 250	— —	ns
Clock Input Frequency, $f_{CL}$	5 10	dc dc	1 3	dc dc	0.6 2	MHz
Clock Rise and Fall Time, $t_{rCL}$ , $t_{fCL}$	5 10	— —	15 15	— —	15 15	$\mu\text{s}$
Reset Pulse Width	5 10	300 150	— —	600 300	— —	ns
Reset Removal Time	5 10	752 225	— —	1000 275	— —	ns

### Features:

- Medium speed operation . . . . 5 MHz (typ.) at  $V_{DD} - V_{SS} = 10$  V
- Divide by N counting; N = 2 to 8 with one CD4022A plus one CD4001A package
- Quiescent current specified to 15 V
- Maximum input leakage current of 1  $\mu\text{A}$  at 15 V (full package-temperature range)
- 1-V noise margin (full package-temperature range)

### Applications:

- Binary counting/decoding
- Binary frequency division
- Binary counter control/timers

# CD4022A Types

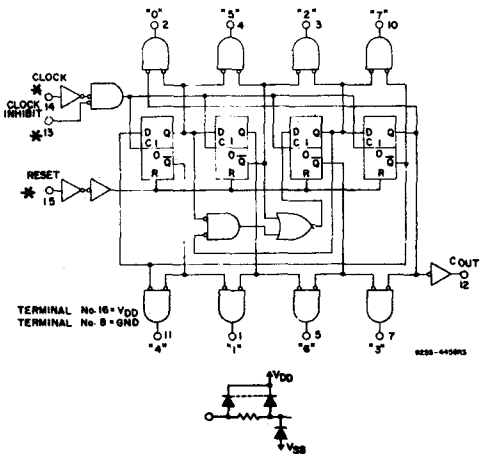

\*ALL INPUTS ARE PROTECTED BY COS/MOS PROTECTION NETWORK

Fig. 1 - Logic diagram.

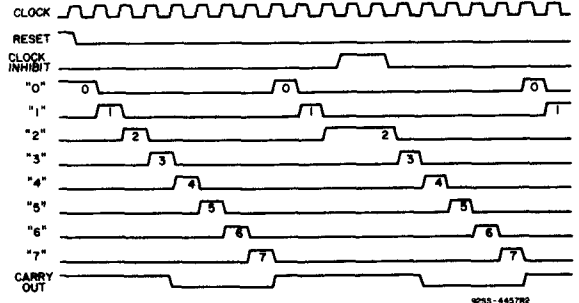

Fig. 2 - Timing diagram.

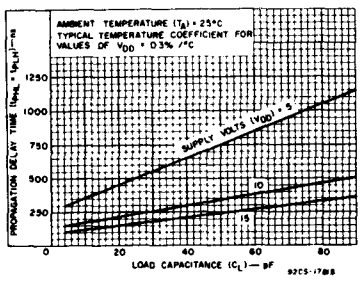

Fig. 3 - Typical propagation delay time vs. load capacitance for decoded outputs.

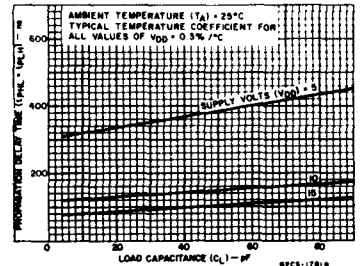

Fig. 4 - Typical propagation delay time vs. load capacitance for carry output.

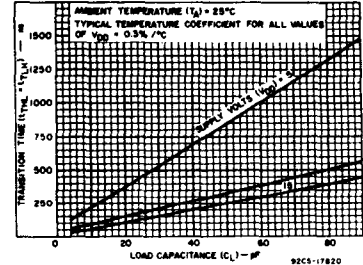

Fig. 5 - Typical transition time vs. load capacitance for decoded outputs.

## STATIC ELECTRICAL CHARACTERISTICS

Characteristic	Conditions			Limits at Indicated Temperatures (°C)								Units	
	V <sub>O</sub> (V)	V <sub>IN</sub> (V)	V <sub>DD</sub> (V)	D, F, K, H Packages				E Package					
				-55	+25		+125	-40	+25		+85		
Quiescent Device Current I <sub>Q</sub> Max.	-	-	5	5	0.3	5	300	60	0.5	50	700	μA	
	-	-	10	10	0.5	10	600	100	1	100	1400		
	-	-	15	50	1	50	2000	500	5	500	5000		
Output Voltage: Low Level V <sub>OL</sub>	-	5	5	0 Typ.; 0.05 Max.								V	
	-	10	10	0 Typ.; 0.05 Max.									
High Level V <sub>OH</sub>	-	0	5	4.96 Min.; 5 Typ.								V	
	-	0	10	9.85 Min.; 10 Typ.									
Noise Immunity: Inputs Low, V <sub>NL</sub>	4.2	-	5	1.5 Min.; 2.25 Typ.								V	
	9	-	10	3 Min.; 4.5 Typ.									
	0.8	-	5	1.5 Min.; 2.25 Typ.									
Inputs High V <sub>NH</sub>	1	-	10	3 Min.; 4.5 Typ.								V	
	4.5	-	5	1 Min.									
Noise Margin: Inputs Low, V <sub>NML</sub>	9	-	10	1 Min.								V	
	0.5	-	5	1 Min.									
Inputs High, V <sub>NMH</sub>	1	-	10	1 Min.								V	
	0.5	-	5	1 Min.									
Output Drive Current: n-Channel (Sink) I <sub>DN</sub> Min.	Decoded Outputs	0.5	-	5	0.062	0.15	0.06	0.036	0.03	0.15	0.025	0.02	mA
		0.5	-	10	0.12	0.3	0.1	0.07	0.06	0.3	0.05	0.04	
	Carry Output	0.5	-	5	0.186	0.5	0.15	0.106	0.096	0.5	0.08	0.066	
		0.5	-	10	0.375	1	0.3	0.21	0.155	1	0.13	0.105	
	Decoded Outputs	4.5	-	5	-0.038	-0.076	-0.03	-0.021	-0.018	-0.075	-0.015	-0.012	
		4.5	-	10	-0.12	-0.15	-0.1	-0.07	-0.06	-0.15	-0.06	-0.04	
Carry Output	4.5	-	5	-0.186	-0.4	-0.15	-0.106	-0.096	-0.4	-0.08	-0.066		
	4.5	-	10	-0.375	-0.8	-0.3	-0.21	-0.155	-0.8	-0.13	-0.105		
Input Leakage Current, I <sub>IL</sub> , I <sub>IH</sub>	Any Input			±10 <sup>-5</sup> Typ., ±1 Max.								μA	
	-	-	15										

# CD4022A Types

DYNAMIC ELECTRICAL CHARACTERISTICS at  $T_A = 25^\circ\text{C}$ , Input  $t_r, t_f = 20\text{ ns}$ ,

$C_L = 15\text{ pF}$ ,  $R_L = 200\text{ k}\Omega$

CHARACTERISTIC	TEST CONDITIONS	LIMITS						UNITS
		D, F, K, H Packages			E Package			
		VDD (V)	Min.	Typ.	Max.	Min.	Typ.	
<b>CLOCKED OPERATION</b>								
Propagation Delay Time: $t_{PHL}, t_{PLH}$ Carry-Out Line	5	—	325	1000	—	325	1300	ns
	10	—	125	250	—	125	500	
Decode Out Lines	5	—	400	1200	—	400	1600	ns
	10	—	200	400	—	200	800	
Transition Time: $t_{THL}, t_{TLH}$ Carry-Out Line	5	—	85	300	—	85	340	ns
	10	—	50	100	—	50	200	
Decode-Out Lines	5	—	300	900	—	300	1200	ns
	10	—	125	250	—	125	500	
Min. Clock Pulse Width, $t_W$	5	—	250	500	—	250	830	ns
	10	—	85	170	—	85	250	
Clock Rise and Fall Time, $t_{rCL}, t_{fCL}$	5	—	—	15	—	—	15	$\mu\text{s}$
	10	—	—	15	—	—	15	
Min. Clock Inhibit Set-Up Time, $t_S$	5	—	175	360	—	175	700	ns
	10	—	75	150	—	75	300	
Max. Clock Input Frequency, $f_{CL}^*$	5	1	2.5	—	0.6	2.5	—	MHz
	10	3	5	—	2	5	—	
Input Capacitance, $C_i$	Any Input	—	5	—	—	5	—	pF
<b>RESET OPERATION</b>								
Propagation Delay Time: $t_{PHL}, t_{PLH}$ Carry-Out Line	5	—	300	900	—	300	1200	ns
	10	—	125	250	—	125	500	
Decode-Out Line	5	—	500	1250	—	500	2500	ns
	10	—	200	400	—	200	800	
Min. Reset Pulse Width, $t_W$	5	—	150	300	—	150	600	ns
	10	—	75	150	—	75	300	
Min. Reset Removal Time	5	—	300	752	—	300	1000	ns
	10	—	100	225	—	100	275	

\* Measured with respect to carry output line

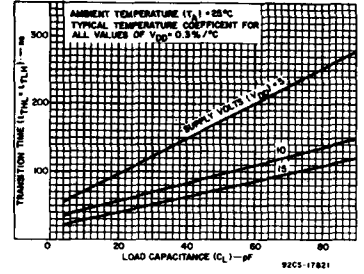

Fig. 6 — Typical transition time vs. load capacitance for carry output.

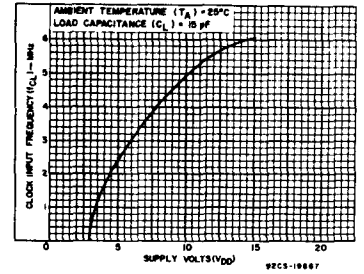

Fig. 7 — Typical clock input frequency vs. supply voltage.

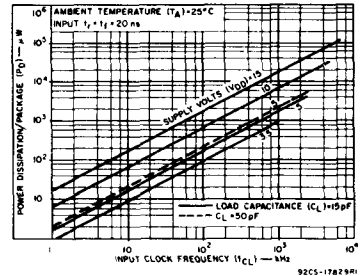

Fig. 8 — Typical dissipation characteristics.

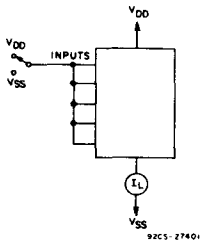

Fig. 9 — Quiescent device current test circuit.

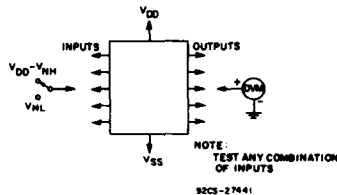

Fig. 10 — Noise immunity test circuit.

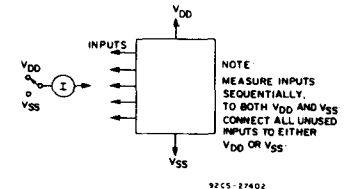

Fig. 11 — Input leakage current test circuit.

# CMOS 7-Stage Binary Counter

With Buffered Reset

The RCA-CD4024A consists of an INPUT PULSE shaping circuit, RESET line driver circuitry, and seven binary counter stages. The counter is reset to "zero" by a high level on the RESET input. Each counter stage is a static master-slave flip-flop. The counter state is advanced one count on the negative-going transition of each INPUT PULSE.

These types are supplied in 14-lead hermetic dual-in-line ceramic packages (D and F suffixes), 14-lead dual-in-line plastic package (E suffix), 12-lead hermetic TO-5-style package (T suffix) 14-lead ceramic flat packages (K suffix), and in chip form (H suffix).

**Applications:**

- Frequency-dividing circuits
- Time-delay circuits
- Counter control
- D/A counter and switch on one chip

**MAXIMUM RATINGS, Absolute-Maximum Values:**

STORAGE-TEMPERATURE RANGE ( $T_{stg}$ )	.....	-65 to +150°C
OPERATING-TEMPERATURE RANGE ( $T_A$ ):		
PACKAGE TYPES (D, F, K, T, H)	.....	-55 to +125°C
PACKAGE TYPE E	.....	-40 to +85°C
DC SUPPLY-VOLTAGE RANGE, ( $V_{DD}$ )		
(Voltages referenced to $V_{SS}$ Terminal):	.....	-0.5 to +15 V
POWER DISSIPATION PER PACKAGE ( $P_D$ )		
FOR $T_A = -40$ to $+80^\circ\text{C}$ (PACKAGE TYPE E)	.....	500 mW
FOR $T_A = +60$ to $+85^\circ\text{C}$ (PACKAGE TYPE E)	.....	Derate Linearly at 12 mW/°C to 200 mW
FOR $T_A = -55$ to $+100^\circ\text{C}$ (PACKAGE TYPES D, F, K, T)	.....	500 mW
FOR $T_A = +100$ to $+125^\circ\text{C}$ (PACKAGE TYPES D, F, K, T)	.....	Derate Linearly at 12 mW/°C to 200 mW
DEVICE DISSIPATION PER OUTPUT TRANSISTOR		
FOR $T_A = \text{FULL PACKAGE-TEMPERATURE RANGE (ALL PACKAGE TYPES)}$	.....	100 mW
INPUT VOLTAGE RANGE, ALL INPUTS	.....	-0.5 to $V_{DD} + 0.5$ V
LEAD TEMPERATURE (DURING SOLDERING):		
At distance 1/16 ± 1/32 inch (1.59 ± 0.79 mm) from case for 10 s max.	.....	+265°C

**RECOMMENDED OPERATING CONDITIONS at  $T_A = 25^\circ\text{C}$ , Except as Noted.**  
 For maximum reliability, nominal operating conditions should be selected so that operation is always within the following ranges.

CHARACTERISTIC	$V_{DD}$ (V)	LIMITS				UNITS
		D, F, K, T, H Packages		E Package		
		Min.	Max.	Min.	Max.	
Supply-Voltage Range (For $T_A = \text{Full Package-Temperature Range}$ )		3	12	3	12	V
Clock Pulse Width, $t_{WP}$	5 10	330 125	—	500 165	—	ns
Clock Input Frequency, $f_{CL}$	5 10	dc	1.5 4	dc	1 3	MHz
Clock Rise or Fall Time, $t_{rCL}$ , $t_{fCL}$	5 10	15 15	—	15 15	—	μs
Reset Pulse Width, $t_{WR}$	5 10	500 300	—	600 350	—	ns

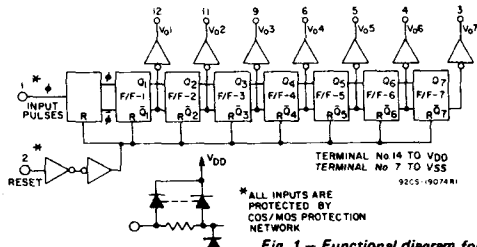

Fig. 1 - Functional diagram for CD4024AD, AE, AF.

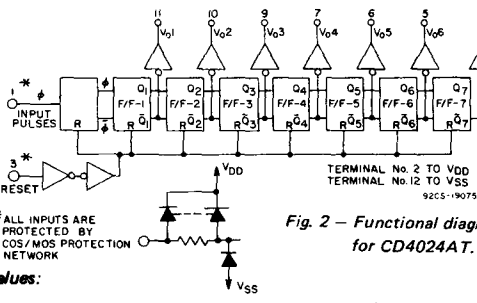
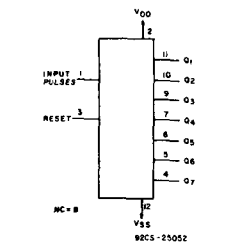
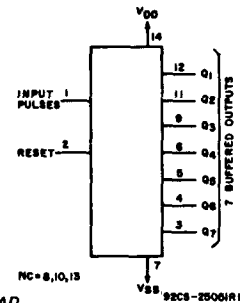

Fig. 2 - Functional diagram for CD4024AT.



**Features:**

- Medium-speed operation . . . . .
- . . . 7-MHz (typ.) input pulse rate at  $V_{DD} - V_{SS} = 10$  V
- Low high-and-low level output impedance . . . 700Ω and 500Ω (typ.), respectively at  $V_{DD} - V_{SS} = 10$  V
- Fully static operation
- Common reset
- Quiescent current specified to 15 V
- Maximum input leakage current of 1 μA at 15 V (full package-temperature)
- 1-V noise margin (full package-temperature range)

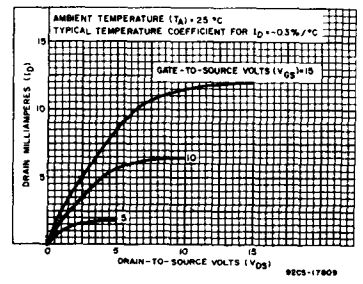

Fig. 3 - Typical output n-channel drain characteristics.

# CD4024A Types

## STATIC ELECTRICAL CHARACTERISTICS

Characteristic	Conditions			Limits at Indicated Temperatures (°C)								Units
				D, F, K, T, H Packages				E Package				
	V <sub>O</sub> (V)	V <sub>IN</sub> (V)	V <sub>DD</sub> (V)	-55	+25		+125	-40	+25		+85	
Quiescent Device Current, I <sub>L</sub> Max.	-	-	5	5	0.3	5	300	50	0.5	50	700	μA
	-	-	10	10	0.5	10	600	100	1	100	1400	
	-	-	15	50	1	50	2000	500	5	500	5000	
Output Voltage: Low-Level, V <sub>OL</sub>	-	5	5	0 Typ.; 0.05 Max.								V
	-	10	10	0 Typ.; 0.05 Max.								
	-	0	5	4.95 Min.; 5 Typ.								
High Level, V <sub>OH</sub>	-	0	10	9.95 Min.; 10 Typ.								V
	-	0	10	9.95 Min.; 10 Typ.								
Noise Immunity: Inputs Low, V <sub>NL</sub>	4.2	-	5	1.5 Min.; 2.25 Typ.								V
	9	-	10	3 Min.; 4.5 Typ.								
Inputs High, V <sub>NH</sub>	0.8	-	5	1.5 Min.; 2.25 Typ.								V
	1	-	10	3 Min.; 4.5 Typ.								
Noise Margin: Inputs Low, V <sub>NML</sub>	4.5	-	5	1 Min.								V
	9	-	10	1 Min.								
Inputs High, V <sub>NMH</sub>	0.5	-	5	1 Min.								V
	1	-	10	1 Min.								
Output Drive Current: n-Channel (Sink), I <sub>DN</sub> Min.	0.5	-	5	0.31	0.5	0.25	0.175	0.15	0.5	0.12	0.095	mA
	0.5	-	10	0.62	1	0.5	0.35	0.31	1	0.25	0.2	
p-Channel (Source) I <sub>DP</sub> Min.	4.5	-	5	-0.19	-0.3	-0.15	-0.105	-0.145	-0.3	-0.12	-0.095	mA
	9.5	-	10	-0.45	-0.7	-0.35	-0.25	-0.31	-0.7	-0.25	-0.2	
Input Leakage Current, I <sub>IL</sub> , I <sub>IH</sub>	Any Input			±10 <sup>-5</sup> Typ.; ±1 Max.								μA

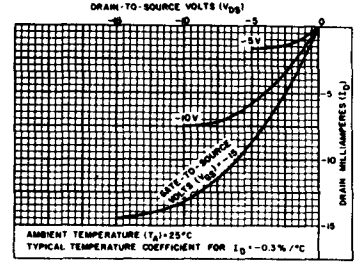

Fig. 4 - Typical output p-channel drain characteristics.

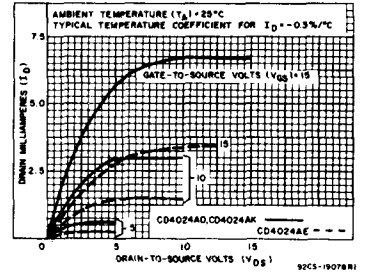

Fig. 5 - Minimum output n-channel drain characteristics.

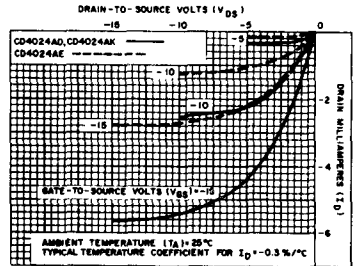
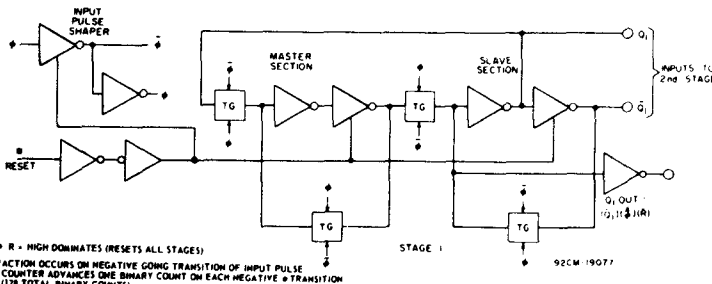

Fig. 6 - Minimum output p-channel drain characteristics.



### EQUATIONS FOR STAGES 2 TO 7

$$\begin{aligned}
 Q_{2OUT} &= (\bar{Q}_2)(Q_1)(\bar{\phi})(\bar{R}) & Q_{5OUT} &= (\bar{Q}_5)(Q_1)(Q_2)(Q_3)(Q_4)(\bar{\phi})(\bar{R}) \\
 Q_{3OUT} &= (\bar{Q}_3)(Q_1)(Q_2)(\bar{\phi})(\bar{R}) & Q_{6OUT} &= (\bar{Q}_6)(Q_1)(Q_2)(Q_3)(Q_4)(Q_5)(\bar{\phi})(\bar{R}) \\
 Q_{4OUT} &= (\bar{Q}_4)(Q_1)(Q_2)(Q_3)(\bar{\phi})(\bar{R}) & Q_{7OUT} &= (\bar{Q}_7)(Q_1)(Q_2)(Q_3)(Q_4)(Q_5)(Q_6)(\bar{\phi})(\bar{R})
 \end{aligned}$$

Fig. 7 - Logic block diagram (pulse shaper and 1 binary stage).

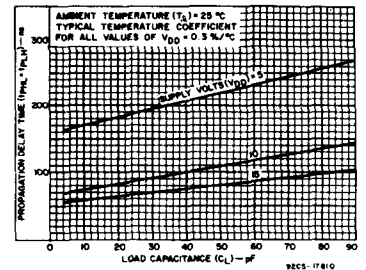

Fig. 8 - Typical propagation delay time vs. C<sub>L</sub>.



# CD4024A Types

DYNAMIC ELECTRICAL CHARACTERISTICS at  $T_A = 25^\circ\text{C}$ , Input  $t_r, t_f = 20\text{ ns}$ ,  
 $C_L = 15\text{ pF}$ ,  $R_L = 200\text{ k}\Omega$

CHARACTERISTIC	TEST CONDITIONS	LIMITS						UNITS	
		VDD (V)	D, F, K, T, H Packages			E Package			
			Min.	Typ.	Max.	Min.	Typ.		Max.
<b><math>\phi</math> INPUT OPERATION</b>									
Propagation Delay Time; <sup>*</sup> $t_{PLH}, t_{PHL}$	5	—	175	350	—	175	400	ns	
	10	—	80	125	—	80	150		
Transition Time; $t_{THL}, t_{TLH}$	5	—	175	225	—	175	250	ns	
	10	—	80	125	—	80	150		
Maximum Pulse Input Frequency, $f_\phi$	5	1.5	2.5	—	1	2.5	—	MHz	
	10	4	7	—	3	7	—		
Minimum Input Pulse Width, $t_W$	5	—	200	330	—	200	500	ns	
	10	—	140	125	—	140	165		
Input Pulse Rise & Fall Time, $t_r, t_f$	5	—	—	15	—	—	15	$\mu\text{s}$	
	10	—	—	10	—	—	10		
Average Input Capacitance, $C_I$	Any Input	—	5	—	—	5	—	pF	
<b>RESET OPERATION</b>									
Propagation Delay Time; $T_{PLH}, T_{PHL}$	5	—	500	700	—	500	800	ns	
	10	—	250	350	—	250	400		
Minimum Reset Pulse Width; $t_W$	5	—	375	500	—	375	600	ns	
	10	—	200	300	—	200	350		

\* Propagation delay time is from input pulse to  $Q_1$  output.

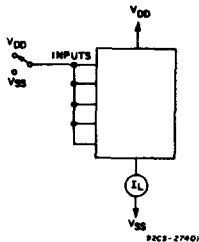

Fig. 12 — Quiescent device current test circuit.

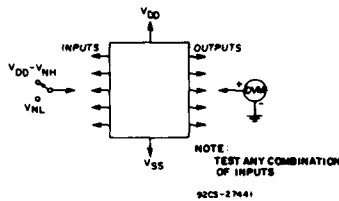

Fig. 13 — Noise immunity test circuit.

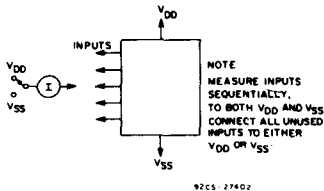

Fig. 14 — Input leakage current test circuit.

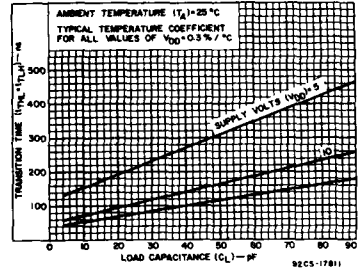

Fig. 9 — Typical transition time vs.  $C_L$ .

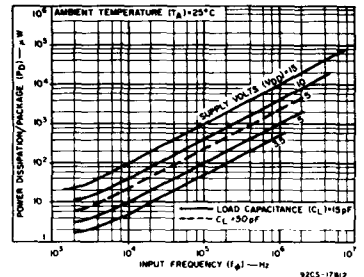

Fig. 10 — Typical dissipation characteristics.

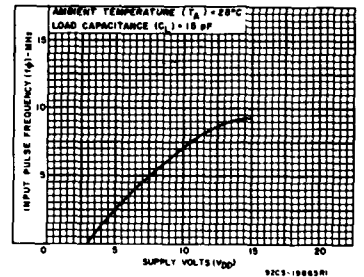

Fig. 11 — Typical input pulse frequency vs.  $V_{DD}$

# CD4026A, CD4033A Types

## CMOS Decade Counters/Dividers

With Decoded 7-Segment Display Outputs and:  
 Display Enable — CD4026A  
 Ripple Blanking — CD4033A

The RCA—CD4026A and CD4033A each consist of a 5-stage Johnson decade counter and an output decoder which converts the Johnson code to a 7-segment decoded output for driving each stage in a numerical display.

These devices are particularly advantageous in display applications where low power dissipation and/or low package count are important.

Inputs common to both types are CLOCK, RESET, & CLOCK INHIBIT; common outputs are CARRY OUT and the seven decoded outputs (a, b, c, d, e, f, g). Additional inputs and outputs for the CD4026A include DISPLAY ENABLE input and DISPLAY ENABLE and UNGATED "C-SEGMENT" outputs. Signals peculiar to the CD4033A are RIPPLE-BLANKING INPUT and LAMP TEST INPUT and a RIPPLE-BLANKING OUTPUT.

A high RESET signal clears the decade counter to its zero count. The counter is advanced one count at the positive clock signal transition if the CLOCK INHIBIT signal is low. Counter advancement via the clock line is inhibited when the CLOCK INHIBIT signal is high. The CLOCK INHIBIT signal can be used as a negative-edge clock if the clock line is held high. Antilock gating is provided on the Johnson counter, thus assuring proper counting sequence. The CARRY-OUT (C<sub>OUT</sub>) signal completes one cycle every ten CLOCK INPUT cycles and is used to clock the succeeding decade directly in a multi-decade counting chain.

The seven decoded outputs (a, b, c, d, e, f, g) illuminate the proper segments in a seven segment display device used for representing the decimal numbers 0 to 9. The 7-segment outputs go high on selection in the CD4033A; in the CD4026A these outputs go high only when the DISPLAY ENABLE IN is high.

### CD4026A

When the DISPLAY ENABLE IN is low the seven decoded outputs are forced low regardless of the state of the counter. Activation of the display only when required results in significant power savings. This system also facilitates implementation of display-character multiplexing.

The CARRY OUT and UNGATED "C-SEGMENT" signals are not gated by the DISPLAY ENABLE and therefore are available continuously. This feature is a requirement in implementation of certain divider functions such as divide-by-60 and divide-by-12.

### CD4033A

The CD4033A has provisions for automatic blanking of the non-significant zeros in a

multi-digit decimal number which results in an easily readable display consistent with normal writing practice. For example, the number 0050.07000 in an eight digit display would be displayed as 50.07. Zero suppression on the integer side is obtained by connecting the RBI terminal of the CD4033A associated with the most significant digit in the display to a low-level voltage and connecting the RBO terminal of that stage to the RBI terminal of the CD4033A in the next-lower significant position in the display. This procedure is continued for each succeeding CD4033A on the integer side of the display.

On the fraction side of the display the RBI of the CD4033A associated with the least significant bit is connected to a low level voltage and the RBO of that CD4033A is connected to the RBI terminal of the CD4033A in the next more-significant-bit position. Again, this procedure is continued for all CD4033A's on the fraction side of the display.

In a purely fractional number the zero immediately preceding the decimal point can be displayed by connecting the RBI of that stage to a high level voltage (instead of to the RBO of the next more-significant-stage). For Example: optional zero → 0.7346. Likewise, the zero in a number such as 763.0 can be displayed by connecting the RBI of the CD4033A associated with it to a high-level voltage.

Ripple blanking of non-significant zeros provides an appreciable savings in display power.

The CD4033A has a LAMP TEST input which, when connected to a high-level voltage, overrides normal decoder operation and enables a check to be made on possible display malfunctions by putting the seven outputs in the high state.

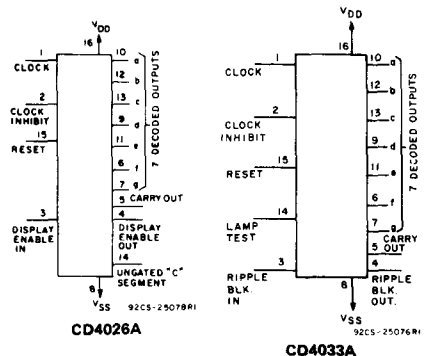

FUNCTIONAL DIAGRAMS

### Features:

- Counter and 7-segment decoding in one package
- Easily interfaced with 7-segment display types
- Fully static counter operation: DC to 2.5 MHz (typ.)
- Ideal for low-power displays
- Display Enable Output (CD4026A)
- "Ripple Blanking" and Lamp Test (CD4033A)
- Quiescent current specified to 15 V
- Maximum input leakage current of 1  $\mu$ A at 15 V (full package-temperature range)
- 1-V noise margin (full package-temperature range)

### Applications:

- Decade counting/7-segment decimal display
- Frequency division/7-segment decimal displays
- Clock/watches/timers (e.g.  $\div 60$ ,  $\div 60$ ,  $\div 12$  counter/display)
- Counter/display driver for meter applications

These types are supplied in 16-lead hermetic dual-in-line ceramic packages (D and F suffixes), 16-lead dual-in-line plastic package (E suffix), 16-lead ceramic flat packages (K suffix), and in chip form (H suffix).

### MAXIMUM RATINGS, Absolute-Maximum Values:

STORAGE-TEMPERATURE RANGE (T <sub>stg</sub> )	.....	-85 to +150°C
OPERATING-TEMPERATURE RANGE (T <sub>A</sub> ):		
PACKAGE TYPES D, F, K, H	.....	-55 to +125°C
PACKAGE TYPE E	.....	-40 to +85°C
DC SUPPLY-VOLTAGE RANGE, (V <sub>DD</sub> )		
(Voltages referenced to V <sub>SS</sub> Terminal):	.....	-0.5 to +15 V
POWER DISSIPATION PER PACKAGE (P <sub>D</sub> )		
FOR T <sub>A</sub> = -40 to +60°C (PACKAGE TYPE E)	.....	500 mW
FOR T <sub>A</sub> = +60 to +85°C (PACKAGE TYPE E)	.....	Derate Linearly at 12 mW/°C to 200 mW
FOR T <sub>A</sub> = -55 to +100°C (PACKAGE TYPES D, F, K)	.....	500 mW
FOR T <sub>A</sub> = +100 to +125°C (PACKAGE TYPES D, F, K)	.....	Derate Linearly at 12 mW/°C to 200 mW
DEVICE DISSIPATION PER OUTPUT TRANSISTOR		
FOR T <sub>A</sub> = FULL PACKAGE-TEMPERATURE RANGE (ALL PACKAGE TYPES)	.....	100 mW
INPUT VOLTAGE RANGE, ALL INPUTS	.....	-0.5 to V <sub>DD</sub> +0.5 V
LEAD TEMPERATURE (DURING SOLDERING):		
At distance 1/16 ± 1/32 inch (1.59 ± 0.79 mm) from case for 10 s max.	.....	+265°C

# CD4026A, CD4033A Types

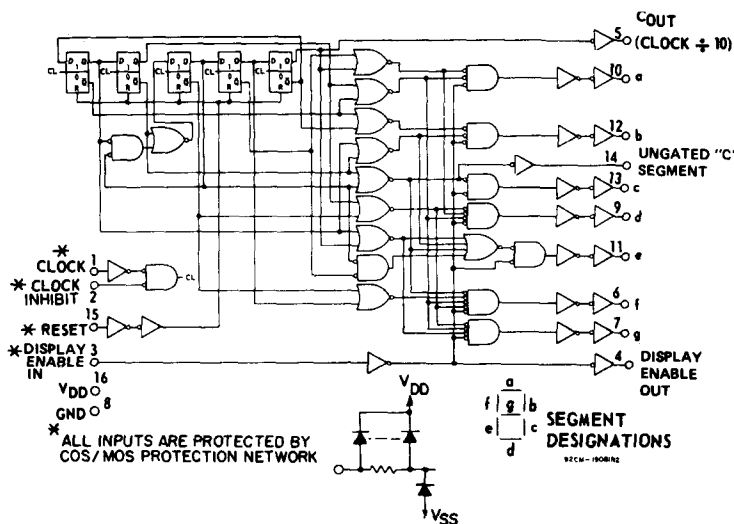

Fig. 1 - CD4026A logic diagram.

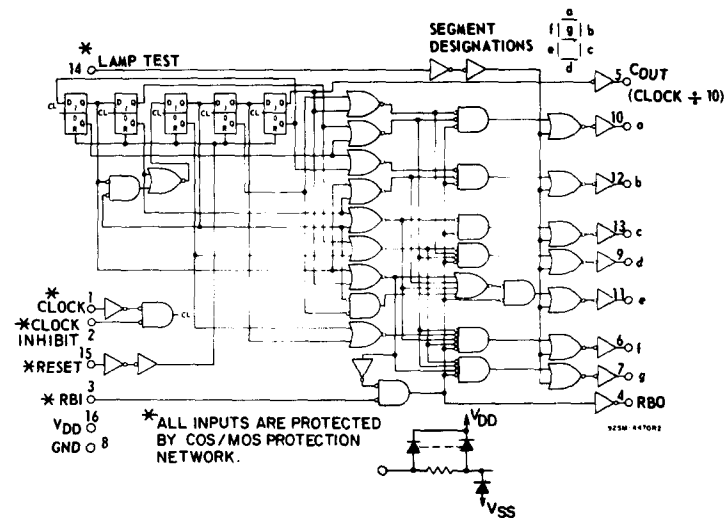

Fig. 3 - CD4033A logic diagram.

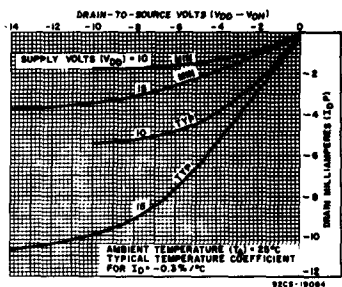

Fig. 6 - Minimum and typical output p-channel decoded drain characteristics @ VDD=10 & 15 V.

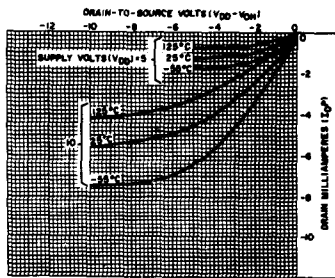

Fig. 7 - Typical output p-channel decoded drain characteristics as a function of temperature.

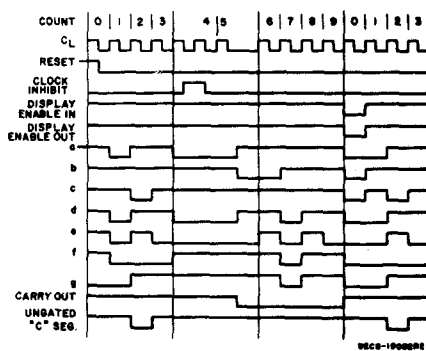

Fig. 2 - CD4026A timing diagram.

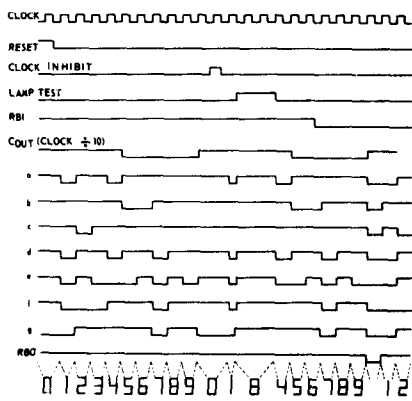

Fig. 4 - CD4033A timing diagram.

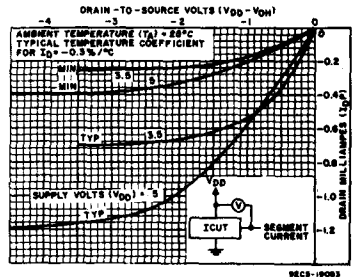

Fig. 5 - Minimum and typical output p-channel decoded drain characteristics @ VDD=3.5 & 5 V.

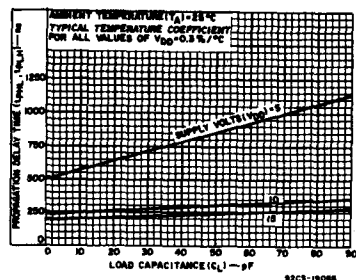

Fig. 8 - Typical propagation delay time vs. C<sub>L</sub> for decoded outputs.

# CD4026A, CD4033A Types

**RECOMMENDED OPERATING CONDITIONS** at  $T_A = 25^\circ\text{C}$ , Except as Noted.  
 For maximum reliability, nominal operating conditions should be selected so that operation is always within the following ranges:

CHARACTERISTIC	V <sub>DD</sub> (V)	LIMITS				UNITS
		D, F, K, H Packages		E Package		
		Min.	Max.	Min.	Max.	
Supply-Voltage Range (For $T_A =$ Full Package-Temperature Range)		3	12	3	12	V
Clock Inhibit Setup Time, $t_S$	5	500	—	700	—	ns
	10	200	—	300	—	
Clock Pulse Width, $t_{WP}$	5	330	—	500	—	ns
	10	170	—	250	—	
Clock Input Frequency, $f_{CL}$	5	dc	1.5	dc	1	MHz
	10	dc	3	dc	2	
Clock Rise or Fall Time, $t_{rCL}$ , $t_{fCL}$	5	—	15	—	15	$\mu\text{s}$
	10	—	15	—	15	
Reset Pulse Width, $t_{WP}$	5	330	—	550	—	ns
	10	165	—	250	—	
Reset Removal Time	5	750	—	1000	—	ns
	10	225	—	275	—	

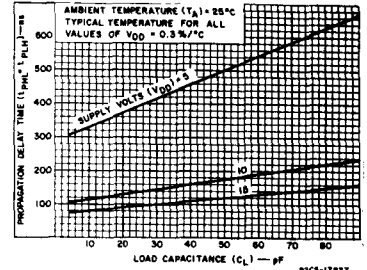

Fig. 9 — Typical propagation delay time vs.  $C_L$  for carry outputs.

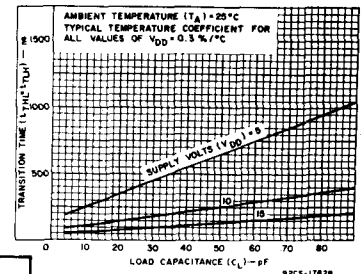

Fig. 10 — Typical transition time vs.  $C_L$  for decoded outputs.

## STATIC ELECTRICAL CHARACTERISTICS

Characteristic	Conditions			Limits at Indicated Temperatures ( $^\circ\text{C}$ )							Units		
	V <sub>O</sub> (V)	V <sub>IN</sub> (V)	V <sub>DD</sub> (V)	D, F, K, H Packages			E Package						
				-55	+25		-40	+25				+85	
Quiescent Device Current $I_L$ Max.	—	—	5	5	0.3	5	300	50	0.5	50	700	$\mu\text{A}$	
	—	—	10	10	0.5	10	600	100	1	100	1400		
	—	—	15	50	1	50	2000	500	5	500	5000		
Output Voltage: Low-Level, $V_{OL}$	—	5	5	0 Typ.; 0.05 Max.								V	
	—	10	10	0 Typ.; 0.05 Max.									
High Level, $V_{OH}$	—	0	5	4.95 Min.; 5 Typ.								V	
	—	0	10	9.95 Min.; 10 Typ.									
Noise Immunity: Inputs Low, $V_{NL}$		—	5	1.5 Min.; 2.25 Typ.								V	
		—	10	3 Min.; 4.5 Typ.									
Inputs High, $V_{NH}$		—	5	1.5 Min.; 2.25 Typ.								V	
		—	10	3 Min.; 4.5 Typ.									
Noise Margin: Inputs Low, $V_{NML}$	4.5	—	5	1 Min.								V	
	9	—	10	1 Min.									
Inputs High, $V_{NMH}$	0.5	—	5	1 Min.								V	
	1	—	10	1 Min.									
Output Drive Current $I_{DN}$ Min.	Decoded Outputs	0.5	—	5	0.15	0.24	0.12	0.09	0.08	0.24	0.06	0.05	mA
		0.5	—	10	0.32	0.5	0.25	0.18	0.15	0.5	0.12	0.1	
	Carry Output	0.5	—	5	0.12	0.4	0.15	0.1	0.095	0.4	0.08	0.06	
		0.5	—	10	0.45	1	0.35	0.25	0.3	1	0.25	0.2	
p-Channel (Source), $I_{DP}$ Min.	Decoded Outputs	4.5	—	5	-0.21	-0.28	-0.14	-0.1	-0.09	-0.28	-0.07	-0.06	mA
		9.5	—	10	-0.45	-0.6	-0.3	-0.22	-0.2	-0.6	-0.15	-0.13	
	Carry Output	4.5	—	5	-0.12	-0.4	-0.15	-0.1	-0.095	-0.4	-0.08	-0.06	
		9.5	—	10	-0.45	-1	-0.35	-0.25	-0.3	-1	-0.24	-0.2	
Input Leakage Current, $I_{IL}$ , $I_{IH}$	Any Input	—	15	$\pm 10^{-5}$ Typ., $\pm 1$ Max.								$\mu\text{A}$	

# CD4026A, CD4033A Types

DYNAMIC ELECTRICAL CHARACTERISTICS at  $T_A = 25^\circ\text{C}$ , Input  $t_r, t_f = 20\text{ ns}$ ,  $C_L = 15\text{ pF}$ ,  
 $R_L = 200\text{ k}\Omega$

CHARACTERISTIC	TEST CONDITIONS	LIMITS						UNITS
		D, F, K, H Packages			E Package			
		$V_{DD}$ (V)	Min.	Typ.	Max.	Min.	Typ.	
<b>CLOCKED OPERATION</b>								
Propagation Delay Time; $t_{PLH}, t_{PHL}$ Carry Out Line	5	—	350	1000	—	350	1300	ns
	10	—	125	250	—	125	300	
Decode Out Lines	5	—	600	1700	—	600	2200	ns
	10	—	250	500	—	250	700	
Transition Time; $t_{THL}, t_{TLH}$ Carry Out Line	5	—	100	300	—	100	350	ns
	10	—	50	150	—	50	200	
Decode Out Lines	5	—	300	900	—	300	1200	ns
	10	—	125	350	—	125	450	
Maximum Clock Input Frequency, $f_{CL}^{\Delta}$	5	1.5	2.5	—	1	2.5	—	MHz
	10	3	5	—	2	5	—	
Min. Clock Pulse Width, $t_W$	5	—	200	330	—	200	500	ns
	10	—	100	170	—	100	250	
Clock Rise & Fall Time; $t_{rCL}, t_{fCL}$	5	—	—	15	—	—	15	$\mu\text{s}$
	10	—	—	15	—	—	15	
Min. Clock Inhibit Set Up Time, $t_S$	5	—	175	500	—	175	700	ns
	10	—	75	200	—	75	300	
Average Input Capacitance, $C_i$	Any Input	—	5	—	—	5	—	pF
<b>RESET OPERATION</b>								
Propagation Delay Time: $t_{PLH}, t_{PHL}$ To Carry Out Line	5	—	350	1000	—	350	1300	ns
	10	—	125	250	—	125	300	
To Decode Out Lines	5	—	550	1400	—	550	1900	ns
	10	—	240	500	—	240	600	
Min. Reset Pulse Width $t_W$	5	—	200	330	—	200	500	ns
	10	—	100	165	—	100	250	
Min. Reset Removal Time	5	—	300	750	—	300	1000	ns
	10	—	100	225	—	100	275	

$\Delta$  Measured with respect to carry out line.

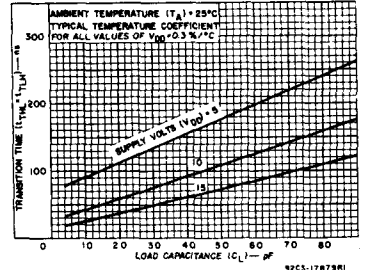

Fig. 11 — Typical transition time vs.  $C_L$  for carry output.

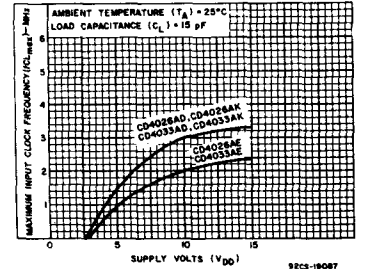

Fig. 12 — Maximum input clock frequency vs.  $V_{DD}$ .

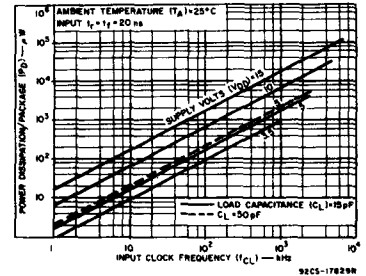

Fig. 13 — Typical dissipation characteristics.

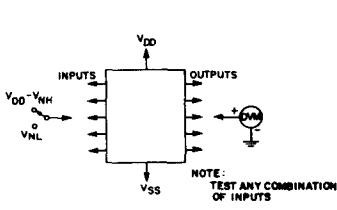

Fig. 14 — Noise immunity test circuit.

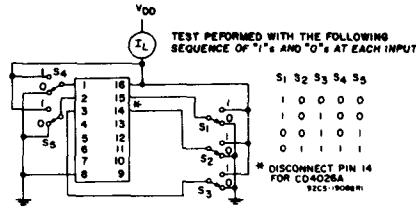

Fig. 15 — Quiescent-device-current test circuit.

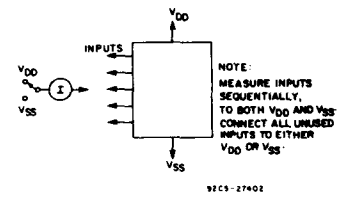

Fig. 16 — Input-leakage-current test circuit.

# CD4027A Types

## CMOS Dual J-K Master-Slave Flip-Flop

The RCA-CD4027A is a single monolithic chip integrated circuit containing two identical complementary-symmetry J-K master-slave flip-flops. Each flip-flop has provisions for individual J, K, Set, Reset, and Clock input signals. Buffered Q and  $\bar{Q}$  signals are provided as outputs. This input-output arrangement provides for compatible operation with the RCA-CD4013A dual D-type flip-flop.

The CD4027A is useful in performing control, register, and toggle functions. Logic levels present at the J and K inputs along with internal self-steering control the state of each flip-flop; changes in the flip-flop state are synchronous with the positive-going transition of the clock pulse. Set and reset functions are independent of the clock and are initiated when a high level signal is present at either the Set or Reset input.

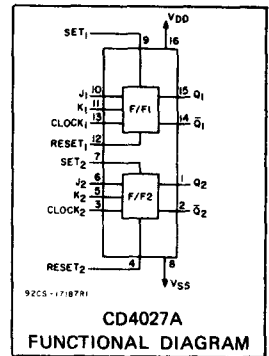

These types are supplied in 16-lead hermetic dual-in-line ceramic packages (D and F suffixes), 16-lead dual-in-line plastic package (E suffix), 16-lead ceramic flat packages (K suffix), and in chip form (H suffix).

### Features:

- Set-Reset capability
- Static flip-flop operation—retains state indefinitely with clock level either "high" or "low"
- Medium-speed operation—10 MHz (typ.) clock toggle rate at 10V
- Quiescent current specified to 15 V
- Maximum input leakage of 1  $\mu$ A at 15 V (full package-temperature range)
- 1-V noise margin (full package-temperature range)

### Applications

- Registers, counters, control circuits

### MAXIMUM RATINGS, Absolute-Maximum Values:

STORAGE-TEMPERATURE RANGE ( $T_{stg}$ )	-65 to +150°C
OPERATING-TEMPERATURE RANGE ( $T_A$ ):	
PACKAGE TYPES D, F, K, H	-55 to +125°C
PACKAGE TYPE E	-40 to +85°C
DC SUPPLY-VOLTAGE RANGE, ( $V_{DD}$ )	
(Voltages referenced to $V_{SS}$ Terminal):	-0.5 to +15 V
POWER DISSIPATION PER PACKAGE ( $P_D$ ):	
FOR $T_A = -40$ to +60°C (PACKAGE TYPE E)	500 mW
FOR $T_A = +60$ to +85°C (PACKAGE TYPE E)	Derate Linearly at 12 mW/°C to 200 mW
FOR $T_A = -55$ to +100°C (PACKAGE TYPES D, F, K)	500 mW
FOR $T_A = +100$ to +125°C (PACKAGE TYPES D, F, K)	Derate Linearly at 12 mW/°C to 200 mW
DEVICE DISSIPATION PER OUTPUT TRANSISTOR	
FOR $T_A =$ FULL PACKAGE-TEMPERATURE RANGE (ALL PACKAGE TYPES)	100 mW
INPUT VOLTAGE RANGE, ALL INPUTS	-0.5 to $V_{DD} + 0.5$ V
LEAD TEMPERATURE (DURING SOLDERING):	
At distance $1/16 \pm 1/32$ inch ( $1.59 \pm 0.79$ mm) from case for 10 s max.	+265°C

### RECOMMENDED OPERATING CONDITIONS at $T_A = 25^\circ\text{C}$ , Except as Noted.

For maximum reliability, nominal operating conditions should be selected so that operation is always within the following ranges.

CHARACTERISTIC	$V_{DD}$ (V)	LIMITS				UNITS
		D, F, K, H PACKAGES		E PACKAGE		
		MIN.	MAX.	MIN.	MAX.	
Supply-Voltage Range (For $T_A =$ Full Package-Temperature Range)		3	12	3	12	V
Data Setup Time, $t_S$	5 10	150 50	—	200 75	—	ns
Clock Pulse Width, $t_W$	5 10	330 110	—	500 165	—	ns
Clock Input Frequency (Toggle Mode) $f_{CL}$	5 10	dc	1.5 4.5	dc	1 3	MHz
Clock Rise or Fall Time, $t_{rCL}$ , * $t_{fCL}$	5 10	—	15 5	—	15 5	$\mu$ s
Set or Reset Pulse Width, $t_W$	5 10	200 80	—	300 120	—	ns

\*If more than one unit is cascaded in a parallel clocked operation,  $t_{rCL}$  should be made less than or equal to the sum of the fixed propagation delay time at 15 pF and the transition time of the output driving stage for the estimated capacitive load.

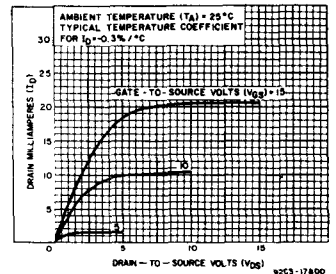

Fig. 1 — Typical n-channel drain characteristics.

# CD4027A Types

## STATIC ELECTRICAL CHARACTERISTICS

CHARACTERISTICS	CONDITIONS			LIMITS AT INDICATED TEMPERATURES (°C)								UNITS
				D, F, K, H PACKAGES				E PACKAGE				
				-55	+25		+125	-40	+25		+85	
Quiescent Device Current, $I_L$ Max.	$V_O$ (V)	$V_{IN}$ (V)	$V_{DD}$ (V)	1	TYP.	LIMIT	60	10	0.01	10	140	$\mu A$
			5	0.005	1	120	20	0.05	20	280		
			10	0.005	2	1000	250	2.5	250	2500		
Output Voltage: Low Level, $V_{OL}$	-	0.5	5	0 Typ.; 0.05 Max								V
High Level $V_{OH}$	-	0.10	10	0 Typ.; 0.05 Max								
	-	0.5	5	5 Typ.; 4.95 Min.								
Noise Immunity: Inputs Low, $V_{NL}$	-	0.10	10	10 Typ.; 9.95 Min.								V
Inputs High $V_{NH}$	4.2	-	5	2.25 Typ.; 1.5 Min.								
	9	-	10	4.5 Typ.; 3 Min.								
Noise Margin: Inputs Low, $V_{NML}$	0.8	-	5	2.25 Typ.; 1.5 Min.								V
Inputs High, $V_{NMH}$	1	-	10	4.5 Typ.; 3 Min.								
	1	-	10	1 Min.								
Output Drive Current: N Channel (Sink), $I_{DN}$ Min.	0.5	-	5	0.65	1	0.5	0.35	0.35	1	0.3	0.24	mA
P-Channel (Source): $I_{DP}$ Min.	0.5	-	10	1.25	2.5	1	0.75	0.72	2.5	0.6	0.5	
	4.5	-	5	-0.31	-0.5	-0.25	-0.175	-0.17	-0.5	-0.14	-0.12	
Input Leakage Current, $I_{IL}, I_{IH}$	9.5	-	10	-0.8	-1.3	-0.65	-0.45	-0.4	-1.3	-0.33	-0.27	$\mu A$
	Any Input		15	$\pm 10^{-5}$ Typ., $\pm 1$ Max.								

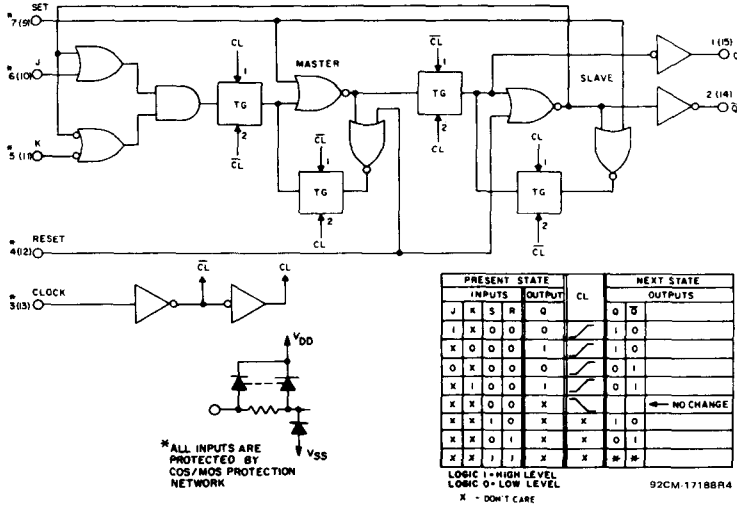

Fig. 2 - Logic diagram & truth table for CD4027A (one of two identical J-K flip flops).

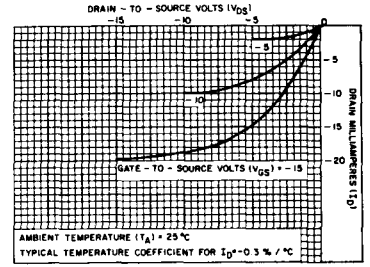

Fig. 3 - Typical p-channel drain characteristics.

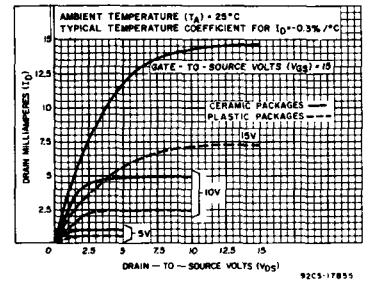

Fig. 4 - Minimum n-channel drain characteristics.

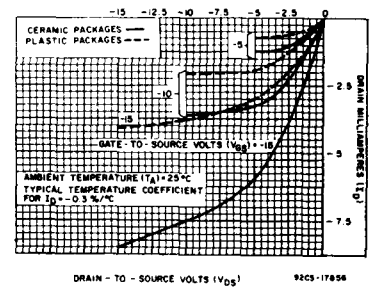

Fig. 5 - Minimum p-channel drain characteristics.

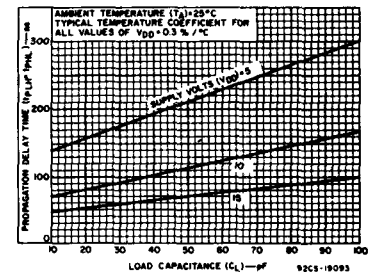

Fig. 6 - Typical propagation delay time vs.  $C_L$ .

# CD4027A Types

## DYNAMIC ELECTRICAL CHARACTERISTICS

at  $T_A = 25^\circ\text{C}$ , Input  $t_r, t_f = 20\text{ ns}$ ,  $C_L = 15\text{ pF}$ ,  $R_L = 200\text{ k}\Omega$

CHARACTERISTIC	$V_{DD}$ (V)	LIMITS						UNITS
		D, F, K, H PACKAGES			E PACKAGE			
		MIN.	TYP.	MAX.	MIN.	TYP.	MAX.	
Propagation Delay Time: Clock to Q or $\bar{Q}$ Outputs $t_{PHL}, t_{PLH}$	5 10	- -	200 100	400 200	- -	150 75	400 150	ns
Set to Q or Reset to $\bar{Q}$ , $t_{PLH}$	5 10	- -	175 75	225 110	- -	175 75	350 150	ns
Set to $\bar{Q}$ or Reset to Q, $t_{PHL}$	5 10	- -	175 75	225 110	- -	175 75	350 150	ns
Transition Time $t_{THL}, t_{TLH}$	5 10	- -	75 50	125 70	- -	75 50	250 140	ns
Maximum Clock Input Frequency (Toggle Mode) $f_{CL}$	5 10	1.5 4.5	3 8	- -	1 3	3 8	- -	MHz
Minimum Clock Pulse Width, $t_W$	5 10	- -	165 65	330 110	- -	165 65	500 165	ns
Minimum Set or Reset Pulse Width, $t_W$	5 10	- -	125 50	200 80	- -	125 50	300 120	ns
Minimum Data Setup Time, $t_S$	5 10	- -	70 25	150 50	- -	70 25	200 75	ns
Clock Rise or Fall Time, $t_{rCL}, t_{fCL}$	5 10	- -	- -	15 5	- -	- -	15 5	$\mu\text{s}$
Average Input Capacitance, $C_I$	Any Input	-	5	-	-	5	-	pF

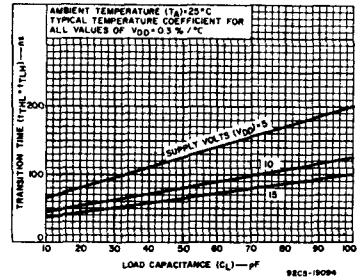

Fig. 7 - Typical transition time vs.  $C_L$ .

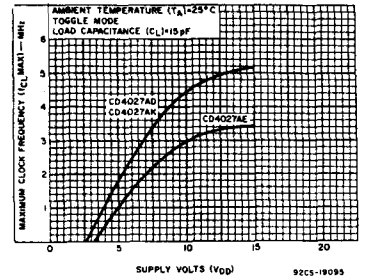

Fig. 8 - Typical maximum clock input frequency vs. supply voltage.

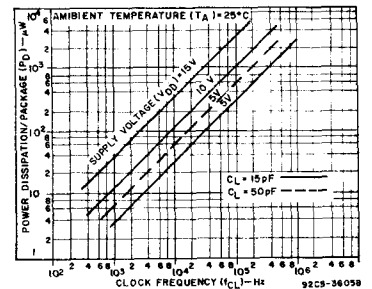

Fig. 9 - Typical dissipation characteristics.

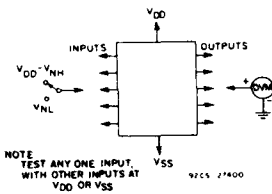

Fig. 10 - Noise immunity test circuit.

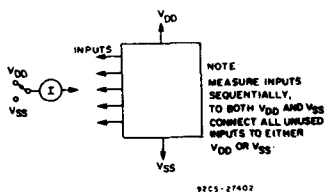

Fig. 11 - Input leakage current test circuit.

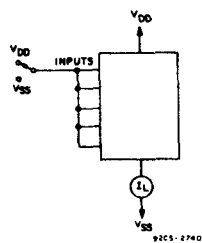

Fig. 12 - Quiescent device current test circuit.

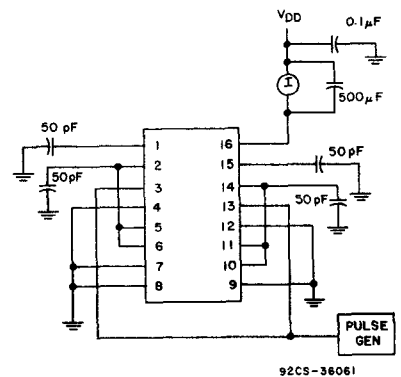

Fig. 13 - Dynamic power dissipation test circuit.



## CMOS BCD-to-Decimal Decoder

The RCA-CD4028A types are BCD-to-decimal or binary-to-octal decoders consisting of pulse-shaping circuits on all 4 inputs, decoding-logic gates, and 10 output buffers. A BCD code applied to the four inputs, A to D, results in a high level at the selected one of 10 decimal decoded outputs. Similarly, a 3-bit binary code applied to inputs A through C is decoded in octal code at output 0 to 7. A high-level signal at the D input inhibits octal decoding and causes outputs

0 through 7 to go low. If unused, the D input must be connected to  $V_{SS}$ . High drive capability is provided at all outputs to enhance dc and dynamic performance in high fan-out applications.

These types are supplied in 16-lead hermetic dual-in-line ceramic packages (D and F suffixes), 16-lead dual-in-line plastic package (E suffix), 16-lead ceramic flat package (K suffix), and in chip form (H suffix).

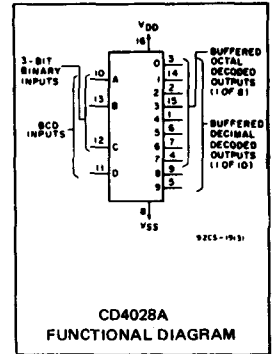

### MAXIMUM RATINGS, Absolute-Maximum Values:

STORAGE-TEMPERATURE RANGE ( $T_{stg}$ )	-65 to +150°C
OPERATING-TEMPERATURE RANGE ( $T_A$ ):	
PACKAGE TYPES D, F, K, H	-55 to +125°C
PACKAGE TYPE E	-40 to +85°C
DC SUPPLY-VOLTAGE RANGE, ( $V_{DD}$ )	
(Voltages references to $V_{SS}$ Terminal)	-0.5 to +15 V
POWER DISSIPATION PER PACKAGE ( $P_D$ ):	
FOR $T_A = -40$ to +60°C (PACKAGE TYPE E)	500 mW
FOR $T_A = +60$ to +85°C (PACKAGE TYPE E)	Derate Linearly at 12 mW/°C to 200 mW
FOR $T_A = -55$ to +100°C (PACKAGE TYPES D, F, K)	500 mW
FOR $T_A = +100$ to +125°C (PACKAGE TYPES D, F, K)	Derate Linearly at 12 mW/°C to 200 mW
DEVICE DISSIPATION PER OUTPUT TRANSISTOR	
FOR $T_A =$ FULL PACKAGE-TEMPERATURE RANGE (ALL PACKAGE TYPES)	100 mW
INPUT VOLTAGE RANGE, ALL INPUTS	-0.5 to $V_{DD}$ +0.5 V
LEAD TEMPERATURE (DURING SOLDERING):	
At distance 1/16 ± 1/32 inch (1.59 ± 0.79 mm) from case for 10 s max.	+265°C

### RECOMMENDED OPERATING CONDITIONS

For maximum reliability, nominal operating conditions should be selected so that operation is always within the following ranges:

CHARACTERISTIC	$V_{DD}$ (V)	LIMITS				UNITS
		D, F, K, H PACKAGES		E PACKAGE		
		MIN.	MAX.	MIN.	MAX.	
Supply-Voltage Range (For $T_A$ =Full Package-Temperature Range)		3	12	3	12	V

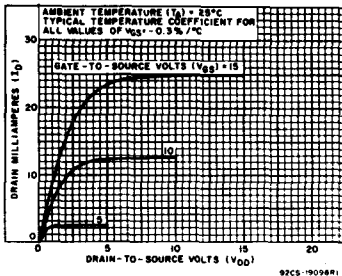

Fig. 1 - Typical output n-channel drain characteristics.

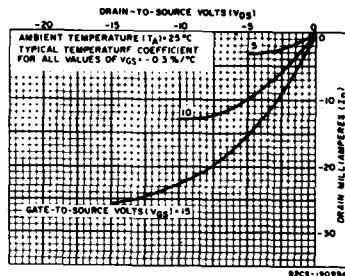

Fig. 2 - Typical output p-channel drain characteristics.

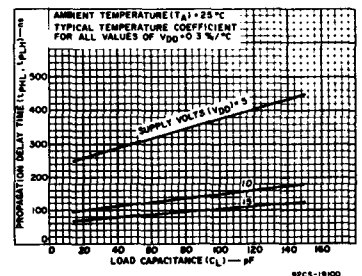

Fig. 3 - Typical propagation delay time vs.  $C_L$ .

### Features:

- BCD-to-decimal decoding or binary-to-octal decoding
- High decoded output drive capability...  
... 8 mA (typ.) sink or source
- "Positive logic" inputs and outputs...  
... decoded outputs go high on selection
- Medium-speed operation...  
...  $t_{THL}, t_{TLH} = 30$  ns (typ.) @  $V_{DD} = 10$  V
- Quiescent current specified to 15 V
- Maximum input leakage current of 1  $\mu$ A at 15 V (full package-temperature range)
- 1-V noise margin (full package-temperature range)

### Applications:

- Code conversion
- Address decoding—memory selection control
- Indicator-tube decoder

# CD4028A Types

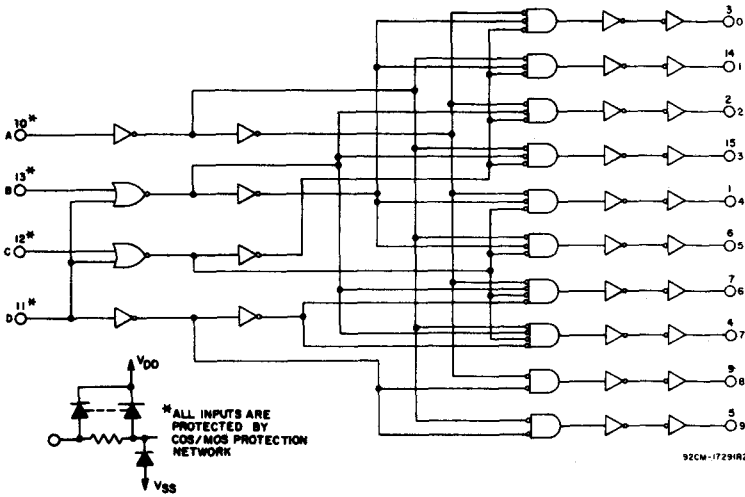

Fig. 4 - Logic diagram.

TABLE I - TRUTH TABLE

D	C	B	A	0	1	2	3	4	5	6	7	8	9
0	0	0	0	1	0	0	0	0	0	0	0	0	0
0	0	0	1	0	1	0	0	0	0	0	0	0	0
0	0	1	0	0	1	0	0	0	0	0	0	0	0
0	0	1	1	0	0	1	0	0	0	0	0	0	0
0	1	0	0	0	0	0	1	0	0	0	0	0	0
0	1	0	1	0	0	0	0	1	0	0	0	0	0
0	1	1	0	0	0	0	0	0	1	0	0	0	0
0	1	1	1	0	0	0	0	0	0	1	0	0	0
1	0	0	0	0	0	0	0	0	0	0	1	0	0
1	0	0	1	0	0	0	0	0	0	0	0	1	0
1	1	0	0	0	0	0	0	0	0	0	0	0	1
1	1	1	0	0	0	0	0	0	0	0	0	0	1
1	1	1	1	0	0	0	0	0	0	0	0	0	1

\* WHERE 1 = HIGH LEVEL  
0 = LOW LEVEL

\*\* EXTRAORDINARY STATES

## STATIC ELECTRICAL CHARACTERISTICS

CHARACTERISTIC	CONDITIONS			LIMITS AT INDICATED TEMPERATURES (°C)								UNITS
				D, F, K, H PACKAGES				E PACKAGE				
				-55	+25		-40	+25		+85		
Quiescent Device Current, $I_{L}$ Max.	$V_D$ (V)	$V_{IN}$ (V)	$V_{DD}$ (V)	5	0.5	5	300	50	5	50	700	$\mu A$
	-	-	10	10	1	10	600	100	10	100	1400	
	-	-	15	50	1	50	2000	500	10	500	5000	
Output Voltage: Low-Level, $V_{OL}$	-	5	5	0 Typ.; 0.05 Max.								V
	-	10	10	0 Typ.; 0.05 Max.								
High Level $V_{OH}$	-	0	5	4.95 Min.; 5 Typ.								V
	-	0	10	9.95 Min.; 10 Typ.								
Noise Immunity: Inputs Low, $V_{NL}$	4.2	-	5	1.5 Min.; 2.25 Typ.								V
	9	-	10	3 Min.; 4.5 Typ.								
Inputs High $V_{NH}$	0.8	-	5	1.5 Min.; 2.25 Typ.								V
	1	-	10	3 Min.; 4.5 Typ.								
Noise Margin: Inputs Low, $V_{NML}$	4.5	-	5	1 Min.								V
	9	-	10	1 Min.								
	Inputs High, $V_{NMH}$	0.5	-	5	1 Min.							
Output Drive Current N-Channel (Sink), $I_{DN}$ Min.	0.5	-	5	0.75	1.2	0.6	0.45	0.35	1.2	0.3	0.25	mA
	0.5	-	10	1.5	2.4	1.2	0.9	0.7	2.4	0.6	0.5	
P-Channel (Source), $I_{DP}$ Min.	4.5	-	5	-0.7	-0.9	-0.45	-0.32	-0.32	-0.9	-0.22	-0.18	mA
	9	-	10	-1.4	-1.9	-0.95	-0.65	-0.65	-1.9	-0.48	-0.4	
Input Leakage Current, $I_{IL}, I_{IH}$	Any Input	-	15	$\pm 10^{-5}$ Typ., $\pm 1$ Max.								$\mu A$

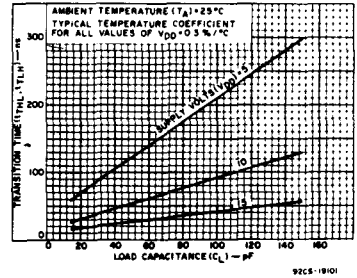

Fig. 5 - Typical transition time vs.  $C_L$ .

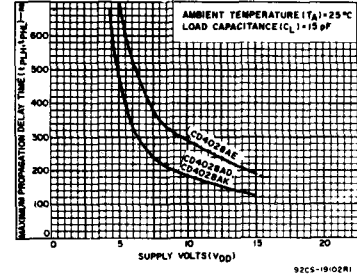

Fig. 6 - Maximum propagation delay time vs.  $V_{DD}$ .

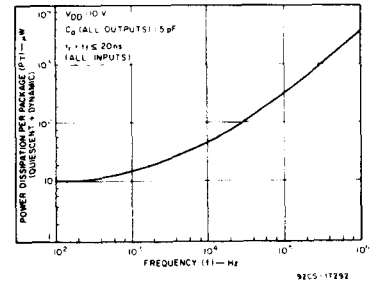

Fig. 7 - Dissipation vs. input frequency.

# CD4028A Types

## DYNAMIC ELECTRICAL CHARACTERISTICS

at  $T_A = 25^\circ\text{C}$ , Input  $t_r, t_f = 20\text{ ns}$ ,  $C_L = 15\text{ pF}$ ,  $R_L = 200\text{ k}\Omega$

CHARACTERISTIC	TEST CONDITIONS	LIMITS						UNITS	
		D, F, K, H PACKAGES			E PACKAGE				
		VDD (V)	MIN.	TYP.	MAX.	MIN.	TYP.		MAX.
Propagation Delay Time; $t_{PLH}, t_{PHL}$		5	-	250	480	-	250	700	ns
		10	-	100	180	-	100	290	
Transition Time; $t_{THL}, t_{TLH}$		5	-	60	150	-	60	300	ns
		10	-	30	75	-	30	150	
Average Input Capacitance, $C_i$	Any Input	-	5	-	-	5	-	pF	

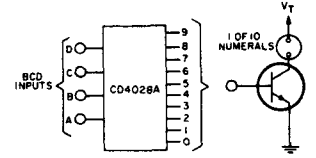

▲ (Trademark) Burroughs Corp. 92CS-17295R1

### TUBE REQUIREMENTS

Type	$V_T$ (Vdc)	mA/numeral
Burroughs 84081	170	1.4
84336/718	170	2
84032	170	1.4
84021	170	1.4

### TRANSISTOR CHARACTERISTICS

Leakage with transistor cutoff  $\leq 0.05\text{ mA}$   
 $V_{IBR}/C_{EO} = 2.70\text{V}$

Fig. 9 - Neon readout (Nixie Tube®) display application.

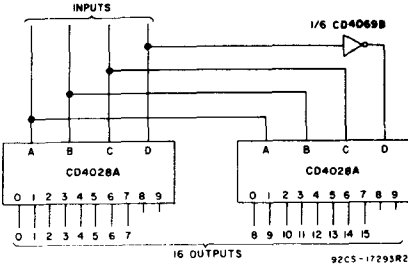

Fig. 8 - Code conversion circuit.

The circuit shown in Fig. 9 converts any 4-bit code to a decimal or hexadecimal code. Table 2 shows a number of codes and the decimal or hexadecimal number in these codes which must be applied to the input terminals of the CD4028A to select a particular output. For example: in order to get a high on output No. 8 the input must be either an 8 expressed in 4-Bit Binary code, a 15 expressed in 4-Bit Gray code, or a 5 expressed in Excess-3 code.

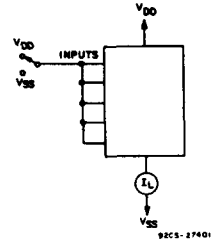

Fig. 10 - Quiescent device current test circuit.

TABLE II - CODE CONVERSION CHART

INPUTS				INPUT CODES					OUTPUT NUMBER																	
				Hexa-Decimal		Decimal																				
D	C	B	A	4-BIT BINARY	4-BIT GRAY	EXCESS-3	EXCESS-3 GRAY	AIKEN	4-2-1	0	1	2	3	4	5	6	7	8	9	10	11	12	13	14	15	
0	0	0	0	0	0					0	0	1	0	0	0	0	0	0	0	0	0	0	0	0	0	0
0	0	0	1	1	1					1	1	0	1	0	0	0	0	0	0	0	0	0	0	0	0	0
0	0	1	0	2	3	0	2	2		0	0	1	0	0	0	0	0	0	0	0	0	0	0	0	0	0
0	0	1	1	3	2	0	3	3		0	0	0	1	0	0	0	0	0	0	0	0	0	0	0	0	0
0	1	0	0	4	7	1	4	4		0	0	0	0	1	0	0	0	0	0	0	0	0	0	0	0	0
0	1	0	1	5	6	2			3	0	0	0	0	0	1	0	0	0	0	0	0	0	0	0	0	0
0	1	1	0	6	4	3	1		4	0	0	0	0	0	0	1	0	0	0	0	0	0	0	0	0	0
0	1	1	1	7	5	4	2			0	0	0	0	0	0	0	1	0	0	0	0	0	0	0	0	0
1	0	0	0	8	15	5				0	0	0	0	0	0	0	0	1	0	0	0	0	0	0	0	0
1	0	0	1	9	14	6			5	0	0	0	0	0	0	0	0	0	1	0	0	0	0	0	0	0
1	0	1	0	10	12	7	9		6	0	0	0	0	0	0	0	0	0	0	1	0	0	0	0	0	0
1	0	1	1	11	13	8			5	0	0	0	0	0	0	0	0	0	0	0	1	0	0	0	0	0
1	1	0	0	12	8	9	5	6		0	0	0	0	0	0	0	0	0	0	0	0	0	0	1	0	0
1	1	0	1	13	9	6	7		7	0	0	0	0	0	0	0	0	0	0	0	0	0	0	0	1	0
1	1	1	0	14	11	8	8	8		0	0	0	0	0	0	0	0	0	0	0	0	0	0	0	0	1
1	1	1	1	15	10	7	9	9		0	0	0	0	0	0	0	0	0	0	0	0	0	0	0	0	1

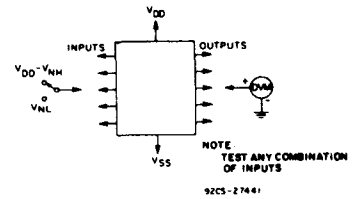

Fig. 11 - Noise-immunity test circuit.

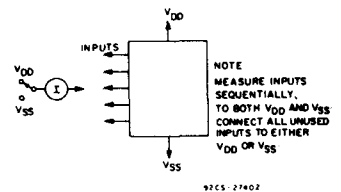

Fig. 12 - Input-leakage-current test circuit.

# CD4029A Types

## CMOS Presettable Up/Down Counter

Binary or BCD-Decade

The RCA-CD4029A consists of a four-stage binary or BCD-decade up/down counter with provisions for look-ahead carry in both counting modes. The inputs consist of a single CLOCK, CARRY-IN (CLOCK INHIBIT), BINARY/DECADE, UP/DOWN, PRESET ENABLE, and four individual JAM signals and a CARRY OUT signal are provided as outputs.

A high PRESET ENABLE signal allows information on the JAM INPUTS to preset the counter to any state asynchronously with the clock. A low on each JAM line, when the PRESET-ENABLE signal is high, resets the counter to its zero count. The counter is advanced one count at the positive transition of the clock when the CARRY-IN and PRESET ENABLE signals are low. Advancement is inhibited when the CARRY-IN or PRESET ENABLE signals are high. The CARRY-OUT signal is normally high and goes low when the counter reaches its maximum count in the UP mode or the minimum count in the DOWN mode provided the CARRY-IN signal is low. The CARRY-IN signal in the high state can thus be considered a CLOCK INHIBIT. The CARRY-IN terminal must be connected to  $V_{SS}$  when not in use.

Binary counting is accomplished when the BINARY/DECADE input is high; the counter counts in the decade mode when the BINARY/DECADE input is low. The counter counts Up when the UP/DOWN INPUT is high, and Down when the UP/DOWN INPUT

### Features:

- Medium speed operation . . . 5 MHz (typ.) @  $C_L=15$  pF and  $V_{DD}-V_{SS}=10$  V
- Multi-package parallel clocking for synchronous high speed output response or ripple clocking for slow clock input rise and fall times
- "Preset Enable" and individual "Jam" inputs provided
- Binary or decade up/down counting
- BCD outputs in decade mode
- Quiescent current specified to 15 V
- Maximum input leakage current of 1  $\mu$ A at 15 V (full package-temperature range)
- 1-V noise margin (full package-temperature range)

### Applications:

- Programmable binary and decade counting/frequency synthesizers-BCD output
- Analog to digital and digital to analog conversion
- Up/Down binary counting
- Magnitude and sign generation
- Up/Down decade counting
- Difference counting

is low. Multiple packages can be connected in either a parallel-clocking or a ripple-clocking arrangement.

Parallel clocking provides synchronous control and hence faster response from all counting outputs. Ripple-clocking allows for longer clock input rise and fall times.

These types are supplied in 16-lead hermetic dual-in-line ceramic packages (D and F suffixes), 16-lead dual-in-line plastic package (E suffix), 16-lead ceramic flat packages (K suffix), and in chip form (H suffix).

**RECOMMENDED OPERATING CONDITIONS** at  $T_A=25^\circ\text{C}$ , Except as Noted. For maximum reliability, nominal operating conditions should be selected so that operation is always within the following ranges:

CHARACTERISTIC	$V_{DD}$ (V)	LIMITS				UNITS
		D, F, K, H Packages		E Package		
		Min.	Max.	Min.	Max.	
Supply-Voltage Range (For $T_A$ =Full Package-Temperature Range)		3	12	3	12	V
Setup Time, $t_S^*$	5 10	650 230	— —	1300 460	— —	ns
Clock Pulse Width, $t_W$	5 10	340 170	— —	500 250	— —	ns
Clock Input Frequency, $f_{CL}$	5 10	dc dc	1.5 3	dc dc	1 2	MHz
Clock Rise or Fall Time, $t_{rCL}, t_{fCL}^{**}$	5 10	— —	15 15	— —	15 15	$\mu$ s
Preset Enable Pulse Width, $t_W$	5 10	330 160	— —	660 320	— —	ns

\*From Up/Down, Binary/Decode, Carry In, or Preset Enable Control Inputs to Clock Edge

\*\*If more than one unit is cascaded in the parallel clocked application,  $t_{rCL}$  should be made less than or equal to the sum of the fixed propagation delay at 15 pF and the transition time of the carry output driving stage for the estimated capacitive load.

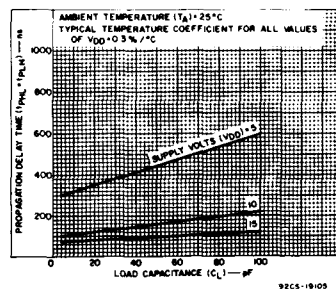
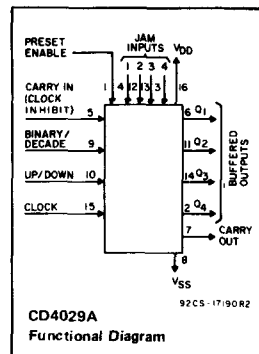

Fig. 1—Typical propagation delay time vs.  $C_L$  for Q outputs.

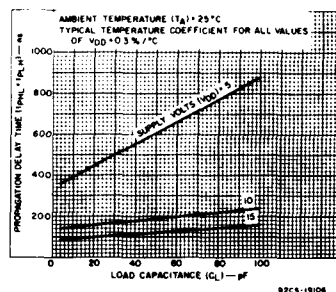

Fig. 2—Typical propagation delay time vs.  $C_L$  for carry output.

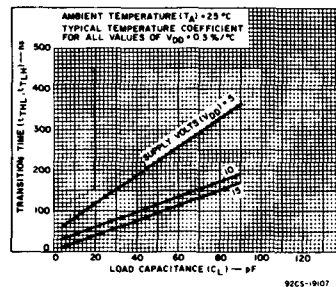

Fig. 3—Typical transition time vs.  $C_L$  for Q outputs.

# CD4029A Types

## MAXIMUM RATINGS, Absolute-Maximum Values:

STORAGE-TEMPERATURE RANGE ( $T_{stg}$ )	-65 to +150°C
OPERATING-TEMPERATURE RANGE ( $T_A$ ):	
PACKAGE TYPES D, F, K, H	-55 to +125°C
PACKAGE TYPE E	-40 to +85°C
DC SUPPLY-VOLTAGE RANGE, ( $V_{DD}$ )	
(Voltages referenced to $V_{SS}$ Terminal)	0.5 to +15 V
POWER DISSIPATION PER PACKAGE ( $P_D$ ):	
FOR $T_A = -40$ to +60°C (PACKAGE TYPE E)	500 mW
FOR $T_A = +60$ to +85°C (PACKAGE TYPE E)	Derate Linearly at 12 mW/°C to 200 mW
FOR $T_A = -55$ to +100°C (PACKAGE TYPES D, F, K)	500 mW
FOR $T_A = +100$ to +125°C (PACKAGE TYPES D, F, K)	Derate Linearly at 12 mW/°C to 200 mW
DEVICE DISSIPATION PER OUTPUT TRANSISTOR:	
FOR $T_A = \text{FULL PACKAGE-TEMPERATURE RANGE (ALL PACKAGE TYPES)}$	100 mW
INPUT VOLTAGE RANGE, ALL INPUTS	0.5 to $V_{DD}$ 10.5 V
LEAD TEMPERATURE (DURING SOLDERING):	
At distance 1/16 ± 1/32 inch (1.59 ± 0.79 mm) from case for 10 s max.	+265°C

## DYNAMIC ELECTRICAL CHARACTERISTICS at $T_A = 25^\circ\text{C}$ , Input $t_r, t_f = 20$ ns, $C_L = 15$ pF, $R_L = 200$ k $\Omega$

CHARACTERISTIC	TEST CONDITIONS	LIMITS						UNITS
		D, F, K, H Packages			E Package			
		Min.	Typ.	Max.	Min.	Typ.	Max.	
<b>Clocked Operation</b>								
Propagation Delay Time:								
$t_{PHL}$ , $t_{PLH}$	5	--	325	650	--	325	1300	ns
Q Outputs	10	--	115	230	--	115	460	
Carry Output	5	--	425	850	--	425	1700	ns
	10	--	150	300	--	150	600	
Transition Time:								
$t_{THL}$ , $t_{TLH}$	5	--	100	200	--	100	400	ns
Q Outputs	10	--	50	100	--	50	200	
Carry Output	5	--	200	400	--	200	800	ns
	10	--	100	200	--	100	400	
Minimum Clock Pulse Width, $t_{Wp}$	5	--	200	340	--	200	500	ns
	10	--	100	170	--	100	250	
Clock Rise & Fall Time, $t_{rCL}$ , $t_{fCL}^{**}$	5	--	--	15	--	--	15	$\mu\text{s}$
	10	--	--	15	--	--	15	
Minimum Setup Times, $t_S^*$	5	--	325	650	--	325	1300	ns
	10	--	115	230	--	115	460	
Maximum Clock Input Frequency, $f_{CL}$	5	1.5	2.5	--	1	2.5	--	MHz
	10	3	5	--	2	5	--	
Input Capacitance, $C_i$	Any Input	--	5	--	--	5	--	pF
<b>Preset Enable</b>								
Propagation Delay Time:								
$t_{PHL}$ , $t_{PLH}$	5	--	325	650	--	325	1300	ns
Q Outputs	10	--	115	230	--	115	460	
Carry Output	5	--	425	850	--	425	1700	ns
	10	--	150	300	--	150	600	
Minimum Preset Enable Pulse Width, $t_{Wp}$	5	--	115	330	--	115	660	ns
	10	--	80	160	--	80	320	
Minimum Preset Enable Removal Time	5	--	325	650	--	325	1300	ns
	10	--	115	230	--	115	460	
<b>Carry Input</b>								
Propagation Delay Time:								
$t_{PHL}$ , $t_{PLH}$	5	--	175	350	--	175	700	ns
Carry Output	10	--	50	100	--	50	200	

For footnotes, see Recommended Operating Conditions.

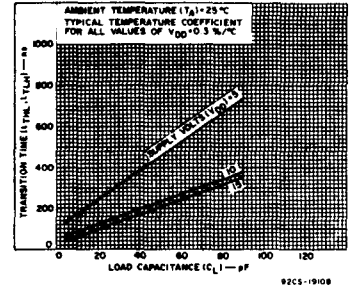

Fig. 4—Typical transition time vs.  $C_L$  for carry output.

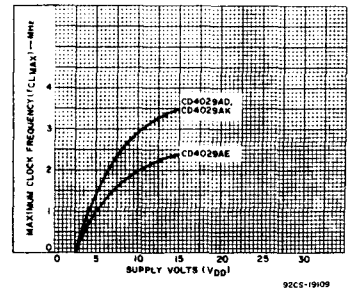

Fig. 5—Maximum clock input frequency vs.  $V_{DD}$ .

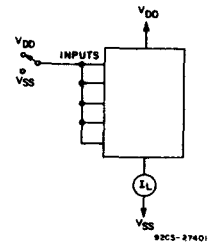

Fig. 6—Quiescent device current test circuit.

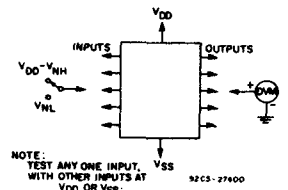

Fig. 7—Noise immunity test circuit.

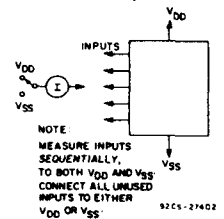

Fig. 8—Input leakage current test circuit.

# CD4029A Types

## STATIC ELECTRICAL CHARACTERISTICS

Characteristic	Conditions			Limits at Indicated Temperatures (°C)								Units
	V <sub>O</sub> (V)	V <sub>IN</sub> (V)	V <sub>DD</sub> (V)	D, F, K, H Packages				E Package				
				-55	+25		+125	-40	+25		+85	
Quiescent Device Current, I <sub>L</sub> Max.	-	-	5	5	0.3	5	300	50	0.5	50	700	μA
	-	-	10	10	0.5	10	600	100	1	100	1400	
	-	-	15	50	1	50	2000	500	5	500	5000	
Output Voltage: Low-Level, V <sub>OL</sub>	-	5	5	0 Typ.; 0.05 Max.								V
	-	10	10	0 Typ.; 0.05 Max.								
Output Voltage: High-Level, V <sub>OH</sub>	-	0	5	4.95 Min.; 5 Typ.								V
	-	0	10	9.95 Min.; 10 Typ.								
Noise Immunity: Inputs Low, V <sub>NL</sub>	4.2	-	5	1.5 Min.; 2.25 Typ.								V
	9	-	10	3 Min.; 4.5 Typ.								
Noise Immunity: Inputs High, V <sub>NH</sub>	0.8	-	5	1.5 Min.; 2.25 Typ.								V
	1	-	10	3 Min.; 4.5 Typ.								
Noise Margin: Inputs Low, V <sub>NML</sub>	4.5	-	5	1 Min.								V
	9	-	10	1 Min.								
Noise Margin: Inputs High, V <sub>NMH</sub>	0.5	-	5	1 Min.								V
	1	-	10	1 Min.								
Output Drive Current: N-Channel (Sink), I <sub>DN</sub> Min.	0.5	-	5	0.5	0.8	0.4	0.28	0.24	0.8	0.2	0.16	mA
	Q Outputs	0.5	-	10	0.74	1.2	0.6	0.42	0.36	1.2	0.3	
Output Drive Current: P-Channel (Source), I <sub>DP</sub> Min.	0.5	-	5	0.1	0.16	0.08	0.06	0.05	0.16	0.04	0.03	mA
	Q Outputs	0.5	-	10	0.4	0.64	0.32	0.22	0.19	0.64	0.16	
Output Drive Current: Carry Output	4.5	-	5	-0.18	-0.24	-0.12	-0.08	-0.07	-0.24	-0.06	-0.05	mA
	Q Outputs	4.5	-	10	-0.3	-0.4	-0.2	-0.14	-0.14	-0.4	-0.1	
Output Drive Current: Carry Output	4.5	-	5	-0.09	-0.12	-0.06	-0.04	-0.04	-0.12	-0.03	-0.02	mA
	Q Outputs	4.5	-	10	-0.15	-0.2	-0.1	-0.07	-0.07	-0.2	-0.05	
Input Leakage Current, I <sub>IL</sub> , I <sub>IH</sub>	Any Input			±10 <sup>-5</sup> Typ., ±1 Max.								μA

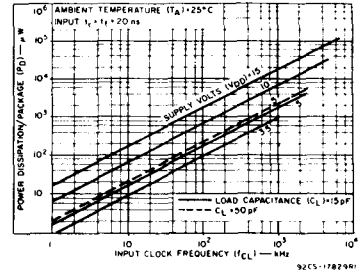

Fig. 9—Typical dissipation characteristics.

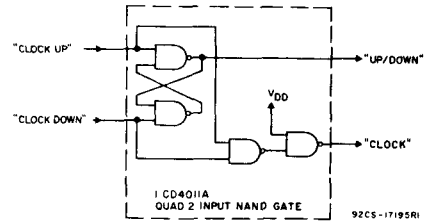

Fig. 10—Conversion of clock up, clock down input signals to clock and up/down input signals.

The CD4029A CLOCK and UP/DOWN inputs are used directly in most applications. In applications where CLOCK UP and CLOCK DOWN inputs are provided, conversion to the CD4029A CLOCK and UP/DOWN inputs can easily be realized by use of the circuit shown below.

CD4029A changes count on positive transitions of CLOCK UP or CLOCK DOWN inputs. For the gate configuration shown below, when counting down the CLOCK DOWN input must be maintained high and conversely when counting down the CLOCK UP input must be maintained high.

CLOCK	TE	PE	J	Q	Q
X	X	0	0	0	0
L	1	1	X	0	0
X	X	0	1	1	0
L	0	1	X	0	0
L	X	1	X	0	NC
L	X	1	X	0	NC

NC—NO CHANGE TE—TOGGLE ENABLE

CLOCK	TE	PE	J	Q	Q
X	X	0	0	0	0
L	0	1	X	0	0
X	X	0	1	1	0
L	1	1	X	0	0
L	X	1	X	0	NC
L	X	1	X	0	NC

X—DON'T CARE

CONTROL INPUT	LOGIC LEVEL	ACTION
BIN/DEC (B/D)	1	BINARY COUNT
BIN/DEC (B/D)	0	DECADE COUNT
UP/DOWN (U/D)	1	UP COUNT
UP/DOWN (U/D)	0	DOWN COUNT
PRESET ENABLE (PE)	1	JAM IN
PRESET ENABLE (PE)	0	NO JAM
CARRY IN (CI) (CLOCK INHIBIT)	1	NO COUNTER
CARRY IN (CI) (CLOCK INHIBIT)	0	ADVANCE AT POS. CLOCK TRANSITION
CARRY IN (CI) (CLOCK INHIBIT)	0	ADVANCE COUNTER AT POS. CLOCK TRANSITION

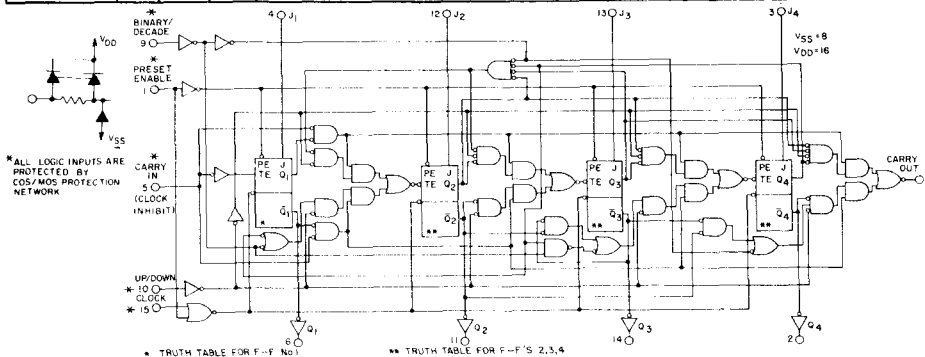
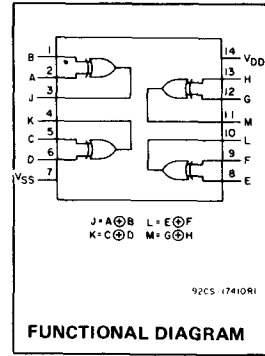

Fig. 11—Logic diagram.

# CMOS Quad Exclusive-OR Gate

The RCA-CD4030A types consist of four independent Exclusive-OR gates integrated on a single monolithic silicon chip. Each Exclusive-OR gate consists of four n-channel and four p-channel enhancement-type transistors. All inputs and outputs are protected against electrostatic effects.

These types are supplied in 14-lead hermetic dual-in-line ceramic packages (D and F suffixes), 14-lead dual-in-line plastic package (E suffix), 14-lead ceramic flat package (K suffix), and in chip form (H suffix).



FUNCTIONAL DIAGRAM

### MAXIMUM RATINGS, Absolute-Maximum Values

STORAGE TEMPERATURE RANGE ( $T_{stg}$ )	-65 to +150°C
OPERATING TEMPERATURE RANGE ( $T_A$ )	
PACKAGE TYPES D, F, K, H	-55 to +125°C
PACKAGE TYPE E	-40 to +85°C
DC SUPPLY VOLTAGE RANGE ( $V_{DD}$ )	
(Voltages referenced to $V_{SS}$ Terminal)	-0.5 to +15V
POWER DISSIPATION PER PACKAGE ( $P_D$ )	
FOR $T_A = -40$ to +60°C (PACKAGE TYPE E)	500 mW
FOR $T_A = +60$ to +85°C (PACKAGE TYPE E)	Derate Linearly at 12 mW/°C to 200 mW
FOR $T_A = -55$ to +100°C (PACKAGE TYPES D, F, K)	500 mW
FOR $T_A = +100$ to +125°C (PACKAGE TYPES D, F, K)	Derate Linearly at 12 mW/°C to 200 mW
DEVICE DISSIPATION PER OUTPUT TRANSISTOR	
FOR $T_A =$ FULL PACKAGE TEMPERATURE RANGE (ALL PACKAGE TYPES)	100 mW
INPUT VOLTAGE RANGE, ALL INPUTS	-0.5 to $V_{DD} + 0.5$
LEAD TEMPERATURE (DURING SOLDERING)	
At distance 1/16 ± 1/32 inch (159 ± 0.79 mm) from case for 10s max.	+265°C

### Features:

- Medium speed operation. . . . .  $t_{PHL} = t_{PLH} = 40$  ns (typ.) @  $C_L = 15$  pF and  $V_{DD} - V_{SS} = 10$  V
- Low output impedance. . . . . 500  $\Omega$  (typ.) @  $V_{DD} - V_{SS} = 10$  V
- Quiescent current specified to 15 V
- Maximum input leakage current of 1  $\mu$ A at 15 V (Full package-temperature range)
- 1-V noise margin (full package-temperature range)

### Applications:

- Even and odd-parity generators and checkers
- Logical comparators
- Adders/subtractors
- General logic functions

### RECOMMENDED OPERATING CONDITIONS at $T_A = 25^\circ\text{C}$ ,

For maximum reliability, nominal operating conditions should be selected so that operation is always within the following ranges:

CHARACTERISTIC	LIMITS				UNITS
	D, F, K, H Packages		E Package		
	Min.	Max.	Min.	Max.	
Supply Voltage Range (For $T_A =$ Full Package Temperature Range)	3	12	3	12	V

\* ALL INPUTS ARE PROTECTED BY COS/MOS PROTECTION NETWORK

### TRUTH TABLE FOR ONE OF FOUR IDENTICAL GATES

A	B	J
0	0	0
1	0	1
0	1	1
1	1	0

WHERE "1" = HIGH LEVEL  
"0" = LOW LEVEL

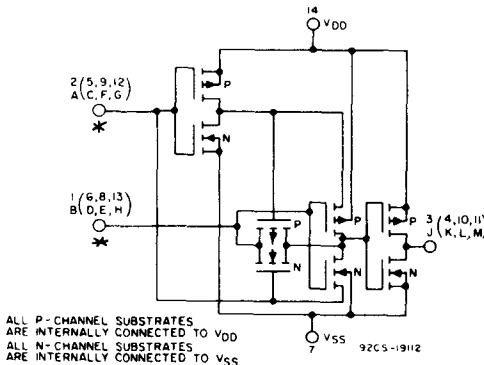

Fig. 1 - Schematic diagram for 1 of 4 identical exclusive-OR gates.

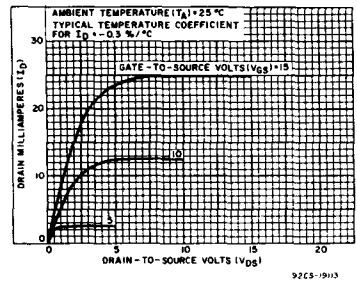

Fig. 2 - Typical output n-channel drain characteristics.

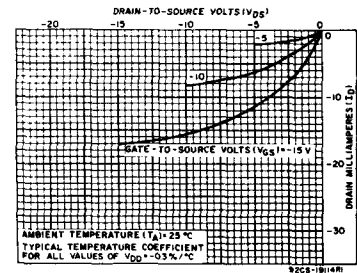

Fig. 3 - Typical output p-channel drain characteristics.

For quiescent device current, noise immunity, and input leakage current test circuits see "Rating and Characteristics" at the beginning of the CMOS section.

# CD4030A Types

## STATIC ELECTRICAL CHARACTERISTICS

Characteristic	Conditions			Limits at Indicated Temperatures (°C)									Units
				D, F, K, H Packages						E Package			
	V <sub>O</sub> (V)	V <sub>IN</sub> (V)	V <sub>DD</sub> (V)	-55	+25		+125	-40	+25		+85		
Quiescent Device Current I <sub>L</sub> Max.	-	-	5	0.5	0.005	0.5	30	5	0.05	5	70	μA	
	-	-	10	1	0.01	1	60	10	0.1	10	140		
	-	-	15	25	0.5	25	1000	250	2.5	250	2500		
Output Voltage: Low Level, V <sub>OL</sub>	-	5	5	0 Typ.; 0.05 Max.									V
	-	10	10	0 Typ.; 0.05 Max.									
High Level V <sub>OH</sub>	-	0	5	4.95 Min.; 5 Typ.									V
	-	0	10	9.95 Min.; 10 Typ.									
Noise Immunity: Inputs Low, V <sub>NL</sub>	3.6	-	5	1.5 Min.; 2.25 Typ.									V
	7.2	-	10	3 Min.; 4.5 Typ.									
Inputs High V <sub>NH</sub>	1.4	-	5	1.5 Min.; 2.25 Typ.									V
	2.8	-	10	3 Min.; 4.5 Typ.									
Noise Margin: Inputs Low, V <sub>NML</sub>	4.5	-	5	1 Min.									V
	9	-	10	1 Min.									
	0.5	-	5	1 Min.									
Inputs High, V <sub>NMH</sub>	1	-	10	1 Min.									V
Output Drive Current: N Channel (Sink) I <sub>DN</sub> Min.	0.5	-	5	0.75	1.2	0.6	0.45	0.35	1.2	0.3	0.25	mA	
	0.5	-	10	1.5	2.4	1.2	0.9	0.7	2.4	0.6	0.5		
P Channel (Source): I <sub>DP</sub> Min.	4.5	-	5	-0.45	-0.6	-0.3	-0.21	-0.21	-0.6	-0.15	-0.12	mA	
	9.5	-	10	-0.95	-1.3	-0.65	-0.45	-0.45	-1.3	-0.32	-0.25		
Input Leakage Current I <sub>IL</sub> , I <sub>IH</sub>	Any Input			± 10 <sup>-5</sup> Typ., ± 1 Max.									μA
	-	-	15										

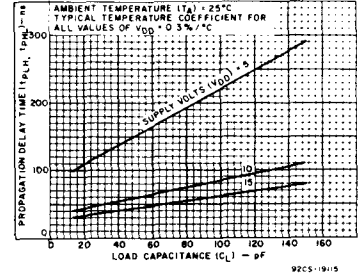

Fig. 4 - Typical propagation-delay time vs. load capacitance.

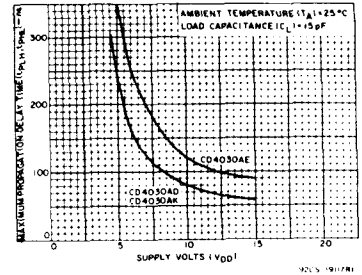

Fig. 5 - Maximum propagation-delay time vs. supply voltage.

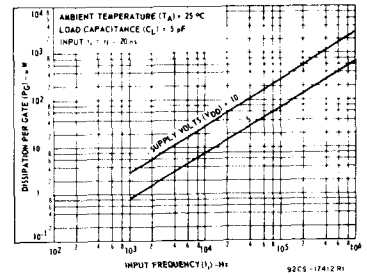

Fig. 6 - Typical dynamic power dissipation characteristics.

DYNAMIC ELECTRICAL CHARACTERISTICS at T<sub>A</sub> = 25°C, Input t<sub>r</sub>, t<sub>f</sub> = 20 ns, C<sub>L</sub> = 15 pF, R<sub>L</sub> = 200 kΩ

Characteristic	Test Conditions	LIMITS						Units	
		V <sub>DD</sub> (V)	D, F, K, H Packages			E Package			
			Min.	Typ.	Max.	Min.	Typ.		Max.
Propagation Delay Time: t <sub>PLH</sub> , t <sub>PHL</sub>		5	-	100	200	-	100	300	ns
		10	-	40	100	-	40	150	
Transition Time: High-to-Low Level, t <sub>T</sub> HL		5	-	70	150	-	70	300	ns
		10	-	25	75	-	25	150	
	Low-to-High Level, t <sub>T</sub> LH	5	-	80	150	-	80	300	
		10	-	30	75	-	30	150	
Average Input Capacitance, C <sub>i</sub>	Any Input	-	5	-	-	5	-	pF	

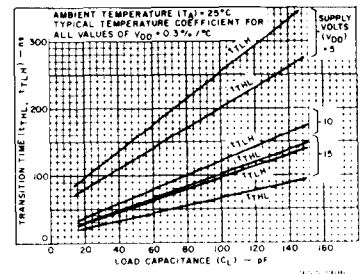

Fig. 7 - Typical transition time vs. load capacitance.



# CMOS 64-Stage Static Shift Register

The RCA-CD4031A is a 64-stage static shift register in which each stage is a D-type, master-slave flip-flop.

The logic level present at the DATA input is transferred into the first stage and shifted one stage at each positive-going clock transition. Maximum clock frequencies up to 4 Megahertz (typical) can be obtained. Because fully static operation is allowed, information can be permanently stored with the clock line in either the low or high state. The CD4031A has a MODE CONTROL input that, when in the high state, allows operation in the recirculating mode. Register packages can be cascaded and the clock lines driven directly for high speed operation. Alternatively, a delayed clock output (CL<sub>D</sub>) is provided that enables cascading register packages while allowing reduced clock drive fan-out and rise- and fall-time requirements.

Data (Q) and  $\overline{\text{Data}}$  ( $\overline{\text{Q}}$ ) outputs are provided from the 64th register stage. The Data (Q) output is capable of driving one TTL or DTL load.

These types are supplied in 16-lead hermetic dual-in-line ceramic packages (D and F suffixes), 16-lead dual-in-line plastic package (E suffix), 16-lead ceramic flat packages (K suffix), and in chip form (H suffix).

**Features:**

- Fully static operation: DC to 4 MHz typ. @ V<sub>DD</sub> - V<sub>SS</sub> = 10 V
- Operation from a single 3 to 15 V positive or negative power supply
- High noise immunity
- Microwatt quiescent power dissipation: 10 μW (typ.) for ceramic packages; 100 μW (typ.) for plastic packages

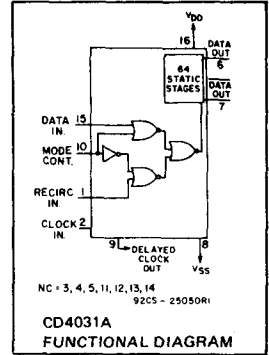

**MAXIMUM RATINGS, Absolute-Maximum Values:**

STORAGE-TEMPERATURE RANGE (T <sub>stg</sub> )	-65 to +150°C
OPERATING-TEMPERATURE RANGE (T <sub>A</sub> ):	
PACKAGE TYPES D, F, K, H	-55 to +125°C
PACKAGE TYPE E	-40 to +85°C
DC SUPPLY-VOLTAGE RANGE, (V <sub>DD</sub> )	
Voltages referenced to V <sub>SS</sub> Terminal:	-0.5 to +15 V
POWER DISSIPATION PER PACKAGE (P <sub>D</sub> )	
FOR T <sub>A</sub> = -40 to +60°C (PACKAGE TYPE E)	500 mW
FOR T <sub>A</sub> = +60 to +85°C (PACKAGE TYPE E)	Derate Linearly at 12 mW/°C to 200 mW
FOR T <sub>A</sub> = -55 to +100°C (PACKAGE TYPES D, F, K)	500 mW
FOR T <sub>A</sub> = +100 to +125°C (PACKAGE TYPES D, F, K)	Derate Linearly at 12 mW/°C to 200 mW
DEVICE DISSIPATION PER OUTPUT TRANSISTOR	
FOR T <sub>A</sub> = FULL PACKAGE-TEMPERATURE RANGE (ALL PACKAGE TYPES)	100 mW
INPUT VOLTAGE RANGE, ALL INPUTS	-0.5 to V <sub>DD</sub> + 0.5 V
LEAD TEMPERATURE (DURING SOLDERING):	
At distance 1/16 ± 1/32 inch (1.59 ± 0.79 mm) from case for 10 s max.	+265°C

**RECOMMENDED OPERATING CONDITIONS at T<sub>A</sub> = 25°C, Except as Noted.**

For maximum reliability, nominal operating conditions should be selected so that operation is always within the following ranges:

CHARACTERISTIC	V <sub>DD</sub> (V)	LIMITS				UNITS
		D, F, K, H PACKAGES		E PACKAGE		
		MIN.	MAX.	MIN.	MAX.	
Supply-Voltage Range (For T <sub>A</sub> = Full Package-Temperature Range)		3	12	3	12	V
Data Hold Time, t <sub>H</sub>	5 10	100 200	-	100 200	-	ns
Clock Pulse Width, t <sub>W</sub>	5 10	2.5 1	-	2.6 1.3	-	μs
Clock Input Frequency, f <sub>CL</sub>	5 10	dc	0.8	dc	0.4	MHz
Clock Rise and Fall Time, t <sub>rCL</sub> , t <sub>fCL</sub> *	5 10	-	2	-	2	μs

\* If more than one unit is cascaded in the parallel clocked application, t<sub>rCL</sub> should be made less than or equal to the sum of the propagation delay at 15 pF and the transition time of the output driving stage.

- Single phase clocking requirements
- Recirculation capability
- Data compatible with TTL-DTL
- Two cascading modes:
  - Direct clocking for high-speed operation
  - Delayed clocking for reduced clock drive requirements
- Quiescent current specified to 15 V
- Maximum input leakage current of 1 μA at 15 V (full package-temperature range)
- 1-V noise margin (full package-temperature range)

**Applications:**

- Serial shift registers
- Time delay circuits

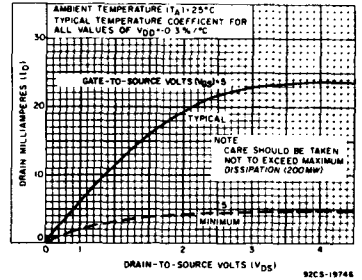

Fig. 1 - Typical and minimum output n-channel drain characteristics for Q output.

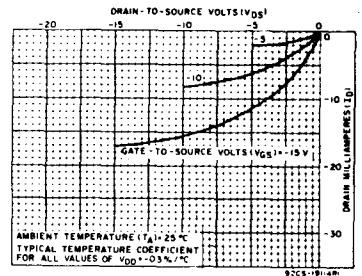

Fig. 2 - Typical output p-channel drain characteristics for Q output.

# CD4031A Types

## STATIC ELECTRICAL CHARACTERISTICS

CHARACTERISTICS	CONDITIONS			LIMITS AT INDICATED TEMPERATURES (°C)									UNITS
	V <sub>O</sub> (V)	V <sub>IN</sub> (V)	V <sub>DD</sub> (V)	D, F, K, H PACKAGES			E PACKAGE			+85			
				-55	+25	+125	-40	+25	+85				
Quiescent Device Current, I <sub>L</sub> Max.	-	-	5	10	0.5	10	600	50	1	50	700	μA	
	-	-	10	25	1	25	1500	100	2	100	1400		
	-	-	15	50	1	50	2000	500	5	500	5000		
Output Voltage: Low Level, V <sub>OL</sub>	-	5	5	0 Typ.; 0.05 Max									V
	-	10	10	0 Typ.; 0.05 Max									
High Level V <sub>OH</sub>	-	0	5	4.95 Min.; 5 Typ.									V
	-	0	10	9.95 Min.; 10 Typ.									
Noise Immunity: Inputs Low, V <sub>NL</sub>	4.2	-	5	1.5 Min.; 2.25 Typ.									V
	9	-	10	3 Min.; 4.5 Typ.									
Inputs High V <sub>NH</sub>	0.8	-	5	1.5 Min.; 2.25 Typ.									V
	1	-	10	3 Min.; 4.5 Typ.									
Noise Margin: Inputs Low, V <sub>NML</sub>	4.5	-	5	1 Min.									V
	9	-	10	1 Min.									
Inputs High, V <sub>NMH</sub>	0.5	-	5	1 Min.									V
	1	-	10	1 Min.									
Output Drive Current: N-Channel (Sink), I <sub>D</sub> N Min.	Q	0.4	-	4.5	1.6	2.6	1.3	0.91	1.6	2.6	1.3	1.05	mA
		0.5	-	10	5	8	4	3.2	5	8	4	3.2	
		0.5	-	5	0.11	0.18	0.09	0.06	0.05	0.18	0.045	0.037	
	CL <sub>D</sub>	0.5	-	10	0.24	0.4	0.2	0.14	0.12	0.4	0.1	0.08	
		0.5	-	5	0.48	0.8	0.4	0.28	0.24	0.8	0.2	0.16	
		0.5	-	10	1.5	2.4	1.2	0.84	0.75	2.4	0.6	0.5	
P-Channel (Source): I <sub>D</sub> P Min.	Q	4.5	-	5	-0.4	-0.64	-0.32	-0.22	-0.20	-0.84	-0.16	-0.13	mA
		9.5	-	10	-0.85	-1.4	-0.70	-0.49	-0.42	-1.4	-0.35	-0.29	
		4.5	-	5	-0.11	-0.18	-0.09	-0.06	-0.05	-0.18	-0.045	-0.037	
	CL <sub>D</sub>	4.5	-	10	-0.24	-0.4	-0.20	-0.14	-0.12	-0.4	-0.10	-0.08	
		4.5	-	5	-0.48	-0.8	-0.40	-0.28	-0.24	-0.8	-0.20	-0.16	
		4.5	-	10	-1	-1.6	-0.80	-0.56	-0.5	-1.6	-0.40	-0.32	
Input Leakage Current, I <sub>IL</sub> , I <sub>IH</sub>	Any Input			±10 <sup>-5</sup> Typ., ±1 Max.									μA
	-	-	15										

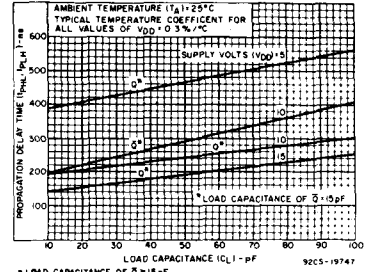

Fig. 3 - Typical propagation delay time vs. load capacitance for data outputs.

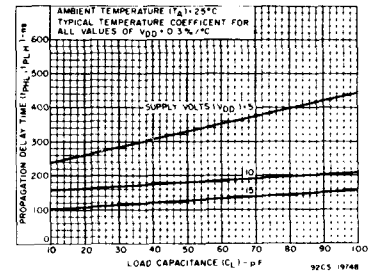

Fig. 4 - Typical propagation delay vs. load capacitance for delayed clock output.

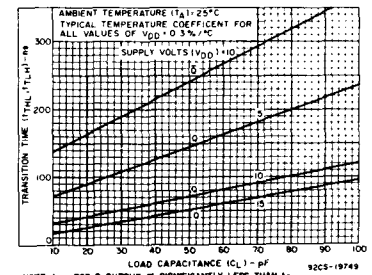

Fig. 5 - Typical transition time vs. load capacitance for data outputs.

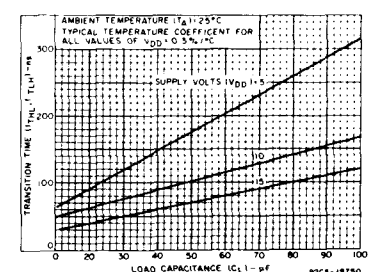

Fig. 6 - Typical transition time vs. load capacitance for delayed clock output.

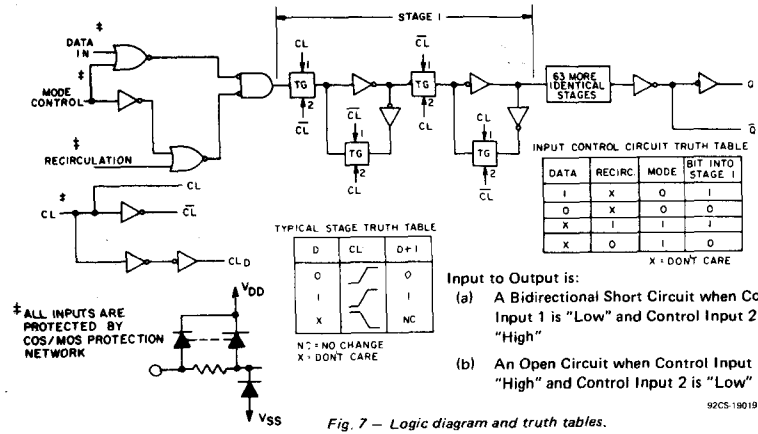

Fig. 7 - Logic diagram and truth tables.

# CD4031A Types

## DYNAMIC ELECTRICAL CHARACTERISTICS

at  $T_A=25^\circ\text{C}$ , Input  $t_r, t_f=20\text{ ns}$ ,  $C_L=15\text{ pF}$  (unless otherwise specified),  $R_L=200\text{ k}\Omega$

CHARACTERISTIC	TEST CONDITIONS	LIMITS						UNITS	
		D, F, K, H			E				
		MIN.	TYP.	MAX.	MIN.	TYP.	MAX.		
Propagation Delay Time: $t_{PLH}, t_{PHL}$ Clock to Data Output Q & $\bar{Q}$ *	$V_{DD}$ (V)	5	—	400	800	—	400	1600	ns
		10	—	200	400	—	200	800	
Clock to $CL_D$	$C_L = 60\text{ pF}$	5	—	400	800	—	400	1600	ns
		10	—	200	400	—	200	800	
Transition Time: $t_{THL}, t_{TLH}$ Q Output	$V_{DD}$ (V)	5	—	75	150	—	75	300	ns
		10	—	30	60	—	30	120	
$\bar{Q}$ Output	$V_{DD}$ (V)	5	—	300	600	—	300	1200	ns
		10	—	150	300	—	150	600	
$CL_D$ Output	$C_L = 60\text{ pF}$	5	—	200	400	—	200	800	ns
		10	—	100	200	—	100	400	
Clock Rise and Fall Time: $t_r, CL, t_f, CL^{**}$	$V_{DD}$ (V)	5	—	—	2	—	—	2	$\mu\text{s}$
		10	—	—	1	—	—	1	
Minimum Data Set-Up Time, $t_S$	$V_{DD}$ (V)	5	—	200	400	—	200	800	ns
		10	—	50	100	—	50	200	
Maximum Clock Input Frequency, $f_{CL}^{***}$	$V_{DD}$ (V)	5	0.8	2	—	0.4	2	—	MHz
		10	2	4	—	1	4	—	
Minimum Data Hold Time, $t_H$	$V_{DD}$ (V)	5	—	50	100	—	50	100	ns
		10	—	100	200	—	100	250	
Minimum Clock Pulse Width, $t_W$	$V_{DD}$ (V)	5	—	1.25	2.5	—	1.3	2.6	$\mu\text{s}$
		10	—	0.5	1	—	0.62	1.3	
Average Input Capacitance, $C_1$ Clock	$V_{DD}$ (V)	—	60	—	—	60	—	pF	
All Others	$V_{DD}$ (V)	—	5	—	—	5	—	pF	

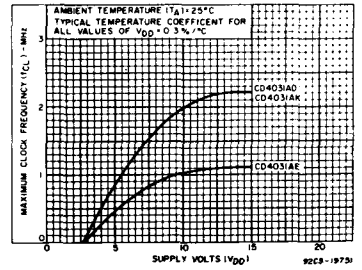

Fig. 8 — Maximum clock input frequency vs. supply voltage.

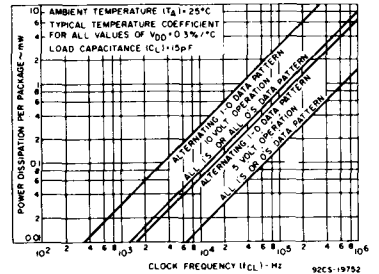

Fig. 9 — Typical power dissipation vs. frequency.

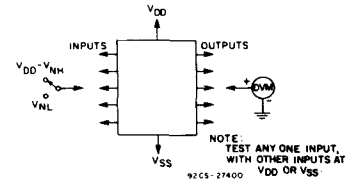

Fig. 10 — Noise-immunity test circuit.

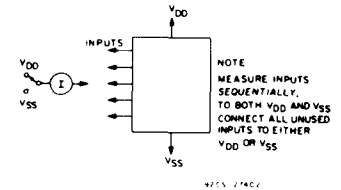

Fig. 11 — Input-leakage-current test circuit.

\* Capacitive loading on  $\bar{Q}$  output affects propagation delay of Q output. These limits apply for  $\bar{Q}$  load  $C_L \leq 15\text{ pF}$ .

\*\* If more than one unit is cascaded in the parallel clocked application,  $t_r, CL$  should be made less than or equal to the sum of the propagation delay at  $15\text{ pF}$  and the transition time of the output driving stage.

\*\*\* Maximum Clock Frequency for Cascaded Units:

a) Using Delayed Clock Feature —

$$f_{\text{max}} = \frac{1}{(n-1) CL_D \text{ prop. delay} + Q \text{ prop. delay} + \text{set-up time}}$$

where n = number of packages

b) Not Using Delayed Clock —  $f_{\text{max}} = \frac{1}{\text{propagation delay} + \text{set-up time}}$

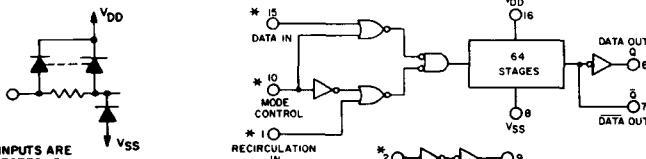

Fig. 12 — Functional diagram.

\* ALL INPUTS ARE PROTECTED BY COS/MOS PROTECTION NETWORK

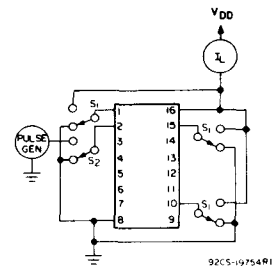

Fig. 13 — Quiescent-device-current test circuit.

# CD4032A, CD4038A Types

## CMOS Triple Serial Adders

Positive Logic Adder — CD4032A

Negative Logic Adder — CD4038A

The RCA-CD4032A and CD4038A types consist of three serial adder circuits with common CLOCK and CARRY-RESET inputs. Each adder has two provisions for two serial DATA INPUT signals and an INVERT command signal. When the command signal is a logical "1", the sum is complemented. Data words enter the adder with the least significant bit first; the sign bit trails. The output is the MOD 2 sum of the input bits plus the carry from the previous bit position. The carry is only added at the positive-going clock transition for the CD4032A or at the negative-going clock for the CD4038A, thus, for spike free operation the input data transitions should occur as soon as possible after the triggering edge.

The CARRY is reset to a logical "0" at the end of each word by applying a logical "1"

### MAXIMUM RATINGS, Absolute-Maximum Values:

STORAGE-TEMPERATURE RANGE ( $T_{stg}$ )	-65 to +150°C
OPERATING TEMPERATURE RANGE ( $T_A$ ):	
PACKAGE TYPES D, F, K, H	-55 to +125°C
PACKAGE TYPE E	-40 to +85°C
DC SUPPLY-VOLTAGE RANGE, ( $V_{DD}$ )	
(Voltages referenced to $V_{SS}$ Terminal)	-0.5 to +15 V
POWER DISSIPATION PER PACKAGE ( $P_D$ )	
FOR $T_A = -40$ to $+60^\circ\text{C}$ (PACKAGE TYPE E)	500 mW
FOR $T_A = +60$ to $+85^\circ\text{C}$ (PACKAGE TYPE E)	Derate Linearly at 12 mW/°C to 200 mW
FOR $T_A = -55$ to $+100^\circ\text{C}$ (PACKAGE TYPES D, F, K)	500 mW
FOR $T_A = +100$ to $+125^\circ\text{C}$ (PACKAGE TYPES D, F, K)	Derate Linearly at 12 mW/°C to 200 mW
DEVICE DISSIPATION PER OUTPUT TRANSISTOR	
FOR $T_A =$ FULL PACKAGE-TEMPERATURE RANGE (ALL PACKAGE TYPES)	100 mW
INPUT VOLTAGE RANGE, ALL INPUTS	0.5 to $V_{DD} + 0.5$ V
LEAD TEMPERATURE (DURING SOLDERING):	
At distance 1/16 ± 1/32 inch (1.59 ± 0.79 mm) from case for 10 s max.	+265°C

### RECOMMENDED OPERATING CONDITIONS at $T_A = 25^\circ\text{C}$ , Except as Noted.

For maximum reliability, nominal operating conditions should be selected so that operation is always within the following ranges:

CHARACTERISTIC	$V_{DD}$ (V)	LIMITS				UNITS
		D, F, K, H Packages		E Package		
		Min.	Max.	Min.	Max.	
Supply-Voltage Range (For $T_A =$ Full Package-Temperature Range)		3	12	3	12	V
Input Setup Time, $t_s$	5 10	$t_{rCL}$	-	$t_{rCL}$	-	ns
Clock Input Frequency, $f_{CL}$	5 10	dc	1.5 3	dc	2.5 5	MHz
Clock Rise or Fall Time, $t_{rCL}$ , $t_{fCL}$	5 10	-	15 15	-	15 15	μs

### Features:

- Invert inputs on all adders for sum complementing applications
- Fully static operation. . . . . dc to 5 MHz (typ.)
- Buffered outputs
- Single-phase clocking
- Microwatt quiescent power dissipation. . . . . 5 μW (typ.)
- Quiescent current specified to 15 V
- Maximum input leakage current of 1 μA at 15 V (full package-temperature range)
- 1-V noise margin (full package-temperature range)

signal to a CARRY-RESET input one bit-position before the application of the first bit of the next word. Figs. 2 and 4 show definitive waveforms for all input and output signals.

These types are supplied in 16-lead hermetic dual-in-line ceramic packages (D and F suffixes), 16-lead dual-in-line plastic package (E suffix), 16-lead ceramic flat packages (K suffix), and in chip form (H suffix).

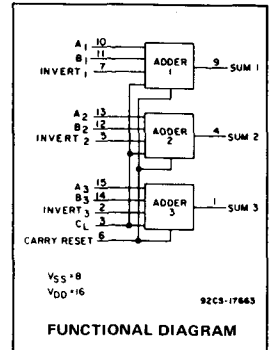

### Applications:

- Serial arithmetic units
- Digital correlators
- Digital datalink computers
- Flight control computers
- Digital servo control systems

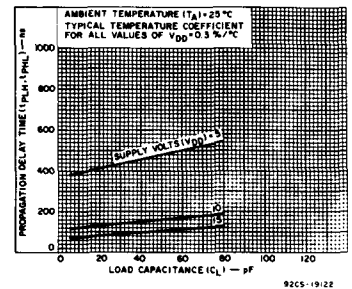

Fig. 1 — Typical propagation delay time vs. load capacitance for A, B, or INVERT inputs to sum outputs.

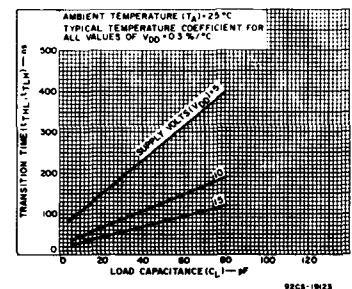

Fig. 2 — Typical transition time vs. load capacitance for sum outputs.

# CD4032A, CD4038A Types

DYNAMIC ELECTRICAL CHARACTERISTICS at  $T_A = 25^\circ\text{C}$ , Input  $t_r, t_f = 20\text{ ns}$ ,  
 $C_L = 15\text{ pF}$ ,  $R_L = 200\text{ k}\Omega$

CHARACTERISTIC	TEST CONDITIONS $V_{DD}$ (V)	LIMITS						UNITS
		D, F, K, H Packages			E Package			
		Min.	Typ.	Max.	Min.	Typ.	Max.	
Propagation Delay Time; $t_{PLH}, t_{PHL}$ A, B, or Invert Inputs to Sum Outputs	5	-	400	1100	-	400	1400	ns
	10	-	125	250	-	125	300	
Clock Input to Sum Outputs	5	-	800	2200	-	800	2400	ns
	10	-	250	500	-	250	600	
Transition Time; $t_{THL}, t_{TLH}$ (Sum Outputs)	5	-	125	375	-	125	425	ns
	10	-	50	150	-	50	200	
Maximum Clock Input Frequency, $f_{CL}$	5	1.5	2.5	-	1	2.5	-	MHz
	10	3	5	-	2	5	-	
Clock Rise & Fall Time; $t_r, t_f$	5	-	-	15	-	-	15	$\mu\text{s}$
	10	-	-	15	-	-	15	
Minimum Input Set Up Time, $t_S^*$	5	-	-	$t_r, t_f$	-	-	$t_r, t_f$	ns
	10	-	-	$t_r, t_f$	-	-	$t_r, t_f$	
Average Input Capacitance, $C_I$		-	5	-	-	5	-	pF

\*This characteristic refers to the minimum time required for the A, B, or Reset Inputs to change state following a positive clock transition (CD4032A) or negative transition (CD4038A).

\*\*if more than one unit is cascaded  $t_r, t_f$  should be made less than or equal to the sum of the transition time and the fixed propagation delay of the output of the driving stage for the estimated capacitive load.

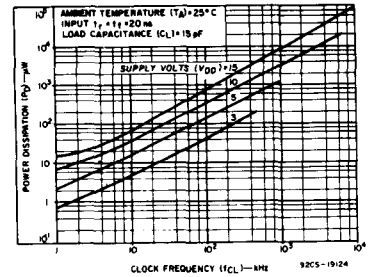

Fig. 3 - Typical dissipation characteristics.

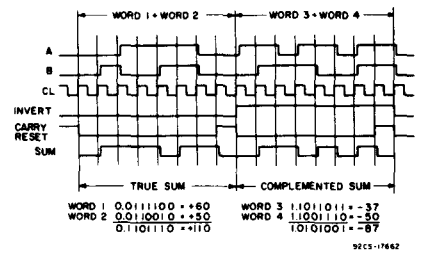

Fig. 4 - CD4032A timing diagram.

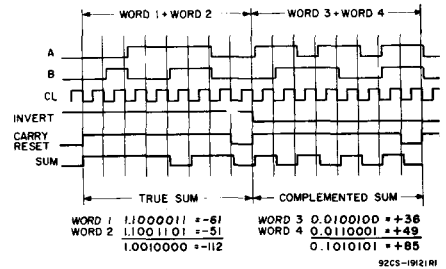

Fig. 5 - CD4038A timing diagram.

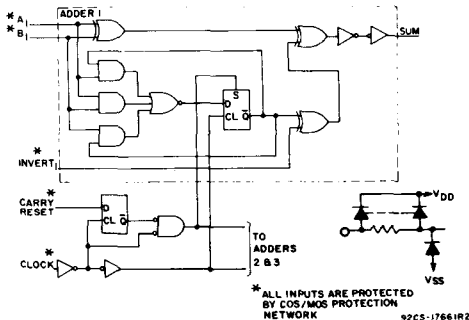

Fig. 6 - CD4032A logic diagram of one of three serial adders.

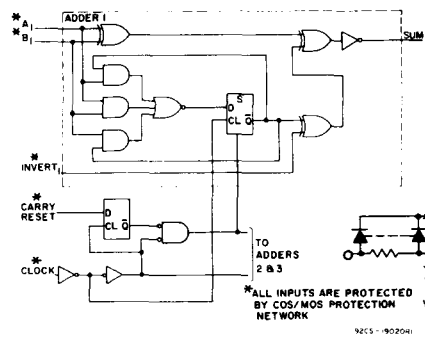

Fig. 7 - CD4038A logic diagram of one of three serial adders.

# CD4032A, CD4038A Types

## STATIC ELECTRICAL CHARACTERISTICS

Characteristic	Conditions			Limits at Indicated Temperatures (°C)								Units
				D, F, K, H Packages				E Package				
	V <sub>O</sub> (V)	V <sub>IN</sub> (V)	V <sub>DD</sub> (V)	-55	+25		+125	-40	+25		+85	
				Typ.	Limit			Typ.	Limit			
Quiescent Device Current I <sub>L</sub> Max.	-	-	5	5	0.3	5	300	50	0.5	50	700	μA
	-	-	10	10	0.5	10	600	100	1	100	1400	
	-	-	15	50	1	50	2000	500	5	500	5000	
Output Voltage: Low-Level V <sub>OL</sub>	-	5	5	0 Typ.; 0.05 Max.								V
	-	10	10	0 Typ.; 0.05 Max.								
	-	0	5	4.95 Min.; 5 Typ.								
High Level V <sub>OH</sub>	-	0	10	9.95 Min.; 10 Typ.								V
	-	0	10	9.95 Min.; 10 Typ.								
Noise Immunity: Inputs Low, V <sub>NL</sub>	4.2	-	5	1.5 Min.; 2.25 Typ.								V
	9	-	10	3 Min.; 4.5 Typ.								
Inputs High V <sub>NH</sub>	0.8	-	5	1.5 Min.; 2.25 Typ.								V
	1	-	10	3 Min.; 4.5 Typ.								
Noise Margin: Inputs Low, V <sub>NML</sub>	4.5	-	5	1 Min.								V
	9	-	10	1 Min.								
	0.5	-	5	1 Min.								
Inputs High, V <sub>NMH</sub>	1	-	10	1 Min.								V
	1	-	10	1 Min.								
Output Drive Current N-Channel (Sink), I <sub>DN</sub> Min.	0.5	-	5	0.6	0.9	0.5	0.3	0.25	0.9	0.2	0.14	mA
	0.5	-	10	0.75	2.4	0.7	0.6	0.6	2.4	0.5	0.4	
P-Channel (Source), I <sub>DP</sub> Min.	4.5	-	5	-0.21	-0.4	-0.15	-0.075	-0.14	-0.4	-0.1	-0.095	mA
	9.5	-	10	-0.7	-7.2	-0.55	-0.35	-0.3	-1.2	-0.27	-0.22	
Input Leakage Current, I <sub>IL</sub> , I <sub>IH</sub>	Any Input			±10 <sup>-5</sup> Typ., ±1 Max.								μA
	-	-	15									

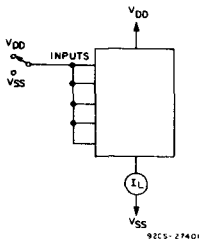

Fig. 8 - Quiescent-device-current test circuit.

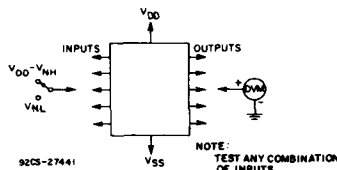

Fig. 9 - Noise-immunity test circuit.

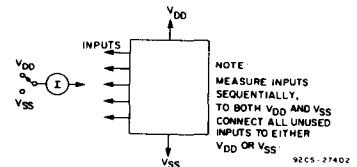

Fig. 10 - Input-leakage-current test circuit.



# CD4034A Types

**Table I – Truth Table for Register Input Levels and the Resulting Register Operation (L = Low Level, H = High Level, X = Don't Care)**

"A" Enable	P/S	A/B	A/S	Operation*
L	L	L	X	Serial Mode; Synch. Serial Data Input, "A" Parallel Data Outputs Disabled
L	L	H	X	Serial Mode; Synch. Serial Data Input, "B" Parallel Data Output
L	H	L	L	Parallel Mode; "B" Synch. Parallel Data Inputs, "A" Parallel Data Outputs Disabled
L	H	L	H	Parallel Mode; "B" Asynch. Parallel Data Inputs, "A" Parallel Data Outputs Disabled
L	H	H	L	Parallel Mode; "A" Parallel Data Inputs Disabled, "B" Parallel Data Outputs, Synch. Data Recirculation
L	H	H	H	Parallel Mode; "A" Parallel Data Inputs Disabled, "B" Parallel Data Outputs, Asynch. Data Recirculation
H	L	L	X	Serial Mode; Synch. Serial Data Input, "A" Parallel Data Output
H	L	H	X	Serial Mode; Synch. Serial Data Input, "B" Parallel Data Output
H	H	L	L	Parallel Mode; "B" Synch. Parallel Data Input, "A" Parallel Data Output
H	H	L	H	Parallel Mode; "B" Asynch. Parallel Data Input, "A" Parallel Data Output
H	H	H	L	Parallel Mode; "A" Synch. Parallel Data Input, "B" Parallel Data Output
H	H	H	H	Parallel Mode; "A" Asynch. Parallel Data Input, "B" Parallel Data Output

\*Outputs change at positive transition of clock in the serial mode and when the A/S control input is "low" in the parallel mode.

### Features:

- Bidirectional parallel data input
- Parallel or serial inputs/parallel outputs
- Asynchronous or synchronous parallel data loading
- Parallel data-input enable on "A" data lines
- Data recirculation for register expansion
- Multipackage register expansion
- Fully static operation DC-to-5 MHz (typ.) At  $V_{DD}-V_{SS} = 10\text{ V}$
- Quiescent current specified to 15  $\mu\text{A}$
- Maximum input leakage current of 1  $\mu\text{A}$  at 15 V (full package-temperature range)
- 1-V noise margin (full package-temperature range)

### Applications:

- Parallel Input/Parallel Output, Parallel Input/Serial Output, Serial Input/Parallel Output, Serial Input/Serial Output Register
- Shift right/shift left register
- Shift right/shift left with parallel loading
- Address register
- Buffer register
- Bus system register with enable parallel lines at bus side
- Double bus register system
- Up-Down Johnson or ring counter
- Pseudo-random code generators
- Sample and hold register (storage, counting, display)
- Frequency and phase comparator

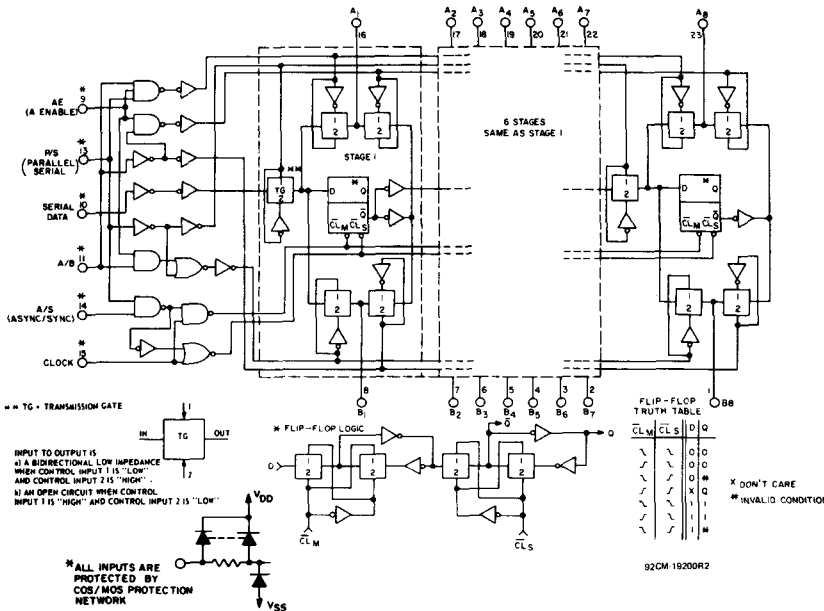

Fig. 2 – Logic diagram.

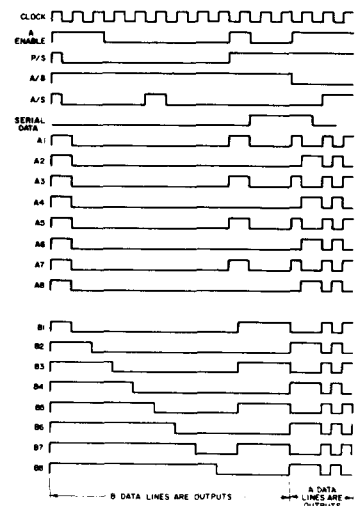

Fig. 3 – Timing diagram.



## STATIC ELECTRICAL CHARACTERISTICS

CHARACTERISTICS	CONDITIONS			LIMITS AT INDICATED TEMPERATURES (°C)								UNITS
				D, F, K, H PACKAGES				E PACKAGE				
	V <sub>O</sub> (V)	V <sub>IN</sub> (V)	V <sub>DD</sub> (V)	-55	+25 TYP. LIMIT	+125	-40	+25 TYP. LIMIT	+85			
Quiescent Device Current, I <sub>L</sub> Max.	-	-	5	5	0.3	5	300	50	0.5	50	700	μA
	-	-	10	10	0.5	10	600	100	1	100	1400	
	-	-	15	50	1	50	2000	500	5	500	5000	
Output Voltage: Low Level, V <sub>OL</sub>	-	5	5	0 Typ.; 0.05 Max								V
	-	10	10	0 Typ.; 0.05 Max								
	-	0	5	4.95 Min.; 5 Typ.								
High Level V <sub>OH</sub>	-	0	5	9.95 Min.; 10 Typ.								V
	-	0	10	9.95 Min.; 10 Typ.								
Noise Immunity: Inputs Low, V <sub>NL</sub>	4.2	-	5	1.5 Min.; 2.25 Typ.								V
	9	-	10	3 Min.; 4.5 Typ.								
Inputs High V <sub>NH</sub>	0.8	-	5	1.5 Min.; 2.25 Typ.								V
	1	-	10	3 Min.; 4.5 Typ.								
Noise Margin: Inputs Low, V <sub>NML</sub>	4.5	-	5	1 Min.								V
	9	-	10	1 Min.								
	0.5	-	5	1 Min.								
Inputs High, V <sub>NMH</sub>	1	-	10	1 Min.								V
	1	-	10	1 Min.								
Output Drive Current: N-Channel (Sink), I <sub>O</sub> N Min.	0.5	-	5	0.124	0.2	0.1	0.07	0.124	0.2	0.1	0.07	mA
	0.5	-	10	0.31	0.5	0.25	0.175	0.31	0.5	0.25	0.175	
	4.5	-	5	-0.075	-0.1	-0.05	-0.035	-0.075	-0.1	-0.05	-0.035	
P-Channel (Source): I <sub>O</sub> P Min.	9.5	-	10	-0.188	-0.25	-0.125	-0.088	-0.188	-0.25	-0.125	-0.088	mA
	9.5	-	10	-0.188	-0.25	-0.125	-0.088	-0.188	-0.25	-0.125	-0.088	
Input Leakage Current, I <sub>IL</sub> , I <sub>IH</sub>	-	-	15	±10 <sup>-5</sup> Typ., ±1 Max.								μA

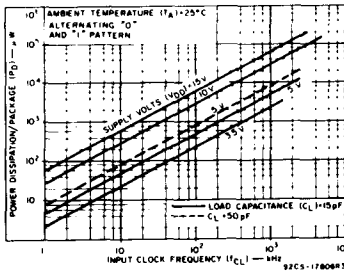

Fig. 7 - Typical dissipation characteristics.

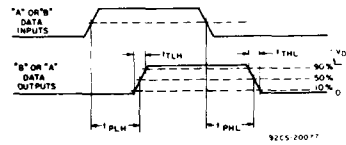

Fig. 8 - Asynchronous operation propagation delay time and transition time.

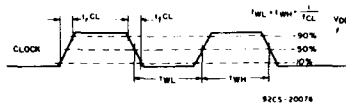

Fig. 9 - Clock pulse rise and fall times.

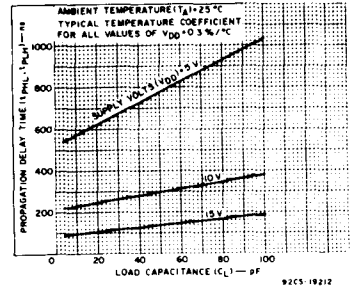

Fig. 4 - Typical propagation delay time vs. load capacitance.

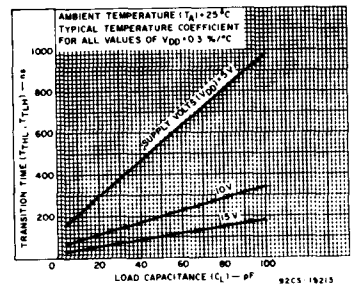

Fig. 5 - Typical transition time vs. load capacitance.

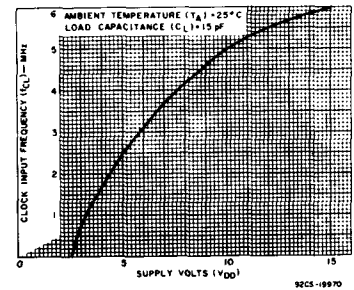

Fig. 6 - Typical supply input frequency vs. supply voltage.

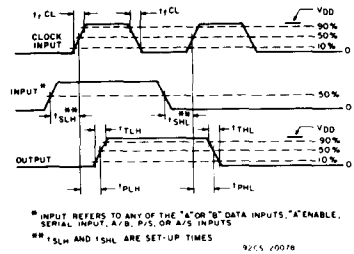

Fig. 10 - Synchronous operation propagation delay times, transition times, and set-up times.

# CD4034A Types

## DYNAMIC ELECTRICAL CHARACTERISTICS

At  $T_A = 25^\circ\text{C}$ , Input  $t_r, t_f = 20\text{ ns}$ ,  $C_L = 15\text{ pF}$ ,  $R_L = 200\text{ k}\Omega$

CHARACTERISTIC	TEST CONDITIONS	LIMITS						UNIT	
		$V_{DD}$ (V)	D, F, K, H PACKAGES			E PACKAGE			
			MIN.	TYP.	MAX.	MIN.	TYP.		MAX.
Propagation Delay Time: $t_{PLH}, t_{PHL}$		5	-	600	1200	-	600	1200	ns
		10	-	240	480	-	240	480	
Transition Time; $t_{THL}, t_{TLH}$		5	-	250	750	-	250	750	ns
		10	-	100	300	-	100	300	
Maximum Clock Input Frequency, $f_{CL}$		5	1.5	2.5	-	1.5	2.5	-	MHz
		10	3	5	-	3	5	-	
Clock Pulse Width, $t_W$		5	-	200	400	-	200	400	ns
		10	-	100	175	-	100	175	
Min. High-Level AE, P/S, A/S Pulse Width		5	-	240	480	-	240	480	ns
		10	-	85	195	-	85	195	
Clock Rise & Fall Time $t_{rCL}, t_{fCL}^*$		5	-	-	15	-	-	15	$\mu\text{s}$
		10	-	-	15	-	-	15	
Data Set-Up Time, $t_S$		5	-	250	500	-	250	500	ns
		10	-	100	200	-	100	200	
Average Input Capacitance, $C_I$	Any Input	-	-	5	-	-	5	-	pF

\*If more than one unit is cascaded  $t_{rCL}$  should be made less than or equal to the sum of the transition time and the fixed propagation delay of the output of the driving stage for the estimated capacitive load.

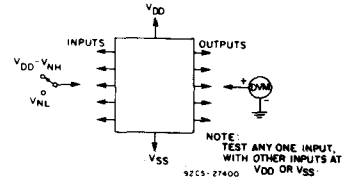

Fig. 11 - Noise-immunity test circuit.

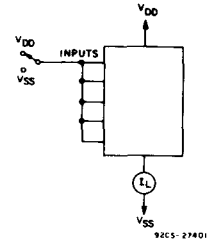

Fig. 12 - Quiescent-device-current test circuit.

## APPLICATIONS

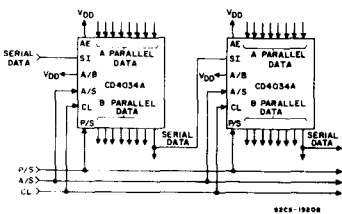

Fig. 14 - 16-Bit parallel in/parallel out, parallel in/serial out, serial in/parallel out, serial in/serial out register.

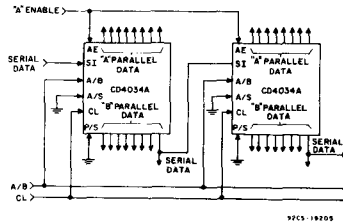

Fig. 15 - 16-Bit serial in/gated parallel out register.

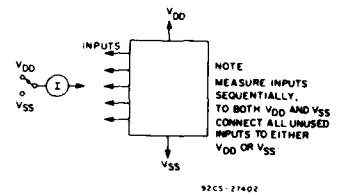

Fig. 13 - Input-leakage-current test circuit.

# CMOS 4-Stage Parallel In/Parallel Out Shift Register

with J-K Serial Inputs and True/ Complement Outputs

**Features:**

- 4-Stage clocked shift operation
- Synchronous parallel entry on all 4 stages
- JK inputs on first stage
- Asynchronous True/Complement control on all outputs
- Static flip-flop operation; Master-slave configuration
- Reset control
- Buffered outputs
- Low power dissipation — 5µW typ. (ceramic)
- High speed — to 5 MHz
- Quiescent current specified to 15 V
- Maximum input leakage current of 1µA at 15 V (full package-temperature range)
- 1-V noise margin (full package-temperature range)

The RCA-CD4035A is a four-stage clocked signal serial register with provision for SYNCHRONOUS PARALLEL inputs to each stage and SERIAL inputs to the first stage via JK logic. Register stages 2, 3, and 4 are coupled in a serial D flip-flop configuration when the register is in the serial mode (PARALLEL/SERIAL control low).

Parallel entry via the D line of each register stage is permitted only when the PARALLEL/SERIAL control is high.

In the parallel or serial mode information is transferred on positive clock transitions.

When the TRUE/COMPLEMENT control is high, the TRUE contents of the register are available at the output terminals. When the TRUE/COMPLEMENT control is low, the outputs are the complements of the data in the register. The TRUE/COMPLEMENT control functions asynchronously with respect to the CLOCK signal.

JK input logic is provided on the first stage SERIAL input to minimize logic requirements particularly in counting and sequence-generation applications. With JK inputs connected together, the first stage becomes a D flip-flop. An asynchronous common RESET is also provided.

These types are supplied in 16-lead hermetic dual-in-line ceramic packages (D and F suffixes), 16-lead dual-in-line plastic package (E suffix), 16-lead ceramic flat packages (K suffix), and in chip form (H suffix).

**Applications**

- Counters, Registers
- Arithmetic-unit registers
- Shift left — shift right registers
- Serial-to-parallel/parallel-to-serial conversions
- Sequence generation
- Control circuits
- Code conversion

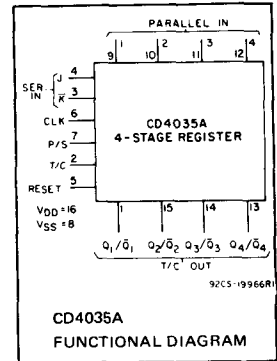

**MAXIMUM RATINGS, Absolute-Maximum Values:**

STORAGE-TEMPERATURE RANGE (T <sub>stg</sub> )	.....	-66 to +150°C
OPERATING-TEMPERATURE RANGE (T <sub>A</sub> ):		
PACKAGE TYPES D, F, K, H	.....	-55 to +125°C
PACKAGE TYPE E	.....	-40 to +85°C
DC SUPPLY-VOLTAGE RANGE, (V <sub>DD</sub> )		
(Voltages referenced to V <sub>SS</sub> Terminal):	.....	-0.5 to +15V
POWER DISSIPATION PER PACKAGE (P <sub>D</sub> ):		
FOR T <sub>A</sub> = -40 to +60°C (PACKAGE TYPE E)	.....	500 mW
FOR T <sub>A</sub> = +60 to +85°C (PACKAGE TYPE E)	.....	Derate Linearly at 12mW/°C to 200 mW
FOR T <sub>A</sub> = -55 to +100°C (PACKAGE TYPES D, F, K)	.....	500 mW
FOR T <sub>A</sub> = +100 to +125°C (PACKAGE TYPES D, F, K)	.....	Derate Linearly at 12mW/°C to 200 mW
DEVICE DISSIPATION PER OUTPUT TRANSISTOR		
FOR T <sub>A</sub> = FULL PACKAGE-TEMPERATURE RANGE (ALL PACKAGE TYPES)	.....	100mW
INPUT VOLTAGE RANGE, ALL INPUTS	.....	-0.5 to V <sub>DD</sub> +0.5V
LEAD TEMPERATURE (DURING SOLDERING):		
At distance 1/16 ± 1/32 inch (1.59 ± 0.79 mm) from case for 10 s max	.....	+265°C

**RECOMMENDED OPERATING CONDITIONS at T<sub>A</sub>=25°C, except as noted.**

For maximum reliability, nominal operating conditions should be selected so that operation is always within the following ranges:

CHARACTERISTIC	V <sub>DD</sub> (V)	LIMITS				UNITS
		D, F, K, H PACKAGES		E PACKAGE		
		MIN.	MAX.	MIN.	MAX.	
Supply Voltage Range (For T <sub>A</sub> = Full Package-Temperature Range)		3	12	3	12	V
Data Setup Time, t <sub>S</sub> :						ns
JK Lines	5 10	500 200	— —	750 250	— —	
Parallel-In Lines	5 10	350 80	— —	500 100	— —	
Clock Pulse Width, t <sub>W</sub>	5 10	335 165	— —	500 250	— —	ns
Clock Rise and Fall Time, t <sub>r,CL</sub> , t <sub>f,CL</sub>	5 10	— —	15 5	— —	15 5	µs
Reset Pulse Duration, t <sub>W</sub>	5 10	400 175	— —	500 200	— —	ns

# CD4035A Types

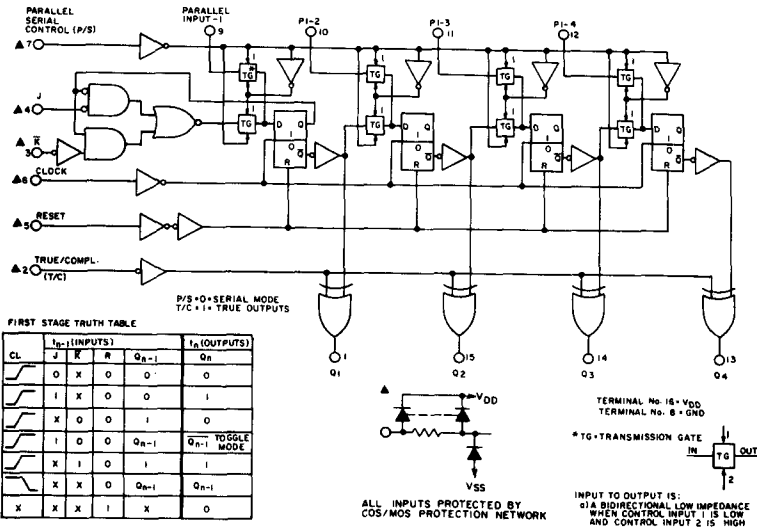

Fig. 1 - Logic block diagram.

## STATIC ELECTRICAL CHARACTERISTICS

CHARACTERISTICS	CONDITIONS			LIMITS AT INDICATED TEMPERATURES (°C)							UNITS	
				D, F, K, H PACKAGES				E PACKAGE				
				-55	+25		-40	+25		+85		
Quiescent Device Current, $I_L$ Max.	$V_O$	$V_{IN}$	$V_{DD}$	5	0.3	5	300	50	0.5	50	700	$\mu A$
	-	-	5	10	0.5	10	600	100	1	100	1400	
	-	-	15	50	1	50	2000	500	5	500	5000	
Output Voltage: Low Level, $V_{OL}$	-	5	5	0 Typ.; 0.05 Max							V	
	-	10	10	0 Typ.; 0.05 Max								
High Level, $V_{OH}$	-	0	5	4.95 Min.; 5 Typ.							V	
	-	0	10	9.95 Min.; 10 Typ.								
Noise Immunity: Inputs Low, $V_{NL}$	4.2	-	5	1.5 Min.; 2.25 Typ.							V	
	9	-	10	3 Min.; 4.5 Typ.								
Inputs High, $V_{NH}$	0.8	-	5	1.5 Min.; 2.25 Typ.							V	
	1	-	10	3 Min.; 4.5 Typ.								
Noise Margin: Inputs Low, $V_{NML}$	4.5	-	5	1 Min.							V	
	9	-	10	1 Min.								
Inputs High, $V_{NMH}$	0.5	-	5	1 Min.							V	
	1	-	10	1 Min.								
Output Drive Current: N-Channel (Sink), $I_{DN}$ Min.	0.5	-	5	0.62	1	0.5	0.35	0.43	1	0.35	0.24	mA
	0.5	-	10	1.55	2.5	1.25	0.87	1.05	2.5	0.85	0.59	
P-Channel (Source), $I_{DP}$ Min.	4.5	-	5	-0.31	-0.5	-0.25	-0.17	-0.2	-0.5	-0.18	-0.12	mA
	9.5	-	10	-0.81	-1.3	-0.65	-0.45	-0.56	-0.31	-0.45	-0.31	
Input Leakage Current, $I_{IL}$ , $I_{IH}$	Any Input			$\pm 10^{-5}$ Typ., $\pm 1$ Max.							$\mu A$	

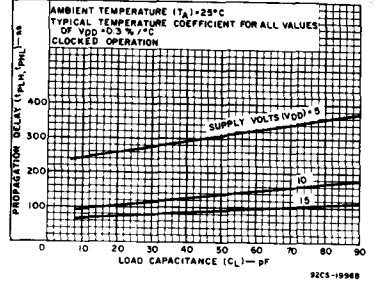

Fig. 2 - Typical propagation delay time vs. load capacitance.

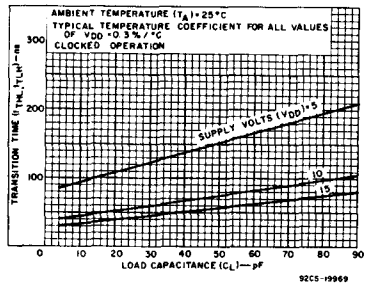

Fig. 3 - Typical transition time vs. load capacitance.

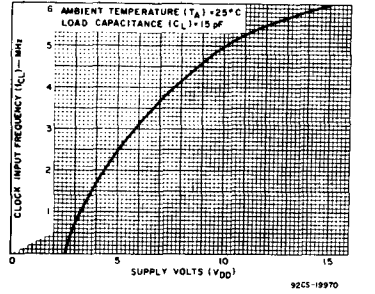

Fig. 4 - Typical clock input frequency vs. supply voltage.

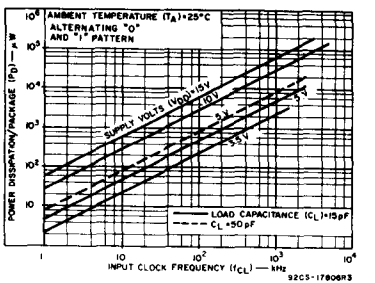

Fig. 5 - Typical dynamic power dissipation characteristics.

DYNAMIC ELECTRICAL CHARACTERISTICS

At  $T_A = 25^\circ\text{C}$ , Input  $t_r, t_f = 20 \text{ ns}$ ,  $C_L = 15 \text{ pF}$ ,  $R_L = 200 \text{ k}\Omega$

CHARACTERISTICS	TEST CONDITIONS	LIMITS						UNITS	
		D, F, K, H PACKAGES			E PACKAGE				
		$V_{DD}$ (V)	Min.	Typ.	Max.	Min.	Typ.		Max.
<b>CLOCKED OPERATION</b>									
Propagation Delay Time: $t_{PLH}, t_{PHL}$		5	-	250	500	-	250	700	ns
		10	-	100	200	-	100	300	
Transition Time: $t_{THL}, t_{TLH}$		5	-	100	200	-	100	300	ns
		10	-	50	100	-	50	150	
Minimum Clock Pulse Width, $t_W$		5	-	200	335	-	200	500	ns
		10	-	100	165	-	100	250	
Maximum Clock Rise & Fall Time $t_{rCL}, t_{fCL}^*$		5	-	-	15	-	-	15	$\mu\text{s}$
		10	-	-	5	-	-	5	
Minimum Setup Time: J/K Lines		5	-	250	500	-	250	750	ns
		10	-	100	200	-	100	250	
Parallel-In Lines		5	-	100	350	-	100	500	ns
		10	-	50	80	-	50	100	
Maximum Clock Frequency, $f_{CL}$		5	1.5	2.5	-	1	2.5	-	$\text{MHz}$
		10	3	5	-	2	5	-	
Input Capacitance, $C_I$	Any Input	-	5	-	-	5	-	pF	
<b>RESET OPERATION</b>									
Propagation Delay Time: $t_{PHL}, t_{PLH}$		5	-	250	500	-	250	700	ns
		10	-	100	200	-	100	300	
Minimum Reset Pulse Width, $t_W$		5	-	200	400	-	200	500	ns
		10	-	100	175	-	100	200	

\*If more than one unit is cascaded  $t_{rCL}$  should be made less than or equal to the sum of the transition time and the fixed propagation delay of the output of the driving stage for the estimated capacitive load.

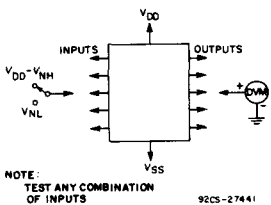

Fig. 6 - Noise-immunity test circuit.

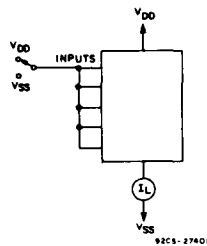

Fig. 7 - Quiescent-device-current test circuit.

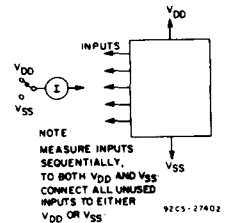

Fig. 8 - Input-leakage-current test circuit.

## CD4037A Types

# CMOS Triple AND/OR Bi-Phase Pairs

The RCA-CD4037A consists of three AND/OR pairs driven by common control signals A and B.

Each circuit has a data input (C), and two output terminals (D and E) that provide outputs in accordance with the truth table shown in Fig. 1. The circuit is useful for coding or decoding signals for split-phase (Bi-phase) communication systems, magnetic recording, and plated wire and core memory systems. A separate  $V_{CC}$  terminal is provided to allow level conversion to any voltage from 3 volts to  $V_{DD}$ .

These types are supplied in 14-lead hermetic dual-in-line ceramic packages (D and F suffixes), 14-lead dual-in-line plastic package (E suffix), 14-lead ceramic flat package (K suffix), and in chip form (H suffix).

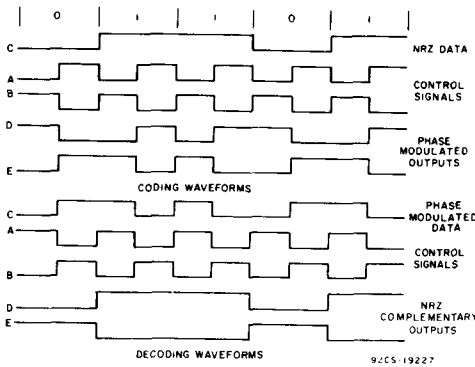
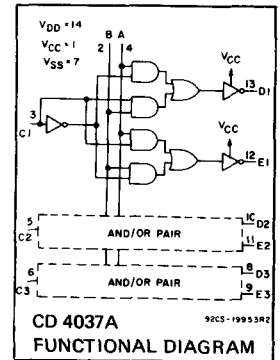
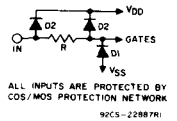

Fig. 1 - Coding and decoding waveforms.



TRUTH TABLE

INPUT	A	B	D	E
0	0	1	1	1
1	0	0	0	0
0	1	0	0	0
1	1	1	0	0



ALL INPUTS ARE PROTECTED BY CMOS/MOS PROTECTION NETWORK  
92CS-22887R1

**RECOMMENDED OPERATING CONDITIONS.** For maximum reliability, nominal operating conditions should be selected to that operation is always within the following ranges:

CHARACTERISTIC	$V_{DD}$ (V)	LIMITS				UNITS
		D, F, K, H PACKAGES		E PACKAGE		
		MIN.	MAX.	MIN.	MAX.	
Supply-Voltage Range (For $T_A$ = Full Package-Temperature Range)		3	12	3	12	V

**CAUTION:**  $V_{CC}$  VOLTAGE LEVEL MUST BE EQUAL TO OR LESS POSITIVE THAN  $V_{DD}$

### DYNAMIC ELECTRICAL CHARACTERISTICS

at  $T_A = 25^\circ\text{C}$ , Input  $t_r, t_f = 20\text{ ns}$ ,  $C_L = 15\text{ pF}$ ,  $R_L = 200\text{ k}\Omega$

CHARACTERISTIC	TEST CONDITIONS	LIMITS						UNITS	
		D, F, K, H PACKAGES			E PACKAGE				
		$V_{DD}$ (V)	MIN.	TYP.	MAX.	MIN.	TYP.		MAX.
Propagation Delay Time: A and B Inputs $t_{PHL}, t_{PLH}$		5	—	225	450	—	325	650	ns
		10	—	75	150	—	100	200	
C Inputs $t_{PHL}$ $t_{PLH}$		5	—	250	500	—	350	700	ns
		10	—	75	150	—	100	200	
		5	—	225	450	—	325	650	
		10	—	90	180	—	125	250	
Transition Time: High-to-Low Level, $t_{THL}$		5	—	40	80	—	60	120	ns
		10	—	15	30	—	20	40	
Low-to-High Level, $t_{TLH}$		5	—	75	150	—	100	200	ns
		10	—	60	120	—	90	180	
Input Capacitance, $C_i$	Any Input	—	5	—	—	—	5	—	pF

### Features:

- Outputs compatible with low-power TTL systems.
- High sink and source current (1.6 mA typ.) capability at  $V_{DD} = V_{CC} = 10\text{V}$  and  $V_{DS} = 0.5\text{V}$ .
- Microwatt quiescent power dissipation:  $P_D = 0.5\text{ }\mu\text{W/ceramic pkg. (typ.)}$ ,  $P_D = 2\text{ }\mu\text{W/plastic pkg. (typ.)}$  at  $V_{DD} = 10\text{V}$
- Quiescent current specified to 15 V
- Maximum input leakage current of 1  $\mu\text{A}$  at 15 V (full package-temperature range)
- 1-V noise margin (full package-temperature range)

### Applications:

- Split-phase (Bi-Phase) communication systems.
- Disc, drum, and tape digital recording systems.
- Plated wire and core memory systems.
- High-to-low logic level converter.

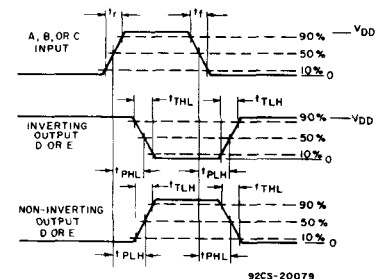

Fig. 2 - Waveforms for measurement of dynamic characteristics.

# CD4037A Types

## MAXIMUM RATINGS, Absolute-Maximum Values:

STORAGE-TEMPERATURE RANGE ( $T_{stg}$ )	.....	-65 to +150 °C
OPERATING-TEMPERATURE RANGE ( $T_A$ ):		
PACKAGE TYPES D, F, K, H	.....	-55 to +125 °C
PACKAGE TYPE E	.....	-40 to +85 °C
DC SUPPLY-VOLTAGE RANGE, ( $V_{DD}$ )		
(Voltages referenced to $V_{SS}$ Terminal)	.....	-0.5 to +15 V
POWER DISSIPATION PER PACKAGE ( $P_D$ ):		
FOR $T_A = -40$ to $+60$ °C (PACKAGE TYPE E)	.....	500 mW
FOR $T_A = +60$ to $+85$ °C (PACKAGE TYPE E)	.....	Derate Linearly at 12 mW/°C to 200 mW
FOR $T_A = -55$ to $+100$ °C (PACKAGE TYPES D, F, K)	.....	500 mW
FOR $T_A = +100$ to $+125$ °C (PACKAGE TYPES D, F, K)	.....	Derate Linearly at 12 mW/°C to 200 mW
DEVICE DISSIPATION PER OUTPUT TRANSISTOR		
FOR $T_A =$ FULL PACKAGE-TEMPERATURE RANGE (ALL PACKAGE TYPES)	.....	100 mW
INPUT VOLTAGE RANGE, ALL INPUTS	.....	-0.5 to $V_{DD} + 0.5$ V
LEAD TEMPERATURE (DURING SOLDERING):		
At distance 1/16 ± 1/32 inch (1.59 ± 0.79 mm) from case for 10 s max	.....	+265 °C

## STATIC ELECTRICAL CHARACTERISTICS

CHARACTERISTICS	CONDITIONS			LIMITS AT INDICATED TEMPERATURES (°C)								UNITS
				D, F, K, H PACKAGES				E PACKAGE				
				-55	+25		+125	-40	+25		+85	
Quiescent Device Current, $I_L$ Max.	$V_O$	$V_{IN}$	$V_{DD}$	5	0.03	5	300	50	0.1	50	700	$\mu A$
	-	-	5	10	0.05	10	600	100	0.2	100	1400	
	-	-	15	50	1	50	2000	500	5	500	5000	
Output Voltage: Low Level, $V_{OL}$	-	5	5	0 Typ.; 0.05 Max								V
	-	10	10	0 Typ.; 0.05 Max								
High Level $V_{OH}$	-	0	5	4.95 Min.; 5 Typ.								V
	-	0	10	9.95 Min.; 10 Typ.								
Noise Immunity: Inputs Low, $V_{NL}$	4.2	-	5	1.5 Min.; 2.25 Typ.								V
	9	-	10	3 Min.; 4.5 Typ.								
Inputs High $V_{NH}$	0.8	-	5	1.5 Min.; 2.25 Typ.								V
	1	-	10	3 Min.; 4.5 Typ.								
Noise Margin: Inputs Low, $V_{NML}$	4.5	-	5	1 Min.								V
	9	-	10	1 Min.								
Inputs High, $V_{NMH}$	0.5	-	5	1 Min.								V
	1	-	10	1 Min.								
Output Drive Current: N-Channel (Sink), $I_D$ Min.	0.5	-	5	0.85	0.7	1.2	0.45	0.4	0.35	0.7	0.3	mA
	0.5	-	10	1.3	1.1	2	0.7	0.65	0.55	1.1	0.45	
	P-Channel (Source): $I_D$ Min.	4.5	-	5	-0.65	-0.55	-1	-0.35	-0.35	-0.3	-0.55	
9.5		-	10	-0.9	-0.75	-1.6	-0.45	-0.5	-0.4	-0.75	-0.3	
Input Leakage Current, $I_{IL}, I_{IH}$	Any Input			$\pm 10^{-5}$ Typ., $\pm 1$ Max.								$\mu A$

For quiescent device current, noise immunity, and input leakage current test circuits see "Ratings and Characteristics" at the beginning of the CMOS section.

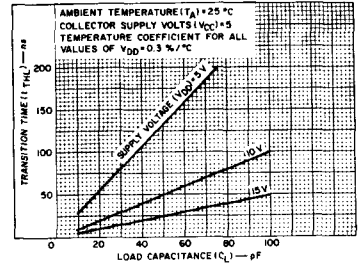

Fig. 3 - Typical transition time vs. load capacitance.

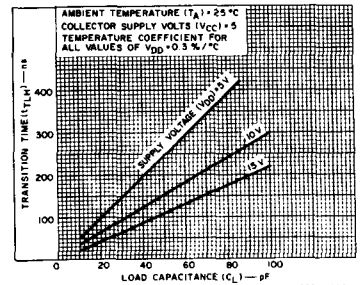

Fig. 4 - Typical transition time vs. load capacitance.

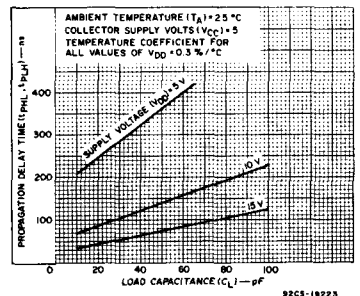

Fig. 5 - Typical propagation delay time vs. load capacitance.

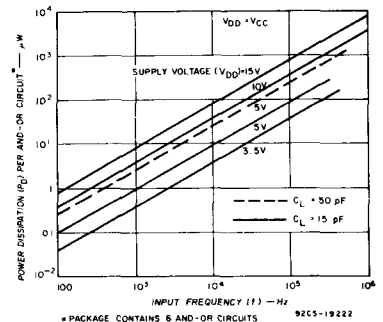

Fig. 6 - Typical dissipation characteristics.

# CD4040A Types

## CMOS 12-Stage Ripple-Carry Binary Counter/Divider

The RCA-CD4040A consists of an input-pulse-shaping circuit and 12 ripple-carry binary counter stages. Resetting the counter to the all-0's state is accomplished by a high-level on the reset line. A master-slave flip-flop configuration is utilized for each counter stage. The state of the counter is advanced one step in binary order on the negative-going transition of the input pulse. All inputs and outputs are fully buffered.

These types are supplied in 16-lead hermetic dual-in-line ceramic packages (D and F suffixes), 16-lead dual-in-line plastic package (E suffix), 16-lead ceramic flat package (K suffix), and in chip form (H suffix).

### Features:

- Medium-speed operation . . . 5 MHz (typ.) input pulse rate at  $V_{DD} - V_{SS} = 10\text{ V}$
- Low output impedance . . .  $750\ \Omega$  (typ.) at  $V_{DD} - V_{SS} = 10\text{ V}$  and  $V_{DS} = 0.5\text{ V}$
- Common reset
- Fully static operation
- All 12 buffered outputs available
- Low-power TTL compatible
- Quiescent current specified to 15 V
- Maximum input leakage current of  $1\ \mu\text{A}$  at 15 V (full package-temperature range)
- 1-V noise margin (full package-temperature range)

### Applications:

- Frequency-dividing circuits
- Time-delay circuits
- Control counters

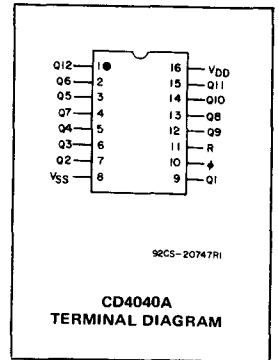

**RECOMMENDED OPERATING CONDITIONS** at  $T_A = 25^\circ\text{C}$ , Except as Noted:  
For maximum reliability, nominal operating conditions should be selected so that operation is always within the following ranges :

CHARACTERISTIC	$V_{DD}$ (V)	LIMITS				UNITS
		D, F, K, H Packages		E Package		
		Min.	Max.	Min.	Max.	
Supply Voltage Range (For $T_A = \text{Full Package-Temperature Range}$ )		3	12	3	12	V
Input Pulse Width, $t_W$	5 10	400 110	— —	500 125	— —	ns
Input-Pulse Frequency, $f_\phi$	5 10	dc dc	1.5 4	dc dc	1.5 4	MHz
Input-Pulse Rise or Fall Time, $t_{r\phi}, t_{f\phi}$	5 10	15 15	— —	15 15	— —	$\mu\text{s}$
Reset Pulse Width, $t_W$	5 10	1000 500	— —	1250 600	— —	ns

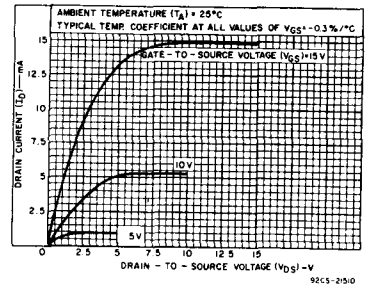

Fig.2 — Typical output n-channel drain characteristics.

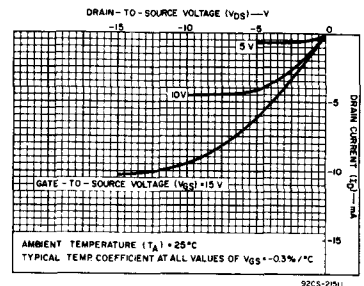

Fig.3 — Typical output p-channel drain characteristics.

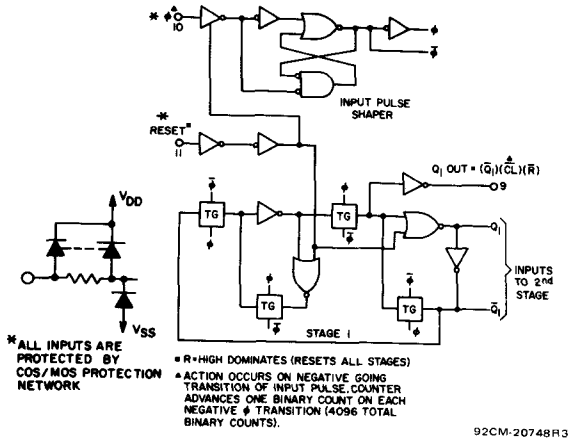

Fig.1 — Logic diagram of CD4040A input pulse shaper and 1 of 12 stages.

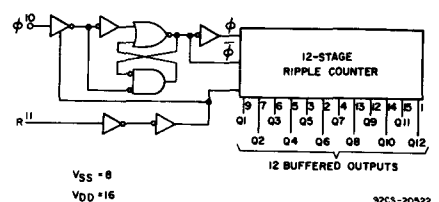

Fig.4 — Functional diagram.



# CD4040A Types

## MAXIMUM RATINGS, Absolute-Maximum Values:

STORAGE-TEMPERATURE RANGE ( $T_{STG}$ )	-65 to +150°C
OPERATING-TEMPERATURE RANGE ( $T_A$ ):	
PACKAGE TYPES D, F, K, H	-55 to +125°C
PACKAGE TYPE E	-40 to +85°C
DC SUPPLY-VOLTAGE RANGE, ( $V_{DD}$ )	
(Voltages referenced to $V_{SS}$ Terminal)	-0.5 to +15 V
POWER DISSIPATION PER PACKAGE ( $P_D$ ):	
FOR $T_A = -40$ to +60°C (PACKAGE TYPE E)	500 mW
FOR $T_A = +60$ to +85°C (PACKAGE TYPE E)	Derate Linearly at 12 mW/°C to 200 mW
FOR $T_A = -55$ to +100°C (PACKAGE TYPES D, F, K)	500 mW
FOR $T_A = +100$ to +125°C (PACKAGE TYPES D, F, K)	Derate Linearly at 12 mW/°C to 200 mW
DEVICE DISSIPATION PER OUTPUT TRANSISTOR	
FOR $T_A =$ FULL PACKAGE-TEMPERATURE RANGE (ALL PACKAGE TYPES)	100 mW
INPUT VOLTAGE RANGE, ALL INPUTS	-0.5 to $V_{DD} + 0.5$ V
LEAD TEMPERATURE (DURING SOLDERING):	
At distance 1/16 ± 1/32 inch (1.59 ± 0.79 mm) from case for 10 s max.	+265°C

## STATIC ELECTRICAL CHARACTERISTICS

Characteristic	Conditions			Limits at Indicated Temperatures (°C)								Units
				D, F, K, H Packages				E Package				
	$V_O$ (V)	$V_{IN}$ (V)	$V_{DD}$ (V)	-55	+25		+125	-40	+25		+85	
Quiescent Device Current, $I_L$ Max.	-	-	5	15	0.5	15	900	50	1	50	700	$\mu A$
	-	-	10	25	1	25	1500	100	2	100	1400	
	-	-	15	50	2.5	50	2000	500	5	500	5000	
Output Voltage: Low-Level, $V_{OL}$	-	5	5	0 Typ.; 0.05 Max.								V
	-	10	10	0 Typ.; 0.05 Max.								
High-Level, $V_{OH}$	-	0	5	4.95 Min.; 5 Typ.								V
	-	0	10	9.95 Min.; 10 Typ.								
Noise Immunity: Inputs Low, $V_{NL}$	4.2	-	5	1.5 Min.; 2.25 Typ.								V
	9	-	10	3 Min.; 4.5 Typ.								
	0.8	-	5	1.5 Min.; 2.25 Typ.								
Inputs High, $V_{NH}$	1	-	10	3 Min.; 4.5 Typ.								V
	4.5	-	5	1 Min.								
	9	-	10	1 Min.								
Noise Margin: Inputs Low, $V_{NML}$	0.5	-	5	1 Min.								V
	1	-	10	1 Min.								
	0.5	-	5	1 Min.								
Inputs High, $V_{NMH}$	1	-	10	1 Min.								V
	0.5	-	5	1 Min.								
	1	-	10	1 Min.								
Output Drive Current: N-Channel (Sink), $I_{DN}$ Min.	0.5	-	5	0.22	0.36	0.145	0.102	0.21	0.36	0.08	0.056	mA
	0.5	-	10	0.44	0.75	0.4	0.250	0.42	0.75	0.2	0.14	
P-Channel (Source), $I_{DP}$ Min.	4.5	-	5	-0.15	-0.25	-0.1	-0.07	-0.15	-0.25	-0.06	-0.04	mA
	9.5	-	10	-0.03	-0.5	-0.25	-0.175	-0.29	-0.5	-0.15	-0.1	
Input Leakage Current, $I_{IL}, I_{IH}$	Any Input											$\mu A$
	-	-	15	$\pm 10^{-5}$ Typ., $\pm 1$ Max.								

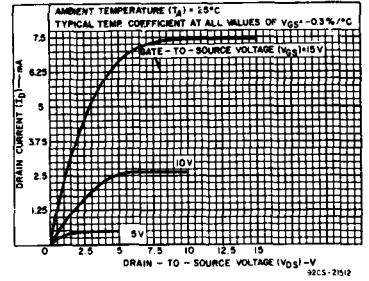

Fig. 5 - Minimum output n-channel drain characteristics.

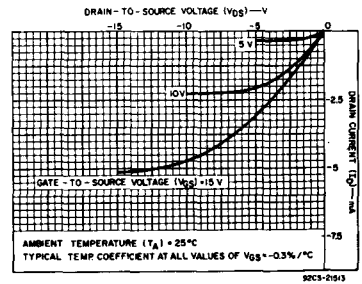

Fig. 6 - Minimum output p-channel drain characteristics.

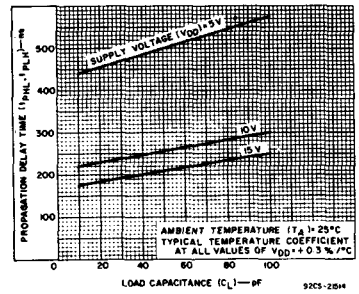

Fig. 7 - Typical propagation delay time vs. load capacitance (per stage).

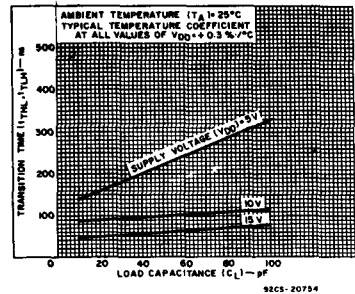

Fig. 8 - Typical transition time vs. load capacitance.

# CD4040A Types

DYNAMIC ELECTRICAL CHARACTERISTICS at  $T_A = 25^\circ\text{C}$ , Input  $t_r, t_f = 20 \text{ ns}$ ,  
 $C_L = 15 \text{ pF}$ ,  $R_L = 200 \text{ k}\Omega$

Characteristic	Test Conditions	LIMITS						Units	
		$V_{DD}$ (V)	D, F, K, H Packages			E Package			
			Min.	Typ.	Max.	Min.	Typ.		Max.
<b>Input-Pulse Operation</b>									
Propagation Delay Time, $t_{PLH}, t_{PHL}$ *	5	-	450	900	-	450	950	ns	
	10	-	225	450	-	225	475		
Transition Time, $t_{THL}, t_{TLH}$ *	5	-	150	300	-	150	350	ns	
	10	-	75	150	-	75	175		
Maximum Input-Pulse Frequency, $f_\phi$	5	1.5	2.5	-	1.5	2.5	-	MHz	
	10	4	6	-	4	6	-		
Minimum Input-Pulse Width, $t_W$	$f=100 \text{ kHz}$	5	-	200	400	-	200	500	ns
		10	-	75	110	-	75	125	
Input-Pulse Rise & Fall Time, $t_{r\phi}, t_{f\phi}$ ▲	5	-	-	15	-	-	15	$\mu\text{s}$	
	10	-	-	7.5	-	-	7.5		
Average Input Capacitance, $C_I$	Any Input	-	5	-	-	5	-	pF	
<b>Reset Operation</b>									
Propagation Delay Time, $t_{PHL}$ *	5	-	500	1000	-	500	1250	ns	
	10	-	250	500	-	250	600		
Minimum Reset Pulse Width, $t_W$	5	-	500	1000	-	500	1250	ns	
	10	-	250	500	-	250	600		

- Measured from the 50% level of the negative input pulse edge to the 50% level of either the positive or negative edge of the Q1 output (pin 9); or measured from the negative edge of Q1 through Q11 outputs to the positive or negative edge of the next higher output.

- ▲ Maximum input rise or fall time for functional operation.
- \* Measured from the positive edge of the reset pulse to the negative edge of any output (Q1 to Q12).

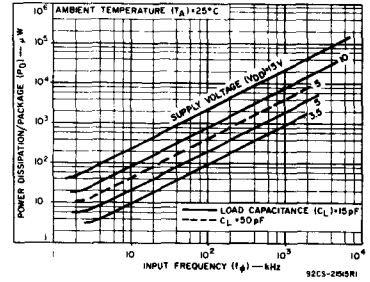

Fig. 9 - Typical dissipation characteristics.

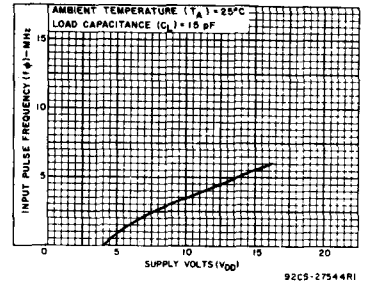

Fig. 10 - Typical input-pulse frequency vs. supply voltage.

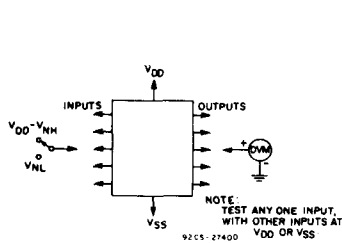

Fig. 11 - Noise-immunity test circuit.

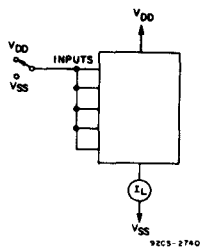

Fig. 12 - Quiescent-device-current test circuit.

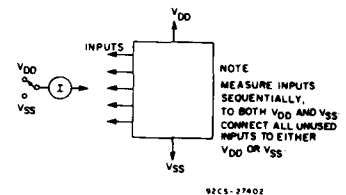

Fig. 13 - Input-leakage-current test circuit.

# CMOS Quad True/Complement Buffer

The RCA-CD4041A types are quad true/complement buffers consisting of n- and p-channel units having low channel resistance and high current (sourcing and sinking) capability. The CD4041A is intended for use as a buffer, line driver, or COS/MOS-to-TTL driver. It can be used as an ultra-low power

resistor-network driver for A/D and D/A conversion, as a transmission-line driver, and in other applications where high noise immunity and low-power dissipation are primary design requirements.

These types are supplied in 14-lead hermetic dual-in-line ceramic packages (D and F suffixes), 14-lead dual-in-line plastic package (E suffix), 14-lead ceramic flat packages (K suffix), and in chip form (H suffix).

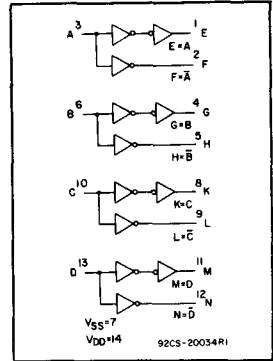

**MAXIMUM RATINGS, Absolute-Maximum Values:**

STORAGE-TEMPERATURE RANGE ( $T_{stg}$ )	-65 to +150°C
OPERATING-TEMPERATURE RANGE ( $T_A$ ):	
PACKAGE TYPES D, F, K, H	-55 to +125°C
PACKAGE TYPE E	-40 to +85°C
DC SUPPLY-VOLTAGE RANGE, ( $V_{DD}$ ):	
(Voltages referenced to $V_{SS}$ Terminal)	-0.5 to +15 V
POWER DISSIPATION PER PACKAGE ( $P_D$ ):	
FOR $T_A = -40$ to $+60^\circ\text{C}$ (PACKAGE TYPE E)	500 mW
FOR $T_A = +60$ to $+85^\circ\text{C}$ (PACKAGE TYPE E)	Derate Linearly at 12 mW/°C to 200 mW
FOR $T_A = -55$ to $+100^\circ\text{C}$ (PACKAGE TYPES D, F, K)	500 mW
FOR $T_A = +100$ to $+125^\circ\text{C}$ (PACKAGE TYPES D, F, K)	Derate Linearly at 12 mW/°C to 200 mW
DEVICE DISSIPATION PER OUTPUT TRANSISTOR	
FOR $T_A = \text{FULL PACKAGE-TEMPERATURE RANGE (ALL PACKAGE TYPES)}$	100 mW
INPUT VOLTAGE RANGE, ALL INPUTS	-0.5 to $V_{DD} + 0.5$ V
LEAD TEMPERATURE (DURING SOLDERING):	
At distance 1/16 ± 1/32 inch (1.59 ± 0.79 mm) from case for 10 s max.	+265°C

**RECOMMENDED OPERATING CONDITIONS**

For maximum reliability, nominal operating conditions should be selected so that operation is always within the following range:

CHARACTERISTIC	LIMITS		UNITS
	Min.	Max.	
Supply Voltage Range (For $T_A = \text{Full Package Temperature Range}$ )	3	12	V

**Features:**

**True Output**

- High current source and sink capability  
8 mA (typ.) @  $V_{DS} = 0.5$  V,  $V_{DD} = 10$  V  
3.2 mA (typ.) @  $V_{DS} = 0.4$  V,  $V_{DD} = 5$  V  
(two TTL loads)

**Complement Output**

- Medium current source and sink capability  
3.6 mA (typ.) @  $V_{DS} = 0.5$  V,  $V_{DD} = 10$  V  
1.6 mA (typ.) @  $V_{DS} = 0.5$  V,  $V_{DD} = 5$  V
- Quiescent current specified to 15 V
- Maximum input peakage of 1  $\mu\text{A}$  at 15 V (full package-temperature range)
- 1-V noise margin (full package temperature range)

**Applications:**

- High current source/sink driver
- CMOS-to-DTL/TTL Converter
- Display driver
- MOS clock driver
- Resistor network driver (Ladder or weighted R)
- Buffer
- Transmission line driver

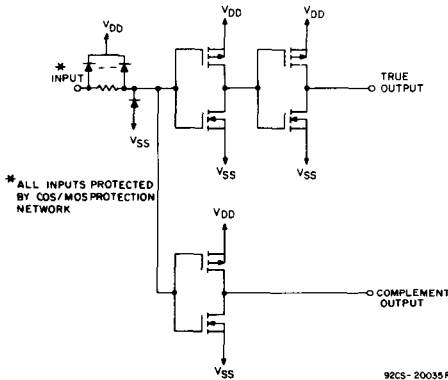

Fig. 1 - CD4041A schematic diagram.

# CD4041A Types

DYNAMIC ELECTRICAL CHARACTERISTICS at  $T_A = 25^\circ\text{C}$  and  $C_L = 15\text{ pF}$ ,  $R_L = 200\text{ k}\Omega$

CHARACTERISTIC	TEST CONDITIONS	LIMITS				UNITS	
		VDD (Volts)	D, F, K, H Packages		E Package		
			TYP.	MAX.	TYP.		MAX.
Propagation Delay Time: High-to-Low Level $t_{PHL}$	True Output	5	65	115	65	140	ns
		10	40	75	40	100	
	Comp. Output	5	55	100	55	125	ns
		10	30	45	30	65	
Low-to-High Level $t_{PLH}$	True Output	5	75	125	75	150	ns
		10	45	75	45	100	
	Comp. Output	5	45	100	45	125	ns
		10	25	50	25	60	
Transition Time: High-to-Low Level $t_{THL}$	True Output	5	20	40	20	60	ns
		10	13	25	13	40	
	Comp. Output	5	40	60	40	80	ns
Low-to-High Level $t_{TLH}$	True Output	5	20	40	20	60	ns
		10	13	25	13	40	
	Comp. Output	5	35	55	35	75	ns
Input Capacitance $C_i$	Any Input		5	-	5	-	pF

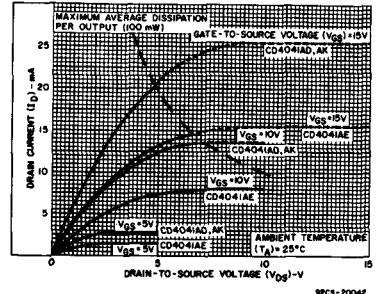

Fig. 8 - Minimum output n-channel drain characteristics - complement output.

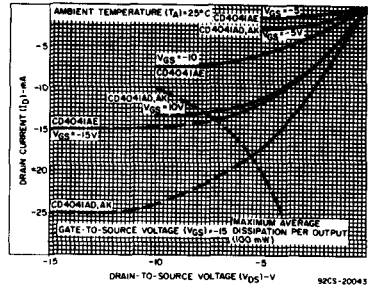

Fig. 9 - Minimum output p-channel drain characteristics - complement output.

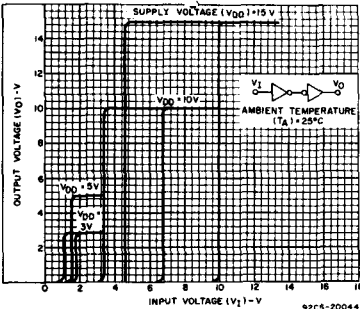

Fig. 10 - Minimum and maximum transfer characteristics - true output.

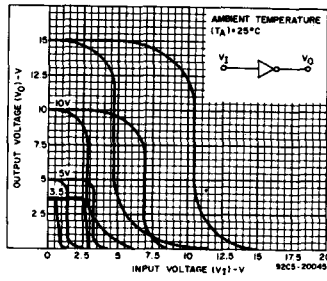

Fig. 11 - Minimum and maximum transfer characteristics - complement output.

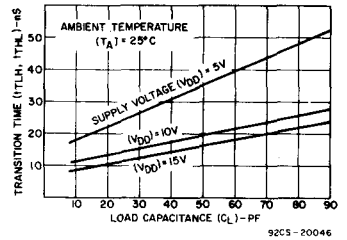

Fig. 12 - Typical transition time vs.  $C_L$  - true output.

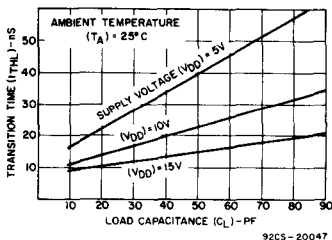

Fig. 13 - Typical high-to-low level transition time vs.  $C_L$  - complement output.

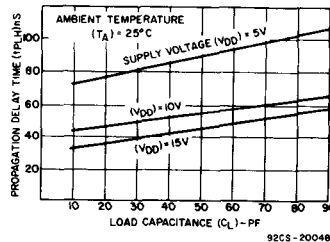

Fig. 14 - Typical low-to-high level propagation delay time vs.  $C_L$  - true output.

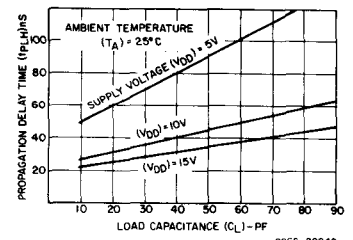

Fig. 15 - Typical low-to-high level propagation delay time vs.  $C_L$  - complement output.

# CD4041A Types

## STATIC ELECTRICAL CHARACTERISTICS

Characteristic	Conditions			Limits at Indicated Temperatures (°C)								Units
				D, F, K, H Packages				E <sub>1</sub> Package				
	V <sub>O</sub> (V)	V <sub>IN</sub> (V)	V <sub>DD</sub> (V)	-55	+25		+125	-40	+25		+85	
				Typ.	Limit			Typ.	Limit			
Quiescent Device Current, I <sub>L</sub>	-	-	5	1	0.005	1	60	10	0.01	10	140	μA
	Max.	-	15	25	0.005	2	120	20	0.02	20	280	
Output Voltage: Low-Level, V <sub>OL</sub>	-	0.5	5	0 Typ.; 0.05 Max.								V
	-	0.10	10	0 Typ.; 0.05 Max.								
High-Level, V <sub>OH</sub>	-	0.5	5	4.95 Min.; 5 Typ.								V
	-	0.10	10	9.95 Min.; 10 Typ.								
Noise Immunity: Inputs Low, V <sub>NL</sub>	3.6	-	5	1.5 Min.; 2.25 Typ.								V
	7.2	-	10	3 Min.; 4.5 Typ.								
Inputs High, V <sub>NH</sub>	1.4	-	5	1.5 Min.; 2.25 Typ.								V
	2.8	-	10	3 Min.; 4.5 Typ.								
Noise Margin: Inputs Low, V <sub>NML</sub>	4.5	-	5	1 Min.								V
	9	-	10	1 Min.								
Inputs High, V <sub>NMH</sub>	0.5	-	5	1 Min.								V
	1	-	10	1 Min.								
Output Drive Current: N-Channel (Sink), I <sub>DN</sub> Min.	0.4	True	5	2.1	3.2	1.6	1.2	1	3.2	0.8	0.7	mA
	0.5		10	6.25	10	5	3.5	3	10	2.5	2.2	
	0.5	Comp.	5	1	1.6	0.8	0.55	0.5	1.6	0.4	0.35	
	0.5		10	2.5	4	2	1.4	1.2	4	1	0.9	
P-Channel (Source), I <sub>DP</sub> Min.	4.5	True	5	-1.75	-2.8	-1.4	-1	-0.85	-2.8	-0.7	-0.6	mA
	9.5		10	-5	-8	-4	-2.8	-2.4	-8	-2	-1.8	
	4.5	Comp.	5	-0.75	-1.2	-0.6	-0.4	-0.35	-1.2	-0.3	-0.27	
	9.5		10	-2.25	-3.6	-1.8	-1.25	-1.1	-3.6	-0.9	-0.8	
Input Leakage Current, I <sub>IL</sub> , I <sub>IH</sub>	Any Input	15	±10 <sup>-5</sup> Typ.; 1 Max.								μA	

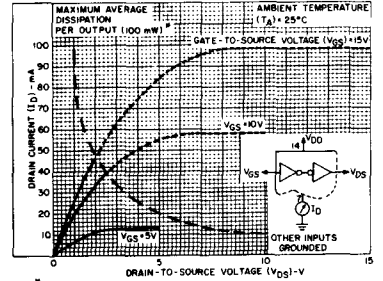

Fig. 2 - Typical output n-channel drain characteristics - true output.

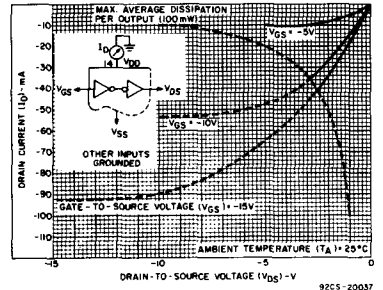

Fig. 3 - Typical output p-channel drain characteristics - true output.

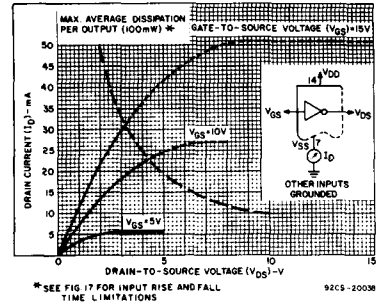

Fig. 4 - Typical output n-channel drain characteristics - complement output.

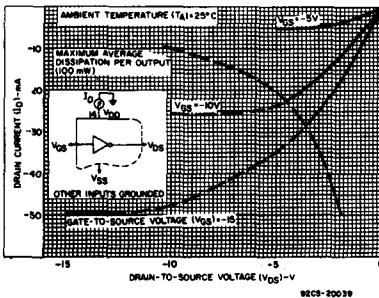

Fig. 5 - Typical output p-channel drain characteristics - complement output.

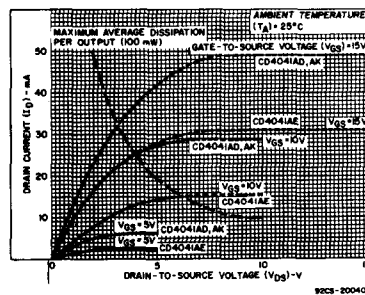

Fig. 6 - Minimum output n-channel drain characteristics - true output.

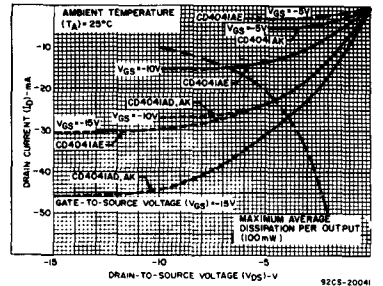

Fig. 7 - Minimum output p-channel drain characteristics - true output.

# CD401A Types

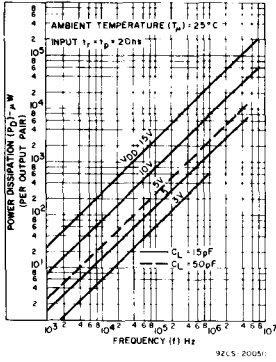

Fig.16 – Typical power dissipation vs. frequency per output pair.

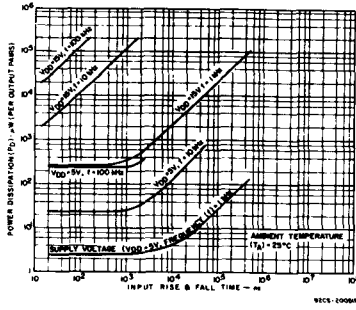

Fig.17 – Typical power dissipation vs. input rise & fall time per output pair.

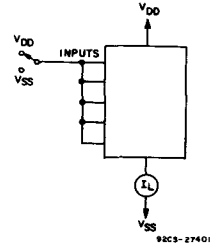

Fig.18 – Quiescent device current test circuit.

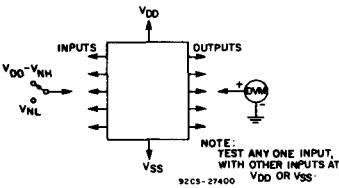

Fig.19 – Noise immunity test circuit.

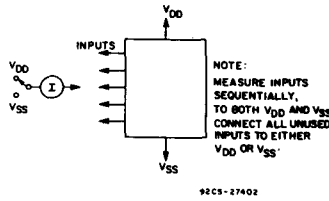

Fig.20 – Input leakage current test circuit.

### CMOS Quad Clocked "D" Latch

The RCA-CD4042A types contain four latch circuits, each strobed by a common clock. Complementary buffered outputs are available from each circuit. The impedance of the n- and p-channel output devices is balanced and all outputs are electrically identical. Information present at the data input is transferred to outputs Q and  $\bar{Q}$  during the CLOCK level which is programmed by the POLARITY input. For POLARITY = 0 the transfer occurs during the 0 CLOCK level and for POLARITY = 1 the transfer occurs during the 1 CLOCK level. The outputs follow the data input providing the CLOCK

and POLARITY levels defined above are present. When a CLOCK transition occurs (positive for POLARITY = 0 and negative for POLARITY = 1) the information present at the input during the CLOCK transition is retained at the outputs until an opposite CLOCK transition occurs.

These types are supplied in 16-lead hermetic dual-in-line ceramic packages (D and F suffixes), 16-lead dual-in-line plastic package (E suffix), 16-lead ceramic flat package (K suffix), and in chip form (H suffix).

**MAXIMUM RATINGS, Absolute-Maximum Values:**

- STORAGE-TEMPERATURE RANGE ( $T_{stg}$ ) ..... -65 to +150°C
- OPERATING-TEMPERATURE RANGE ( $T_A$ ):
  - PACKAGE TYPES D, F, K, H ..... -55 to +125°C
  - PACKAGE TYPE E ..... -40 to +85°C
- DC SUPPLY-VOLTAGE RANGE, ( $V_{DD}$ )
  - (Voltages referenced to  $V_{SS}$  Terminal) ..... -0.5 to +15 V
- POWER DISSIPATION PER PACKAGE ( $P_D$ ):
  - FOR  $T_A = -40$  to +60°C (PACKAGE TYPE E) ..... 500 mW
  - FOR  $T_A = +60$  to +85°C (PACKAGE TYPE E) ..... Derate Linearly at 12 mW/°C to 200 mW
  - FOR  $T_A = -55$  to +100°C (PACKAGE TYPES D, F, K) ..... 500 mW
  - FOR  $T_A = +100$  to +125°C (PACKAGE TYPES D, F, K) ..... Derate Linearly at 12 mW/°C to 200 mW
- DEVICE DISSIPATION PER OUTPUT TRANSISTOR
  - FOR  $T_A =$  FULL PACKAGE-TEMPERATURE RANGE (ALL PACKAGE TYPES) ..... 100 mW
- INPUT VOLTAGE RANGE, ALL INPUTS ..... -0.5 to  $V_{DD} + 0.5$  V
- LEAD TEMPERATURE (DURING SOLDERING):
  - At distance 1/16 ± 1/32 inch (1.59 ± 0.79 mm) from case for 10 s max. .... +265°C

**DYNAMIC ELECTRICAL CHARACTERISTICS at  $T_A = 25^\circ\text{C}$ , Input  $t_r, t_f = 20$  ns,  $C_L = 15$  pF,  $R_L = 200$  K $\Omega$**

CHARACTERISTIC	$V_{DD}$ (V)	LIMITS				UNITS
		D, F, K, H Packages		E Package		
		Typ.	Max.	Typ.	Max.	
Propagation Delay Time: $t_{PHL}, t_{PLH}$ Data In to Q	5	150	300	150	400	ns
	10	75	150	75	200	
Data In to $\bar{Q}$	5	250	500	250	600	ns
	10	100	200	100	250	
Clock to Q	5	300	600	300	750	ns
	10	125	250	125	300	
Clock to $\bar{Q}$	5	400	800	400	1000	ns
	10	175	350	175	400	
Transition Time: $t_{THL}, t_{TLH}$	5	100	200	100	300	ns
	10	50	100	50	150	
Minimum Clock Pulse Width, $t_W$	5	175	250	175	350	ns
	10	60	120	60	175	
Minimum Hold Time, $t_H$	5	150	300	150	350	ns
	10	60	120	60	150	
Minimum Setup Time, $t_S$	5	0	50	0	50	ns
	10	0	30	0	30	
Minimum Clock Rise or Fall Time: $t_r, t_f$	5	Not rise or fall time sensitive.				$\mu\text{s}$
10						
Input Capacitance, $C_i$ (Any Input)	-	5	-	5	-	pF

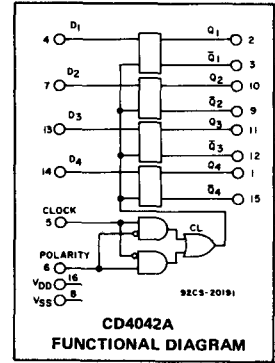

**Features:**

- Clock polarity control
- Q and  $\bar{Q}$  outputs
- Common clock
- Low power TTL compatible
- Quiescent current specified to 15 V
- Maximum input leakage of 1  $\mu\text{A}$  at 15 V (full package-temperature range)
- 1-V noise margin (full package-temperature range)

**Applications:**

- Buffer storage
- Holding register
- General digital logic

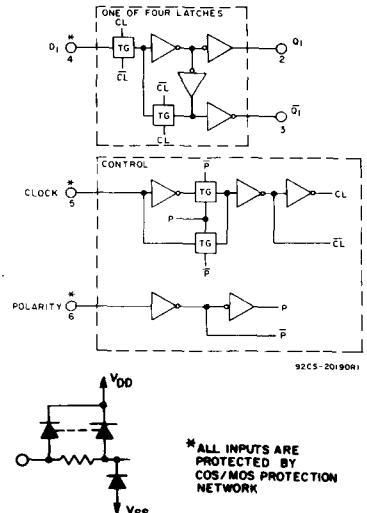

CLOCK	POLARITY	Q
0	0	D
1	0	LATCH
1	1	D
0	1	LATCH

Fig. 1 - Logic block diagram & truth table.

# CD4042A Types

RECOMMENDED OPERATING CONDITIONS at  $T_A = 25^\circ\text{C}$ , Except as Noted.  
For maximum reliability, nominal operating conditions should be selected so that operation is always within the following ranges:

CHARACTERISTIC	VDD (V)	LIMITS				UNITS
		D, F, K, H Packages		E Package		
		Min.	Max.	Min.	Max.	
Supply-Voltage Range (For $T_A = \text{Full Package Temperature Range}$ )	—	3	12	3	12	V
Clock Pulse Width, $t_W$	5 10	350 175	—	250 120	—	ns
Setup Time, $t_S$	5 10	50 30	—	50 30	—	ns
Hold Time, $t_H$	5 10	350 150	—	300 120	—	ns
Clock Rise or Fall Time: $t_r, t_f$	5 10	Not rise or fall time sensitive.				$\mu\text{s}$

## STATIC ELECTRICAL CHARACTERISTICS

Characteristic	Conditions			Limits at Indicated Temperatures ( $^\circ\text{C}$ )								Units
	VO (V)	VIN (V)	VDD (V)	D, F, K, H Packages				E Package				
				-55	+25		-40	+25		+85		
Quiescent Device Current, $I_Q$ Max.	—	—	5	1	0.005	1	60	10	0.01	10	140	$\mu\text{A}$
	—	—	10	2	0.005	2	120	20	0.02	20	280	
	—	—	15	25	0.25	25	1000	250	2.5	250	2500	
Output Voltage: Low-Level, VOL	—	0.5	5	0 Typ.; 0.05 Max.								V
	—	0.10	10	0 Typ.; 0.05 Max.								
High Level, VOH	—	0.5	5	4.95 Min.; 5 Typ.								V
	—	0.10	10	9.95 Min.; 10 Typ.								
Noise Immunity: Inputs Low, VNL	4.2	—	5	1.5 Min.; 2.25 Typ.								V
	9	—	10	3 Min.; 4.5 Typ.								
Inputs High, VNH	0.8	—	5	1.5 Min.; 2.25 Typ.								V
	1	—	10	3 Min.; 4.5 Typ.								
Noise Margin: Inputs Low, VNML	4.5	—	5	1 Min.								V
	9	—	10	1 Min.								
Inputs High, VNMH	0.5	—	5	1 Min.								V
	1	—	10	1 Min.								
Output Drive Current: n-Channel (Sink), $I_{DN}$ Min.	0.5	—	5	0.5	1	0.4	0.27	0.24	1	0.2	0.18	mA
	0.5	—	10	1.25	2	1	0.7	0.6	2	0.5	0.45	
p-Channel (Source), $I_{DP}$ Min.	4.5	—	5	-0.45	-1	-0.35	-0.25	-0.2	-1	-0.175	-0.15	mA
	9.5	—	10	-1.15	-2	-0.9	-0.6	-0.34	-2	-0.45	-0.4	
Input Leakage Current, $I_{IL}, I_{IH}$ Max.	Any Input	—	15	$\pm 10^{-5}$ Typ.; 1 Max.								$\mu\text{A}$

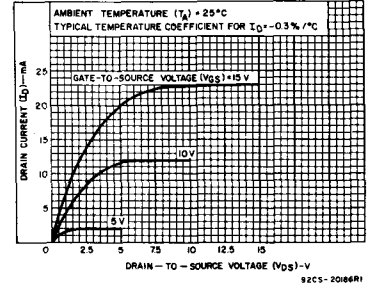

Fig. 2 — Typical output n-channel drain characteristics.

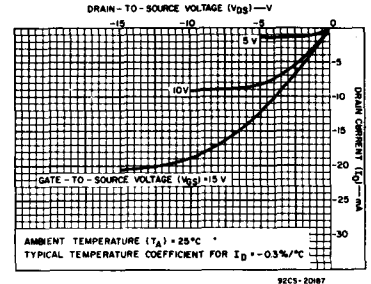

Fig. 3 — Typical output p-channel drain characteristics.

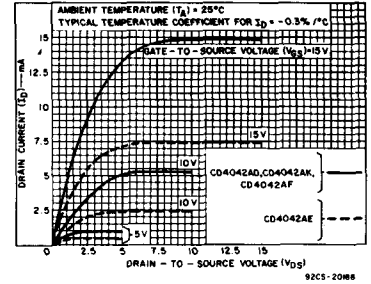

Fig. 4 — Minimum n-channel drain characteristics.

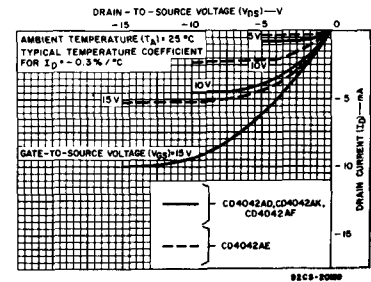
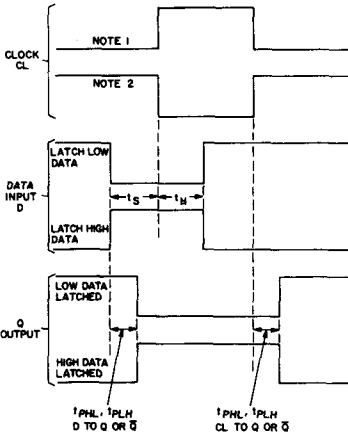

Fig. 5 — Minimum p-channel drain characteristics.



# CD4042A Types



NOTES:  
1. FOR POSITIVE CLOCK EDGE, INPUT DATA IS LATCHED WHEN POLARITY IS LOW.  
2. FOR NEGATIVE CLOCK EDGE, INPUT DATA IS LATCHED WHEN POLARITY IS HIGH.

92CS-27630

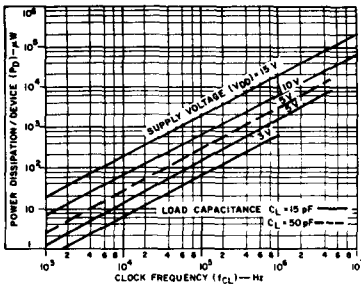

92CS-20200

Fig. 11 - Typical dissipation characteristics.

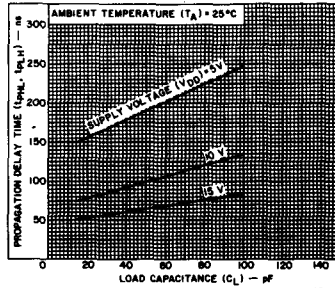

92CS-27631

Fig. 7 - Typical propagation delay time vs. load capacitance - data to Q.

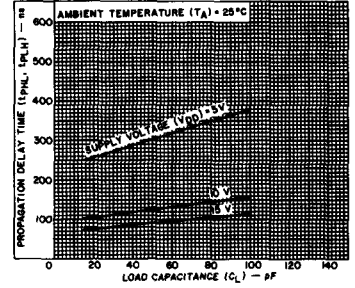

92CS-27632

Fig. 8 - Typical propagation delay time vs. load capacitance - data to  $\bar{Q}$ .

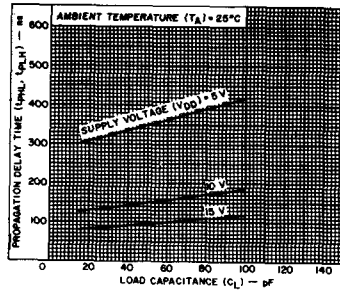

92CS-27633

Fig. 9 - Typical propagation delay time vs. load capacitance - clock to Q.

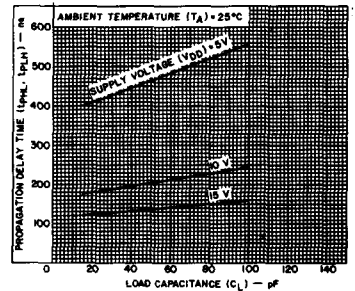

92CS-27634

Fig. 10 - Typical propagation delay time vs. load capacitance - clock to  $\bar{Q}$ .

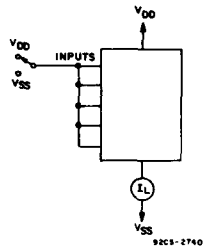

92CS-27401

Fig. 12 - Quiescent device current test circuit.

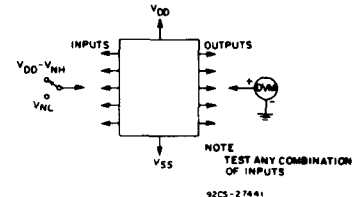

92CS-27441

Fig. 13 - Noise immunity test circuit.

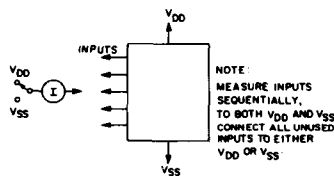

92CS-27402

Fig. 14 - Input leakage current test circuit.

# CD4043A, CD4044A Types

## CMOS Quad 3-State R/S Latches

Quad NOR R/S Latch – CD4043A  
 Quad NAND R/S Latch – CD4044A

The RCA-CD4043A types are quad cross-coupled 3-state CMOS NOR latches and the CD4044A types are quad cross-coupled 3-state CMOS NAND latches. Each latch has a separate Q output and individual SET and RESET inputs. The Q outputs are controlled by a common ENABLE input. A logic "1" or high on the ENABLE input connects the latch states to the Q outputs. A logic "0" or low on the ENABLE input disconnects the latch states from the Q outputs, resulting in an open circuit condition on the Q outputs. The open circuit feature allows common bussing of the outputs. The logic operation of the latches is summarized in the truth table shown in Fig. 1.

These types are supplied in 16-lead hermetic dual-in-line ceramic packages (D and F suffixes), 16-lead dual-in-line plastic package (E suffix), 16-lead ceramic flat packages (K suffix), and in chip form (H suffix).

### MAXIMUM RATINGS, Absolute-Maximum Values:

STORAGE-TEMPERATURE RANGE ( $T_{stg}$ )	.....	-65 to +150°C
OPERATING-TEMPERATURE RANGE ( $T_A$ ):		
PACKAGE TYPES D, F, K, H	.....	-55 to +125°C
PACKAGE TYPE E	.....	-40 to +85°C
DC SUPPLY-VOLTAGE RANGE, ( $V_{DD}$ )		
(Voltages referenced to $V_{SS}$ Terminal):	.....	-0.5 to +15 V
POWER DISSIPATION PER PACKAGE ( $P_D$ ):		
FOR $T_A = -40$ to $+60^\circ\text{C}$ (PACKAGE TYPE E)	.....	.500 mW
FOR $T_A = +60$ to $+85^\circ\text{C}$ (PACKAGE TYPE E)	.....	Derate Linearly at 12 mW/°C to 200 mW
FOR $T_A = -55$ to $+100^\circ\text{C}$ (PACKAGE TYPES D, F, K)	.....	.500 mW
FOR $T_A = +100$ to $+125^\circ\text{C}$ (PACKAGE TYPES D, F, K)	.....	Derate Linearly at 12 mW/°C to 200 mW
DEVICE DISSIPATION PER OUTPUT TRANSISTOR		
FOR $T_A = \text{FULL PACKAGE-TEMPERATURE RANGE (ALL PACKAGE TYPES)}$	.....	.100 mW
INPUT VOLTAGE RANGE, ALL INPUTS	.....	-0.5 to $V_{DD} + 0.5$ V
LEAD TEMPERATURE (DURING SOLDERING):		
At distance $1/16 \pm 1/32$ inch ( $1.59 \pm 0.79$ mm) from case for 10 s max	.....	+265°C

RECOMMENDED OPERATING CONDITIONS at  $T_A = 25^\circ\text{C}$ , Except as Noted.  
 For maximum reliability, nominal operating conditions should be selected so that operation is always within the following ranges:

CHARACTERISTIC	$V_{DD}$ (V)	LIMITS				UNITS
		D, F, K, H Packages		E Package		
		Min.	Max.	Min.	Max.	
Supply-Voltage Range (For $T_A = \text{Full Package Temperature Range}$ )	-	3	12	3	12	V
Set or Reset Pulse Width, $t_{WY}$	5 10	200 100	-	225 110	-	ns

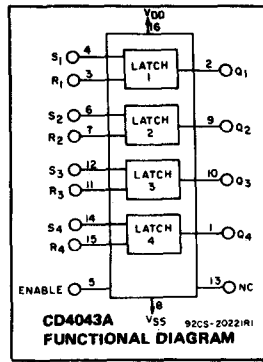

### Applications:

- Holding register in multi-register system
- Four bits of independent storage with output ENABLE
- Strobed register
- General digital logic

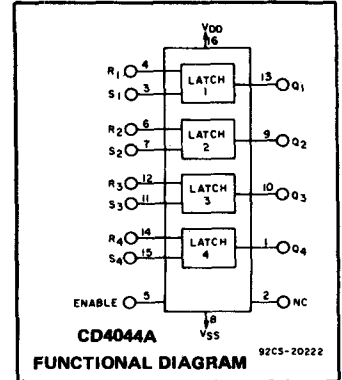

### Features:

- 3-Level outputs with common output ENABLE
- Separate SET and RESET inputs for each latch
- NOR and NAND configurations
- Quiescent current specified to 15 V
- Maximum input leakage of 1  $\mu\text{A}$  at 15 V (full package-temperature range)
- 1-V noise margin (full package-temperature range)

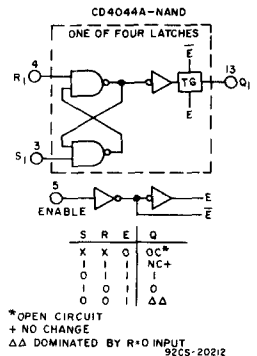
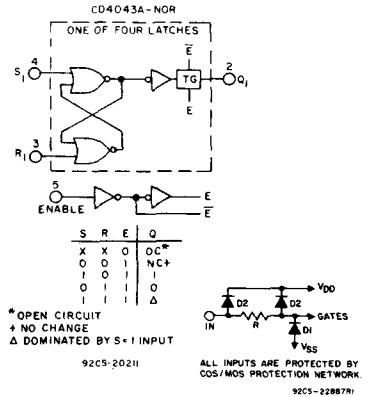

Fig. 1 - Logic diagrams and truth tables.

# CD4043A, CD4044A Types

## STATIC ELECTRICAL CHARACTERISTICS

Characteristic	Conditions			Limits at Indicated Temperatures (°C)								Units
	V <sub>O</sub> (V)	V <sub>IN</sub> (V)	V <sub>DD</sub> (V)	D, F, K, H Packages				E Package				
				-55	+25		+125	-40	+25		+85	
				Typ.	Limit	Typ.	Limit	Typ.	Limit	Typ.	Limit	
Quiescent Device Current, I <sub>L</sub> Max.	-	-	5	1	0.005	1	60	10	0.01	10	140	μA
	-	-	10	2	0.005	2	120	20	0.02	20	280	
	-	-	15	25	0.25	25	1000	250	2.5	250	2500	
Output Voltage: Low-Level, V <sub>OL</sub>	-	0.5	5	0 Typ.; 0.05 Max.								V
High Level, V <sub>OH</sub>	-	0.10	10	0 Typ.; 0.05 Max.								
High Level, V <sub>OH</sub>	-	0.5	5	4.95 Min.; 5 Typ.								
High Level, V <sub>OH</sub>	-	0.10	10	9.95 Min.; 10 Typ.								
Noise Immunity: Inputs Low, V <sub>NL</sub>	4.2	-	5	1.5 Min.; 2.25 Typ.								V
	9	-	10	3 Min.; 4.5 Typ.								
Inputs High, V <sub>NH</sub>	0.8	-	5	1.5 Min.; 2.25 Typ.;								
Inputs High, V <sub>NH</sub>	1	-	10	3 Min.; 4.5 Typ.								
Noise Margin: Inputs Low, V <sub>NML</sub>	4.5	-	5	1 Min.								V
	9	-	10	1 Min.								
Inputs High, V <sub>NMH</sub>	0.5	-	5	1 Min.								
Inputs High, V <sub>NMH</sub>	1	-	10	1 Min.								
Output Drive Current: n-Channel (Sink), I <sub>DN</sub> Min.	0.5	-	5	0.25	0.5	0.2	0.19	0.12	0.5	0.1	0.09	mA
	0.5	-	10	0.61	1	0.5	0.35	0.3	1	0.25	0.22	
p-Channel (Source), I <sub>DP</sub> Min.	4.5	-	5	-0.22	-0.5	-0.175	-0.12	-0.11	-0.5	-0.09	-0.08	
p-Channel (Source), I <sub>DP</sub> Min.	9.5	-	10	-0.5	-1	-0.4	-0.28	-0.24	-1	-0.2	-0.18	
Input Leakage Current, I <sub>IL</sub> , I <sub>IH</sub>	Any Input		15	±10 <sup>-5</sup> Typ.; ±1 Max.								μA

DYNAMIC ELECTRICAL CHARACTERISTICS at T<sub>A</sub> = 25°C; Input t<sub>r</sub>, t<sub>f</sub> = 20 ns, C<sub>L</sub> = 15 pF, R<sub>L</sub> = 200 kΩ

CHARACTERISTIC	V <sub>DD</sub> (V)	LIMITS				UNITS
		D, F, K, H Packages		E Package		
		Typ.	Max.	Typ.	Max.	
Propagation Delay Time: t <sub>PHL</sub> , t <sub>PLH</sub> SET or RESET to Q	5	175	350	175	400	ns
	10	75	175	75	200	
3-State Propagation Delay Time: ENABLE to Q t <sub>PHZ</sub> , t <sub>PZH</sub>	5	100	200	100	200	ns
	10	50	100	50	100	
t <sub>PLZ</sub> , t <sub>PZL</sub>	5	80	160	80	160	ns
	10	40	80	40	80	
Transition Time: t <sub>THL</sub> , t <sub>PLH</sub>	5	100	200	100	250	ns
	10	50	100	50	125	
Minimum SET or RESET Pulse Width, t <sub>w</sub>	5	80	200	80	225	ns
	10	40	100	40	110	
Average Input Capacitance, C <sub>i</sub> (Any Input)	-	5	-	5	-	pF

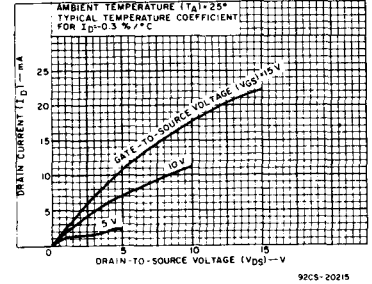

Fig. 2 - Typical output n-channel drain characteristics.

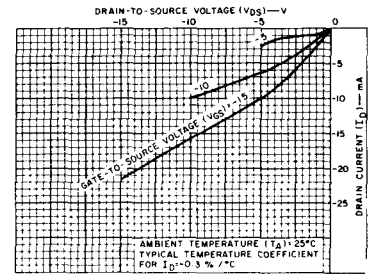

Fig. 3 - Typical output p-channel drain characteristics.

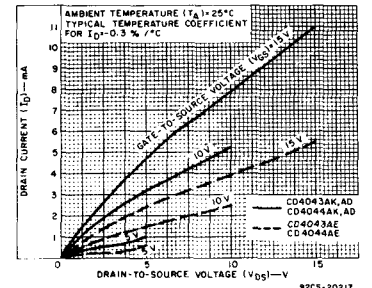

Fig. 4 - Minimum n-channel drain characteristics.

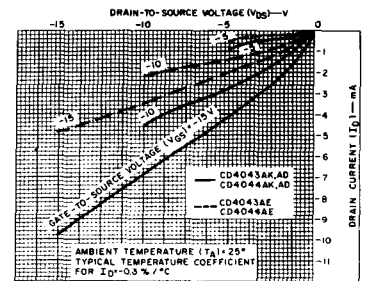

Fig. 5 - Minimum p-channel drain characteristics.



# CMOS 21-Stage Counter

The RCA-CD4045A is a timing circuit consisting of 21 counter stages, two output-shaping flip-flops, two inverter output drivers, three 5.5-V zener diodes (providing transient protection at 16.5 V), and input inverters for use in a crystal oscillator. The CD4045A configuration provides 21 flip-flop counting stages, and two flip-flops for shaping the output waveform for a 3.125% duty cycle. Push-pull operation is provided by the inverter output drivers.

The first inverter is intended for use as a crystal oscillator/amplifier. However, it may be used as a normal logic inverter if desired. A crystal oscillator circuit can be made less sensitive to voltage-supply variations by the use of source resistors. In this device, the sources of the p and n transistors have been brought out to package terminals. If external resistors are not required, the sources must be shorted to their respective substrates ( $S_p$  to  $V_{DD}$ ,  $S_n$  to  $V_{SS}$ ). See Fig. 3.

These types are supplied in 16-lead hermetic dual-in-line ceramic packages (D and F suffixes), 16-lead dual-in-line plastic package (E suffix), 16-lead ceramic flat packages (K suffix), and in chip form (H suffix).

### Applications:

- Digital equipment in which ultra-low dissipation and/or operation using a battery source are primary design requirements.
- Accurate timing from a crystal oscillator for timing applications such as wall clocks, table clocks, automobile clocks, and digital timing references in any circuit requiring accurately timed outputs at various intervals in the counting sequence.
- Driving miniature synchronous motors, stepping motors, or external bipolar transistors in push-pull fashion.

### MAXIMUM RATINGS, Absolute-Maximum Values:

STORAGE-TEMPERATURE RANGE ( $T_{stg}$ )	.....	-65 to +150°C
OPERATING-TEMPERATURE RANGE ( $T_A$ ):		
PACKAGE TYPES D, F, K, H	.....	-55 to +125°C
PACKAGE TYPE E	.....	-40 to +85°C
DC SUPPLY-VOLTAGE RANGE, ( $V_{DD}$ )		
(Voltages referenced to $V_{SS}$ Terminal):	.....	-0.5 to +15 V
POWER DISSIPATION PER PACKAGE ( $P_D$ ):		
FOR $T_A = -40$ to $+60$ °C (PACKAGE TYPE E)	.....	.500 mW
FOR $T_A = +60$ to $+85$ °C (PACKAGE TYPE E)	.....	Derate Linearly at 12 mW/°C to 200 mW
FOR $T_A = -55$ to $+100$ °C (PACKAGE TYPES D, F, K)	.....	.500 mW
FOR $T_A = +100$ to $+125$ °C (PACKAGE TYPES D, F, K)	.....	Derate Linearly at 12 mW/°C to 200 mW
DEVICE DISSIPATION PER OUTPUT TRANSISTOR		
FOR $T_A =$ FULL PACKAGE-TEMPERATURE RANGE (ALL PACKAGE TYPES)	.....	.100 mW
INPUT VOLTAGE RANGE, ALL INPUTS	.....	-0.5 to $V_{DD} + 0.5$ V
LEAD TEMPERATURE (DURING SOLDERING):		
At distance 1/16 ± 1/32 inch (1.59 ± 0.79 mm) from case for 10 s max.	.....	+265°C

### RECOMMENDED OPERATING CONDITIONS at $T_A = 25$ °C, Except as Noted.

For maximum reliability, nominal operating conditions should be selected so that operation is always within the following ranges:

CHARACTERISTIC	$V_{DD}$ (V)	LIMITS				UNITS
		D, F, K, H Packages		E Package		
		Min.	Max.	Min.	Max.	
Supply-Voltage Range (For $T_A =$ Full Package-Temperature Range)		3	12	3	12	V
Input-Pulse Width, $t_W$	5 10	115 60	- -	140 75	- -	ns
Input-Pulse Frequency, $f_\phi$	5 10	dc dc	4.4 8.5	dc dc	3.5 6.5	MHz
Input-Pulse Rise or Fall Time, $t_r\phi$ , $t_f\phi$	5 10	- -	15 10	- -	15 10	$\mu$ s

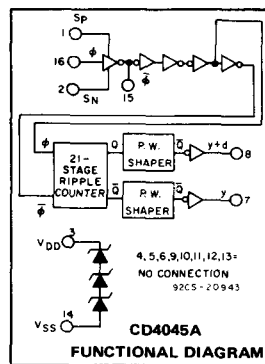

### Features:

- Microwatt quiescent dissipation .....
  - 2.5  $\mu$ W (typ.) @  $V_{DD} = 5$  V;
  - 10  $\mu$ W (typ.) @  $V_{DD} = 10$  V
- Very low operating dissipation .....
  - 1 mW (typ.); @  $V_{DD} = 5$  V,  $f_\phi = 1$  MHz
- Output drivers with sink or source capability .....
  - 7 mA (typ.) @  $V_O = 0.5$  V,  $V_{DD} = 5$  V (sink)
  - 5 mA (typ.) @  $V_O = 4.5$  V,  $V_{DD} = 5$  V (source)
- Medium speed (typ.) .....
  - $f_\phi = 5$  MHz @  $V_{DD} = 5$  V
  - $f_\phi = 10$  MHz @  $V_{DD} = 10$  V
- 16.5 V zener diode transient protection on chip for automotive use
- Quiescent current specified to 15 V
- Maximum input leakage current of 1  $\mu$ A at 15 V (full package-temperature range)
- 1-V noise margin (full package-temperature range)

NOTE 1: To minimize power dissipation in the zener diodes, and to ensure device dissipation less than 200 mW, a 150  $\Omega$  current-limiting resistor must be placed in series with the power supply for  $V_{DD} > 13$  V.

NOTE 2: Observe power-supply terminal connections.  $V_{DD}$  is terminal No. 3 and  $V_{SS}$  is terminal No. 14 (not 16 and 8 respectively, as in all other CD4000A Series 16-lead devices).

# CD4045A Types

DYNAMIC ELECTRICAL CHARACTERISTICS at  $T_A = 25^\circ\text{C}$ , Input  $t_r, t_f = 20 \text{ ns}$ ,  
 $C_L = 15 \text{ pF}$ ,  $R_L = 200 \text{ k}\Omega$

CHARACTERISTIC	TEST CONDITIONS	LIMITS						UNITS
		D, F, K, H Packages			E Package			
		VDD (V)	Min.	Typ.	Max.	Min.	Typ.	
Propagation Delay Time: $\phi$ to y or y+d out tPLH, tPHL	5	—	2.2	4.4	—	2.2	5.5	$\mu\text{s}$
	10	—	1.2	2.4	—	1.2	3.3	
Transition Time: tTHL, tTLH	5	—	450	800	—	450	900	ns
	10	—	375	650	—	375	750	
Maximum Input-Pulse Frequency, $f_{m\phi}$	5	4.4	5	—	3.5	5	—	MHz
	10	8.5	10	—	6.5	10	—	
Minimum Input-Pulse Width, $t_W$	5	—	100	115	—	100	140	ns
	10	—	50	60	—	50	75	
Input-Pulse Rise & Fall Time; $t_r\phi$ , $t_f\phi$	5	—	—	15	—	—	15	$\mu\text{s}$
	10	—	—	10	—	—	10	
Average Input Capacitance, $C_I$	Any Input	—	5	—	—	5	—	pF

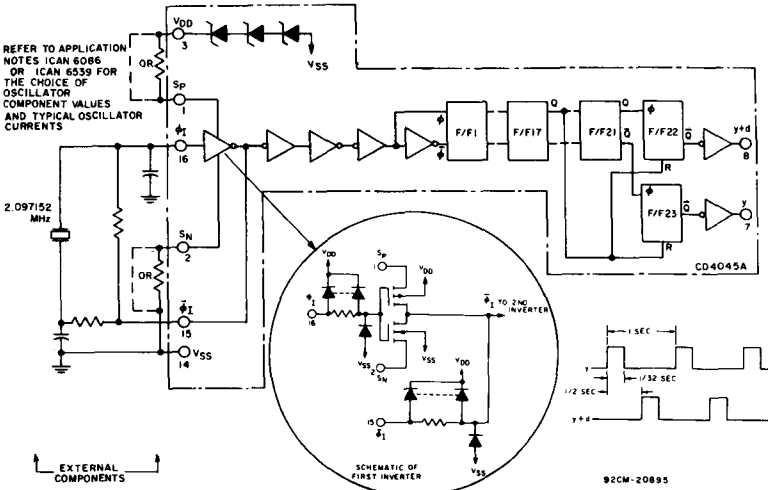

Fig. 3 — CD4045A and outboard components in a typical 21-stage counter application.

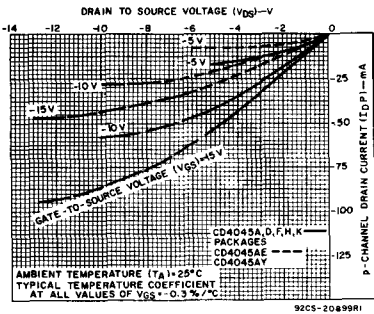

Fig. 5 — Minimum output p-channel drain characteristics.

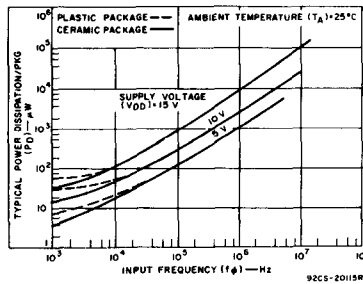

Fig. 6 — Typical dissipation vs input frequency (21 counting stages).

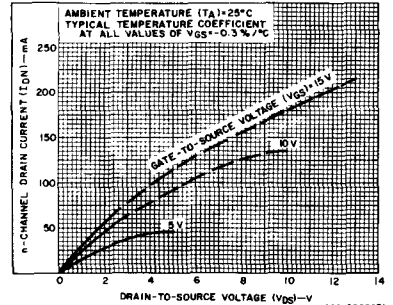

Fig. 1 — Typical output n-channel drain characteristics.

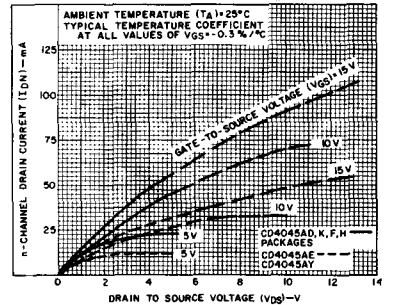

Fig. 2 — Minimum output n-channel drain characteristics.

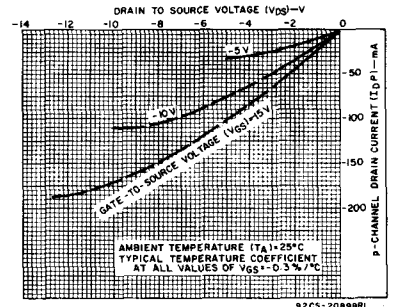

Fig. 4 — Typical output p-channel drain characteristics.

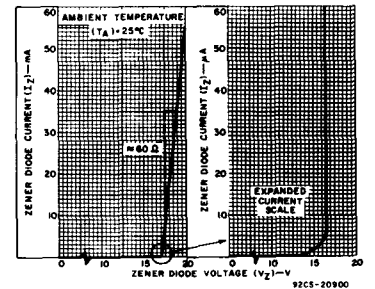

Fig. 7 — Typical zener diode characteristics.

# CD4045A Types

## STATIC ELECTRICAL CHARACTERISTICS

Characteristic	Conditions			Limits at Indicated Temperatures (°C)								Units
				D, F, K, H Packages				E Package				
	V <sub>O</sub> (V)	V <sub>IN</sub> (V)	V <sub>DD</sub> (V)	-55	+25 Typ. Limit	+125	-40	+25 Typ. Limit	+85			
Quiescent Device Current I <sub>L</sub> Max.	-	-	5	15	0.5	15	900	50	1	50	700	μA
	-	-	10	25	1	25	1500	100	2	100	1400	
	-	-	15	50	1	50	2000	500	5	500	5000	
Output Voltage: Low-Level, V <sub>OL</sub> High Level V <sub>OH</sub>	-	5	5	0 Typ.; 0.05 Max.								V
	-	10	10	0 Typ.; 0.05 Max.								
	-	0	5	4.95 Min.; 5 Typ.								
	-	0	10	9.95 Min.; 10 Typ.								
Noise Immunity: Inputs Low, V <sub>NL</sub> Inputs High V <sub>NH</sub>	4.2	-	5	1.5 Min.; 2.25 Typ.								V
	9	-	10	3 Min.; 4.5 Typ.								
	0.8	-	5	1.5 Min.; 2.25 Typ.								
Noise Margin: Inputs Low, V <sub>NML</sub> Inputs High, V <sub>NMH</sub>	4.5	-	5	1 Min.								V
	9	-	10	1 Min.								
	0.5	-	5	1 Min.								
Output Drive Current: n-Channel (Sink) I <sub>DN</sub> Min. p-Channel (Source): I <sub>DP</sub> Min.	0.5	-	5	4.4	7	3.5	2.5	2.2	7	1.8	1.3	mA
	0.5	-	10	6.9	11	5.5	3.9	3.5	11	2.8	2	
	4.5	-	5	-3.1	-5	-2.5	-1.8	-1.6	-5	-1.3	-0.9	
Input Leakage Current, I <sub>IL</sub> , I <sub>IH</sub>	Any Input			±10 <sup>-5</sup> Typ., ±1 Max.								μA
	-	-	15									
Zener Breakdown Voltage, V (BR)Z	1-100 μA	Min.	13.3	-	13.5	13.7	13.3	-	13.5	13.6		V
		Typ.	-	16.5	-	-	-	16.5	-	-	-	
		Max.	17.8	-	18	18.2	17.8	-	18	18.1		

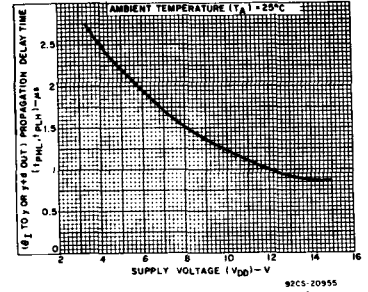

Fig. 8 - Typical propagation delay ( $\phi_1$  to  $y$  or  $y+d$  out) vs  $V_{DD}$ .

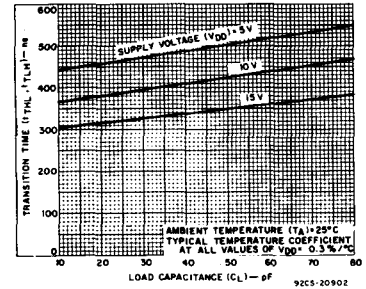

Fig. 9 - Typical transition time vs  $C_L$ .

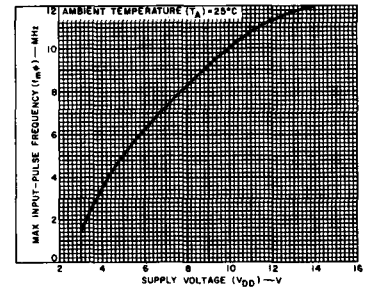

Fig. 10 - Typical maximum input-pulse frequency.

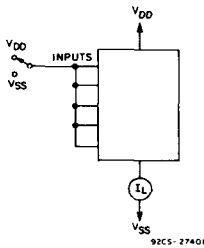

Fig. 11 - Quiescent-device-current test circuit.

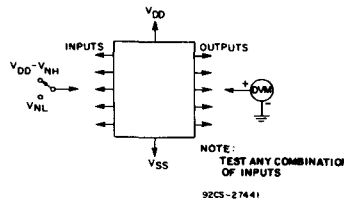

Fig. 12 - Noise-immunity test circuit.

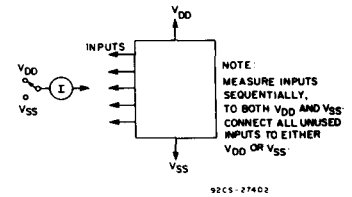

Fig. 13 - Input-leakage-current test circuit.

## CD4046A Types

# CMOS Micropower Phase-Locked Loop

The RCA-CD4046A CMOS Micropower Phase-Locked Loop (PLL) consists of a low-power, linear voltage-controlled oscillator (VCO) and two different phase comparators having a common signal-input amplifier and a common comparator input. A 5.2-V zener diode is provided for supply regulation if necessary.

These types are supplied in 16-lead hermetic dual-in-line ceramic packages (D and F suffixes), 16-lead dual-in-line plastic package (E suffix), 16-lead ceramic flat packages (K suffix), and in chip form (H suffix).

### VCO Section

The VCO requires one external capacitor C1 and one or two external resistors (R1 or R1 and R2). Resistor R1 and capacitor C1 determine the frequency range of the VCO and resistor R2 enables the VCO to have a frequency offset if required. The high input impedance ( $10^{12}\Omega$ ) of the VCO simplifies the design of low-pass filters by permitting the designer a wide choice of resistor-to-capacitor ratios. In order not to load the low-pass filter, a source-follower output of the VCO input voltage is provided at terminal 10 (DEMOMULATED OUTPUT). If this terminal is used, a load resistor (RS) of 10 k $\Omega$  or more should be connected from this terminal to VSS. If unused this terminal should be left open. The VCO can be connected either directly or through frequency dividers to the comparator input of the phase comparators. A full CMOS logic swing is available at the output of the VCO and allows direct coupling to CMOS frequency dividers such as the RCA-CD4024, CD4018, CD4020, CD4022, CD4029, and CD4059. One or more CD4018 (Presetable Divide-by-N Counter) or CD4029 (Presetable Up/Down Counter), or CD4059A (Programmable Divide-by-"N" Counter), together with the CD4046A (Phase-Locked Loop) can be used to build a micropower low-frequency synthesizer. A logic 0 on the INHIBIT input "enables" the VCO and the source follower, while a logic 1 "turns off" both to minimize stand-by power consumption.

### Phase Comparators

The phase-comparator signal input (terminal 14) can be direct-coupled provided the signal swing is within CMOS logic levels [logic "0"  $\leq 30\%$  ( $V_{DD}-V_{SS}$ ), logic "1"  $\geq 70\%$  ( $V_{DD}-V_{SS}$ )]. For smaller swings the signal must be capacitively coupled to the self-biasing amplifier at the signal input.

Phase comparator I is an exclusive-OR network; it operates analogously to an over-driven balanced mixer. To maximize the lock range, the signal- and comparator-input frequencies must have a 50% duty cycle. With no signal or noise on the signal input, this phase comparator has an average output voltage equal to  $V_{DD}/2$ . The low-pass filter connected to the output of phase comparator I supplies the averaged voltage to the VCO input, and causes the VCO to oscillate at the center frequency ( $f_0$ ).

The frequency range of input signals on which the PLL will lock if it was initially

### Features:

- Very low power consumption: 70  $\mu$ W (typ.) at VCO  $f_0 = 10$  kHz,  $V_{DD} = 5$  V
- Operating frequency range up to 1.2 MHz (typ.) at  $V_{DD} = 10$  V
- Wide supply-voltage range:  $V_{DD} - V_{SS} = 5$  to 15 V
- Low frequency drift: 0.06%/°C (typ.) at  $V_{DD} = 10$  V

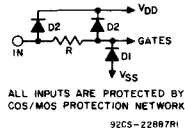
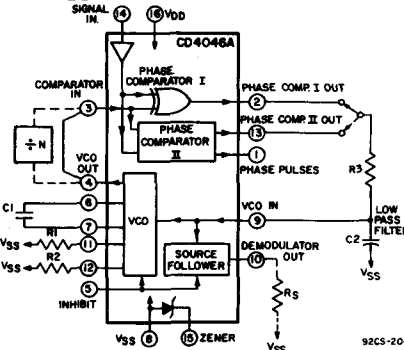

Fig. 1 - COS/MOS phase-locked loop block diagram.

### MAXIMUM RATINGS, Absolute-Maximum Values:

STORAGE-TEMPERATURE RANGE ( $T_{stg}$ )	-65 to +150°C
OPERATING-TEMPERATURE RANGE ( $T_A$ ):	
PACKAGE TYPES D, F, K, H	-55 to +125°C
PACKAGE TYPE E	-40 to +85°C
DC SUPPLY-VOLTAGE RANGE, ( $V_{DD}$ )	
(Voltages referenced to $V_{SS}$ Terminal)	-0.5 to +15 V
POWER DISSIPATION PER PACKAGE ( $P_D$ ):	
FOR $T_A = -40$ to +60°C (PACKAGE TYPE E)	500 mW
FOR $T_A = +60$ to +85°C (PACKAGE TYPE E)	Derate Linearly at 12 mW/°C to 200 mW
FOR $T_A = -55$ to +100°C (PACKAGE TYPES D, F, K)	500 mW
FOR $T_A = +100$ to +125°C (PACKAGE TYPES D, F, K)	Derate Linearly at 12 mW/°C to 200 mW
DEVICE DISSIPATION PER OUTPUT TRANSISTOR	
FOR $T_A =$ FULL PACKAGE-TEMPERATURE RANGE (ALL PACKAGE TYPES)	100 mW
INPUT VOLTAGE RANGE, ALL INPUTS	-0.5 to $V_{DD} + 0.5$ V
LEAD TEMPERATURE (DURING SOLDERING):	
At distance 1/16 $\pm$ 1/32 inch (1.59 $\pm$ 0.79 mm) from case for 10 s max.	+265°C

out of lock is defined as the frequency capture range ( $2f_c$ ).

The frequency range of input signals on which the loop will stay locked if it was initially in lock is defined as the frequency lock range ( $2f_L$ ). The capture range is  $\leq$  the lock range.

With phase comparator I the range of frequencies over which the PLL can acquire lock (capture range) is dependent on the low-pass-filter characteristics, and can be made as large as the lock range. Phase-com-

- Choice of two phase comparators:
  1. Exclusive-OR network
  2. Edge-controlled memory network with phase-pulse output for lock indication
- High VCO linearity: 1% (typ.)
- VCO inhibit control for ON-OFF keying and ultra-low standby power consumption
- Source-follower output of VCO control input (Demod. output)
- Zener diode to assist supply regulation
- Quiescent current specified to 15  $\mu$ A
- Maximum input leakage current of 1  $\mu$ A at 15 V (full package-temperature range)

### Applications:

- FM demodulator and modulator
- Frequency synthesis and multiplication
- Frequency discriminator
- Data synchronization
- Voltage-to-frequency conversion
- Tone decoding
- FSK - Modems
- Signal conditioning
- (See ICAN-6101) "RCA CMOS Phase-Locked Loop - A Versatile Building Block for Micropower Digital and Analog Applications"

parator I enables a PLL system to remain in lock in spite of high amounts of noise in the input signal.

One characteristic of this type of phase comparator is that it may lock onto input frequencies that are close to harmonics of the VCO center-frequency. A second characteristic is that the phase angle between the signal and the comparator input varies between 0° and 180°, and is 90° at the center frequency. Fig. 2 shows the typical, triangular, phase-to-output response characteristic



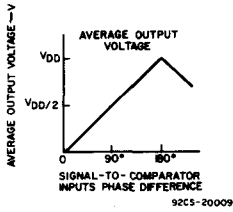

Fig.2 - Phase-comparator I characteristics at low-pass filter output.

of phase-comparator I. Typical waveforms for a CMOS phase-locked-loop employing phase comparator I in locked condition of  $f_0$  is shown in Fig. 3.

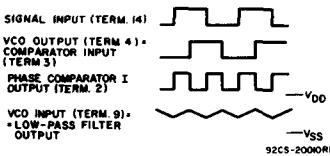

Fig.3 - Typical waveforms for COS/MOS phase-locked loop employing phase comparator I in locked condition of  $f_0$ .

Phase-comparator II is an edge-controlled digital memory network. It consists of four flip-flop stages, control gating, and a three-state output circuit comprising p- and n-type drivers having a common output node. When the p-MOS or n-MOS drivers are ON they pull the output up to  $V_{DD}$  or down to  $V_{SS}$ , respectively. This type of phase comparator acts only on the positive edges of the signal and comparator inputs. The duty cycles of the signal and comparator inputs are not important since positive transitions control the PLL system utilizing this type of comparator. If the signal-input frequency is higher than the comparator-input frequency, the p-type output driver is maintained ON most of the time, and both the n and p drivers OFF (3 state) the remainder of the time. If the signal-input frequency is lower than the comparator-input frequency, the n-type output driver is maintained ON most of the time, and both the n and p drivers OFF (3 state) the remainder of the time. If the signal- and comparator-input frequencies are the same, but the signal input lags the comparator input in phase, the n-type output driver is maintained ON for a time corresponding to the phase difference. If the signal- and comparator-input frequencies are the same, but the comparator input lags the signal in phase, the p-type output driver is maintained ON for a time corresponding to the phase difference. Subsequently, the capacitor voltage of the low-pass filter connected to this phase comparator is adjusted until the signal and comparator inputs are equal in both phase and frequency. At this stable point both p- and n-type output drivers remain OFF and thus the phase comparator output becomes an open circuit and holds the voltage on the capacitor of the low-pass filter constant.

RECOMMENDED OPERATING CONDITIONS

For maximum reliability, nominal operating conditions should be selected so that operation is always within the following range:

CHARACTERISTIC	LIMITS		UNITS
	Min.	Max.	
Supply Voltage Range (For $T_A$ = Full Package Temperature Range)	3	12	V

ELECTRICAL CHARACTERISTICS at  $T_A = 25^\circ\text{C}$

Characteristic	Test Conditions	Limits			Units		
		All Package Types					
		Min.	Typ.	Max.			
<b>Phase Comparator Section</b>							
Operating Supply Voltage, $V_{DD}-V_{SS}$	VCO Operation	-	5	-	15	V	
	Comparators only	-	3	-	15		
Total Quiescent Device Current, $I_{L}$ : Term. 14 Open	Term. 15 open Term. 5 at $V_{DD}$ Terms. 3 & 9 at $V_{SS}$	5	-	25	-	$\mu\text{A}$	
		10	-	200	-		
		5	-	5	15		
		10	-	25	60		
Term. 14 at $V_{SS}$ or $V_{DD}$		15	-	50	500		
Term. 14 (SIGNAL IN) Input Impedance, $Z_{14}$		5	1	2	-	$\text{M}\Omega$	
		10	0.2	0.4	-		
		15	-	0.2	-		
AC-Coupled Signal Input Voltage Sensitivity* (peak-to-peak)	See Fig.7	5	-	200	400	mV	
		10	-	400	800		
		15	-	700	-		
DC-Coupled Signal Input and Comparator Input Voltage Sensitivity Low Level		5	1.5	2.25	-	V	
		10	3	4.5	-		
		15	4.5	6.75	-		
High Level	$V_O$ Volts	5	-	2.75	3.5		
		10	-	5.5	7		
		15	-	8.25	-		
Output Drive Current: n-Channel (Sink), $I_{DN}$	Phase Comparator I & II Term. 2 & 13	0.5	5	0.43	0.86	mA	
		0.5	10	1.3	2.5		
		0.5	5	0.23	0.47		
	Phase Pulses	0.5	10	0.7	1.4		
		4.5	5	-0.3	-0.6		
		9.5	10	-0.9	-1.8		
p-Channel (Source), $I_{DP}$	Phase Pulses	4.5	5	-0.08	-0.16		
		9.5	10	-0.25	-0.5		
Input Leakage Current, $I_{L}, I_{IH}$ Max.	Any Input		15	-	$\pm 10^{-5}$	$\pm 1$	$\mu\text{A}$

\* For sine wave, the frequency must be greater than 1 kHz for Phase Comparator II.

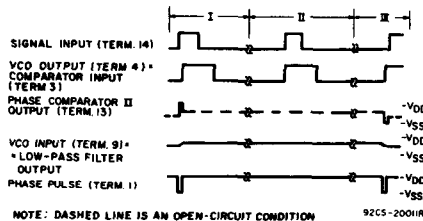

Fig.4 - Typical waveforms for CMOS phase-locked loop employing phase comparator II in locked condition.

# CD4046A Types

## ELECTRICAL CHARACTERISTICS at $T_A = 25^\circ\text{C}$

Characteristic	Test Conditions		Limits			Units		
			All Package Types					
			VO Volts	VDD Volts	Min.		Typ.	Max.
<b>VCO Section</b>								
Operating Supply Voltage $V_{DD}-V_{SS}$	As fixed oscillator only			3	—	15	V	
	Phase-lock-loop operation			5	—	15		
Operating Power Dissipation, $P_D$	$f_0 = 10 \text{ kHz}$ $R_2 = \infty$ $V_{COIN} = \frac{V_{DD}}{2}$	$R_1 = 1 \text{ M}\Omega$	5	—	70	—	$\mu\text{W}$	
			10	—	600	—		
			15	—	2400	—		
Maximum Operating Frequency, $f_{max}$	$R_1 = 10 \text{ k}\Omega$ $R_2 = \infty$ $V_{COIN} = V_{DD}$	$C_1 = 100 \text{ pF}$	5	0.25	0.5	—	MHz	
			10	0.6	1.2	—		
		$C_1 = 50 \text{ pF}$	15	—	1.5	—		
Center Frequency ( $f_0$ ) and Frequency Range, $f_{max}-f_{min}$	Programmable with external components R1, R2, and C1 <i>See Design Information</i>							
Linearity	$V_{COIN} = 2.5 \text{ V} \pm 0.3 \text{ V}, R_1 > 10 \text{ k}\Omega$		5	—	1	—	%	
	$= 5 \text{ V} \pm 2.5 \text{ V}, R_1 > 400 \text{ k}\Omega$		10	—	1	—		
	$= 7.5 \text{ V} \pm 5 \text{ V}, R_1 = 1 \text{ M}\Omega$		15	—	1	—		
Temperature-Frequency Stability* No Frequency Offset $f_{MIN} = 0$	$\%/\text{C} \propto \frac{1}{f \cdot V_{DD}}$ $R_2 = \infty$		5	—	0.12–0.24	—	$\%/\text{C}$	
			10	—	0.04–0.08	—		
			15	—	0.015–0.03	—		
Frequency Offset $f_{MIN} \neq 0$	$\%/\text{C} \propto \frac{1}{f \cdot V_{DD}}$		5	—	0.06–0.12	—	$\%/\text{C}$	
			10	—	0.05–0.1	—		
			15	—	0.03–0.06	—		
Input Resistance of $V_{COIN}$ (Term 9), $R_I$			5,10,15	—	10 <sup>12</sup>	—	$\Omega$	
VCO Output Voltage (Term 4) Low Level, $V_{OL}$	Driving CMOS-Type Load (e.g. Term 3 Phase Comparator Input)		5,10,15	—	—	0.01	V	
High Level, $V_{OH}$			5	4.99	—	—		—
			10	9.99	—	—		—
VCO Output Duty Cycle			5,10,15	—	50	—	%	
VCO Output Transition Times, $t_{THL}, t_{TLH}$			VO Volts	5	—	75	150	ns
				10	—	50	100	
				15	—	40	—	
VCO Output Drive Current: n-Channel (Sink), $I_{DN}$			0.5	5	0.43	0.86	—	mA
			0.5	10	1.3	2.6	—	
p-Channel (Source), $I_{DP}$			4.5	5	-0.3	-0.6	—	mA
			9.5	10	-0.9	-1.8	—	
Source-Follower Output (Demodulated Output): Offset Voltage ( $V_{COIN}-V_{DEM}$ )	$R_S > 10 \text{ k}\Omega$		5,10	—	1.5	2.2	V	
Linearity	$R_S > 50 \text{ k}\Omega$	$V_{COIN} = 2.5 \pm 0.3 \text{ V}$	5	—	0.1	—	%	
		$= 5 \pm 2.5 \text{ V}$	10	—	0.6	—		
		$= 7.5 \pm 5 \text{ V}$	15	—	0.8	—		
Zener Diode Voltage ( $V_Z$ )	$I_Z = 50 \mu\text{A}$			4.5	5.2	6.1	V	
Zener Dynamic Resistance, $R_Z$	$I_Z = 1 \text{ mA}$			—	100	—	$\Omega$	

\* Positive coefficient.

Moreover the signal at the "phase pulses" output is a high level which can be used for indicating a locked condition. Thus, for phase comparator II, no phase difference exists between signal and comparator input over the full VCO frequency range. Moreover, the power dissipation due to the low-pass filter is reduced when this type of phase comparator is used because both the p- and n-type output drivers are OFF for most of the signal input cycle. It should be noted that the PLL lock range for this type of phase comparator is equal to the capture range, independent of the low-pass filter. With no signal present at the signal input, the VCO is adjusted to its lowest frequency for phase comparator II. Fig. 4 shows typical waveforms for a CMOS PLL employing phase comparator II in a locked condition.

# CD4046A Types

## DESIGN INFORMATION

This information is a guide for approximating the values of external components for the CD4046A in a Phase-Locked-Loop system. The selected external components must be within the following ranges:

$$10\text{ k}\Omega \leq R_1, R_2, R_S \leq 1\text{ M}\Omega$$

$$C_1 \geq 100\text{ pF at } V_{DD} \geq 5\text{ V}$$

$$C_1 \geq 50\text{ pF at } V_{DD} \geq 10\text{ V}$$

In addition to the given design information refer to Fig.5 for R1, R2, and C1 component selections.

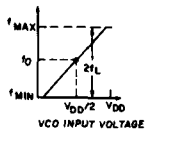
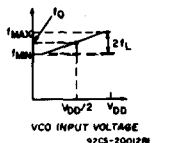
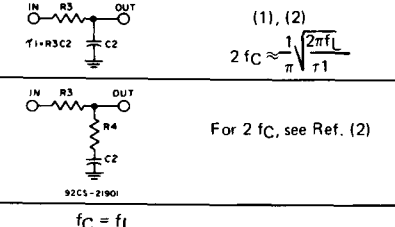
Characteristics	Phase Comparator Used	Design Information	
VCO Frequency	1	VCO WITHOUT OFFSET $R_2 = \infty$	VCO WITH OFFSET
			
For No Signal Input	1	Same as for No.1	
	2	VCO will adjust to center frequency, $f_0$	
Frequency Lock Range, $2f_L$	1	$2f_L = \text{full VCO frequency range}$ $2f_L = f_{\text{max}} - f_{\text{min}}$	
	2	Same as for No.1	
Frequency Capture Range, $2f_C$	1		
	2	For $2f_C$ , see Ref. (2)	
Loop Filter Component Selection	1	$f_C = f_L$	
	2	$f_C = f_L$	
Phase Angle Between Signal and Comparator	1	$90^\circ$ at center frequency ( $f_0$ ) approximating $0^\circ$ and $180^\circ$ at ends of lock range ( $2f_L$ )	
	2	Always $0^\circ$ in lock	

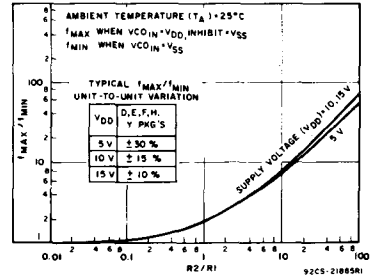

Fig.5(c) - Typical  $f_{\text{max}}/f_{\text{min}}$  vs  $R_2/R_1$ .

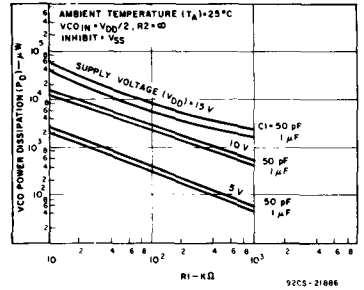

Fig.6(a) - Typical VCO power dissipation at center frequency vs  $R_1$ .

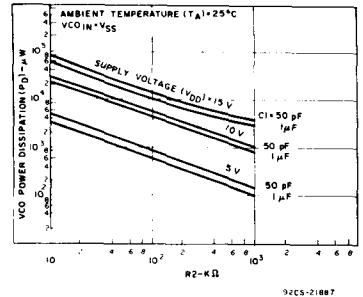

Fig.6(b) - Typical VCO power dissipation at  $f_{\text{min}}$  vs  $R_2$ .

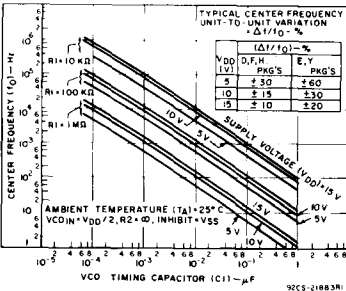

Fig.5(a) - Typical center frequency vs  $C_1$  for  $R_1 = 10\text{ k}\Omega$ , and  $1\text{ M}\Omega$  and  $f_0 \sim 1/R_1 C_1$ .

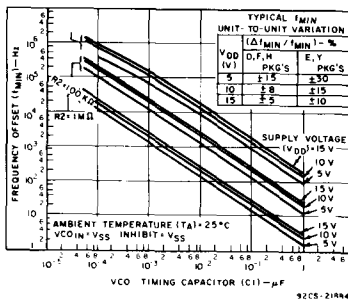

Fig.5(b) - Typical frequency offset vs  $C_1$  for  $R_2 = 10\text{ k}\Omega$ ,  $100\text{ k}\Omega$ , and  $1\text{ M}\Omega$ .

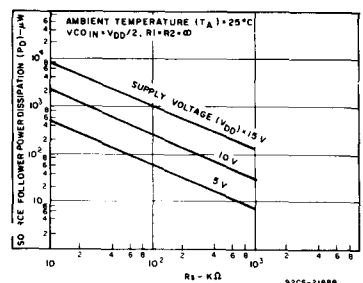

Fig.6(c) - Typical source follower power dissipation vs  $R_S$ .

NOTE: Lower frequency values are obtainable if larger values of  $C_1$  than shown in Figs. 5(a) and 5(b) are used.

NOTE: To obtain approximate total power dissipation of PLL system for no-signal input  
 $P_D(\text{Total}) = P_D(f_0) + P_D(f_{\text{MIN}}) + P_D(R_S)$  - Phase Comparator I  
 $P_D(\text{Total}) = P_D(f_{\text{MIN}})$  - Phase Comparator II

# CD4046A Types

## DESIGN INFORMATION (Cont'd):

Characteristics	Phase Comparator Used	Design Information	
Locks On Harmonic of Center Frequency	1	Yes	
	2	No	
Signal Input Noise Rejection	1	High	
	2	Low	
VCO Component Selection	1	<b>VCO WITHOUT OFFSET</b> $R_2 = \infty$ - Given: $f_0$ - Use $f_0$ with Fig.5a to determine R1 and C1	<b>VCO WITH OFFSET</b> - Given: $f_0$ and $f_L$ - Calculate $f_{min}$ from the equation $f_{min} = f_0 - f_L$ - Use $f_{min}$ with Fig.5b to determine R2 and C1 - Calculate $\frac{f_{max}}{f_{min}}$ from the equation $f_{max} = \frac{f_0 + f_L}{f_0 - f_L}$ - Use $\frac{f_{max}}{f_{min}}$ with Fig.5c to determine ratio R2/R1 to obtain R1
		2	- Given: $f_{max}$ - Calculate $f_0$ from the equation $f_0 = \frac{f_{max}}{2}$ - Use $f_0$ with Fig.5a to determine R1 and C1

For further information, see

(1) F. Gardner, "Phase-Lock Techniques" John Wiley and Sons, New York, 1966

(2) G. S. Moschytz, "Miniaturized RC Filters Using Phase-Locked Loop", BSTJ, May, 1965.

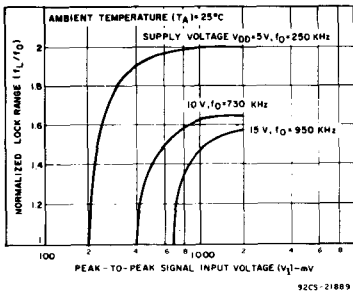

Fig.7 - Typical lock range vs signal input amplitude.

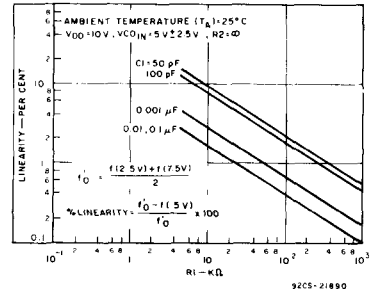
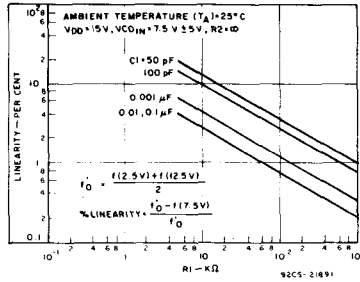

Fig.8(a) and (b) - Typical VCO linearity vs R1 and C1.

# CMOS Low-Power Monostable/Astable Multivibrator

The RCA-CD4047A consists of a gatable astable multivibrator with logic techniques incorporated to permit positive or negative edge-triggered monostable multivibrator action with retriggering and external counting options.

Inputs include +TRIGGER, -TRIGGER, ASTABLE, ASTABLE, RETRIGGER, and EXTERNAL RESET. Buffered outputs are Q, Q-bar, and OSCILLATOR. In all modes of operation an external capacitor must be connected between C-Timing and RC-Common terminals, and an external resistor must be connected between the R-Timing and RC-Common terminals.

Astable operation is enabled by a high level on the ASTABLE input. The period of the square wave at the Q and Q-bar Outputs in this mode of operation is a function of the external components employed. "True" input pulses on the ASTABLE input or "Complement" pulses on the ASTABLE input allow the circuit to be used as a gatable multivibrator. The OSCILLATOR output period will be half of the Q terminal output in the astable mode. However, a 50% duty cycle is not guaranteed at this output.

In the monostable mode, positive-edge triggering is accomplished by application of a leading-edge pulse to the +TRIGGER input and a low level to the -TRIGGER input. For negative-edge triggering, a trailing-edge pulse is applied to the -TRIGGER and a high level is applied to the +TRIGGER. Input pulses may be of any duration relative to the output pulse. The multivibrator can be retriggered (on the leading edge only) by applying a common pulse to both the RETRIGGER and +TRIGGER inputs. In this mode the output pulse remains high as long as the RETRIGGER input is high, with or without transitions.

An external countdown option can be implemented by coupling "Q" to an external "N" counter and resetting the counter with the trigger pulse. The counter output pulse is fed back to the ASTABLE input and has a duration equal to N times the period of the multivibrator.

A high level on the EXTERNAL RESET input assures no output pulse during an "ON" power condition. This input can also be activated to terminate the output pulse at any time. In the monostable mode, a high-level or power-on reset pulse, must be applied to the EXTERNAL RESET whenever VDD is applied.

These types are supplied in 14-lead hermetic dual-in-line ceramic packages (D and F suffixes), 14-lead dual-in-line plastic packages (E suffix), 14-lead ceramic flat packages (K suffix), and in chip form (H suffix).

**Features:**

- Low power consumption: special COS/MOS oscillator configuration
- Monostable (one-shot) or astable (free-running) operation
- True and complemented buffered outputs
- Only one external R and C required
- Quiescent current specified to 15 V
- Maximum input leakage current of 1 µA at 15 V (full package-temperature range)
- 1-V noise margin (full package-temperature range)

**Monostable Multivibrator Features:**

- Positive- or negative-edge trigger
- Output pulse width independent of trigger pulse duration
- Retriggerable option for pulse width expansion
- Long pulse widths possible using small RC components by means of external counter provision
- Fast recovery time essentially independent of pulse width
- Pulse-width accuracy maintained at duty cycles approaching 100%

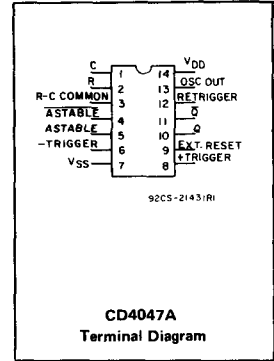

**Astable Multivibrator Features:**

- Free-running or gatable operating modes
- 50% duty cycle
- Oscillator output available
- Good astable frequency stability:
  - Frequency deviation:
    - = ±2% + 0.03%/°C @ 100 kHz
    - = ±0.5% + 0.015%/°C @ 10 kHz
    - (circuits "trimmed" to frequency VDD = 10 V ± 10%)

**Applications :**

- Digital equipment where low-power dissipation and/or high noise immunity are primary design requirements:
- Envelope detection
  - Frequency multiplication
  - Frequency division
  - Frequency discriminators
  - Timing circuits
  - Time-delay applications

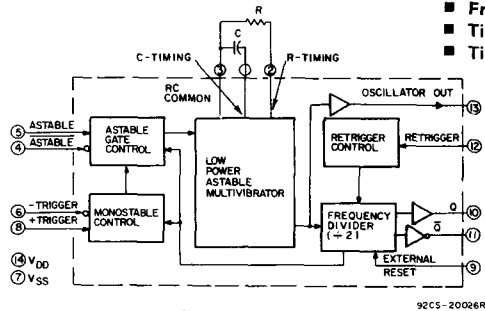

Fig. 1 - CD4047A logic block diagram.

**MAXIMUM RATINGS, Absolute-Maximum Values:**

STORAGE-TEMPERATURE RANGE (T <sub>stg</sub> )	..... -65 to +150°C
OPERATING-TEMPERATURE RANGE (T <sub>A</sub> ):	
PACKAGE TYPES D, F, K, H	..... -55 to +125°C
PACKAGE TYPE E	..... -40 to +85°C
DC SUPPLY-VOLTAGE RANGE, (V <sub>DD</sub> )	
(Voltages referenced to V <sub>SS</sub> Terminal):	..... -0.5 to +15 V
POWER DISSIPATION PER PACKAGE (P <sub>D</sub> )	
FOR T <sub>A</sub> = -40 to +60°C (PACKAGE TYPE E)	..... 500 mW
FOR T <sub>A</sub> = +60 to +85°C (PACKAGE TYPE E)	..... Derate Linearly at 12 mW/°C to 200 mW
FOR T <sub>A</sub> = -55 to +100°C (PACKAGE TYPES D, F, K)	..... 500 mW
FOR T <sub>A</sub> = +100 to +125°C (PACKAGE TYPES D, F, K)	..... Derate Linearly at 12 mW/°C to 200 mW
DEVICE DISSIPATION PER OUTPUT TRANSISTOR	
FOR T <sub>A</sub> = FULL PACKAGE-TEMPERATURE RANGE (ALL PACKAGE TYPES)	..... 100 mW
INPUT VOLTAGE RANGE, ALL INPUTS	..... -0.5 to V <sub>DD</sub> +0.5 V
LEAD TEMPERATURE (DURING SOLDERING):	
At distance 1/16 ± 1/32 inch (1.59 ± 0.79 mm) from case for 10 s max.	..... +265°C

# CD4047A Types

**RECOMMENDED OPERATING CONDITIONS at  $T_A = 25^\circ\text{C}$ , Except as Noted.**  
 For maximum reliability, nominal operating conditions should be selected so that operation is always within the following ranges:

CHARACTERISTIC	$V_{DD}$	LIMITS				UNITS
		D, F, K, H Packages		E Package		
		Min.	Max.	Min.	Max.	
Supply-Voltage Range (For $T_A = \text{Full Package-Temperature Range}$ )		3	12	3	12	V
Input Pulse Width, $t_{PW}$ (Any Input)	5 10	1000 400	— —	1300 600	— —	ns
Trigger, Retrigger Rise or Fall Time, $t_r, t_f$	5 10	— —	15 5	— —	15 5	$\mu\text{s}$

## STATIC ELECTRICAL CHARACTERISTICS

Characteristics	Conditions			Limits at Indicated Temperatures ( $^\circ\text{C}$ )								Units
				D, F, K, H Packages				E Package				
	$V_O$ (V)	$V_{IN}$ (V)	$V_{DD}$ (V)	-55	+25		+125	-40	+25		+85	
Quiescent Device Current $I_L$ Max.	—	—	5	5	0.03	5	300	50	0.1	50	700	$\mu\text{A}$
	—	—	10	10	0.05	10	600	100	0.2	100	1400	
	—	—	15	50	1	50	2000	500	5	500	5000	
Output Voltage: Low-Level, $V_{OL}$	—	5	5	0 Typ.; 0.05 Max.								V
	—	10	10	0 Typ.; 0.05 Max.								
High Level $V_{OH}$	—	0	5	4.95 Min.; 5 Typ.								V
	—	0	10	9.95 Min.; 10 Typ.								
Noise Immunity: Inputs Low, $V_{NL}$	4.2	—	5	1.5 Min.; 2.25 Typ.								V
	9	—	10	3 Min.; 4.5 Typ.								
Inputs High $V_{NH}$	0.8	—	5	1.5 Min.; 2.25 Typ.								V
	1	—	10	3 Min.; 4.5 Typ.								
Noise Margin: Inputs Low, $V_{NML}$	4.5	—	5	1 Min.								V
	9	—	10	1 Min.								
Inputs High, $V_{NMH}$	0.5	—	5	1 Min.								V
	1	—	10	1 Min.								
Output Drive Current: ( $Q, \bar{Q}$ Outputs) n-channel (Sink), $I_{DN}$ Min.	0.5	—	5	0.5	0.8	0.4	0.28	0.34	0.8	0.28	0.23	mA
	0.5	—	10	1.25	2	1	0.7	0.85	2	0.7	0.6	
p-Channel (Source): $I_{DP}$ Min.	4.5	—	5	-0.5	-0.8	-0.4	-0.28	-0.34	-0.8	-0.28	-0.23	mA
	9.5	—	10	-1.25	-2	-1	-0.7	-0.85	-2	-0.7	-0.6	
Input Leakage Current, $I_{IL}, I_{IH}$	Any Input			$\pm 10^{-5}$ Typ., $\pm 1$ Max.								$\mu\text{A}$

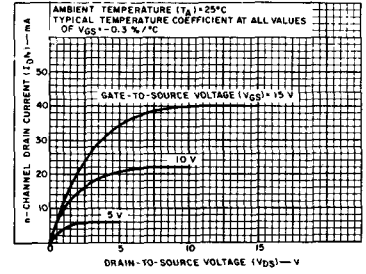

Fig. 2 — Typical output n-channel drain characteristics for  $Q$  and  $\bar{Q}$  buffers.

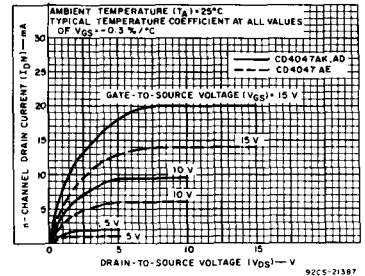

Fig. 3 — Minimum output n-channel drain characteristics for  $Q$  and  $\bar{Q}$  buffers.

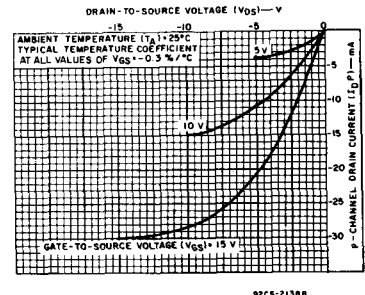

Fig. 4 — Typical output p-channel drain characteristics for  $Q$  and  $\bar{Q}$  buffers.

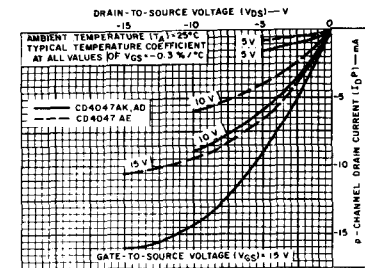

Fig. 5 — Minimum output p-channel drain characteristics for  $Q$  and  $\bar{Q}$  buffers.

# CD4047A Types

DYNAMIC ELECTRICAL CHARACTERISTICS at  $T_A = 25^\circ\text{C}$ , Input  $t_r, t_f = 20\text{ ns}$ ,  $C_L = 15\text{ pF}$ ,  
 $R_L = 200\text{ k}\Omega$

CHARACTERISTICS	TEST CONDITIONS	LIMITS						UNITS	
		VDD (Volts)	D, F, K, H Packages			E Package			
			Min.	TYP.	MAX.	Min.	TYP.		MAX.
Propagation Delay Time: $t_{PHL}, t_{PLH}$ Astable, Astable to Osc. Out	5	-	200	400	-	200	550	ns	
	10	-	100	200	-	100	275		
Astable, Astable to Q, $\bar{Q}$	5	-	550	900	-	550	1200		
	10	-	250	500	-	250	650		
+Trigger, -Trigger to Q, $\bar{Q}$	5	-	700	1200	-	700	1600		
	10	-	300	600	-	300	800		
+Trigger, Retrigger to Q, $\bar{Q}$	5	-	300	600	-	300	800		
	10	-	175	300	-	175	400		
External Reset to Q, $\bar{Q}$	5	-	300	600	-	300	800		
	10	-	125	250	-	125	350		
Transition Time: $t_{THL}, t_{TLH}$ Q, $\bar{Q}$	5	-	75	125	-	75	150	ns	
	10	-	45	75	-	45	100		
Osc. Out	5	-	75	150	-	75	180		
	10	-	45	100	-	45	130		
Minimum Input Pulse Width (any input), $t_W^*$	5	-	500	1000	-	500	1300	ns	
	10	-	200	400	-	200	600		
+Trigger, Retrigger Rise & Fall Time, $t_r, t_f$	5	-	-	15	-	-	15	$\mu\text{s}$	
	10	-	-	5	-	-	5		
Average Input Capacitance, $C_i$	Any Input	-	-	5	-	-	5	pF	

\* Input pulse widths below the minimum specified may cause malfunction of the unit.  
 See Application Note ICAN - 6230

## CD4047A FUNCTIONAL TERMINAL CONNECTIONS

NOTE: IN ALL CASES EXTERNAL RESISTOR BETWEEN TERMINALS 2 AND 3▲  
 EXTERNAL CAPACITOR BETWEEN TERMINALS 1 AND 3▲

FUNCTION	TERMINAL CONNECTIONS			OUTPUT PULSE FROM	OUTPUT PERIOD OR PULSE WIDTH
	TO VDD	TO VSS	INPUT PULSE TO		
Astable Multivibrator: Free Running True Gating Complement Gating	4,5,6,14	7,8,9,12	-	10,11,13	$t_A(10,11)=4.40\text{ RC}$ $t_A(13)=2.20\text{ RC}$
	4,6,14	7,8,9,12	5	10,11,13	
	6,14	5,7,8,9,12	4	10,11,13	
Monostable Multivibrator: Positive-Edge Trigger Negative-Edge Trigger Retriggerable External Countdown*	4,14	5,6,7,9,12	8	10,11	$t_M(10,11)=2.48\text{ RC}$
	4,8,14	5,7,9,12	6	10,11	
	4,14	5,6,7,9	8,12	10,11	
	14	5,6,7,8,9,12	-	10,11	

\* Input Pulse to Reset of External Counting Chip External Counting Chip Output To Terminal 4 ▲ See Text.

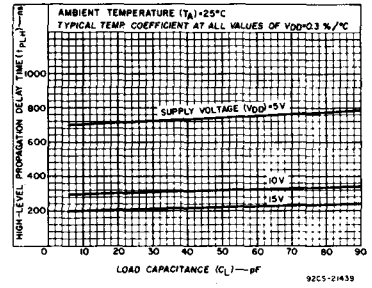

Fig. 6 - Typical low-to-high level propagation delay time vs load capacitance for Q and  $\bar{Q}$  buffers.

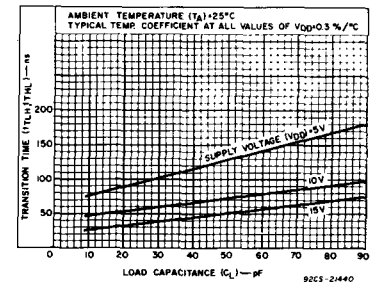

Fig. 7 - Typical transition time vs load capacitance for Q and  $\bar{Q}$  buffers.

## I. Astable Mode Design Information A. Unit-to-Unit Transfer-Voltage Variations.

The following analysis presents worst-case variations from unit to unit as a function of transfer-voltage ( $V_{TR}$ ) shift (33%–67%  $V_{DD}$ ) for free-running (astable) operation.

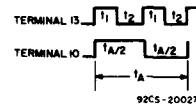

Fig. 8 - Astable mode waveforms.

$$t_1 = -RC \ln \frac{V_{TR}}{V_{DD} + V_{TR}}$$

$$t_2 = -RC \ln \frac{V_{DD} - V_{TR}}{2V_{DD} - V_{TR}}$$

$$t_A = 2(t_1 + t_2)$$

$$= -2RC \ln \frac{(V_{TR})(V_{DD} - V_{TR})}{(V_{DD} + V_{TR})(2V_{DD} - V_{TR})}$$

Typ:  $V_{TR} = 0.5 V_{DD}$   $t_A = 4.40\text{ RC}$   
 Min:  $V_{TR} = 0.33 V_{DD}$   $t_A = 4.62\text{ RC}$   
 Max:  $V_{TR} = 0.67 V_{DD}$   $t_A = 4.62\text{ RC}$

thus if  $t_A = 4.40\text{ RC}$  is used, the maximum variation will be (+5.0%, -0.0%).

# CD4047A Types

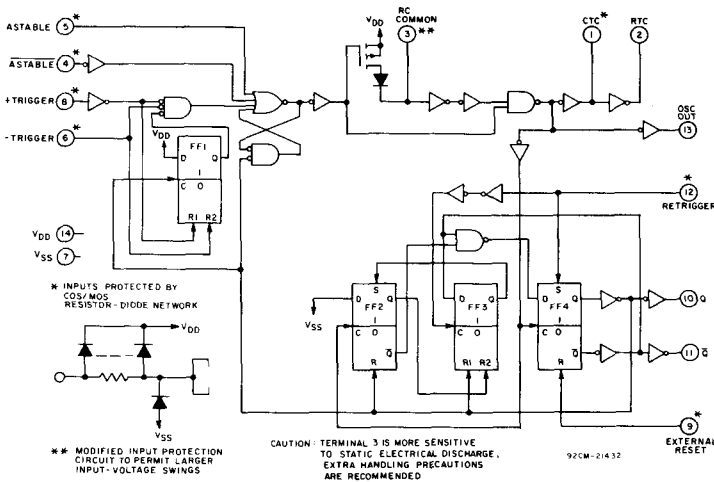

Fig. 9 - CD4047A logic diagram.

## B. Variations Due to $V_{DD}$ and Temperature Changes

In addition to variations from unit to unit, the astable period may vary as a function of frequency with respect to

$V_{DD}$  and temperature. Typical variations are presented in graphical form in Figs. 10 to 20 with 10 V as reference for voltage variation curves and 25°C as reference for temperature variation curves.

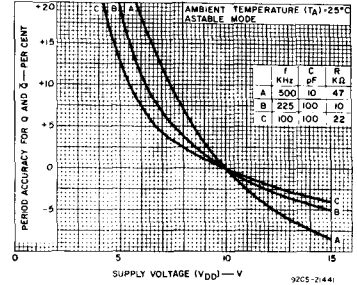

Fig. 10 - Typical Q and  $\bar{Q}$  period accuracy vs supply voltage (high frequency).

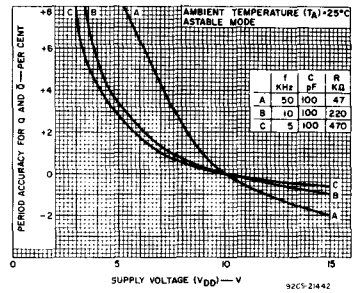

Fig. 11 - Typical Q and  $\bar{Q}$  period accuracy vs supply voltage (medium frequency).

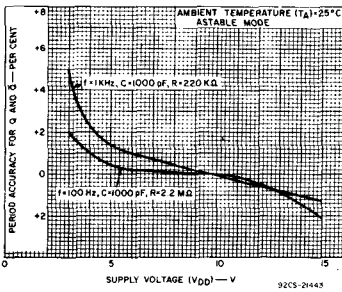

Fig. 12 - Typical Q and  $\bar{Q}$  period accuracy vs supply voltage (low frequency).

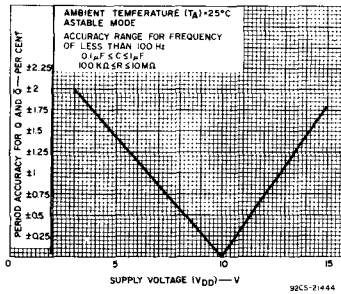

Fig. 13 - Typical Q and  $\bar{Q}$  period accuracy vs supply voltage (very low frequency).

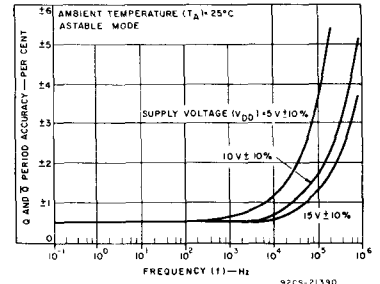

Fig. 14 - Typical Q and  $\bar{Q}$  period accuracy vs frequency for  $V_{DD}$  variation of  $\pm 10\%$  from value indicated.

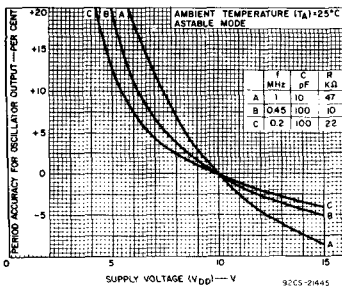

Fig. 15 - Typical oscillator-output period accuracy vs supply voltage (high frequency).

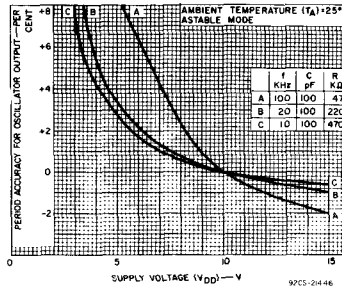

Fig. 16 - Typical oscillator-output period accuracy vs supply voltage (medium frequency).

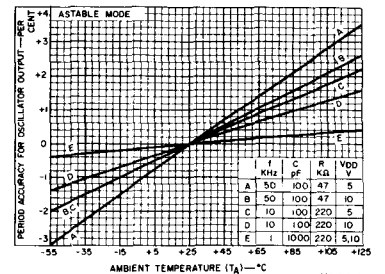

Fig. 17 - Typical Q and  $\bar{Q}$  period accuracy vs temperature (medium frequency).



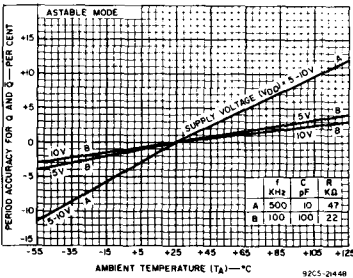

Fig. 18 — Typical Q- and Q̄-period accuracy vs temperature (high frequency).

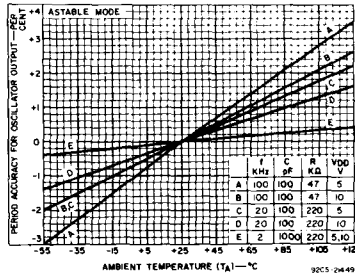

Fig. 19 — Typical oscillator-period accuracy vs temperature (medium frequency).

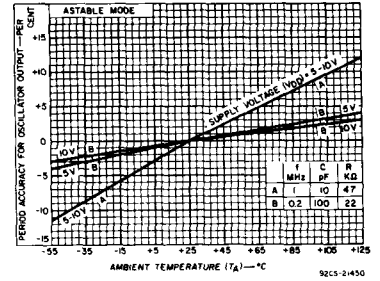

Fig. 20 — Typical oscillator-period accuracy vs temperature (high frequency).

II. Monostable Mode Design Information

The following analysis presents worst-case variations from unit to unit as a function of transfer-voltage (V<sub>TR</sub>) shift (33% – 67% V<sub>DD</sub>) for one-shot (monostable) operation.

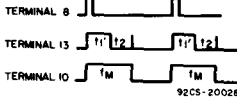

Fig. 21 — Monostable waveforms.

$$t_1' = -RC \ln \frac{V_{TR}}{2V_{DD}}$$

$$t_M = (t_1' + t_2)$$

$$t_M = -RC \ln \frac{(V_{TR})(V_{DD} - V_{TR})}{(2V_{DD} - V_{TR})(2V_{DD})}$$

where t<sub>M</sub> = Monostable mode pulse width.  
Values for t<sub>M</sub> are as follows:

- Typ: V<sub>TR</sub> = 0.5 V<sub>DD</sub> t<sub>M</sub> = 2.48 RC
- Min: V<sub>TR</sub> = 0.33 V<sub>DD</sub> t<sub>M</sub> = 2.71 RC
- Max: V<sub>TR</sub> = 0.67 V<sub>DD</sub> t<sub>M</sub> = 2.48 RC

Thus if t<sub>M</sub> = 2.48 RC is used, the maximum variation will be (+9.3%, -0.0%).

Note:

In the astable mode, the first positive half cycle has a duration of T<sub>M</sub>; succeeding durations are t<sub>A</sub>/2.

In addition to variations from unit to unit, the monostable pulse width may vary as a function of frequency with respect to V<sub>DD</sub> and temperature. These variations are presented in graphical form in Fig. 22 to 27 with 10 V as reference for voltage-variation curves and 25°C as reference for temperature-variation curves.

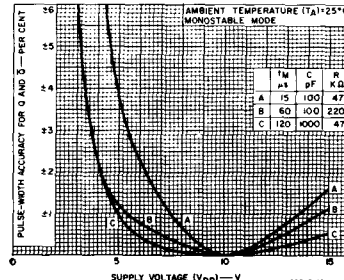

Fig. 22 — Typical Q- and Q̄-pulse-width accuracy vs supply voltage (t<sub>M</sub> = 15, 60, 120 μs).

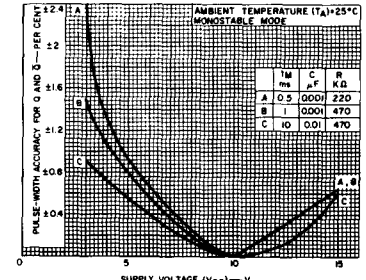

Fig. 23 — Typical Q- and Q̄-pulse-width accuracy vs supply voltage (t<sub>M</sub> = 0.5, 1, 10 ms).

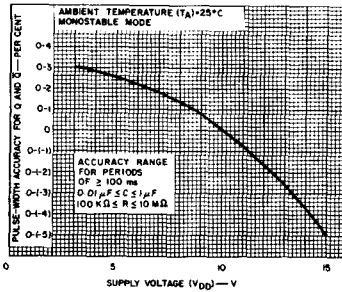

Fig. 24 — Typical Q- and Q̄-pulse-width accuracy vs supply voltage (t<sub>M</sub> ≥ 100 ns).

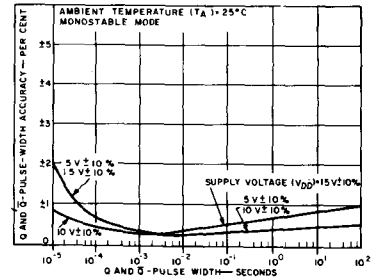

Fig. 25 — Typical Q- and Q̄ pulse-width accuracy vs Q and Q̄ pulse width for a variation of ± 10% from value indicated.

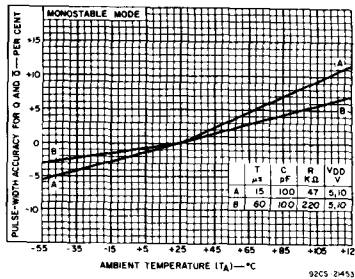

Fig. 26 — Typical Q and Q̄ pulse-width accuracy vs temperature (high frequency).

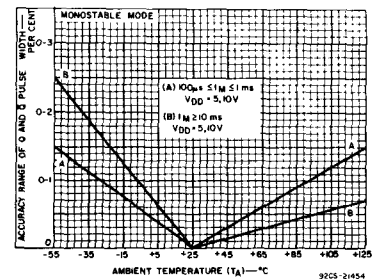

Fig. 27 — Typical Q and Q̄ pulse-width accuracy range vs temperature.

# CD4047A Types

## III. Retrigger Mode Operation

The CD4047A can be used in the retrigger mode to extend the output-pulse duration, or to compare the frequency of an input signal with that of the internal oscillator. In the retrigger mode the input pulse is applied to terminals 8 and 12, and the output is taken from terminal 10 or 11. As shown in Fig. 28, normal monostable action is obtained when one retrigger pulse is applied. Extended pulse duration is obtained when more than one pulse is applied. For two input pulses,  $t_{RE} = t_1 + t_1 + 2t_2$ . For more than two pulses,  $t_{RE}$  (Q OUTPUT), terminates at some variable time,  $t_D$ , after the termination of the last retrigger pulse,  $t_D$  is variable because  $t_{RE}$  (Q OUTPUT) terminates after the second positive edge of the oscillator output appears at flip-flop 4 (see Fig. 8).

## IV. External Counter Option

Time  $t_M$  can be extended by any amount with the use of external counting circuitry. Advantages include digitally controlled pulse duration, small timing capacitors for long time periods, and extremely fast recovery time. A typical implementation is shown in Fig. 29. The pulse duration at the output is  $t_{ext} = (N-1)(t_A) + (t_M + t_A/2)$  where  $t_{ext}$  = pulse duration of the circuitry, and N is the number of counts used.

## V. Timing-Component Limitations

The capacitor used in the circuit should be non-polarized and have low leakage (i.e. the parallel resistance of the capacitor should be an order of magnitude greater than the external resistor used). There is no upper or lower limit for either R or C value to maintain oscillation. However, in consideration of accuracy, C must be much larger than the inherent stray capacitance in the system (unless this capacitance can be measured and taken into account). R must be much larger than the CMOS "ON" resistance in series with it, which typically is hundreds of ohms. In addition, with very large values of R, some short-term instability with respect to time may be noted. The recommended values for these components to maintain agreement with previously calculated formulas without trimming should be:

- $C \geq 100$  pF, up to any practical value, for astable modes;
- $C \geq 1000$  pF, up to any practical value for monostable modes.

$$10 \text{ k}\Omega \leq R \leq 1 \text{ M}\Omega$$

## VI. Power Consumption

In the standby mode (Monostable or Astable), power dissipation will be a function of leakage current in the circuit, as shown in the static electrical characteristics. For dynamic operation, the power needed to charge the external timing capacitor C is given by the following formulae:

Astable Mode:  $P = 2CV^2f$ . (Output at terminal No. 13)  
 $P = 4CV^2f$ . (Output at terminal Nos. 10 and 11)

Monostable Mode:

$$P = \frac{(2.9CV^2) (\text{Duty Cycle})}{T}$$

(Output at terminal Nos. 10 and 11)

The circuit is designed so that most of the total power is consumed in the external components. In practice, the lower the values of frequency and voltage used, the closer the actual power dissipation will be to the calculated value.

Because the power dissipation does not depend on R, a design for minimum power dissipation would be a small value of C. The value of R would depend on the desired period (within the limitations discussed above). See Figs. 30-32 for typical power consumption in astable mode.

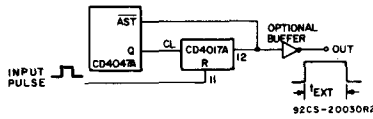

Fig. 28 - Implementation of external counter option.

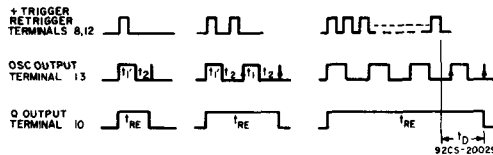

Fig. 29 - Retrigger-mode waveforms.

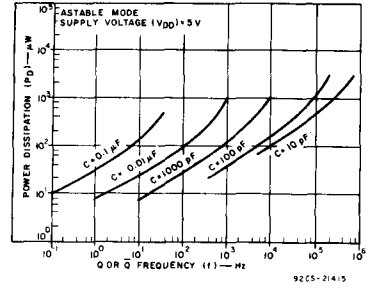

Fig. 30 - Power dissipation vs output frequency ( $V_{DD} = 5$  V).

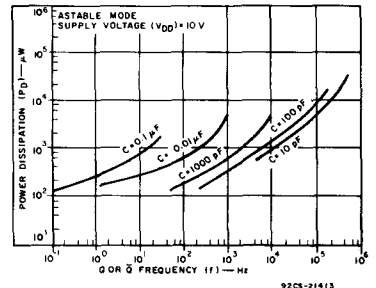

Fig. 31 - Power dissipation vs output frequency ( $V_{DD} = 10$  V).

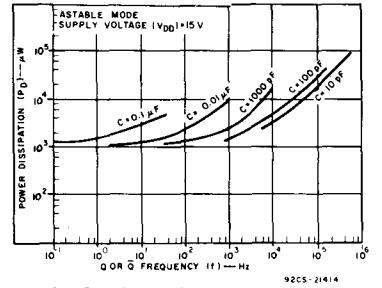

Fig. 32 - Power dissipation vs output frequency ( $V_{DD} = 15$  V).

## CMOS Multi-Function Expandable 8-Input Gate

The RCA-CD4048A is an 8-input gate having four control inputs. Three binary control inputs — Ka, Kb, and Kc — provide the implementation of eight different logic functions. These functions are OR, NOR, AND, NAND, OR/AND, OR/NAND, AND/OR, and AND/NOR.

A fourth control input — Kd — provides the user with 3-state outputs. When control input Kd is high the output is either a logic 1 or a logic 0 depending on the input states. When control input Kd is low, the output is

an open circuit. This feature enables the user to connect this device to a common bus line.

In addition to the eight input lines, an EXPAND input is provided that permits the user to increase the number of inputs to one CD4048A, (see Fig. 6). For example, two CD4048A's can be cascaded to provide a 16-input multifunction gate. When the EXPAND input is not used, it should be connected to VSS.

### MAXIMUM RATINGS, Absolute-Maximum Values:

STORAGE-TEMPERATURE RANGE ( $T_{stg}$ )	.....	-65 to +150°C
OPERATING-TEMPERATURE RANGE ( $T_A$ ):		
PACKAGE TYPES D, F, K, H	.....	-55 to +125°C
PACKAGE TYPE E	.....	-40 to +85°C
DC SUPPLY-VOLTAGE RANGE, ( $V_{DD}$ )		
(Voltages referenced to $V_{SS}$ Terminal):	.....	-0.5 to +15 V
POWER DISSIPATION PER PACKAGE ( $P_D$ )		
FOR $T_A = -40$ to $+60^\circ\text{C}$ (PACKAGE TYPE E)	.....	.500 mW
FOR $T_A = +60$ to $+85^\circ\text{C}$ (PACKAGE TYPE E)	.....	.Derate Linearly at 12 mW/ $^\circ\text{C}$ to 200 mW
FOR $T_A = -55$ to $+100^\circ\text{C}$ (PACKAGE TYPES D, F, K)	.....	.500 mW
FOR $T_A = +100$ to $+125^\circ\text{C}$ (PACKAGE TYPES D, F, K)	.....	.Derate Linearly at 12 mW/ $^\circ\text{C}$ to 200 mW
DEVICE DISSIPATION PER OUTPUT TRANSISTOR		
FOR $T_A = \text{FULL PACKAGE-TEMPERATURE RANGE (ALL PACKAGE TYPES)}$	.....	.100 mW
INPUT VOLTAGE RANGE, ALL INPUTS	.....	-0.5 to $V_{DD} + 0.5$ V
LEAD TEMPERATURE (DURING SOLDERING):		
At distance 1/16 ± 1/32 inch (1.59 ± 0.79 mm) from case for 10 s max.	.....	+265°C

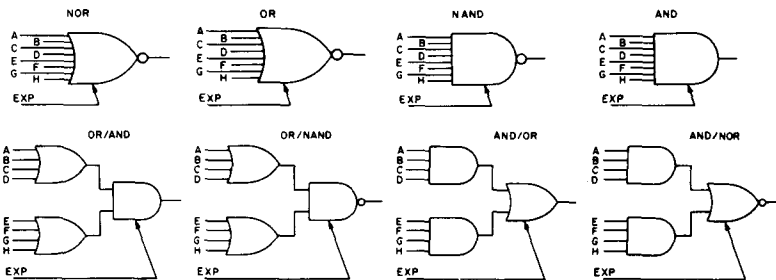

Fig. 1 - Basic logic configurations.

### RECOMMENDED OPERATING CONDITIONS

For maximum reliability, nominal operating conditions should be selected so that operation is always within the following ranges:

CHARACTERISTIC	$V_{DD}$ (V)	LIMITS				UNITS
		D, F, K, H Packages		E Package		
		Min.	Max.	Min.	Max.	
Supply-Voltage Range (For $T_A = \text{Full Package-Temperature Range}$ )		3	12	3	12	V

These types are supplied in 16-lead hermetic dual-in-line ceramic packages (D and F suffixes), 16-lead dual-in-line plastic package (E suffix), 16-lead ceramic flat package (K suffix), and in chip form (H suffix).

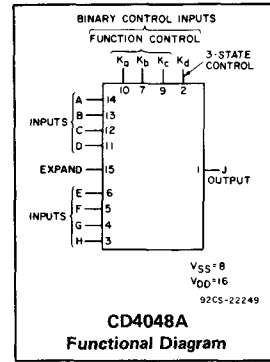

### Features:

- Medium-power TTL drive capability
- Three-state output
- High current source and sink capability  
9 mA (typ.) @  $V_{DS} = 0.5$  V,  $V_{DD} = 10$  V
- Many logic functions available in one package
- Quiescent current specified to 15 V
- Maximum input leakage current of 1  $\mu\text{A}$  at 15 V (full package-temperature range)
- 1-V noise margin (full package-temperature range)

### Applications:

- Selection of up to 8 logic functions
- Digital control of logic
- General-purpose gating logic
  - Decoding
  - Encoding

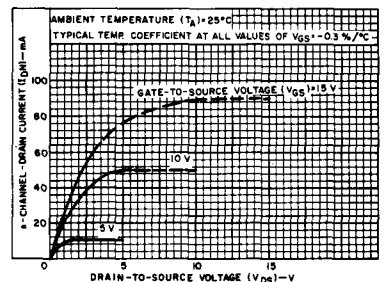

Fig. 2 - Typical output n-channel drain characteristics.

# CD4048A Types

## STATIC ELECTRICAL CHARACTERISTICS

Characteristic	Conditions			Limits at Indicated Temperatures (°C)								Units
				D, F, K, H Packages				E Package				
	V <sub>O</sub> (V)	V <sub>IN</sub> (V)	V <sub>DD</sub> (V)	-55	+25		+125	-40	+25		+85	
			Typ.	Limit	Typ.	Limit	Typ.	Limit	Typ.	Limit	Typ.	Limit
Quiescent Device Current I <sub>L</sub> Max.	-	-	5	1	0.005	1	60	10	0.01	10	140	μA
	-	-	10	2	0.01	2	120	20	0.02	20	280	
	-	-	15	25	0.5	25	1000	250	2.5	250	2500	
Output Voltage: Low Level, V <sub>OL</sub>	-	5	5	0 Typ.; 0.05 Max.								V
	-	10	10	0 Typ.; 0.05 Max.								
High Level V <sub>OH</sub>	-	0	5	4.95 Min.; 5 Typ.								V
	-	0	10	9.95 Min.; 10 Typ.								
Noise Immunity: Inputs Low, V <sub>NL</sub>	4.2	-	5	1.5 Min.; 2.25 Typ.								V
	9	-	10	3 Min.; 4.5 Typ.								
Inputs High V <sub>NH</sub>	0.8	-	5	1.5 Min.; 2.25 Typ.								V
	1	-	10	3 Min.; 4.5 Typ.								
Noise Margin: Inputs Low, V <sub>NML</sub>	4.5	-	5	1 Min.								V
	9	-	10	1 Min.								
Inputs High, V <sub>NMH</sub>	0.5	-	5	1 Min.								V
	1	-	10	1 Min.								
Output Drive Current: n-Channel(Sink) I <sub>DN</sub> Min.	0.4	-	4.5	2	3.2	1.6	1.1	1.9	3.2	1.6	1.3	mA
	0.5	-	10	5.6	9	4.5	3.1	5.4	9	4.5	3.7	
p-channel (Source), I <sub>DP</sub> Min.	4.6	-	5	-2	-3.2	-1.6	-1.1	-1.9	-3.2	-1.6	-1.3	mA
	9.5	-	10	-5.6	-9	-4.5	-3.1	-3.8	-9	-3.15	-2.6	
Input Leakage Current, I <sub>IL</sub> , I <sub>IH</sub>	Any Input			±10 <sup>-5</sup> Typ., ±1 Max.								μA
3-State Output Leakage Current I <sub>OL</sub> , I <sub>OH</sub>	Forced (Output Disabled)			±10 <sup>-4</sup> Typ., ±2 Max.								μA

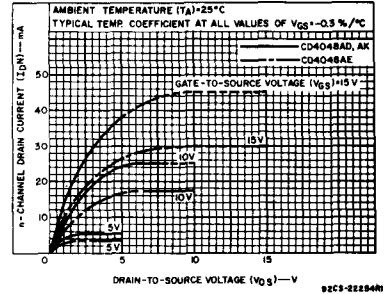

Fig. 3— Minimum output n-channel drain characteristics

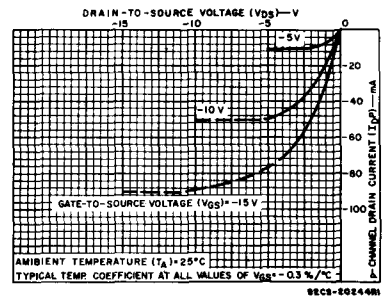

Fig. 4— Typical output p-channel drain characteristics.

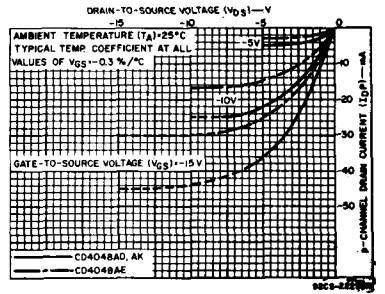

Fig. 5— Minimum output p-channel drain characteristics.

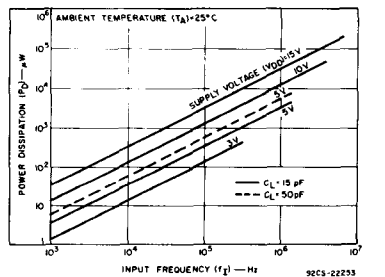

Fig. 6— Typical power dissipation as a function of input frequency.

# CD4048A Types

**DYNAMIC ELECTRICAL CHARACTERISTICS** at  $T_A = 25^\circ\text{C}$  and  $C_L = 15\text{ pF}$  and  $50\text{ pF}$ ,  
 Typical Temperature Coefficient for all values of  $V_{DD} = 0.3\%/^\circ\text{C}$   $R_L = 200\text{ k}\Omega$   
 $C_L = 15\text{ pF}$

CHARACTERISTIC	TEST CONDITIONS	LIMITS				UNITS	
		D, F, K, H Packages		E Package			
		$V_{DD}$ (Volts)	TYP.	MAX.*	TYP.		MAX.*
Propagation Delay Time $t_{PHL}$		5	750	1300	750	1600	ns
		10	225	400	225	500	
Transition Time: High-to-Low Level $t_{THL}$		5	90	140	90	170	ns
		10	30	50	30	65	
Low-to-High Level $t_{TLH}$		5	130	250	130	300	ns
		10	40	60	40	75	
Input Capacitance $C_I$	Any Input		5	—	5	—	pF

$C_L = 50\text{ pF}$

Propagation Delay Time $t_{PLH}, t_{PHL}$		5	775	1350	775	1650	ns
		10	240	430	240	530	
Transition Time: High-to-Low Level $t_{THL}$		5	105	170	105	200	ns
		10	40	70	40	85	
Low-to-High Level $t_{TLH}$		5	145	280	145	330	ns
		10	50	80	50	95	
Input Capacitance $C_I$	Any Input		5	—	5	—	pF

\* Max. Limits represent worst-case limits for worst-case modes of operation shown in Figs. 15, 16, and 17.

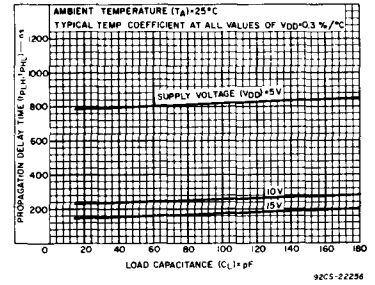

Fig. 7— Typical propagation delay time as a function of load capacitance.

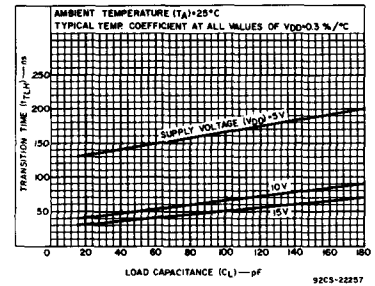

Fig. 8— Typical low-to-high level transition time as a function of load capacitance.

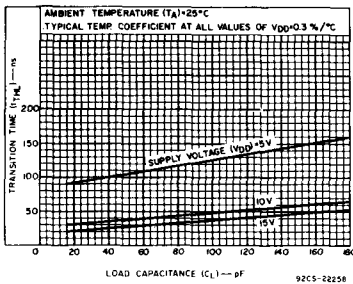

Fig. 9— Typical high-to-low level transition time as a function of load capacitance.

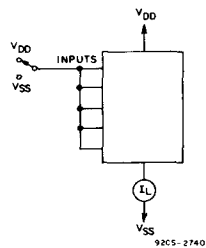

Fig. 10— Quiescent-device-current test circuit.

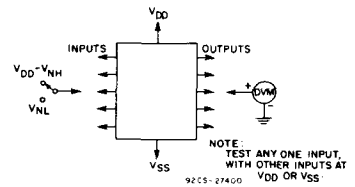

Fig. 11— Noise-immunity test circuit.

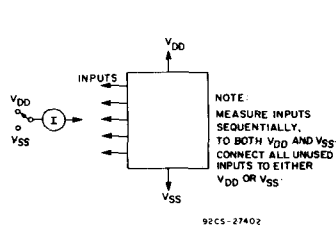

Fig. 12— Input-leakage-current test circuit.

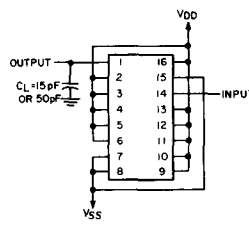
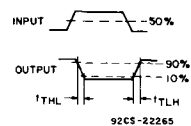

Fig. 13—  $t_{THL}$ ,  $t_{TLH}$  — AND/NOR.



# CD4048A Types

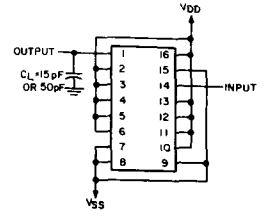
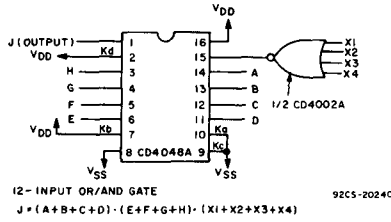
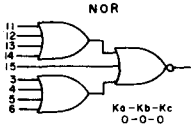

Fig. 14(a) - 12-input OR/AND gate.

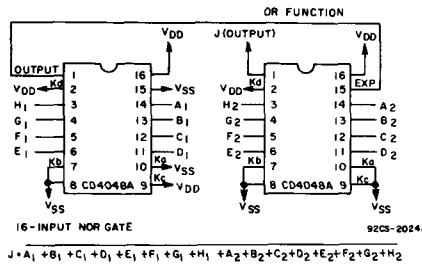
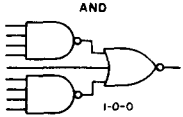

Fig. 15 -  $t_{PLH}$  - NAND.

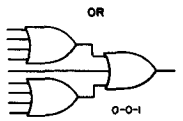
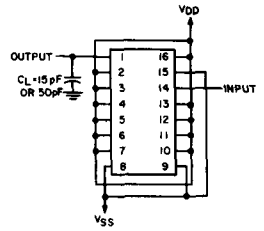

Fig. 14(b) 16-input NOR gate. Applications of Expand Input



## IMPLEMENTATION OF EXPAND INPUT FOR 9 OR MORE INPUTS

OUTPUT FUNCTION	FUNCTION NEEDED AT EXPAND INPUT	OUTPUT BOOLEAN EXPRESSION
NOR	OR	$J = \overline{(A+B+C+D+E+F+G+H) + (EXP)}$
OR	OR	$J = (A+B+C+D+E+F+G+H) + (EXP)$
AND	NAND	$J = \overline{ABCDEFHG} \cdot \overline{(EXP)}$
NAND	NAND	$J = \overline{ABCDEFHG} \cdot \overline{(EXP)}$
OR/AND	NOR	$J = \overline{(A+B+C+D) \cdot (E+F+G+H) \cdot (EXP)}$
OR/NAND	NOR	$J = \overline{(A+B+C+D) \cdot (E+F+G+H) \cdot (EXP)}$
AND/NOR	AND	$J = \overline{ABCD} + \overline{EFGH} + (EXP)$
AND/OR	AND	$J = \overline{ABCD} + \overline{EFGH} + (EXP)$

Note: (EXP) designates the EXPAND function (i.e.,  $X_1+X_2+...+X_N$ ).

Fig. 16 -  $t_{PHL}$  - AND.

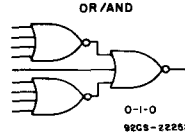
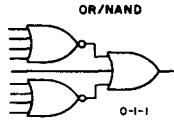
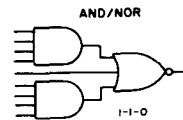
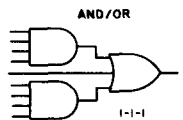
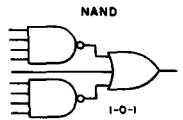
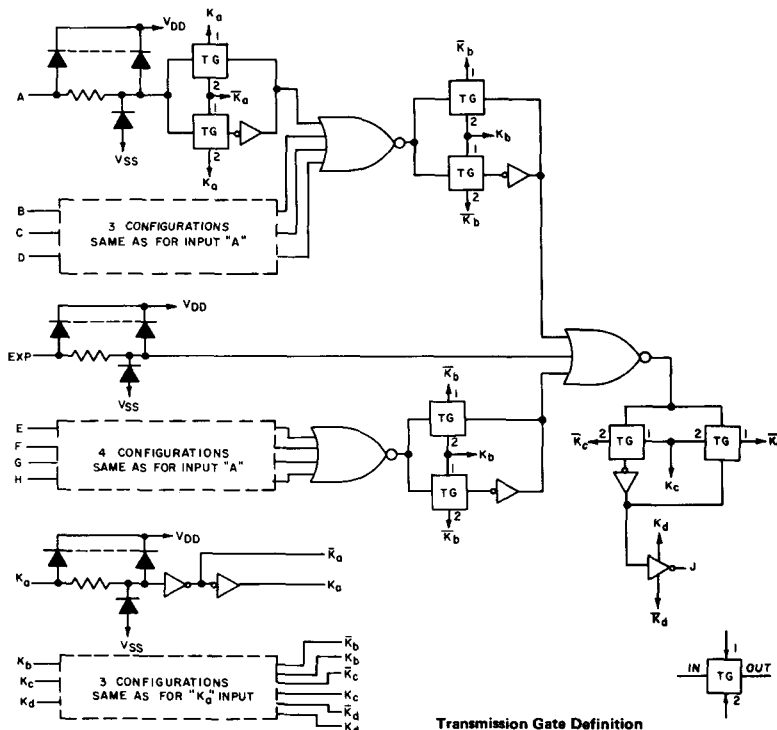

Fig. 14(c) Actual-circuit logic configurations.

Fig. 14 - Expansion logic and truth table.



**Transmission Gate Definition**

TG = Transmission Gate

Input to Output is:

- a) A bidirectional low impedance when control input 1 is low and control 2 is high.
- b) An open circuit when control input 1 is high and control input 2 is low.

92CM-2225RI

**FUNCTION TRUTH TABLE**

OUTPUT FUNCTION	BOOLEAN EXPRESSION	$K_a$	$K_b$	$K_c$	UNUSED INPUT*
NOR	$J = \overline{A+B+C+D+E+F+G+H}$	0	0	0	VSS
OR	$J = A+B+C+D+E+F+G+H$	0	0	1	VSS
OR/AND	$J = (A+B+C+D) \cdot (E+F+G+H)$	0	1	0	VSS
OR/NAND	$J = \overline{(A+B+C+D) \cdot (E+F+G+H)}$	0	1	1	VSS
AND	$J = ABCDEFGH$	1	0	0	VDD
NAND	$J = \overline{ABCDEFGH}$	1	0	1	VDD
AND/NOR	$J = \overline{ABCD} + EFGH$	1	1	0	VDD
AND/OR	$J = ABCD + EFGH$	1	1	1	VDD
$K_d=1$ Normal Inverter Action					
$K_d=0$ High Impedance Output					

EXPAND Input=0

\*See Figs. 1 and 7.

Fig. 17— Logic diagram and truth table.

# CD4049A, CD4050A Types

## CMOS Hex Buffer/Converters

CD4049A—Inverting Type  
 CD4050A—Non-Inverting Type

RECOMMENDED OPERATING CONDITIONS at  $T_A=25^\circ\text{C}$ , Except as Noted.  
 For maximum reliability, nominal operating conditions should be selected so that operation is always within the following ranges:

CHARACTERISTIC	LIMITS		UNITS
	Min.	Max.	
Supply Voltage Range ( $V_{CC}$ ) (For $T_A$ =Full Package Temperature Range)	3	12	V
Input Voltage Range ( $V_I$ )	$V_{CC}^*$	12	V

\*The CD4049 and CD4050 have high-to-low-level voltage conversion capability but not low-to-high-level; therefore it is recommended that  $V_I \geq V_{CC}$ .

The CD4049A and CD4050A are inverting and non-inverting hex buffers, respectively, and feature logic-level conversion using only one supply voltage ( $V_{CC}$ ). The input-signal high level ( $V_{IH}$ ) can exceed the  $V_{CC}$  supply voltage when these devices are used for logic-level conversions. These devices are intended for use as CMOS to DTL/TTL converters and can drive directly two DTL/TTL loads. ( $V_{CC}=5\text{ V}$ ,  $V_{OL} \geq 0.4\text{ V}$ , and  $I_{DN} \geq 3.2\text{ mA}$ .)

The CD4049A and CD4050A are designated as replacements for CD4009A and CD4010A, respectively. Because the CD4049A and CD4050A require only one power supply, they are preferred over the CD4009A and CD4010A and should be used in place of the CD4009A and CD4010A in all inverter, current driver, or logic-level conversion applications. In these applications the CD4049A and CD4050A are pin compatible with the CD4009A and CD4010A respectively, and can be substituted for these devices in existing as well as in new designs. Terminal No. 16 is not connected internally on the CD4049A or CD4050A, therefore, connection to this terminal is of no consequence to circuit operation. For applications not requiring high sink-current or voltage conversion, the CD4069 Hex Inverter is recommended.

These types are supplied in 16-lead hermetic dual-in-line ceramic packages (D and F suffixes), 16-lead dual-in-line plastic package (E suffix), 16-lead ceramic flat packages (K suffix), and in chip form (H suffix).

### Features:

- High sink current for driving 2 TTL loads
- High-to-low level logic conversion
- Quiescent current specified to 15  $\mu\text{A}$
- Maximum input leakage of 1  $\mu\text{A}$  at 15 V (full package-temperature range)

### Applications:

- CMOS to DTL/TTL hex converter
- CMOS current "sink" or "source" driver
- CMOS high-to-low logic-level converter

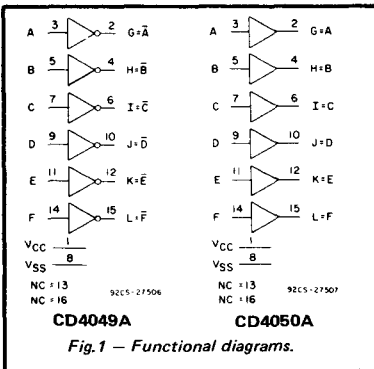

### STATIC ELECTRICAL CHARACTERISTICS

Characteristic	Conditions			Limits at Indicated Temperatures ( $^\circ\text{C}$ )								Units
				D, F, K, H Packages				E Package				
	$V_O$ (V)	$V_{IN}$ (V)	$V_{CC}$ (V)	-55	+25		+125	-40	+25		+85	
Quiescent Device Current, $I_L$ Max.	—	—	5	0.3	0.01	0.3	20	3	0.03	3	42	$\mu\text{A}$
	—	—	10	0.5	0.01	0.5	30	5	0.05	5	70	
	—	—	15	10	0.02	10	100	50	0.05	50	500	
Output Voltage: $V_{OL}$	—	0, 5	5	0 Typ.; 0.05 Max.								V
	—	0, 10	10	0 Typ.; 0.05 Max.								
	—	0, 5	5	4.95 Min.; 5 Typ.								
$V_{OH}$	—	0, 10	10	9.95 Min.; 10 Typ.								V
Noise Immunity: Inputs Low, $V_{NL}$	3.6	—	5	1.5 Min.; 2.25 Typ.								V
	7.2	—	10	3 Min.; 4.5 Typ.								
Inputs High, $V_{NH}$	1.4	—	5	1.5 Min.; 2.25 Typ.								V
	2.8	—	10	3 Min.; 4.5 Typ.								
All Types Inputs Low, $V_{NL}$	3.6	—	5	1 Min.; 1.5 Typ.								V
	7.2	—	10	2 Min.; 3 Typ.								
Noise Margin: Inputs Low, $V_{NML}$ Min.	4.5	—	5	1 Min.								V
	9	—	10	1 Min.								
Inputs High, $V_{NMH}$ Min.	0.5	—	5	1 Min.								V
	1	—	10	1 Min.								
Output Drive Current: N-Channel (Sink), $I_{DN}$ Min.	0.4	—	4.5	3.3	5.2	2.6	1.8	3.1	5.2	2.6	2.1	$\text{mA}$
	0.4	—	5	3.75	6	3	2.1	3.6	6	3	2.5	
	0.5	—	10	10	16	8	5.6	9.6	16	8	6.6	
	4.5	—	5	-0.62	-1	-0.5	-0.35	-0.6	-1	-0.5	-0.4	
	2.5	—	5	-1.85	-2.5	-1.25	-0.9	-1.5	-2.5	-1.25	-1	
P-Channel (Source), $I_{DP}$ Min.	2.5	—	5	-1.85	-2.5	-1.25	-0.9	-1.5	-2.5	-1.25	-1	$\text{mA}$
	9.5	—	10	-1.85	-2.5	-1.25	-0.9	-1.5	-2.5	-1.25	-1	
Input Leakage Current, $I_{IL}$ , $I_{IH}$ Max.	Any Input		15	$\pm 10^{-5}$ Typ., $\pm 1$ Max.								$\mu\text{A}$



# CD4049A, CD4050A Types

## MAXIMUM RATINGS, Absolute-Maximum Values:

STORAGE-TEMPERATURE RANGE ( $T_{stg}$ )	-65 to +150°C
OPERATING-TEMPERATURE RANGE ( $T_A$ ):	
PACKAGE TYPES D, F, K, H	-55 to +125°C
PACKAGE TYPE E	-40 to +85°C
DC SUPPLY-VOLTAGE RANGE, ( $V_{CC}$ )	-0.5 to +15 V
(Voltages referenced to $V_{SS}$ Terminal)	
POWER DISSIPATION PER PACKAGE ( $P_D$ ):	
FOR $T_A = -40$ to $+60^\circ\text{C}$ (PACKAGE TYPE E)	500 mW
FOR $T_A = +60$ to $+85^\circ\text{C}$ (PACKAGE TYPE E)	Derate Linearly at 12 mW/°C to 200 mW
FOR $T_A = -55$ to $+100^\circ\text{C}$ (PACKAGE TYPES D, F, K)	500 mW
FOR $T_A = +100$ to $+125^\circ\text{C}$ (PACKAGE TYPES D, F, K)	Derate Linearly at 12 mW/°C to 200 mW
DEVICE DISSIPATION PER OUTPUT TRANSISTOR	
FOR $T_A = \text{FULL PACKAGE-TEMPERATURE RANGE (ALL PACKAGE TYPES)}$	100 mW
INPUT VOLTAGE RANGE, ALL INPUTS	-0.5 to $V_{DD} + 0.5$ V
LEAD TEMPERATURE (DURING SOLDERING)	
At distance 1/16 ± 1/32 inch (1.59 ± 0.79 mm) from case for 10 s max.	+265°C

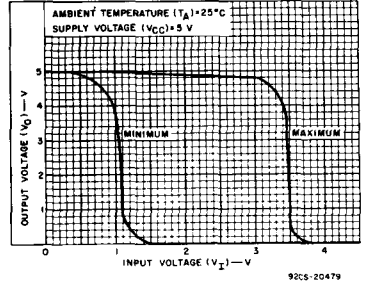

Fig. 2—Minimum and maximum voltage transfer characteristics for CD4049A.

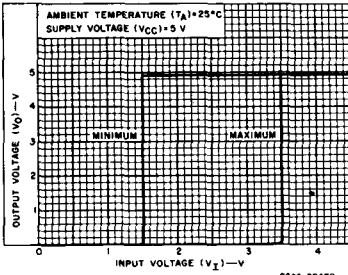

Fig. 3—Minimum and maximum voltage transfer characteristics for CD4050A.

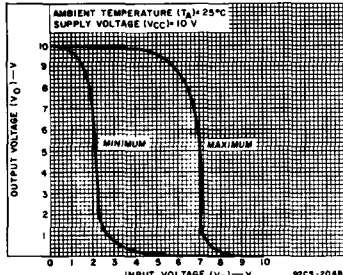

Fig. 4—Minimum and maximum voltage transfer characteristics for CD4049A.

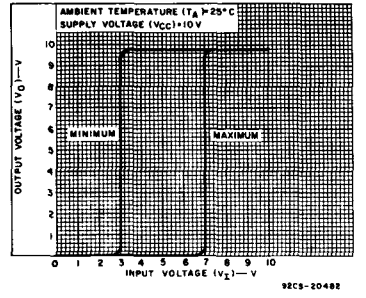

Fig. 5—Minimum and maximum voltage transfer characteristics for CD4050A.

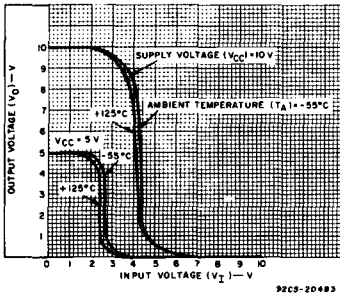

Fig. 6—Typical voltage transfer characteristics as a function of temperature for CD4049A.

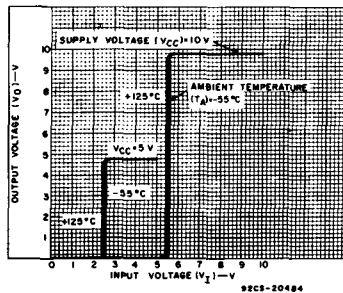

Fig. 7—Typical voltage transfer characteristics as a function of temperature for CD4050A.

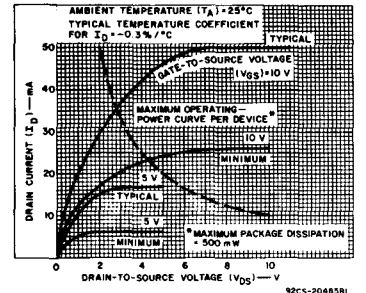

Fig. 8—Typical and minimum n-channel drain characteristics as a function of gate-to-source voltage ( $V_{GS}$ ) for CD4049A, CD4050A.

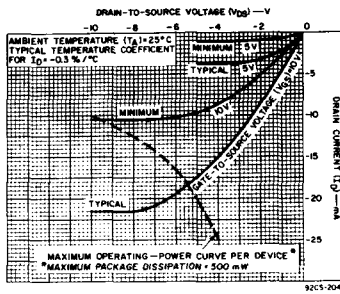

Fig. 9—Typical and minimum p-channel drain characteristics as a function of gate-to-source voltage ( $V_{GS}$ ) for CD4049A, CD4050A.

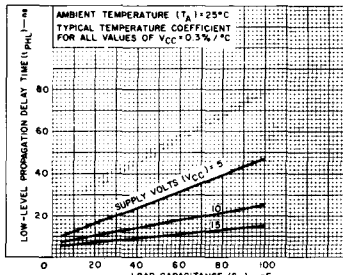

Fig. 10—Typical high-to-low level propagation delay time vs.  $C_L$  for CD4049A.

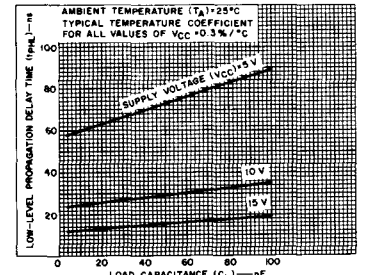

Fig. 11—Typical high-to-low level propagation delay time vs.  $C_L$  for CD4050A.

# CD4049A, CD4050A Types

DYNAMIC ELECTRICAL CHARACTERISTICS at  $T_A = 25^\circ\text{C}$ ; Input  $t_r, t_f = 20 \text{ ns}$ ,  $C_L = 15 \text{ pF}$ ,  $R_L = 200 \text{ k}\Omega$

CHARACTERISTIC	CONDITIONS		LIMITS ALL PKGS.		UNITS		
	$V_I$	$V_{CC}$	Typ.	Max.			
Propagation Delay Time: Low-to-High, $t_{PLH}$	CD4049A	5	5	50	80	ns	
		10	10	25	55		
	CD4050A	5	5	75	140	ns	
		10	10	35	85		
	High-to-Low, $t_{PHL}$	CD4049A	5	5	15	55	ns
			10	10	10	30	
CD4050A		5	5	55	110	ns	
		10	10	25	55		
Transition Time:		Low-to-High, $t_{TLH}$	5	5	50	100	ns
			10	10	30	60	
	High-to-Low, $t_{THL}$	5	5	20	45	ns	
		10	10	16	40		
Input Capacitance, $C_I$	CD4049A	—	—	15	—	pF	
	CD4050A	—	—	5	—		

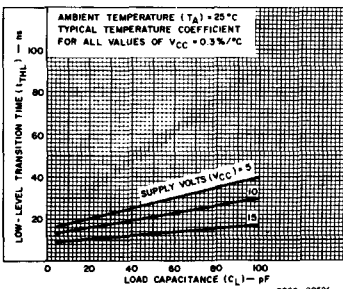

Fig. 14—Typical high-to-low level transition time vs.  $C_L$  for CD4049A, CD4050A.

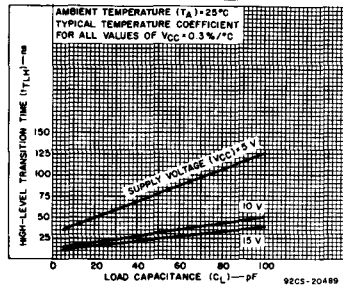

Fig. 15—Typical low-to-high level transition time vs.  $C_L$  for CD4049A, CD4050A.

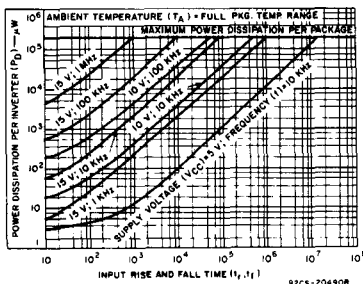

Fig. 17—Typical power dissipation vs. transition time per inverter CD4049A.

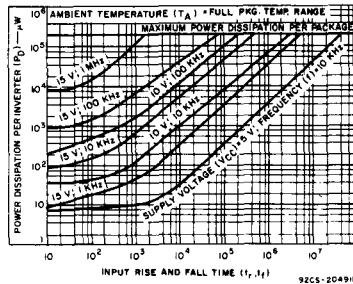

Fig. 18—Typical power dissipation vs. transition time per inverter CD4050A.

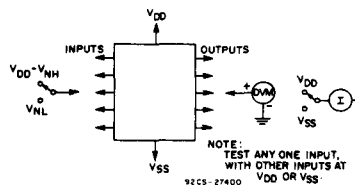

Fig. 19—Noise immunity test circuit.

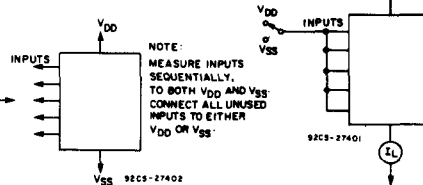

Fig. 20—Input leakage current test circuit.

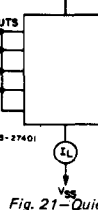

Fig. 21—Quiescent device current test circuit.

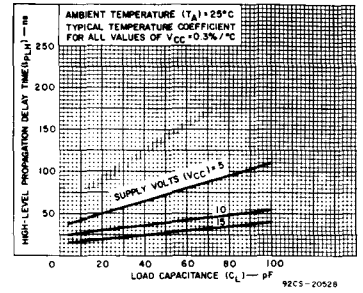

Fig. 12—Typical low-to-high level propagation delay time vs.  $C_L$  for CD4049A.

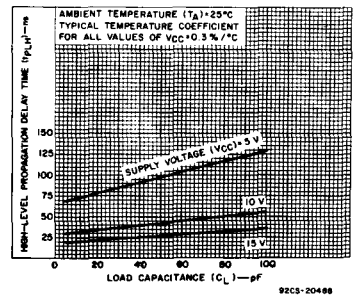

Fig. 13—Typical low-to-high level propagation delay time vs.  $C_L$  for CD4050A.

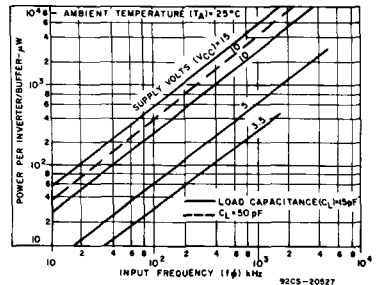

Fig. 16—Typical dissipation characteristics for CD4049A, CD4050A.

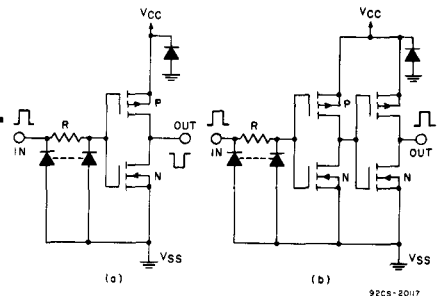

Fig. 22—(a) Schematic diagram of CD4049A, 1 of 6 identical units. (b) Schematic diagram of CD4050A, 1 of 6 identical units.

# CMOS LSI 4-Bit Arithmetic Logic Unit

The RCA-CD4057A is a low-power arithmetic logic unit (ALU) designed for use in LSI computers. An arithmetic system of virtually any size can be constructed by wiring together a number of CD4057A ALU's. The CD4057A provides 4-bit arithmetic operations, time sharing of data terminals, and full functional decoding for all control lines. The distributed control system of this device provides great flexibility in system designs by allowing hard-wired connection of N units in 4<sup>N</sup> unique combinations. Four control lines provide 16 instructions which include Addition, Subtraction, Bidirectional and Cycle Shifts, Up-Down Counting, AND, OR, and Exclusive-OR logic operations.

Two mode control lines allow the CD4057A to function as any 4-bit section of a larger arithmetic unit by controlling the bidirectional serial transfer of data to adjacent arithmetic arrays. By means of three "Conditional Control" lines Overflow, All Zeros, and Negative State conditions may be

### Applications:

- Parallel Arithmetic Units
- Process Controllers
- Remote Data Sets
- Graphic Display Terminals

detected and used to establish a conditional operation. Predetermined operation of the CD4057A on a conditional basis allows greater ALU flexibility. Although especially applicable as a parallel arithmetic unit, the CD4057A also finds use in virtually any application requiring one or more of its 16 basic instructions. The CD4057A is supplied in a hermetically sealed 28-lead dual-in-line ceramic package (CD4057AD), 28-lead ceramic flat package (CD4057AK), and in chip form (CD4057AH).

### MAXIMUM RATINGS, Absolute-Maximum Values:

STORAGE-TEMPERATURE RANGE (T <sub>stg</sub> )	-65 to +150°C
OPERATING-TEMPERATURE RANGE (T <sub>A</sub> ):	
PACKAGE TYPES D, K, H	-55 to +125°C
DC SUPPLY-VOLTAGE RANGE, (V <sub>DD</sub> )	
(Voltages referenced to V <sub>SS</sub> Terminal)	-0.5 to +15 V
POWER DISSIPATION PER PACKAGE (P <sub>D</sub> ):	
For T <sub>A</sub> = -55 to +100°C (PACKAGE TYPES D, K)	500 mW
For T <sub>A</sub> = +100 to +125°C (PACKAGE TYPES D, K)	Derate Linearly at 12 mW/°C to 200 mW
DEVICE DISSIPATION PER OUTPUT TRANSISTOR	
FOR T <sub>A</sub> = FULL PACKAGE-TEMPERATURE RANGE (ALL PACKAGE TYPES)	100 mW
INPUT VOLTAGE RANGE, ALL INPUTS	-0.5 to V <sub>DD</sub> +0.5 V
LEAD TEMPERATURE (DURING SOLDERING):	
At distance 1/16 ± 1/32 inch (1.59 ± 0.79 mm) from case for 10 s max.	+265°C

### RECOMMENDED OPERATING CONDITIONS

For maximum reliability, nominal operating conditions should be selected so that operation is always within the following ranges:

CHARACTERISTIC	V <sub>DD</sub> (V)	LIMITS		UNITS
		Min.	Max.	
Supply-Voltage Range (For T <sub>A</sub> = Full Package-Temperature Range)		3	12	V
Setup Time, t <sub>S</sub>	5	40	—	ns
	10	20	—	
DATA	5	4590	—	ns
	10	1320	—	
OP CODE	5	1200	—	ns
	10	375	—	
Clock Pulse Width, t <sub>W</sub>	5	1200	—	ns
Clock Input Frequency, f <sub>CL</sub>	5	0.13	—	MHz
	10	0.46	—	
Count Mode	5	0.33	—	MHz
	10	1.4	—	
Clock Rise or Fall Time, t <sub>r</sub> CL, t <sub>f</sub> CL	5	—	15	μs
	10	—	15	

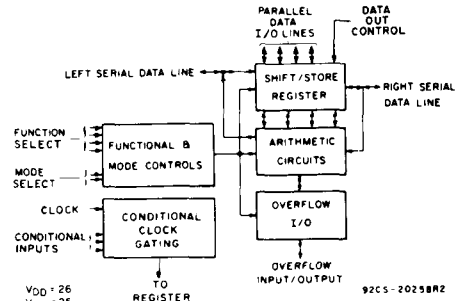

Fig. 1 - Block diagram - CD4057A.

### Features:

- LSI Complexity on a Single Chip
- 16-Instruction Capability
  - Add, Subtract, Count
  - AND, OR, Exclusive-OR
  - Right, Left, or Cyclic Shifts
- Bidirectional Data Busses
- Instruction Decoding on Chip
- Fully Static Operation
- Single-Phase Clocking
- Easily Expandable to 8, 12, 16, ... Bit Operation
- Low Quiescent Device Dissipation . . . . . 10 μW (typ.)
- Conditional-Operation Controls on Chip
- Add Time (Data In-To Sum Out) =375 ns (typ) at 10V
- Quiescent current specified to 15 V
- Maximum input leakage current of 1 μA at 15 V (full package-temperature range)
- 1-V noise margin (full package-temperature range)

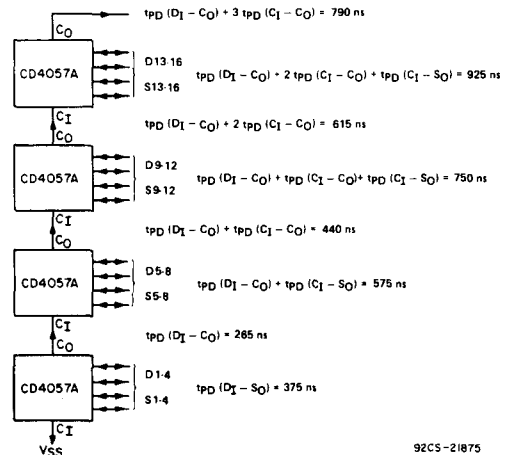

Fig. 2 - Typical speed characteristics of a 16-bit ALU at V<sub>DD</sub> = 10 V.

# CD4057A Types

## STATIC ELECTRICAL CHARACTERISTICS

CHARACTERISTIC	CONDITIONS			Limits at Indicated Temperatures (°C)						UNITS
				CD4057AD, CD4057AK, CD4057AH						
	V <sub>O</sub> (V)	V <sub>IN</sub> (V)	V <sub>DD</sub> (V)	-55°C		25°C		125°C		
			Min.	Max.	Min.	Typ.	Max.	Min.	Max.	
Quiescent Device Current I <sub>L</sub>	-	-	5	-	5	-	0.5	5	-	150
	-	-	10	-	10	-	1	10	-	300
	-	-	15	-	50	-	1	50	-	2000
Output Voltage; Low-Level, V <sub>OL</sub>	-	5	5	0 Typ.; 0.05 Max.						V
	-	10	10	0 Typ.; 0.05 Max.						
High Level, V <sub>OH</sub>	-	0	5	4.95 Min.; 5 Typ.						V
	-	0	10	9.95 Min.; 10 Typ.						
Noise Immunity (All Inputs) V <sub>NL</sub> , V <sub>NH</sub>	0.8	-	5	1.5 Min.; 2.25 Typ.						V
	1	-	10	3 Min.; 4.5 Typ.						
	4.2	-	5	1.5 Min.; 2.25 Typ.						
	9	-	10	3 Min.; 4.5 Typ.						
Noise Margin: Inputs Low, V <sub>NML</sub>	4.5	-	5	1 Min.						V
	9	-	10	1 Min.						
Inputs High, V <sub>NMH</sub>	0.5	-	5	1 Min.						V
	1	-	10	1 Min.						
Output Drive Current: I <sub>DN</sub> , I <sub>DP</sub> Zero Indicator	0.5	-	5	0.11	-	0.09	0.16	-	0.06	-
	n-channel	0.5	-	10	0.12	-	0.10	0.16	-	0.07
p-channel	3	-	5	0.04	-	0.03	0.06	-	0.02	-
	7	-	10	0.08	-	0.07	0.13	-	0.05	-
Negative Indicator	0.5	-	5	0.11	-	0.09	0.30	-	0.06	-
	n-channel	0.5	-	10	0.12	-	0.10	0.40	-	0.07
p-channel	4.5	-	5	0.07	-	0.06	0.19	-	0.04	-
	9.5	-	10	0.12	-	0.10	0.30	-	0.07	-
Overflow Indicator	0.5	-	5	0.25	-	0.20	0.50	-	0.14	-
	n-channel	0.5	-	10	0.37	-	0.30	0.90	-	0.21
p-channel	4.5	-	5	0.08	-	0.07	0.21	-	0.05	-
	9.5	-	10	0.12	-	0.10	0.38	-	0.07	-
All Other Outputs	0.5	-	5	0.11	-	0.09	0.10	-	0.06	-
	n-channel	0.5	-	10	0.06	-	0.05	0.12	-	0.03
p-channel	4.5	-	5	0.02	-	0.02	0.05	-	0.01	-
	9.5	-	10	0.06	-	0.05	0.08	-	0.03	-
Input Leakage Current I <sub>IL</sub> , I <sub>IH</sub>	-	-	15	± 10 <sup>-5</sup> Typ., ± 1 Max.						μA

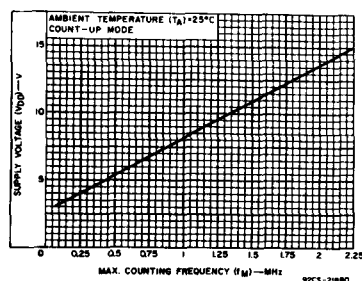

Fig. 3 - Maximum counting frequency vs. supply voltage for a typical CD4057A.

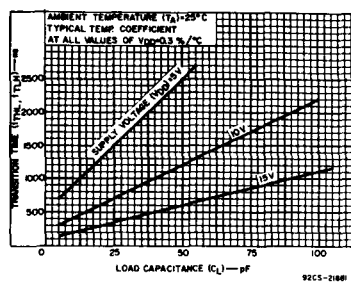

Fig. 4 - Transition time vs. load capacitance for data outputs (D1-D4).

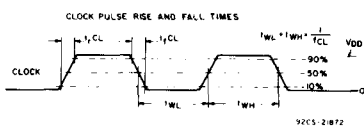

Fig. 5 - Clock pulse rise and fall times.

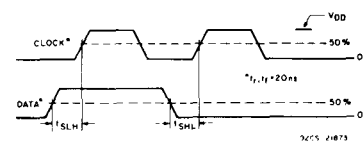

Fig. 6 - Data setup time.

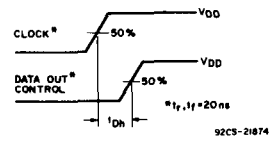

Fig. 7 - Data hold time.

# CD4057A Types

**DYNAMIC ELECTRICAL CHARACTERISTICS** at  $T_A = 25^\circ\text{C}$  and  $C_L = 15\text{ pF}$ ,  $R_L = 200\text{ k}\Omega$ ,  
 $t_r, t_f = 20\text{ ns}$   
 Typical Temperature Coefficient at all values of  $V_{DD} = 0.3\%/^\circ\text{C}$

## LOGIC DESCRIPTION

### OPERATIONAL MODES

The CD4057A arithmetic logic unit operates in one of four possible modes. These modes control the transfer of information, either serial data or arithmetic operation carries, to and from the serial-data lines. Fig. 8 shows the manner in which the four modes control the data on the serial-data lines.

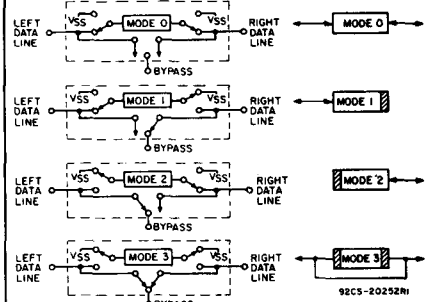

Fig. 8 - Schematic of "Mode" concept.

In MODE 0, data can enter or leave from either the left or the right serial-data line.

In MODE 1, data can enter or leave only on the left serial-data line.

In MODE 2, data can enter or leave only on the right serial-data line.

In MODE 3, serial data can neither enter nor leave the register, regardless of the nature of the operation. Furthermore, the register is by-passed electrically, i.e., there is an electrical bidirectional path between the right and left serial data terminals.

The two input lines labeled C1 and C2 in the terminal assignment diagram define one of four possible modes shown in Table I.

Through the use of mode control, individual arithmetic arrays can be cascaded to form one large processor or many processors of various lengths.

TABLE I - MODE DEFINITION

C2	C1	MODE
0	0	0
0	1	1
1	0	2
1	1	3

Examples of how one "hard-wired" combination of three ALU's can form (a) a 12-bit parallel processor, (b) one 8-bit and one 4-bit parallel processor, or (c) three 4-bit parallel processors, merely by changes in the modes of each ALU are shown in Fig. 10.

CHARACTERISTICS	TEST CONDITIONS	LIMITS CD4057AD, CD4057AK			UNITS
		VDD	Min.	Typ.	
Propagation Delay Time: $t_{PLH}, t_{PHL}$ DATA IN-to-SUM OUT  CARRY IN-to-SUM OUT  DATA IN-to-CARRY OUT  CARRY IN-to-CARRY OUT  Z1 Input -to- Z1 Output	5	—	1430	3900	ns
		10	—	375	
	5	—	915	2550	
		10	—	310	
	5	—	950	2580	
		10	—	265	
	5	—	485	1320	
		10	—	175	
5	—	1980	5400		
	10	—	750	2040	
	5	—	265	720	
	10	—	110	300	
Transition Time: $t_{TLH}, t_{THL}$ Z1 Output  Negative Indicator and Overflow Indicator  All Other Outputs	5	—	3700	10350	ns
		10	—	1650	
	5	—	420	1140	
		10	—	220	
	5	—	300	825	
		10	—	165	
5	—	1000	2775		
	10	—	475	1275	
Minimum Clock Pulse Width, $t_W$	5	—	400	1200	ns
		10	—	125	
Clock Rise and Fall Time, $t_{rCL}, t_{fCL}$	5	—	—	15	$\mu\text{s}$
		10	—	—	
Minimum Set Up Time : $t_{SLH}, t_{SHL}$ DATA	5	—	20	40	ns
		10	—	10	
OP CODE	5	—	1675	4590	ns
		10	—	485	
Minimum Data Hold Time, $t_{HLH}, t_{HHL}$	5	—	20	40	ns
		10	—	10	
Maximum Clock Frequency: $f_{CL}$ Count Mode  Shift Mode	5	0.13	0.36	—	MHz
		10	0.46	1.35	
	5	0.33	0.90	—	
		10	1.4	3.8	
Input Capacitance, $C_I$	ANY INPUT	—	5	—	pF



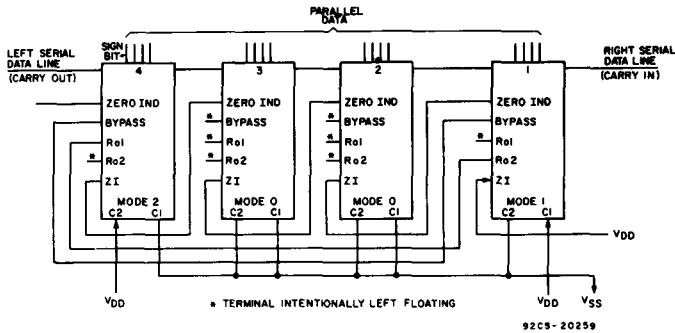

Fig. 11 — Connection for 16-bit arithmetic logic unit.

the count is presented on the parallel data lines (D1-D4).

### j. COUNT DOWN:

In Mode 0, subtracts a one (2's complement form) from the contents of the register and adds to this result the data on the right serial-data line and permits any resulting carry to leave on the left serial-data line. No data enters on the parallel-data lines.

In Mode 1, internally subtracts a one from the contents of the register and permits any resulting carry to leave on the left serial-data line. No data enters or leaves the right serial-data line.

In Mode 2, subtracts a one from the contents of the register and adds to this result the data on the right serial-data line. No data enters or leaves on the left serial-data line.

In Mode 3, internally subtracts a one from the contents of the register. No data enters or leaves on the serial-data lines.

In all modes, with the DATA OUT control high the count is presented on the parallel data lines (D1-D4).

### k. ADD(AD):

In Mode 0, adds the contents of the register to the data on the parallel-data lines and the right serial-data line. Any resulting carry can leave on the left serial-data line. The overflow indicator does not change state.

In Mode 1, adds the contents of the register to the data on the parallel-data lines and allows any resulting carry to leave on the left serial-data line. The right serial-data line is

open-circuited. The overflow indicator does not change state. The CARRY-IN is set to zero.

In Mode 2, adds the contents of the register to the data on the parallel data lines and the right serial-data line. Any overflow sets the overflow indicator. The left serial-data line is open-circuited. The absence or presence of an overflow is registered.

In Mode 3, adds contents of the register to the data on the parallel-data lines. Any resulting carry sets the overflow indicator. The two serial-data lines are open-circuited. The absence or presence of an overflow is registered. The CARRY-IN is set to zero.

l. **SM** — same operation as AD except the contents of the register are two's complemented during addition in Mode 1 and Mode 3. In Mode 0 or Mode 2, the contents of the register are one's complemented and added to the data on the right serial-data line and the parallel-data lines. Overflows occurring in Mode 1 or Mode 0 do not alter the overflow indicator. The presence or absence of overflows is registered on the overflow indicator in Mode 2 or Mode 3.

### m. SMZ:

In Mode 0, one's complements the contents of the register and adds the data on the right serial-data line to the contents of the register. Any resulting carry can leave on the left serial-data line. The overflow indicator does not change state.

In Mode 1, two's complements the contents of the register and permits any carry to leave on the left serial-data line. No data can enter the right serial-data

line. The overflow indicator does not change state. The CARRY-IN is set to zero.

In Mode 2, one's complements the contents of the register and adds the data on the right serial-data line to the contents of the register. Carries cannot leave the left serial data line. The absence or presence of an overflow alters the overflow indicator.

In Mode 3, two's complements the contents of the register. Serial data can neither enter the right serial-data line nor leave the left serial-data line. The overflow indicator is at zero. The CARRY-IN is set to zero.

n. **NO-OP** — no operation takes place. The clock input is inhibited and the state of all registers and indicators remains unchanged.

### SERIAL-SHIFT OPERATIONS

a. **ROTATE (cycle) RIGHT** — This operation is internal. The contents of the register shift to the right, cyclic fashion with the leftmost stage accepting data from the rightmost stage regardless of the mode. Data can leave the register serially on the right data line only while the register is in Mode 1 or Mode 0. Data can enter the left data line serially while the register is in Mode 1 or Mode 0. The Ro1 terminal of the "Most Significant" CD4057A must be connected to the Ro2 terminal of the "Least Significant" CD4057A. All other Ro1 and Ro2 terminals must be left floating. When only one CD4057A is used, Ro1 must be connected to Ro2.

b. **RIGHT SHIFT** — The contents of the register shift to the right and serial operations are as follows:

In Mode 0, data can enter serially on the left data line, shift through the register, and leave on the right data line.

In Mode 1, data can enter serially on the left data line. The right data line effectively is open-circuited.

In Mode 2, data can leave serially on the right data line. The left data line effectively is open-circuited. Vacant spaces are filled with zeros.

In Mode 3, serial data can neither enter nor leave the register; however, the contents shift to the right and vacated places are filled with zeros.

## CD4057A Types

In all modes, with the DATA OUT control high the data is presented on the parallel data lines (D1-D4).

- c. **LEFT SHIFT** — The contents of the register shift to the left and serial operations are as follows;

In Mode 0, data can enter the right data line, shift through the register, and leave on the left data line.

In Mode 1, data can leave serially on the left data line. The right data line effectively is open-circuited. All vacant positions are filled with zeros.

In Mode 2, data can enter serially on the right data line. The left data line effectively is open-circuited.

In Mode 3, data can neither enter nor leave the register; however, the contents shift to the left, and vacated places are filled with zeros.

In all modes, with the DATA OUT control high the data is presented on the parallel data lines (D1-D4).

Because the "DATA OUT" control instruction is independent of the other 16 instructions, care must be taken not to activate this control when data are to be loaded into the processor. This instruction should only be activated when the processor is executing a NO-OP, any SHIFT, SMZ, COUNT UP or DOWN, CLEAR, or SET.

If a data line, serial or parallel, is used as an input and the logic state of that line is not defined (i.e., the line is an open circuit), then the result of any operation using that line is undefined.

### OPERATIONAL SEQUENCE FOR ARITHMETIC ADD CYCLE

1. Apply IN Instruction and Word A on Parallel Data Lines (D1-D4).
2. Apply CLOCK to load Word A into the register.
3. Apply OP CODE Instruction and Word B on Data Lines.
4. Apply CLOCK to load resulting function of A and B into the register.
5. Apply "DATA OUT" control to present result to Parallel Data Lines.

**NOTE:** Transitions of Step 2 and Step 3 may occur almost simultaneously; i.e. separated by only one data-hold time.

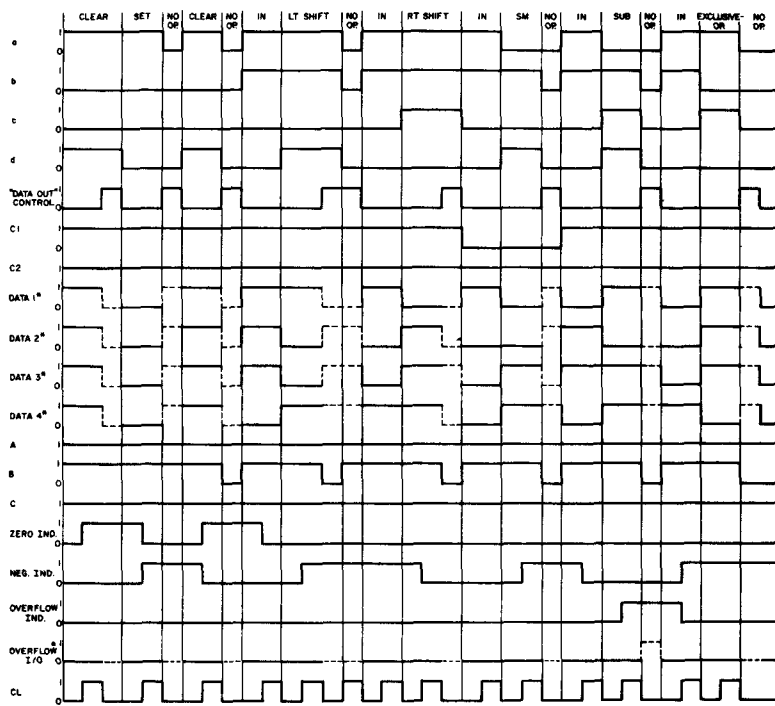

NOTES: R01 CONNECTED TO R02; BY-PASS IS OPEN; Z1 CONNECTED TO VDD; REGISTER IN MODE 3.  
\* SOLID LINE REPRESENTS INPUT FROM EXTERIOR SOURCE WHEN "DATA OUT" IS LOW; DASHED LINE REPRESENTS OUTPUT WHEN "DATA OUT" IS HIGH.

Fig. 12 — Timing diagram.

### NEGATIVE-NUMBER DETECTION

The NEG IND terminal of the CD4057A is connected to the output of the flip-flop that is in the most significant bit position. A "1" on the NEG IND terminal indicates a negative number is in the register. This detection is also independent of modes.

### ZERO DETECTION

The condition of "all zeros" is indicated by a "1" on the Zero Indicator terminal of the "Most Significant" CD4057A. As shown in Fig. 11, terminal Z1 of the CD4057A containing the least significant set of bits is connected to VDD. Zero indication is independent of modes.

### COMPLEMENTING NUMBERS

1. One's complement of number in ALU register.
  - a) ALU must be in MODE 0 or MODE 2.
  - b) Zero on Rt. Data Line.
  - c) Execute an SMZ instruction.

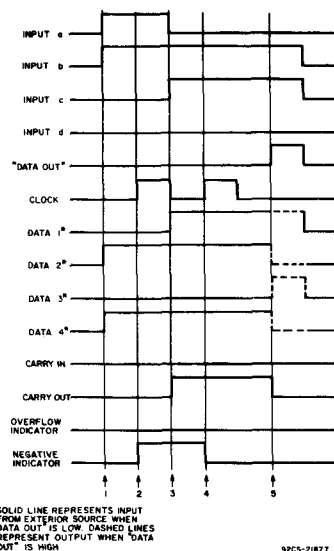

\* SOLID LINE REPRESENTS INPUT FROM EXTERIOR SOURCE WHEN "DATA OUT" IS LOW; DASHED LINES REPRESENT OUTPUT WHEN "DATA OUT" IS HIGH

92CS-21877

Fig. 13 — Add cycle waveforms.

(Continued)



2. One's complement of number to be loaded into ALU register.
  - a) If zero indicator output is low, execute a CLEAR instruction, and make Rt. Data Line = 0.
  - b) ALU must be in MODE 0 or MODE 2.
- c) Execute an SUB instruction.
3. Two's complement of number in ALU register.
  - a) ALU must be in MODE 1 or MODE 3.
  - b) Execute an SMZ instruction.
4. Two's complement of number to be loaded into ALU register.
  - a) If zero indicator output is low, execute a CLEAR instruction, and make Rt. Data Line = 0.
  - b) ALU must be in MODE 1 or MODE 3.
  - c) Execute an SUB instruction.

The following algorithms are given as a general guideline to demonstrate some of the capabilities of the CD4057A.

### MULTIPLICATION OF TWO N-BIT NUMBERS

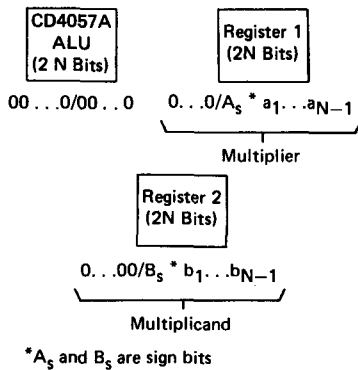

### Multiplication Algorithm

1. Clear ALU to Zero
2. Store A<sub>s</sub> ⊕ B<sub>s</sub> in External Flip-Flop.
3. If A<sub>s</sub> = 1, Complement Register 1.
4. If B<sub>s</sub> = 1, Complement Register 2.
5. Load Register 2 into ALU.
6. Do shift Left on ALU N Times (N = number of bits).
7. Do N Times:
  - (1)
    - a) If MSB of ALU = 1 (Negative Indicator = High), Then shift ALU left 1 bit; add Register 1 to ALU.
    - b) If MSB of ALU = 0 (Negative Indicator = Low) Then shift ALU left 1 bit.
8. If A<sub>s</sub> ⊕ B<sub>s</sub> = 1, then Complement ALU.
9. Answer in ALU.

### Division Algorithm

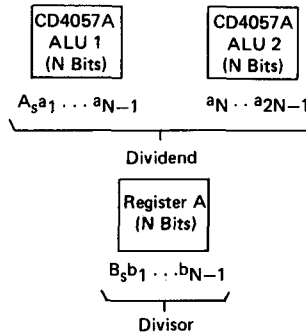

1. Store A<sub>s</sub> ⊕ B<sub>s</sub> in External Flip-Flop.
2. If A<sub>s</sub> = 1, complement ALU 1 and ALU 2.
3. If B<sub>s</sub> = 1, complement Register A.
4. Check for Divisor = 0
  - a) If Divisor = 0; stop, indicates division by 0.
  - b) If Divisor ≠ 0; continue.
5. Apply SUB instruction to ALU 1 and the contents of Register A to ALU 1 data lines.
6. Put a zero on RT data line of ALU 2 and shift ALU 1 & ALU 2 left 1 bit.
7. Do "N" times.
  - (1) Apply a sub instruction to ALU 1 and the contents of Register A to the ALU 1 data lines.
    - a) If C<sub>0</sub> = 1, then clock ALU 1, and put a 1 on right data line of ALU 2.
    - b) If C<sub>0</sub> = 0, then do not clock, and put a 0 on right data line of ALU 2.
  - (2) Shift left 1 bit.
8. If sign Flip Flop = 1, complement ALU 2.
9. Answer in ALU 2.

### CONDITIONAL OPERATION

Inhibition of the clock pulse can be accomplished with a programmed NO-OP instruction or through conditional input terminals A, B, and C. In a system of many CD4057A's, each CD4057A can be made to automatically control its own operation or the operation of any other CD4057A in the system in conjunction with the Overflow, Zero, or Negative (Number) indicators. Table II, the conditional inputs, truth table, defines the interactions among A, B, and C.

TABLE II - CONDITIONAL-INPUTS TRUTH TABLE

A	B	C	OPERATION PERMITTED
0	X	X	Yes
1	0	0	Yes
1	0	1	No
1	1	0	No
1	1	1	Yes

X = don't care

Two examples of how the conditional operation can be used are as follows:

- 1) For the Multiplication Algorithm

A = 1, for step 7 (1)  
 A = 0, for step 7 (2)  
 B = 1  
 C = negative Indicator

- 2) For the Division Algorithm

A = 1, for step 7 (1)  
 A = 0, for step 7 (2)  
 B = 1  
 C = C<sub>0</sub> (left data line)

### OVERFLOW DETECTION

The CD4057A is capable of detecting and indicating the presence or absence of an arithmetic two's-complement overflow. A two's-complement overflow is defined as having occurred if the signs of the two initial words are the same and the sign of the result is different while performing a carry-generating instruction.

For example: (+) 0.011  
 0.110  
 1.001

Overflows can be detected and indicated only during operation in Mode 2 or Mode 3 and can occur for only four instructions (AD, SMZ, SM, and SUB). If an overflow is detected and stored in the overflow flip-flop, any one of the five instructions AD, SMZ, SM, SUB, or IN can change the overflow indicator.

When any of the three subtraction instructions is used, the sign bit of the data being subtracted is complemented and this value is used as one of the two initial signs to detect overflows. If an overflow has occurred, the final sign of the sum or difference is one's complemented and stored in the most-significant-bit position of the register.

The overflow flip-flop is updated at the same time the new result is stored in the CD4057A. Whenever data on the parallel-data lines are loaded into the CD4057A, whatever is on the Overflow I/O line is loaded into the overflow flip-flop. Also, whenever data are dumped on the parallel data lines from the CD4057A, the contents of the overflow flip-flop are dumped on the Overflow I/O line. Thus overflows may be stored elsewhere and then fed into the CD4057A at another time.

# CD4057A Types

## OPERATIONAL SEQUENCE AND WAVEFORMS FOR PROPAGATION-DELAY MEASUREMENTS

### 1. DATA IN-to-CARRY OUT and DATA IN-to-SUM OUT

- Apply Word A and IN instruction
- Apply Clock to load word A into register
- Apply AD instruction
- Apply Word B (data in)
- Apply Clock to load result (sum out)
- Apply DATA OUT CONTROL to look at result

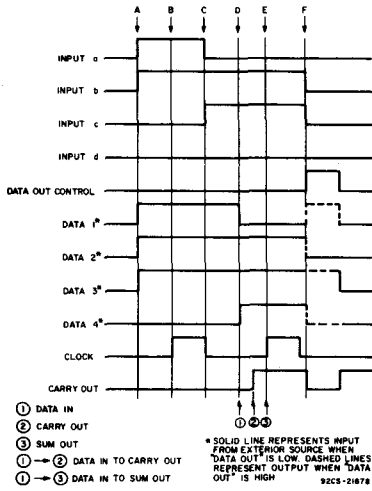

Fig. 14(a) - DATA IN-to-CARRY OUT and DATA IN-to-SUM OUT.

### 2. CARRY IN-to-CARRY OUT and CARRY IN-to-SUM OUT

- Apply Word A and IN instruction
- Apply Clock to load word A into register
- Apply AD instruction
- Apply Word B
- Apply CARRY IN (carry in)
- Apply Clock to load result (sum out)
- Apply DATA OUT CONTROL to look at result

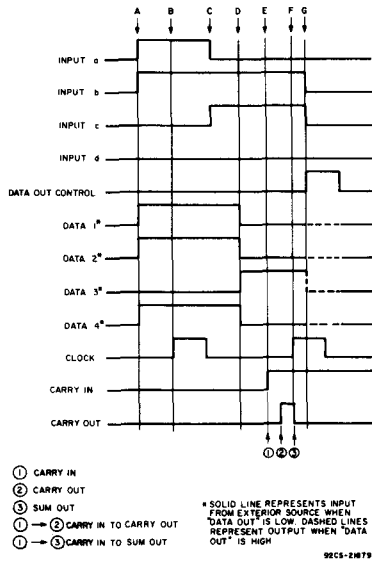

Fig. 14(b) - CARRY IN-to-CARRY OUT and CARRY IN-to-SUM OUT.

### TYPICAL APPLICATION

The CD4057A has been designed for use as a parallel processor in flexible, programmable, easily expandable, special or general purpose computers, where minimization of external

connections and data busing are primary design goals. The block diagram of Fig. 18 is an example of a computer that processes 8 bits in parallel.

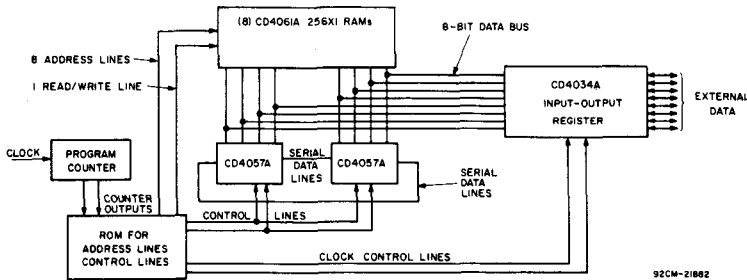

Fig. 18 - Example of computer organization using CD4057A.

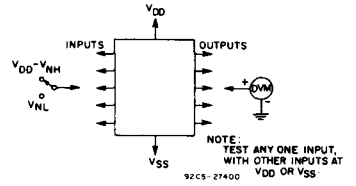

Fig. 15 - Noise-immunity test circuit.

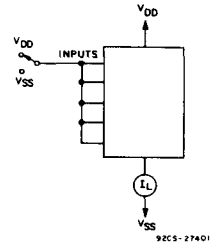

Fig. 16 - Quiescent-device-current test circuit.

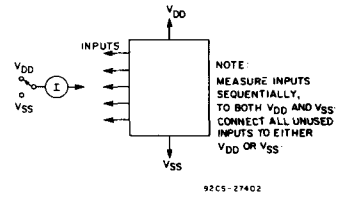

Fig. 17 - Input-leakage-current test circuit.

# CMOS Programmable Divide-by-"N" Counter

Standard "A"-Series Types (3-to-15-Volt Rating)

RCA-CD4059 standard "A"-Series types are divide-by-N down-counters that can be programmed to divide an input frequency by any number "N" from 3 to 15,999. The output signal is a pulse one clock-cycle wide occurring at a rate equal to the input frequency divided by N. This single output has TTL drive capability. The down-counter is preset by means of 16 jam inputs.

The three Mode-Select Inputs Ka, Kb, and Kc determine the modulus ("divide-by" number) of the first and last counting sections in accordance with the truth table shown in Table I. Every time the first (fastest) counting section goes through one cycle, it reduces by 1 the number that has been preset (jammed) into the three decades of the intermediate counting section and into the last counting section, which consists of flip-flops that are not needed for operating the first counting section. For example, in the ÷ 2 mode, only one flip-flop is needed in the first counting section. Therefore the last counting section has three flip-flops that can be preset to a maximum count of seven with a place value of thousands. If ÷ 10 is desired for the first section, Ka is set to 1, Kb to 1, and Kc to 0. Jam Inputs J1, J2, J3, and J4 are used to preset the first counting section and there is no last counting section. The intermediate counting section consists of three cascaded BCD decade (÷ 10) counters presettable by means of Jam Inputs J5 through J16.

The Mode-Select Inputs permit frequency-synthesizer channel separations of 10, 12.5, 20, 25, or 50 parts. These inputs set the maximum value of N at 9999 (when the first counting section divides by 5 or 10) or 15,999 (when the first counting section divides by 8, 4, or 2).

The three decades of the intermediate counting section can be preset to a binary 15 instead of a binary 9, while their place values are still 1, 10, and 100, multiplied by the number of the ÷ N mode. For example, in the ÷ 8 mode, the number from which counting-down begins can be preset to:

3rd decade:	1500
2nd decade:	150
1st decade:	15
Last counting section	1000

The total of these numbers (2665) times 8 equals 21,320. The first counting section can be preset to 7. Therefore, 21,327 is the maximum possible count in the ÷ 8 mode.

The highest count of the various modes is shown in the column entitled Extended

Counter Range of Table 1. Control inputs Kb and Kc can be used to initiate and lock the counter in the "master preset" state. In this condition the flip-flops in the counter are preset in accordance with the jam inputs and the counter remains in that state as long as Kb and Kc both remain low. The counter begins to count down from the preset state when a counting mode other than the master preset mode is selected.

The counter should always be put in the master preset mode before the ÷ 5 mode is selected.

Whenever the master preset mode is used, control signals Kb=0 and Kc=0 must be applied for at least 3 full clock pulses.

After the Master Preset Mode inputs have been changed to one of the ÷ modes, the next positive-going clock transition changes an internal flip-flop so that the countdown can begin at the second positive-going clock transition. Thus, after an MP (Master Preset) mode, there is always one extra count before the output goes high. Fig. 1 illustrates a total count of 3 (÷ 8 mode). If the Master Preset mode is started two clock cycles or less before an output pulse, the output pulse will appear at the time due. If the Master Preset Mode is not used the counter jumps back to the "JAM" count when the output pulse appears.

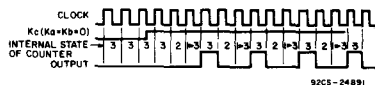
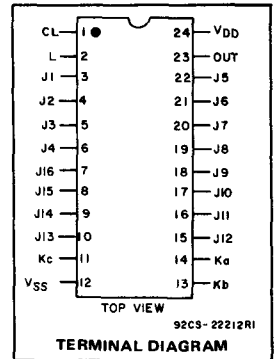

Fig. 1 - Total count of 3.

A "1" on the Latch Enable input will cause the counter output to remain high once an output pulse occurs, and to remain in the high state until the latch input returns to "0". If the Latch Enable is "0", the output pulse will remain high for only 1 cycle of the clock-input signal.

As illustrated in the sample applications, this device is particularly advantageous in communication digital frequency synthesis (VHF, UHF, FM, AM, etc.) where programmable divide-by-"N" counters are an integral part of the synthesizer phase-locked-loop subsystem. The CD4059A can also be used to perform the synthesizer "Fixed Divide-by-R" counting function. It is also useful in general-purpose counters for instrumentation functions such as totalizers, production counters, and "time out" timers.



### Operational and Performance Features:

- Synchronous Programmable ÷ N Counter: N = 3 to 9999 or 15,999
- Presettable down-counter
- Fully static operation
- Mode-select control of initial decade counting function (÷ 10,8,5,4,2)
- T<sup>2</sup>L drive capability
- Master preset initialization
- Latchable ÷ N output
- Quiescent current specified to 15 volts
- Max. input leakage current of 1 µA at 15 volts, full package-temperature range
- 1 volt noise margin, full package-temperature range
- 5-V and 10-V parametric ratings

### Applications

- Communications digital frequency synthesizers: VHF, UHF, FM, AM, etc.
- Fixed or programmable frequency division
- "Time out" timer for consumer-application industrial controls
- Companion Application Note, ICAN-6374, "Application of the CMOS CD4059A Programmable Divide-by-N Counter in FM and Citizens Band Transceiver Digital Tuners"

The CD4059A series types are available in a 24-lead ceramic dual-in-line package (D and F suffixes), 24-lead dual-in-line plastic package (E suffix), 24-lead ceramic flat package (K suffix), and in chip form (H suffix).

# CD4059A Types

## MAXIMUM RATINGS, Absolute-Maximum Values:

DC SUPPLY-VOLTAGE RANGE, (V <sub>DD</sub> )	-0.5 to +15 V
(Voltages referenced to V <sub>SS</sub> Terminal)	
INPUT VOLTAGE RANGE, ALL INPUTS	-0.5 to V <sub>DD</sub> +0.5 V
POWER DISSIPATION PER PACKAGE (P <sub>D</sub> ):	
For T <sub>A</sub> = -40 to +60°C (PACKAGE TYPE E)	500 mW
For T <sub>A</sub> = +60 to +85°C (PACKAGE TYPE E)	Derate Linearly to 200 mW
For T <sub>A</sub> = -55 to +100°C (PACKAGE TYPES D, K, H)	500 mW
For T <sub>A</sub> = +100 to +125°C (PACKAGE TYPES D, K, H)	Derate Linearly to 100 mW
DEVICE DISSIPATION PER OUTPUT TRANSISTOR	
For T <sub>A</sub> = FULL PACKAGE-TEMPERATURE RANGE (All Package Types)	100 mW
OPERATING-TEMPERATURE RANGE (T <sub>A</sub> ):	
PACKAGE TYPES D, K, H	-55 to +125°C
PACKAGE TYPE E	-40 to +85°C
STORAGE TEMPERATURE RANGE (T <sub>stg</sub> )	-65 to +150°C
LEAD TEMPERATURE (DURING SOLDERING):	
At distance 1/16 ± 1/32 inch (1.59 ± 0.79 mm) from case for 10 s max.	+265°C

## OPERATING CONDITIONS AT T<sub>A</sub> = 25°C (Unless otherwise specified)

For maximum reliability, nominal operating conditions should be selected so that operation is always within the following ranges.

Characteristic	V <sub>DD</sub>	Min.	Max.	Units
Supply Voltage Range (over full temp. range)	-	3	12	V
Clock Pulse Width	5	200	-	ns
Clock Input Frequency	5	-	1.5	MHz
	10	-	3	
Clock Input Rise and Fall Time	5	-	15	μs
	10	-	5	

## STATIC ELECTRICAL CHARACTERISTICS

Characteristic	Conditions			Limits								Units
	V <sub>O</sub> (V)	V <sub>IN</sub> (V)	V <sub>DD</sub> (V)	Values at -55°C, +25°C, +125°C Apply to D, K, H Packages				Values at -40°C, +25°C, +85°C Apply to E Packages				
				-55°	-40°	+85°	+125°	+25°				
Quiescent Device Current, I <sub>L</sub> Max.			5	10	10	700	300	-	0.02	10		μA
			10	20	20	200	400	-	0.02	20		
			15	-	-	-	-	-	-	-	500	
Output Voltage:												
Low Level, V <sub>OL</sub> Max.	0,5	5			0,05				0	0,05		V
High Level, V <sub>OH</sub> Min.	0,5	5			4,95			4,95	5	-		
	0,10	10			9,95			9,95	10	-		
Noise Immunity:												
Inputs Low, V <sub>NL</sub> Min.		5			1,5			1,5	2,25	-		V
Inputs High, V <sub>NH</sub> Min.		10			3			3	4,5	-		
Noise Margin:												
Inputs Low, V <sub>NML</sub> Min.	4,5	5					1					V
Inputs High, V <sub>NMH</sub> Min.	9	10					1					
	0,5	5					1					
	1	10					1					
Output Drive Current:												
N-Channel (Sink) I <sub>DN</sub> Min.	0,4	5	2,5	2,3	1,6	1,4	2	4	-			mA
	0,5	10	5	4,7	3,3	2,8	4	9	-			
P-Channel (Source) I <sub>DP</sub> Min.	2,5	5	-2	-1,8	-1,3	-1,15	-1,6	-3,2	-			
	4,6	5	-0,5	-0,45	-0,36	-0,3	-0,4	-0,8	-			
	9,5	10	-1,1	-1	-0,75	-0,65	-0,9	-1,8	-			
Input Leakage Current: I <sub>IL</sub> , I <sub>IH</sub> Max.		15			±1			±10 <sup>-5</sup>	±1			μA

\* Any Input

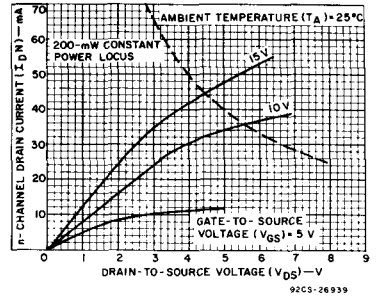

Fig. 2 - Minimum output n-channel drain characteristics.

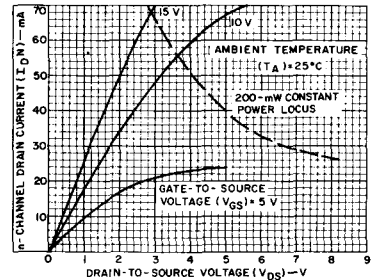

Fig. 3 - Typical output n-channel drain characteristics.

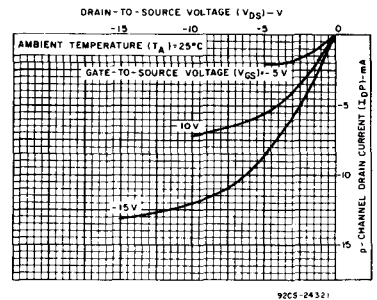

Fig. 4 - Minimum output p-channel drain characteristics.

# CD4059A Types

DYNAMIC ELECTRICAL CHARACTERISTICS AT  $T_A = 25^\circ\text{C}$ ,  $C_L = 50\text{ pF}$ , Input  $t_r, t_f = 20\text{ ns}$ ,  $R_L = 200\text{ k}\Omega$

CHARACTERISTIC	CONDITIONS VDD (V)	LIMITS ALL PACKAGES			UNITS
		Min.	Typ.	Max.	
Propagation Delay Time; $t_{PHL}$ , $t_{PLH}$	5	—	180	360	ns
	10	—	90	180	
Transition Time:	$t_{THL}$	5	—	35	ns
		10	—	20	
	$t_{TLH}$	5	—	100	
		10	—	50	
Maximum Clock Input Frequency, $f_{CL}$	5	1.5	3	MHz	
	10	3	6		
Average Input Capacitance, $C_i$ (any input)	—	—	5	—	pF

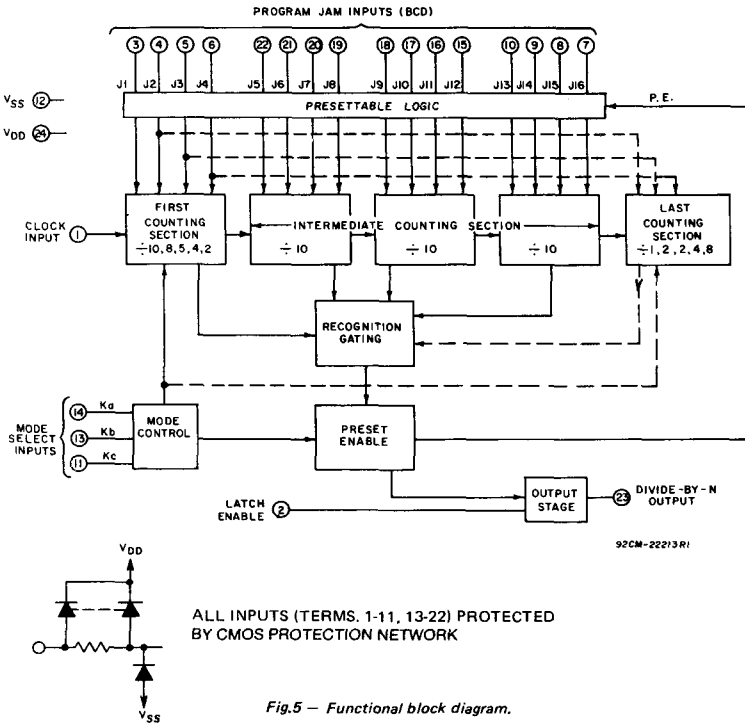

Fig.5 - Functional block diagram.

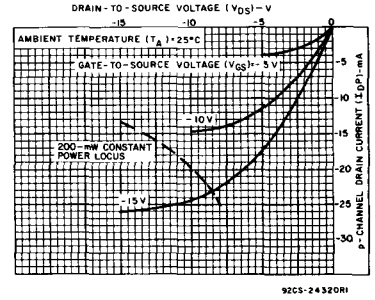

Fig.6 - Typical output p-channel drain characteristics.

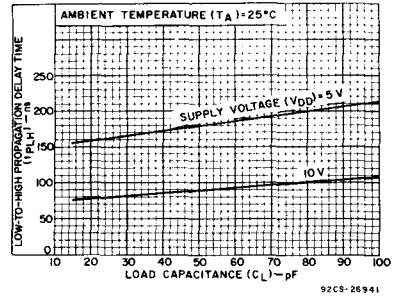

Fig.7 - Typical low-to-high propagation delay time vs. load capacitance.

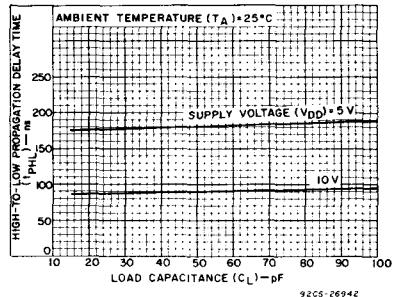

Fig.8 - Typical high-to-low propagation delay time vs. load capacitance.

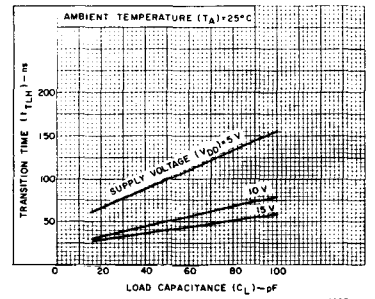

Fig.9 - Typical low-to-high transition time vs. load capacitance.

# CD4059A Types

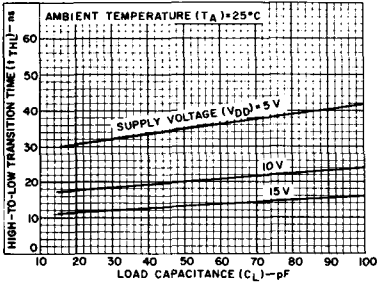

Fig. 10 - Typical high-to-low transition time vs. load capacitance.

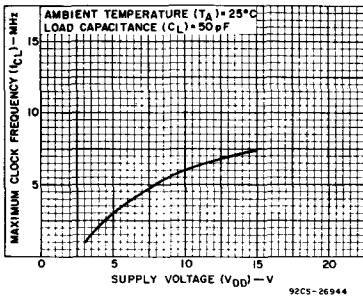

Fig. 11 - Typical max. clock frequency vs. supply voltage.

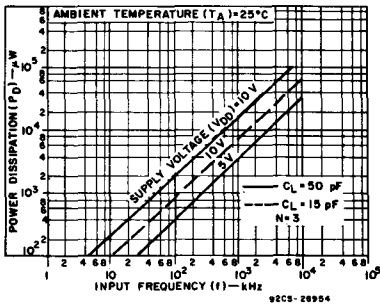

Fig. 12 - Typical power dissipation vs. input frequency.

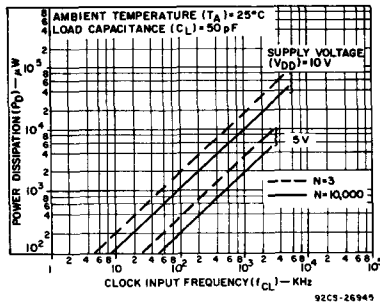

Fig. 13 - Typical power dissipation vs. clock input frequency.

TABLE I

MODE SELECT INPUT			FIRST COUNTING SECTION			LAST COUNTING SECTION			COUNTER RANGE	
Ka	Kb	Kc	MODE	Can be preset to a max of:	Jam <sup>▲</sup> inputs used:	MODE	Can be preset to a max of:	Jam <sup>▲</sup> inputs used:	DESIGN	EXTENDED
			Divides by:			Divides by:		Max.	Max.	
1	1	1	2	1	J1	8	7	J2,J3,J4	15,999	17,331
0	1	1	4	3	J1,J2	4	3	J3,J4	15,999	18,663
1	0	1	5#	4	J1,J2,J3	2	1	J4	9,999	13,329
0	0	1	8	7	J1,J2,J3	2	1	J4	15,999	21,327
1	1	0	10	9	J1,J2,J3,J4	1	0	-	9,999	16,659
X	0	0	MASTER PRESET			MASTER PRESET			-	-

X = Don't Care

▲ J1 = Least significant bit.

J4 = Most significant bit.

# Operation in the ÷5 mode (1<sup>st</sup> counting section) requires going through the Master Preset mode prior to going into the ÷5 mode. At power turn-on, kc must be a logic "0" for a period of 3 input clock pulses after V<sub>DD</sub> reaches a minimum of 3 volts. See Fig. 21 for a suggested external preset circuit.

## HOW TO PRESET THE CD4059A TO DESIRED ÷ N

The value N is determined as follows:

$$N = [\text{MODE}^*] [1000 \times \text{Decade 5 Preset} + 100 \times \text{Decade 4 Preset} + 10 \times \text{Decade 3 Preset} + 1 \times \text{Decade 2 Preset}] + \text{Decade 1 Preset} \quad (1)$$

\* MODE = First counting section divider (10, 8, 5, 4 or 2)

To calculate preset values for any N count, divide the N count by the Mode.

The resultant is the corresponding preset values of the 5th through 2nd decade with the remainder being equal to the 1st decade value.

$$\text{Preset Value} = \frac{N}{\text{Mode}} \quad (2)$$

Examples:

A) N = 8479, Mode = 5

MODE SELECT = 5

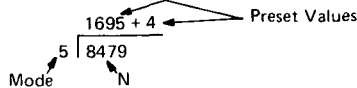

Ka Kb Kc  
1 0 1

### PROGRAM JAM INPUTS (BCD)

4				1				5				9				6			
J1	J2	J3	J4	J5	J6	J7	J8	J9	J10	J11	J12	J13	J14	J15	J16				
0	0	1	1	1	0	1	0	1	0	0	1	0	1	1	0				

To verify the results use equation 1:

$$N = 5 (1000 \times 1 + 100 \times 6 + 10 \times 9 + 1 \times 5) + 4$$

$$N = 8479$$

MODE SELECT = 8

B) N = 12382, Mode = 8

$$8 \overline{) 12382} \\ \underline{8} \phantom{0000} \\ 4382 \\ \underline{4000} \\ 382 \\ \underline{320} \\ 62 \\ \underline{64} \\ -2$$

Ka Kb Kc  
0 0 1

PROGRAM JAM INPUTS

6				1				7				4				5			
J1	J2	J3	J4	J5	J6	J7	J8	J9	J10	J11	J12	J13	J14	J15	J16				
0	1	1	1	1	1	1	0	0	0	1	0	1	0	1	0				

To verify:  
 $N = 8 (1000 \times 1 + 100 \times 5 + 10 \times 4 + 1 \times 7) + 6$   
 $N = 12382$

C)  $N = 8479$ , Mode = 10

$$10 \overline{) 08479}$$

MODE SELECT = 10

Ka Kb Kc  
1 1 0

PROGRAM JAM INPUTS

9				7				4				8			
J1	J2	J3	J4	J5	J6	J7	J8	J9	J10	J11	J12	J13	J14	J15	J16
1	0	0	1	1	1	1	0	0	0	1	0	0	0	0	1

To Verify:  
 $N = 10 (1000 \times 0 + 100 \times 8 + 10 \times 4 + 1 \times 7) + 9$   
 $N = 8479$

## DIGITAL PHASE-LOCKED LOOP (PLL) FOR FM BAND SYNTHESIZER

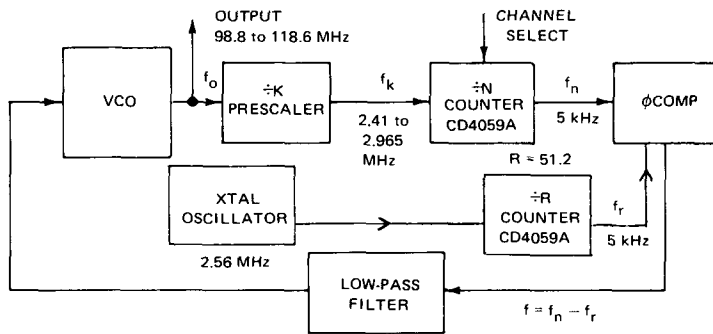

### 1) Calculating Min & Max "N" Values :

Output Freq. Range ( $f_o$ ) = 98.8 to 118.6 MHz

Channel Spacing Freq. ( $f_c$ ) = 200 kHz

Division Factor ( $k$ ) = 40

Reference Freq. ( $f_r$ ) =  $\frac{f_c}{k} = \frac{200}{40}$  kHz = 5 kHz

$$f_k = \frac{f_o}{40} : f_{kMax} = \frac{118.6 \text{ MHz}}{40} = 2.965 \text{ MHz}; f_{kMin} = \frac{98.8 \text{ MHz}}{40} = 2.47 \text{ MHz}$$

$$N = \frac{f_o}{f_c}$$

$$N_{Max} = \frac{118.6 \text{ MHz}}{200 \text{ kHz}} = 593 \quad N_{Min} = \frac{98.8 \text{ MHz}}{200 \text{ kHz}} = 494 \quad R = \frac{2.56 \text{ MHz}}{5 \text{ kHz}} = 512$$

## "CASCADING" VIA OTHER COUNTERS

Fig. 14 shows a BCD-switch compatible arrangement suitable for  $\div 8$  and  $\div 5$  modes, which can be adapted, with slight changes, to the other divide-by-modes. In order to be able to preset to any number from three to about 256,000, while preserving the BCD-switch compatible character of the jam inputs, a rather complex cascading scheme is required. Such a cascading scheme is necessary because the CD4059A can never be preset to a count less than 3 and logic is needed to detect the condition that one of the numbers to be preset in the CD4059A is rather small. In order to simplify the detection logic, only that condition is detected where the jam inputs to terminals 6, 7, and 9 would be low during one count. If such a condition is detected, and if at least 1 is expected to be jammed into the MSB counter, the detection logic removes one from the number to be jammed into the MSB counter (with a place value of 2000 times the divide-by-mode) and jams the same 2000 into the CD4059A by forcing terminals 6, 7, and 9 high.

The clock of the CD4013A may be driven directly from the output of the CD4059A, as shown by dashed option (1), or by the inverted output of the CD4059A, option (2). If option (2) is used the CD4029A cannot count cycles shorter than 3. If option (1) is used propagation delay problems may occur at high counting speeds.

The general circuit in Fig. 14 can be simplified considerably if the range of the cascaded counters does not have to start at a very low value. Fig. 15 shows an arrangement in the  $\div 4$  mode, where the counting range extends in a BCD-switch compatible manner from 88,003 to 103,999. The arrangement shown in Fig. 15 is easy to follow; once during each cycle, the less significant digits are jammed in (14,712 in this case) and then 11,000 ( $4 \times 2750$ ) is jammed in eight times in succession, by forcing jam inputs high or low, as required.

Numbers larger than the extended counter range can also be produced by cascading the CD4059A with some other counting device. Fig. 16 shows such an arrangement where only one fixed divide-by number is desired which is close to three times the extended counter range as shown in the last column of Table I. The dual flip-flop wired to produce a  $\div 3$  count, can be replaced by other counters such as the CD4029, CD4510, CD4516, CD4017, or the CD4022. In Fig. 16 the  $\div N$  subsystem is preset once to a number smaller than the desired divide-by number. This smaller number represents the less significant digits of the divide-by number. The subsystem is then preset one or more times to a round number (e.g. 1000, 2000) and multiplied by the number of the divide-by mode ( $\div 2$  in the example of Fig. 16). It is important that the second counting device has an output that is high or low, as the case may be, during only one of its counting states.

# CD4059A Types

2)  $\div N$  Counter Configuration for UHF – 220 to 400 MHz  
 Channel Spacing: 50 kHz or 25 kHz

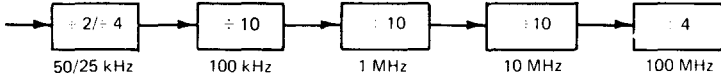

$$N_{Max} = \frac{400 \text{ MHz}}{25 \text{ kHz}} = 16,000 \quad N_{Max} = \frac{400 \text{ MHz}}{50 \text{ kHz}} = 8,000$$

$$N_{Min} = \frac{220 \text{ MHz}}{25 \text{ kHz}} = 8,800 \quad N_{Min} = \frac{220 \text{ MHz}}{50 \text{ kHz}} = 4,400$$

3)  $\div N$  Counter Configuration to VHF – 116 MHz  
 Channel Spacing = 12.5 kHz

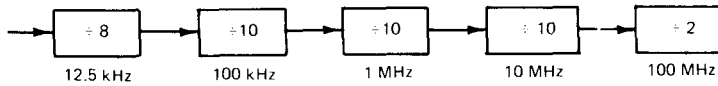

$$N_{Max} = \frac{160 \text{ MHz}}{12.5 \text{ kHz}} = 12,800 \quad N_{Min} = \frac{116 \text{ MHz}}{12.5 \text{ kHz}} = 9,300$$

4)  $\div N$  Counter Configuration for VHF – 30 to 80 MHz  
 Channel Spacing: 25 kHz

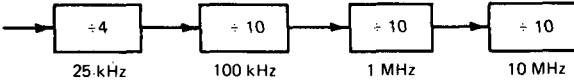

$$N_{Max} = \frac{80 \text{ MHz}}{25 \text{ kHz}} = 3,200 \quad N_{Min} = \frac{30 \text{ MHz}}{25 \text{ kHz}} = 1,200$$

5)  $\div N$  Counter Configuration for AM – 995 to 2055 kHz  
 Channel Spacing = 10 kHz

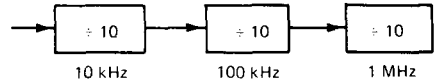

$$N_{Max} = \frac{2055 \text{ kHz}}{10 \text{ kHz}} = 205 \quad N_{Min} = \frac{995 \text{ kHz}}{10 \text{ kHz}} = 99$$

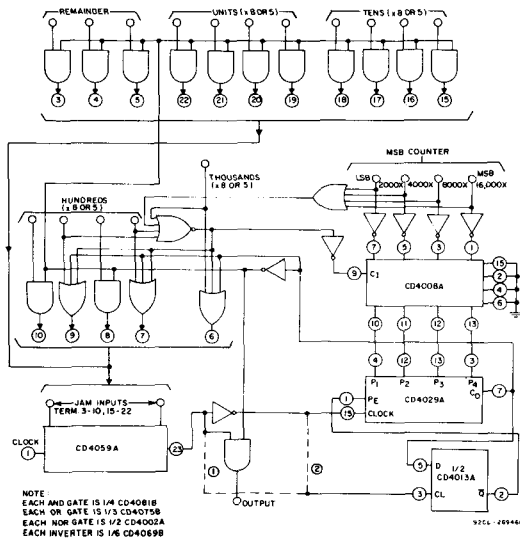

Fig.14 – BCD switch-compatible  $\div N$  system of the most general kind.



# CD4059A Types

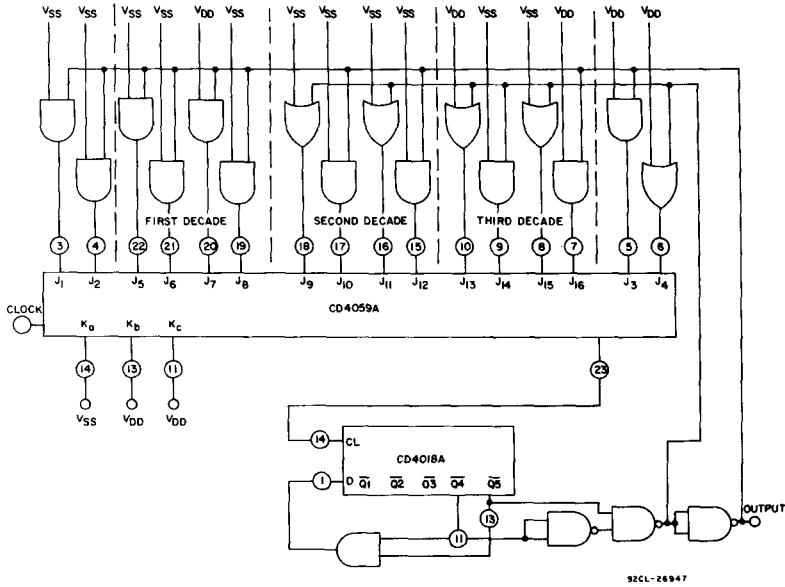

Fig. 15 - Dividing by any number from 88,003 to 103,999.

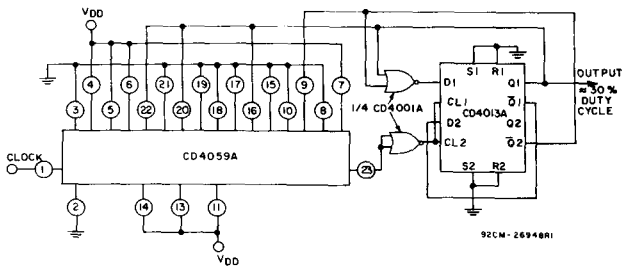

Fig. 16 - Division by 47,690 in  $\div 2$  mode.

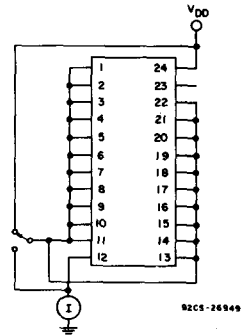

Fig. 17 - Quiescent device current test circuit.

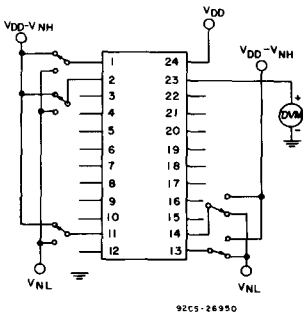

Fig. 18 - Noise immunity test circuit.

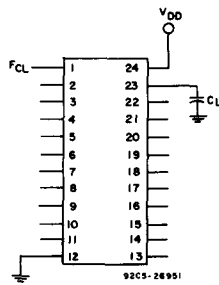

Fig. 19 - Power dissipation test circuit (all  $\div$  modes).

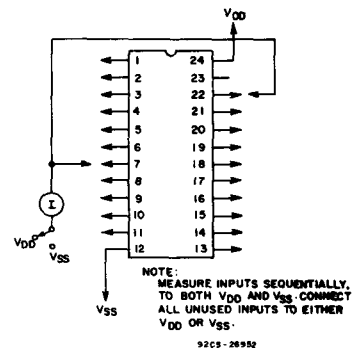
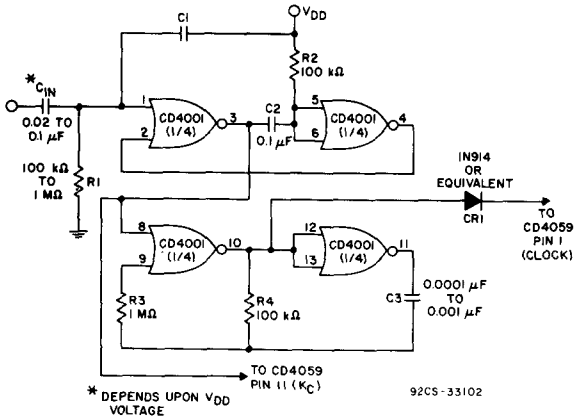

Fig. 20 - Input leakage current test circuit.

# CD4059A Types



For changing from any mode other than mode 5 (with power on), apply positive pulse to  $C_{in}$ . This circuit automatically selects master preset mode ( $K_b = 0, K_c = 0$ ) before going into the select conditions for mode 5 ( $K_a = 1, K_b = 0, K_c = 1$ ). The selection of  $C_1$  and  $C_2$  is critical.  $C_1$  is determined by the  $V_{DD}$  voltage—the lower  $V_{DD}$ 's need larger  $C_1$ 's.  $C_2$  must be 0.1  $\mu F$  or larger.

Fig.21 - CD4059A mode 5 power on master preset circuit.

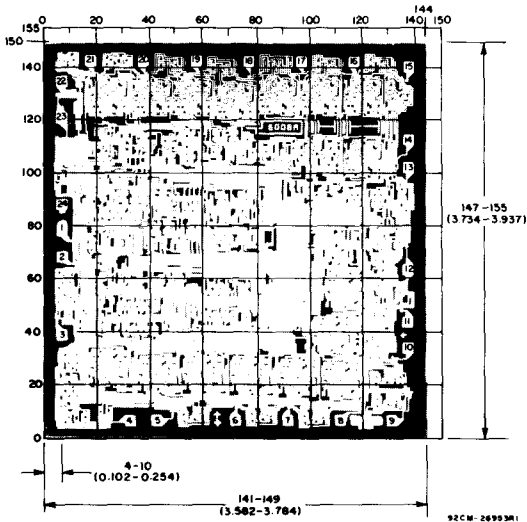

The photographs and dimensions of each CMOS chip represent a chip when it is part of the wafer. When the wafer is separated into individual chips, the angle of cleavage may vary with respect to the chip face for different chips. The actual dimensions of the isolated chip, therefore, may differ slightly from the nominal dimensions shown. The user should consider a tolerance of  $-3$  mils to  $+16$  mils applicable to the nominal dimensions shown.

Dimensions in parentheses are in millimeters and are derived from the basic inch dimensions as indicated. Grid graduations are in mils ( $10^{-3}$  inch).

Dimensions and pad layout for CD4059AH.

# CMOS 14-Stage Ripple-Carry Binary Counter/Divider and Oscillator

The RCA-CD4060A consists of an oscillator section and 14 ripple-carry binary counter stages. The oscillator configuration allows design of either RC or crystal oscillator circuits. A RESET input is provided which resets the counter to the all-0's state and disables the oscillator. A high level on the RESET line accomplishes the reset function. All counter stages are master-slave flip-flops. The state of the counter is advanced one step in binary order on the negative transition of  $\phi_1(\phi_Q)$ . All inputs and outputs are fully buffered.

These types are supplied in 16-lead hermetic dual-in-line ceramic packages (D and F suffixes), 16-lead dual-in-line plastic package (E suffix), 16-lead ceramic flat packages (K suffix), and in chip form (H suffix).

**Features:**

- 4-MHz operating frequency (typ.) at  $V_{DD} - V_{SS} = 10\text{ V}$
- Common reset
- Fully static operation
- 10 buffered outputs available
- Quiescent current specified to 15 V
- Maximum input leakage current of  $1\ \mu\text{A}$  at 15 V (full package-temperature range)
- 1-V noise margin (full package-temperature range)

**Oscillator Features:**

- All active components on chip
- RC or crystal oscillator configuration

**Applications:**

- Timers
- Frequency dividers

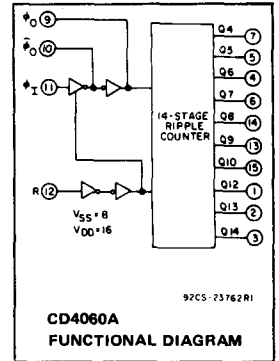

**MAXIMUM RATINGS, Absolute-Maximum Values:**

STORAGE TEMPERATURE RANGE ( $T_{stg}$ )	.....	-65 to +150°C
OPERATING-TEMPERATURE RANGE ( $T_A$ ):		
PACKAGE TYPES D, F, K, H	.....	-55 to +125°C
PACKAGE TYPE E	.....	-40 to +85°C
DC SUPPLY-VOLTAGE RANGE, ( $V_{DD}$ )		
(Voltages referenced to $V_{SS}$ Terminal)	.....	-0.5 to +15 V
POWER DISSIPATION PER PACKAGE ( $P_D$ ):		
For $T_A = -40$ to $+60^\circ\text{C}$ (PACKAGE TYPE E)	.....	500 mW
For $T_A = +60$ to $+85^\circ\text{C}$ (PACKAGE TYPE E)	.....	Derate Linearly at 12 mW/ $^\circ\text{C}$ to 200 mW
For $T_A = -55$ to $+100^\circ\text{C}$ (PACKAGE TYPES D, F, K)	.....	500 mW
For $T_A = +100$ to $+125^\circ\text{C}$ (PACKAGE TYPES D, F, K)	.....	Derate Linearly at 12 mW/ $^\circ\text{C}$ to 200 mW
DEVICE DISSIPATION PER OUTPUT TRANSISTOR		
For $T_A = \text{FULL PACKAGE-TEMPERATURE RANGE (All Package Types)}$	.....	100 mW
INPUT VOLTAGE RANGE, ALL INPUTS	.....	-0.5 to $V_{DD} + 0.5\text{ V}$
LEAD TEMPERATURE (DURING SOLDERING):		
At distance $1/16 \pm 1/32$ inch ( $1.59 \pm 0.79\text{ mm}$ ) from case for 10 s max.	.....	+265°C

**RECOMMENDED OPERATING CONDITIONS at  $T_A = 25^\circ\text{C}$ , Except as Noted.**  
For maximum reliability, nominal operating conditions should be selected so that operation is always within the following ranges:

CHARACTERISTIC	$V_{DD}$ (V)	LIMITS				UNITS
		D, F, K, H Packages		E Package		
		Min.	Max.	Min.	Max.	
Supply-Voltage Range (For $T_A = \text{Full Package-Temperature Range}$ )		3	12	3	12	V
Input-Pulse Width, $t_W$ $f = 100\text{ kHz}$	5 10	400 110	—	500 125	—	ns
Input-Pulse Rise & Fall Time, $t_{r\phi}$ , $t_{f\phi}$	5 10	—	15 7.5	—	15 7.5	$\mu\text{s}$
Input-Pulse Frequency, $f_\phi$	5 10	—	1 3	—	0.9 2.75	MHz
Reset Pulse Width, $t_W$	5 10	1000 500	—	1250 600	—	ns

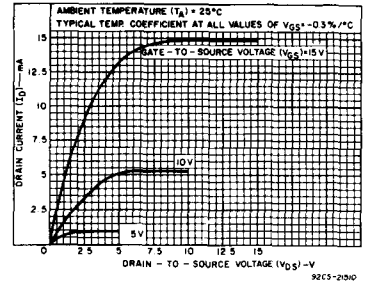

Fig. 1 — Typical n-channel drain characteristics.

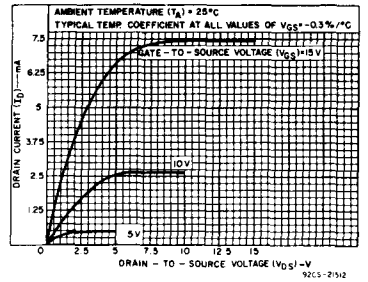

Fig. 2 — Minimum n-channel drain characteristics.

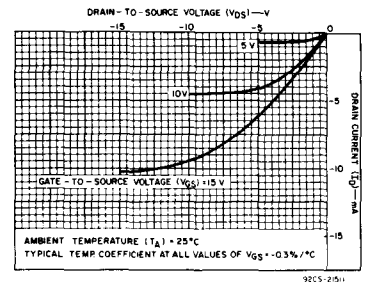

Fig. 3 — Typical p-channel drain characteristics.

# CD4060A Types

## STATIC ELECTRICAL CHARACTERISTICS

Characteristic	Conditions			Limits at Indicated Temperatures (°C)								Units
	V <sub>O</sub> (V)	V <sub>IN</sub> (V)	V <sub>DD</sub> (V)	D, F, K, H Packages				E Package				
				-55	+25		+125	-40	+25		+85	
				Typ.	Limit	Typ.	Limit	Typ.	Limit	Typ.	Limit	
Quiescent Device Current I <sub>L</sub> Max.	-	-	5	15	0.5	15	900	50	1	50	700	μA
	-	-	10	25	1	25	1500	100	2	100	1400	
	-	-	15	50	2.5	50	2000	500	5	500	5000	
Output Voltage: Low Level, V <sub>OL</sub>	-	5	5	0 Typ.; 0.05 Max.								V
	-	10	10	0 Typ.; 0.05 Max.								
High Level V <sub>OH</sub>	-	0	5	4.95 Min.; 5 Typ.								V
	-	0	10	9.95 Min.; 10 Typ.								
Noise Immunity: Inputs Low, V <sub>NL</sub>	4.2	-	5	1.5 Min.; 2.25 Typ.								V
	9	-	10	3 Min.; 4.5 Typ.								
Inputs High V <sub>NH</sub>	0.8	-	5	1.5 Min.; 2.25 Typ.								V
	10	-	10	3 Min.; 4.5 Typ.								
Noise Margin: Inputs Low, V <sub>NML</sub>	4.5	-	5	1 Min.								V
	9	-	10	1 Min.								
Inputs High, V <sub>NMH</sub>	0.5	-	5	1 Min.								V
	1	-	10	1 Min.								
Output Drive Current: * n-Channel (Sink), I <sub>DN</sub> Min.	0.5	-	5	0.22	0.36	0.18	0.125	0.21	0.36	0.18	0.15	mA
	0.5	-	10	0.44	0.75	0.36	0.25	0.42	0.75	0.36	0.3	
p-Channel (Source), I <sub>DP</sub> Min.	4.5	-	5	-0.15	-0.25	-0.125	-0.085	-0.145	-0.25	-0.125	-0.1	mA
	9.5	-	10	-0.3	-0.5	-0.25	-0.175	-0.29	-0.5	-0.25	-0.2	
Input Leakage Current, I <sub>IL</sub> , I <sub>IH</sub>	Any Input			±10 <sup>-5</sup> Typ., ±1 Max.								μA
	-	-	15									

\* Data not applicable to Terminal 9 or 10

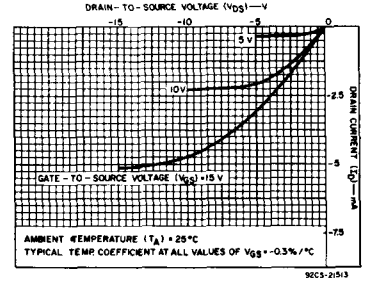

Fig. 4 - Minimum p-channel drain characteristics.

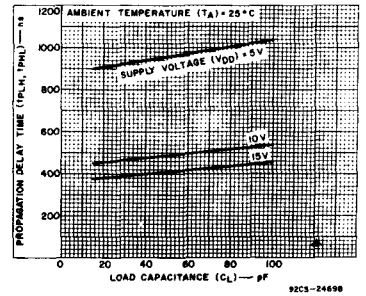

Fig. 5 - Typical propagation delay time vs. load capacitance (Q<sub>4</sub> output).

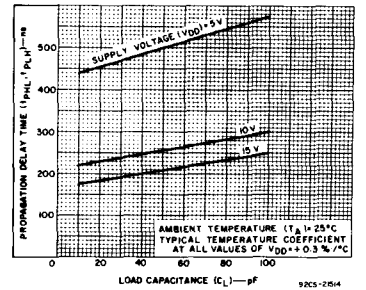

Fig. 6 - Typical propagation delay time vs. load capacitance (Q<sub>n</sub> to Q<sub>n+1</sub>).

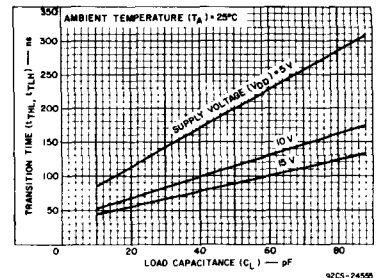

Fig. 8 - Typical output transition time vs. load capacitance.

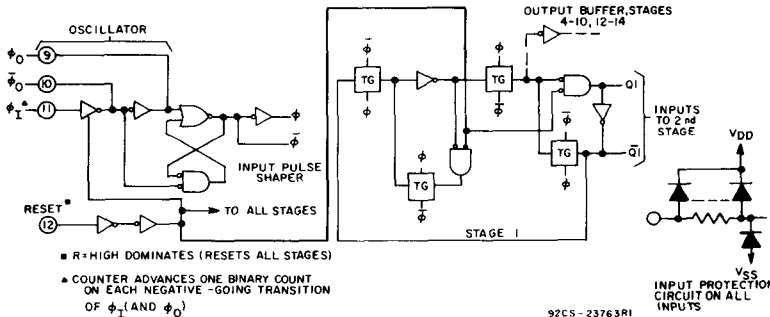

Fig. 7 - Logic diagram of CD4060A oscillator, pulse shaper, and 1 of 14 counter stages.

# CD4060A Types

DYNAMIC ELECTRICAL CHARACTERISTICS at  $T_A = 25^\circ\text{C}$ , Input  $t_r, t_f = 20\text{ ns}$ ,  
 $C_L = 15\text{ pF}, R_L = 200\text{ k}\Omega$

CHARACTERISTIC	TEST CONDITIONS	LIMITS						UNITS	
		D, F, K, H Packages			E Package				
		$V_{DD}$ (V)	Min.	Typ.	Max.	Min.	Typ.		Max.
<b>Input-Pulse Operation</b>									
Propagation Delay Time, $\phi_1$ to Q4 Out; $t_{PHL}, t_{PLH}$		5	-	900	1800	-	900	1900	ns
		10	-	450	900	-	450	950	
Propagation Delay Time, $Q_n$ to $Q_{n+1}$ ; $t_{PHL}, t_{PLH}$		5	-	450	900	-	450	950	ns
		10	-	225	450	-	225	475	
Transition Time, $t_{THL}, t_{TLH}$		5	-	150	300	-	150	350	ns
		10	-	75	150	-	75	175	
Min. Input-Pulse Width $t_W$	f=100 kHz	5	-	200	400	-	200	500	ns
		10	-	75	110	-	75	125	
Input-Pulse Rise & Fall Time, $t_{r\phi}, t_{f\phi}$		5	-	-	15	-	-	15	$\mu\text{s}$
		10	-	-	7.5	-	-	7.5	
Max. Input-Pulse Frequency, $f_\phi$		5	1	1.75	-	0.9	1.75	-	MHz
		10	3	4	-	2.75	4	-	
Input Capacitance, $C_i$	Any Input	-	5	-	-	5	-	pF	
<b>Reset Operation</b>									
Propagation Delay Time, $t_{PHL}$		5	-	500	1000	-	500	1250	ns
		10	-	250	500	-	250	600	
Minimum Reset Pulse Width, $t_W$		5	-	500	1000	-	500	1250	ns
		10	-	250	500	-	250	600	

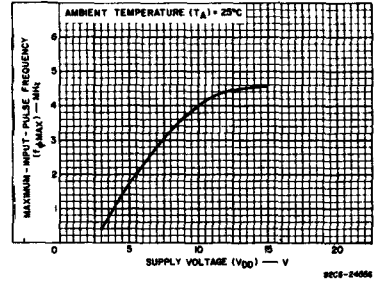

Fig. 9 - Typical maximum-input-pulse frequency vs. supply voltage.

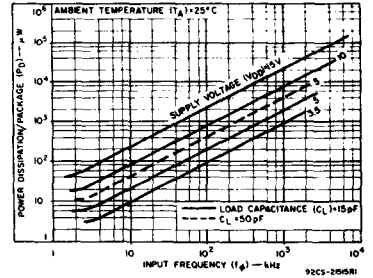

Fig. 10 - Typical dynamic power dissipation characteristics.

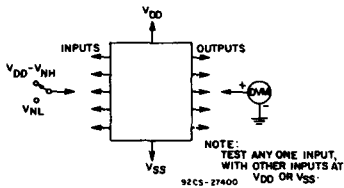

Fig. 12 - Noise-immunity test circuit.

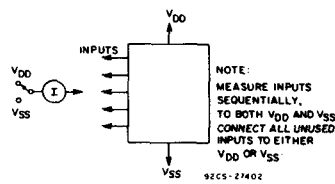

Fig. 13 - Input-leakage-current test circuit.

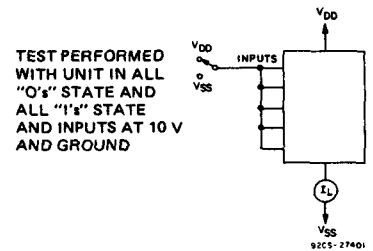

Fig. 11 - Quiescent-device current test circuit.

# CD4062A Types

## CMOS 200-Stage Dynamic Shift Register

### MAXIMUM RATINGS, Absolute-Maximum Values:

STORAGE TEMPERATURE RANGE ( $T_{stg}$ )	-65 to +150°C
OPERATING-TEMPERATURE RANGE ( $T_A$ ):	
PACKAGE TYPES K, T, H	-55 to +125°C
DC SUPPLY-VOLTAGE RANGE, ( $V_{DD}$ )	
(Voltages referenced to $V_{SS}$ Terminal)	-0.5 to +15 V
POWER DISSIPATION PER PACKAGE ( $P_D$ ):	
For $T_A = -55$ to $+100^\circ\text{C}$ (PACKAGE TYPES K, T)	500 mW
For $T_A = +100$ to $+125^\circ\text{C}$ (PACKAGE TYPES K, T)	Derate Linearly at 12 mW/°C to 200 mW
DEVICE DISSIPATION PER OUTPUT TRANSISTOR	
For $T_A =$ FULL PACKAGE-TEMPERATURE RANGE (All Package Types)	100 mW
INPUT VOLTAGE RANGE, ALL INPUTS	-0.5 to $V_{DD} + 0.5$ V
LEAD TEMPERATURE (DURING SOLDERING):	
At distance $1/16 \pm 1/32$ inch ( $1.59 \pm 0.79$ mm) from case for 10 s max.	+265°C

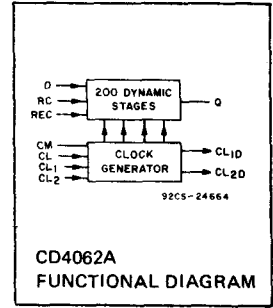

The RCA-CD4062A is a 200-stage dynamic shift register with provision for either single- or two-phase clock input signals. Single-phase-clocked operation is intended for low-power, low clock-line capacitance requirements. Single-phase clocking is specified for medium-speed operation (< 1 MHz) at supply voltages up to 10 volts. Clock input capacitance is extremely low (< 5 pF), and clock rise and fall times are non-critical. The clock-mode signal (CM) must be low for single-phase operation.

Two-phase clock-input signals may be used for high-speed operation (up to 5 MHz) or to further reduce clock rise and fall time requirements at low speeds. Two-phase operation is specified for supply voltages up to 15 volts. Clock input capacitance is only 50 pF/phase. The clock-mode signal (CM) must be high for two-phase operation. The single-phase-clock input has an internal pull-down which is activated when CM is high and may be left unconnected in two-phase operation.

The logic level present at the data input is transferred into the first stage and shifted one stage at each positive-going clock transition for single-phase operation, and at the positive-going transition of CL<sub>1</sub> for two-phase operation.

The CD4062A-Series types are supplied in 12-lead hermetic TO-5 packages (T suffix), 16-lead ceramic flat packages (K suffix), and in chip form (H suffix).

### Features:

- Minimum shift rates over full temperature range—

Single-phase clock:  $3\text{ V} \leq V_{DD} \leq 10\text{ V}$ ;  
 $f_{min} = 10\text{ kHz}$ ;  $-55^\circ\text{C} \leq T_A \leq +125^\circ\text{C}$   
 ( $f_{min} = 1\text{ kHz}$  up to  $T_A \leq 75^\circ\text{C}$ )

Two-phase clock:  $3\text{ V} \leq V_{DD} \leq 15\text{ V}$ ;  
 $f_{min} = 10\text{ kHz}$ ;  $-55^\circ\text{C} \leq T_A \leq +125^\circ\text{C}$   
 ( $f_{min} = 1\text{ kHz}$  up to  $T_A \leq 75^\circ\text{C}$ )

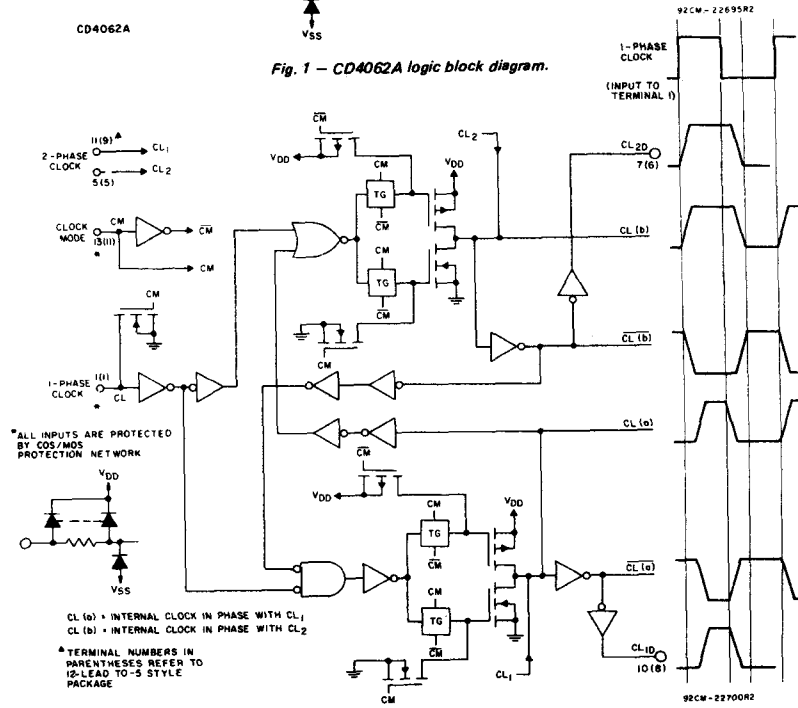
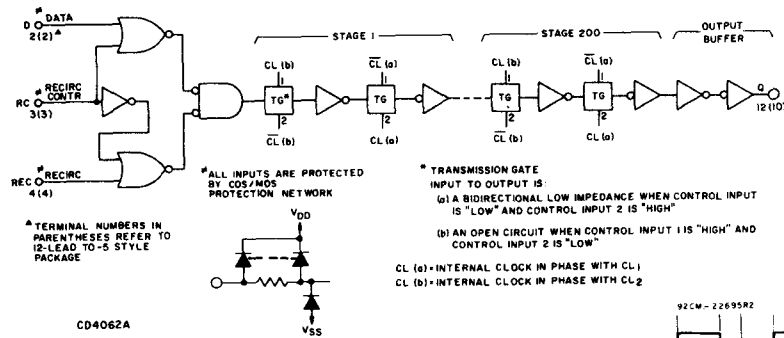

# CD4062A Types

## RECOMMENDED OPERATING CONDITIONS at $T_A = 25^\circ\text{C}$ , Except as Noted.

For maximum reliability, nominal operating conditions should be selected so that operation is always within the following ranges:

CHARACTERISTIC	$V_{DD}$ (V)	LIMITS		UNITS
		MIN.	MAX.	
Supply-Voltage Range (For $T_A =$ Full Package-Temperature Range): Single-Phase Clock Two-Phase Clock		3 3	10 12	V
Clock Input Frequency, $f_{CL}^*$	5 10	0.15 0.15	500 1000	kHz
Clock Pulse Width, $t_W^*$	5 10	250 500	$66.7 \times 10^6$ $66.7 \times 10^6$	ns
Clock Rise or Fall Times, $t_{rCL}$ or $t_{fCL}^*$	5 10	— —	10 1	$\mu\text{s}$
Data Hold Time, $t_H^*$	5 10	150 50	— —	ns

\* For single-phase clock, 50% duty cycle

Two-Phase Clock Operation ( $CL_1, CL_2$ ); Clock Mode (CM) = High;  $3\text{V} \leq V_{DD} \leq 15\text{V}$ . See Figure 4.

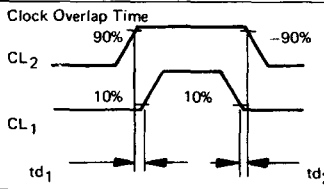
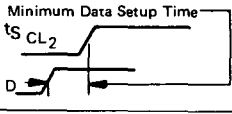
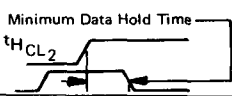
CHARACTERISTIC	TEST CONDITIONS	LIMITS			UNITS	
		$V_{DD}$ V	MIN.	TYP.		MAX.
Maximum Clock Input Frequency, $f_{CL}$		5	1.25	2.5	—	MHz
		10	2.5	5	—	
Minimum Clock Input Frequency, $f_{CL}$		5	150	10	—	Hz
		10	150	10	—	
Clock Overlap Time 			40	—	—	ns
Average Input Capacitance, $C_i$ $CL_1, CL_2$			—	50	—	pF
Propagation Delays: $t_{PHL}, t_{PLH}$ $CL_1$ to Q		5	—	250	500	ns
		10	—	100	200	
		5	—	250	500	
$CL_1$ to $CL_{1D}$ $CL_2$ to $CL_{2D}$		5	—	100	200	ns
		10	—	100	200	
Minimum Data Setup Time 		5	—	150	300	ns
		10	—	50	100	
Minimum Data Hold Time 		5	—	—	0	ns
		10	—	—	0	
Clock Rise and Fall Times $t_{rCL1}, CL_2$ $t_{fCL1}, CL_2$			No Restrictions If Clock Overlap Requirement Is Met			

## Features (Cont'd):

- Low power dissipation  
0.3 mW/bit at 1 MHz and 10 V  
0.04 mW/bit at 0.5 MHz and 5V (alternating 1-0 data pattern)
- Data output TTL-DTL compatible
- Recirculating capability
- Delayed two-phase clock outputs available for cascading registers
- Asynchronous ripple-type presettable to all 1's or 0's
- Ultra-low-power-dissipation standby operation
- Quiescent current specified to 15 V
- Maximum input leakage current of 1  $\mu\text{A}$  at 15 V (full package-temperature range)
- 1-V noise margin (full package-temperature range)

## Applications:

- Serial shift registers
- Time-delay circuits
- CRT refresh memory
- Long serial memory

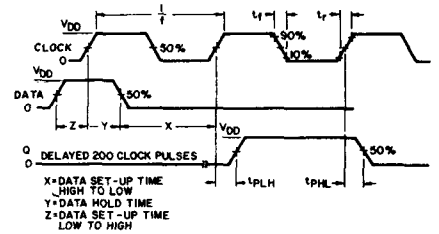

92CS-22702R1

Fig. 3 — Timing diagram—single-phase clock.

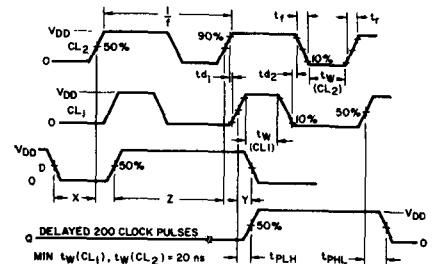

92CS-22703

Fig. 4 — Timing diagram—two-phase clock.

# CD4062A Types

## STATIC ELECTRICAL CHARACTERISTICS

CHARACTERISTICS	CONDITIONS			LIMITS AT INDICATED TEMPERATURES (°C)				UNITS				
	V <sub>O</sub> (V)	V <sub>IN</sub> (V)	V <sub>DD</sub> (V)	-55	+25		+125					
					TYP.	LIMIT						
Quiescent Device Current, I <sub>L</sub> Max. CM=High, CL <sub>1</sub> =High, CL <sub>2</sub> =Low	-	-	5	12	0.5	12	720	μA				
	-	-	10	25	1	25	1500					
	-	-	15	50	1	50	2000					
Output Voltage: Low Level, V <sub>OL</sub>	-	5	5	0 Typ.; 0.05 Max				V				
	-	10	10	0 Typ.; 0.05 Max								
High Level V <sub>OH</sub>	-	0	5	4.95 Min.; 5 Typ.				V				
	-	0	10	9.95 Min.; 10 Typ.								
Noise Immunity: Inputs Low, V <sub>NL</sub>	4.2	-	5	1.5 Min.; 2.25 Typ.				V				
	9	-	10	3 Min.; 4.5 Typ.								
Inputs High V <sub>NH</sub>	0.8	-	5	1.5 Min.; 2.25 Typ.				V				
	1	-	10	3 Min.; 4.5 Typ.								
Noise Margin: Inputs Low, V <sub>NML</sub>	4.5	-	5	1 Min.				V				
	9	-	10	1 Min.								
Inputs High, V <sub>NMH</sub>	0.5	-	5	1 Min.				V				
	1	-	10	1 Min.								
Output Drive Current: N-Channel (Sink), I <sub>DN</sub> Min.	Q	-	4.5	1.6	2.6	1.3	0.91	mA				
				Output	0.5	-	10		5	8*	4	3.2
				CL1D	0.5	-	5		0.87	1.4	0.7	0.49
				CL2D	0.5	-	10		2.2	3.6	1.8	1.26
				P-Channel (Source): I <sub>DP</sub> Min.	Q	4.5	-		5	-0.31	-0.5	-0.25
P-Channel (Source): I <sub>DP</sub> Min.	Q	-	5	-0.93	-1.5	-0.75	-0.52	mA				
				Output	9.5	-	10		-0.87	-1.4	-0.7	-0.49
				CL1D	4.5	-	5		-0.43	-0.7	-0.35	-0.24
				CL2D	9.5	-	10		-1.1	-1.8	-0.9	-0.63
Input Leakage Current, I <sub>IL</sub> , I <sub>IH</sub>	Any Input			±10 <sup>-5</sup> Typ., ±1 Max.				μA				

\* Maximum power dissipation rating ≤ 200 mW.

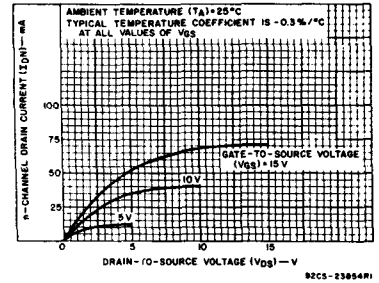

Fig. 5—Typical n-channel drain characteristics for Q output.

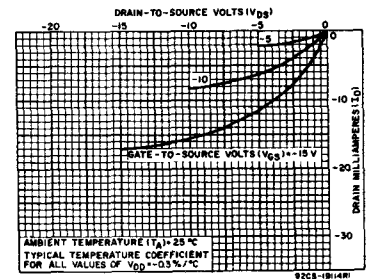
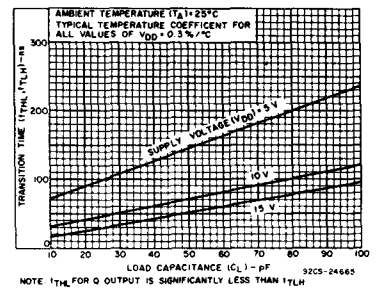

Fig. 6—Typical p-channel drain characteristics for Q output.



NOTE: t<sub>TH</sub> FOR Q OUTPUT IS SIGNIFICANTLY LESS THAN t<sub>FL</sub>.

Fig. 7—Typical transition time vs. C<sub>L</sub> for data outputs.

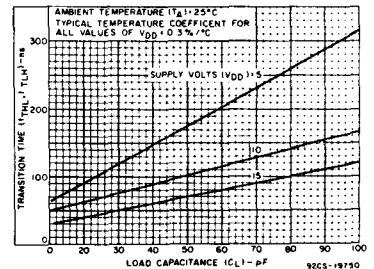

Fig. 8—Typical transition time vs. C<sub>L</sub> for delayed clock output.



# CD4062A Types

**DYNAMIC CHARACTERISTICS AT  $T_A = 25^\circ\text{C}$ ,  $V_{SS} = 0\text{V}$ ,  $C_L = 50\text{pF}$ , Input  $t_r, t_f = 20\text{ns}$ , except  $t_{rCL}$  and  $t_{fCL}$**

**Single-Phase-Clock Operation; Clock Mode (CM) = Low;  $3\text{V} < V_{DD} \leq 10\text{V}$  (See Figure 3)**

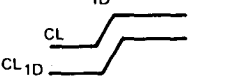
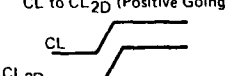
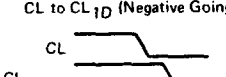
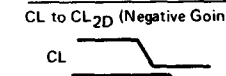
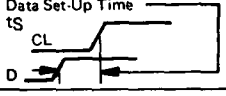
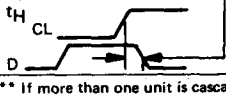
CHARACTERISTIC	TEST CONDITIONS	LIMITS			UNITS	
		$V_{DD}$ V	MIN.	TYP.		MAX.
Maximum Clock Input Frequency, $f_{CL}$ (50% Duty Cycle)	$t_r, t_f = 20\text{ns}$	5	0.5	1	—	MHz
		10	1	2	—	
Minimum Clock Input Frequency, $f_{CL}$ (50% Duty Cycle)		5	150	10	—	Hz
		10	150	10	—	
Clock Rise and Fall Times** $t_{rCL}, t_{fCL}$		5	—	—	10	$\mu\text{s}$
		10	—	—	1	
Average Input Capacitance, $C_1$	All Inputs Except $CL_1$ and $CL_2$		—	5.	—	pF
Propagation Delays :						
CL to Q		5	—	1000	2000	ns
CL to $CL_{1D}$ (Positive Going)		10	—	400	800	
 CL to $CL_{1D}$ (Positive Going)	(50% Points)	5	—	750	1500	ns
		10	—	300	600	
 CL to $CL_{2D}$ (Positive Going)	(50% Points)	5	—	500	1000	ns
		10	—	200	400	
 CL to $CL_{1D}$ (Negative Going)	(50% Points)	5	—	450	900	ns
		10	—	175	350	
 CL to $CL_{2D}$ (Negative Going)	(50% Points)	5	—	750	1500	ns
		10	—	300	600	
Transition Time: $t_{TLH}, t_{THL}$ Q Output		5	—	100	200	ns
	$CL_{1D}, CL_{2D}$	10	—	50	100	
Data Set-Up Time $t_S$		5	—	—	0	ns
		10	—	—	0	
Data Hold Time $t_H$		5	—	—	150	ns
		10	—	—	150	

\*\* If more than one unit is cascaded in single-phase parallel clocked application,  $t_{rCL}$  should be made less than or equal to the sum of the propagation delay at 15 pF, and the transition time of the output driving stage. (See Figs. 5 and 7 for cascading options.)

▲ Use of delayed clock permits high-speed logic to precede CD4062A register (see cascade register operation).

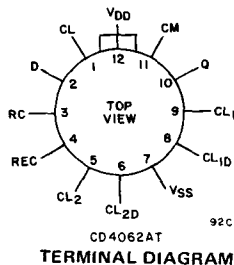

92CS-22693

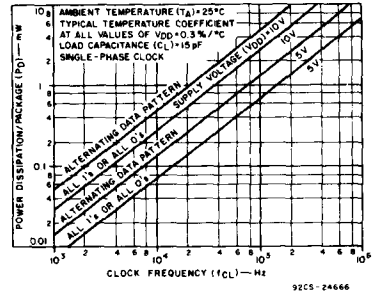

Fig. 9— Typical power dissipation vs. frequency.

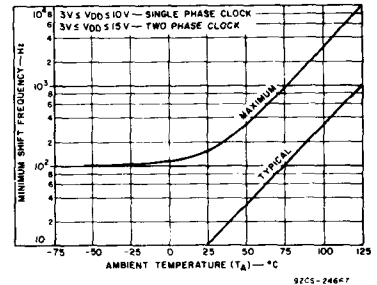

Fig. 10— Minimum shift frequency vs. ambient temperature.

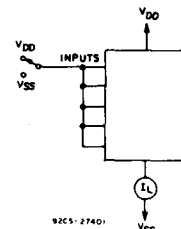

Fig. 11— Quiescent device current test circuit.

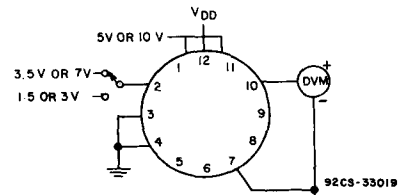

Fig. 12— Noise immunity test circuit.

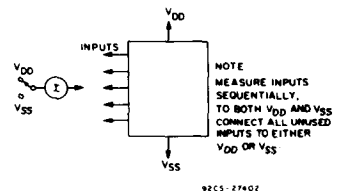

Fig. 13— Input leakage current test circuit.

# CD4066A Types

## CMOS Quad Bilateral Switch

For Transmission or Multiplexing of Analog or Digital Signals

RCA CD4066A is a quad bilateral switch intended for the transmission or multiplexing of analog or digital signals. It is pin-for-pin compatible with RCA-CD4016, but exhibits a much lower ON resistance. In addition, the ON resistance is relatively constant over the full input-signal range.

The CD4066A consists of four independent bilateral switches. A single control signal is required per switch. Both the p and the n device in a given switch are biased ON or OFF simultaneously by the control signal. As shown in Fig. 1, the well of the n-channel device on each switch is either tied to the input when the switch is ON or to  $V_{SS}$  when the switch is OFF. This configuration eliminates the variation of the switch-transistor threshold voltage with input signal, and thus keeps the ON resistance low over the full operating-signal range.

The advantages over single-channel switches include peak input-signal voltage swings equal to the full supply voltage, and more constant ON impedance over the input-signal range. For sample-and-hold applications, however, the CD4016 is recommended.

These types are supplied in 14-lead hermetic dual-in-line ceramic packages (D and F suffixes), 14-lead dual-in-line plastic package (E suffix), 14-lead ceramic flat package (K suffix), and in chip form (H suffix).

### SPECIAL CONSIDERATIONS - CD4066A

- In applications where separate power sources are used to drive  $V_{DD}$  and the signal inputs, the  $V_{DD}$  current capability should exceed  $V_{DD}/R_L$  ( $R_L$  = effective external load of the 4 CD4066A bilateral switches). This provision avoids any permanent current flow or clamp action on the  $V_{DD}$  supply when power is applied or removed from CD4066A.
- In certain applications, the external load-resistor current may include both  $V_{DD}$  and signal-line components. To avoid drawing  $V_{DD}$  current when switch current flows into terminals 1, 4, 8, or 11, the voltage drop across the bidirectional switch must not exceed 0.8 volt (calculated from  $R_{ON}$  values shown).
- No  $V_{DD}$  current will flow through  $R_L$  if the switch current flows into terminals 2, 3, 9, or 10.
- Minimum bilateral switch output load resistance is 100  $\Omega$ .

### Features:

- 15-V digital or  $\pm 7.5$ -V peak-to-peak switching
- 80 $\Omega$  typical ON resistance for 15-V operation
- Switch ON resistance matched to within 5  $\Omega$  over 15-V signal-input range
- ON resistance flat over full peak-to-peak signal range
- High ON/OFF output-voltage ratio: 65 dB typ. @  $f_{is} = 10$  kHz,  $R_L = 10$  k $\Omega$
- High degree of linearity: < 0.5% distortion typ. @  $f_{is} = 1$  kHz,  $V_{is} = 5$  V<sub>p-p</sub>,  $V_{DD} - V_{SS} \geq 10$  V,  $R_L = 10$  k $\Omega$
- Extremely low OFF switch leakage resulting in very low offset current and high effective OFF resistance: 10 pA typ. @  $V_{DD} - V_{SS} = 10$  V,  $T_A = 25^\circ\text{C}$
- Extremely high control input impedance (control circuit isolated from signal circuit):  $10^{12}$   $\Omega$  typ.
- Low crosstalk between switches: -50 dB typ. @  $f_{is} = 0.9$  MHz,  $R_L = 1$  k $\Omega$
- Matched control-input to signal-output capacitance: Reduces output signal transients
- Frequency response, switch ON = 40 MHz (typ.)
- Quiescent current specified to 15-V
- Maximum control input leakage current of 1- $\mu\text{A}$  at 15-V (Full package-temperature range)

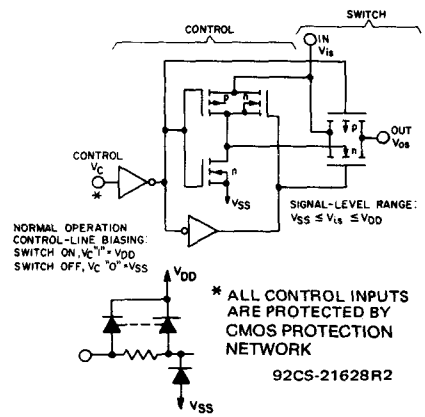
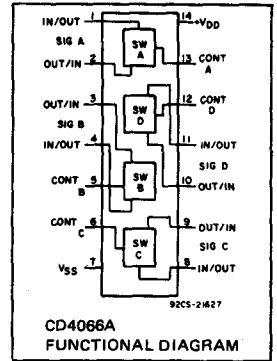

### MAXIMUM RATINGS, Absolute-Maximum Values:

STORAGE TEMPERATURE RANGE ( $T_{stg}$ )	-65 to +125 $^\circ\text{C}$
OPERATING TEMPERATURE RANGE ( $T_A$ ):	
PACKAGE TYPES D, F, K, H	-55 to +125 $^\circ\text{C}$
PACKAGE TYPE E	-40 to +85 $^\circ\text{C}$
DC SUPPLY VOLTAGE RANGE, $V_{DD}$ (Voltages referenced to $V_{SS}$ )	-0.5 to +15 V
INPUT CURRENT (TRANSMISSION GATE INCL.)	$\pm 10$ mA
POWER DISSIPATION PER PACKAGE:	
FOR $T_A = -40$ to +60 $^\circ\text{C}$ (PACKAGE TYPE E)	500 mW
FOR $T_A = +60$ to +85 $^\circ\text{C}$ (PACKAGE TYPE E) Derate Linearly at 12 mW/ $^\circ\text{C}$	200 mW
FOR $T_A = -55$ to +100 $^\circ\text{C}$ (PACKAGE TYPES D, F, K)	500 mW
FOR $T_A = +100$ to +125 $^\circ\text{C}$ (PACKAGE TYPES D, F, K) Derate Linearly at 12 mW/ $^\circ\text{C}$	200 mW
DEVICE DISSIPATION PER SECTION:	
FOR $T_A = \text{FULL PACKAGE TEMPERATURE RANGE (ALL PACKAGE TYPES)}$	100 mW
ALL SIGNAL AND DIGITAL CONTROL INPUTS	$V_{SS} \leq V_i \leq V_{DD}$
LEAD TEMPERATURE (DURING SOLDERING):	
At distance 1/16 $\pm$ 1/32 inch (1.59 $\pm$ 0.79 mm) from case for 10 s max.	+265 $^\circ\text{C}$

### OPERATING CONDITIONS AT $T_A = 25^\circ\text{C}$

For maximum reliability, nominal operating conditions should be selected so that operation is always within the following ranges.

CHARACTERISTIC	$V_{DD}$	MIN.	MAX.	UNITS
Supply Voltage Range ( $T_A = \text{Full Package Temperature Range}$ )	-	3	12	V

# CD4066A Types

## Applications:

- Analog signal switching/multiplexing
  - Signal gating
  - Modulator
  - Squelch control
  - Demodulator
  - Chopper
  - Commutating switch
- Digital signal switching/Multiplexing
- Transmission-gate logic implementation
- Analog-to-digital & digital-to-analog conversion
- Digital control of frequency, impedance, phase, and analog-signal gain

## ELECTRICAL CHARACTERISTICS

CHARACTERISTIC	TEST CONDITIONS All Voltage Values Are in Volts		LIMITS						UNITS	
			Values at -55°C, +25°C, +125°C Apply to D, F, K, H Packages							
			Values at -40°C, +25°C, +85°C Apply to E Package							
	V <sub>DD</sub> (V)	-55°	-40°	+85°	+125°	+25°				
						TYP.	MAX.			
Quiescent Device Current, <i>I</i> <sub>L</sub> max. D, F, H Pkgs.	5	0.25	-	-	7.5	0.01	0.25	μA		
	10	0.5	-	-	15	0.01	0.5	μA		
	15	2	-	-	40	0.02	2	μA		
E Pkg.	5	-	2.5	15	-	0.25	2.5	μA		
	10	-	5	30	-	0.25	5	μA		
	15	-	50	500	-	0.5	50	μA		
SIGNAL INPUTS (V <sub>is</sub> ) AND OUTPUTS (V <sub>os</sub> )										
ON Resistance, R <sub>ON</sub> Max.	V <sub>C</sub> = V <sub>DD</sub>	V <sub>SS</sub>	V <sub>is</sub>							
	R <sub>L</sub> = 10kΩ*			220	250	300	320	80	280	Ω
	+7.5	-7.5	-7.5 to +7.5							
	+15	0	0 to +15							
	+5	-5	-5 to +5	400	450	520	550	120	500	
	+10	0	0 to +10							
	+2.5	-2.5	-2.5 to +2.5	3000	3500	5200	5500	270	5000	
-5	0	0 to +5								
Δ ON Resistance Between Any 2 of 4 Switches, Δ R <sub>ON</sub>	R <sub>L</sub> = 10kΩ*						5	-	Ω	
	+7.5	-7.5	+7.5 to -7.5							
	+15	0	+15 to 0							
Sine Wave Response (Distortion)	R <sub>L</sub> = 10kΩ f <sub>is</sub> = 1kHz						0.4	-	%	
	+5	-5	-5 p-p							
Frequency Response Switch ON (Sine-Wave Input)	R <sub>L</sub> = 1kΩ						40	-	MHz	
	20 log <sub>10</sub> $\frac{V_{os}}{V_{is}}$ = -3dB									
Feedthrough-Switch OFF	R <sub>L</sub> = 1kΩ						1.25	-	MHz	
	20 log <sub>10</sub> $\frac{V_{os}}{V_{is}}$ = -50dB									
Input or Output Leakage – Switch OFF (Effective OFF Resistance)	V <sub>DD</sub>	V <sub>C</sub> = V <sub>SS</sub>					±0.1	±100*	nA	
	+7.5	-7.5	±7.5							
	+5	-5	±5							
Crosstalk Between Any 2 of the 4 Switches (f at -50 dB)	V <sub>C</sub> (A) = V <sub>DD</sub> +5 V <sub>C</sub> (B) = V <sub>SS</sub> -5 R <sub>L</sub> = 1kΩ	(A) 5V p-p					0.9	-	MHz	
	20 log <sub>10</sub> $\frac{V_{os}(B)}{V_{is}(A)}$ = -50dB									

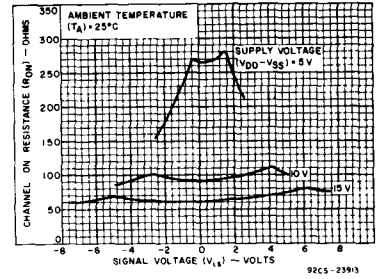

Fig. 2 (a) – Typical channel ON resistance vs. signal voltage for three values of supply voltage (V<sub>DD</sub> - V<sub>SS</sub>) = 5V.

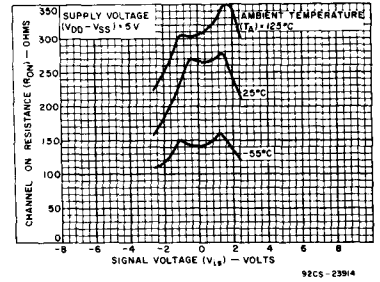

Fig. 2 (b) – Typical channel ON resistance vs. signal voltage with supply voltage (V<sub>DD</sub> - V<sub>SS</sub>) = 5V.

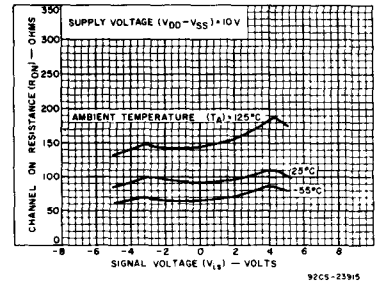

Fig. 2 (c) – Typical channel ON resistance vs. signal voltage with supply voltage (V<sub>DD</sub> - V<sub>SS</sub>) = 10V.

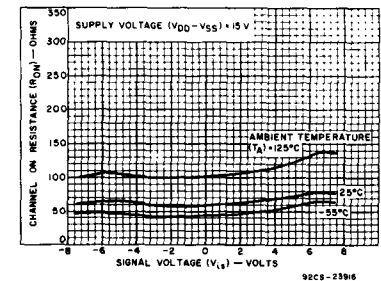

Fig. 2 (d) – Typical channel ON resistance vs. signal voltage with supply voltage (V<sub>DD</sub> - V<sub>SS</sub>) = 15V.

# CD4066A Types

## ELECTRICAL CHARACTERISTICS (Cont'd)

CHARACTERISTIC	TEST CONDITIONS All Voltage Values Are in Volts	LIMITS						UNITS
		Values at -55°C, +25°C, +125°C Apply to D, F, K, H Packages Values at -40°C, +25°C, +85°C Apply to E Package						
		V <sub>DD</sub> (V)		-55°	-40°	+85°	+125°	
						TYP.	MAX.	
Propagation Delay (Signal Input to Signal Output) <i>t</i> <sub>pd</sub>	V <sub>DD</sub> = 5 V <sub>SS</sub> = GND C <sub>L</sub> = 15pF V <sub>is</sub> = sq. wave	-	-	-	-	20	50	ns
	V <sub>DD</sub> = 10 V <sub>is</sub> = 20 ns (Input Signal)	-	-	-	-	10	25	
Capacitance: Input, C <sub>is</sub> Output, C <sub>os</sub> Feedthrough, C <sub>ios</sub>	V <sub>DD</sub> = +5 V <sub>CC</sub> = V <sub>SS</sub> = -5	-	-	-	-	8	-	pF
		-	-	-	-	8	-	
		-	-	-	-	0.5	-	
<b>CONTROL (V<sub>C</sub>)</b>								
Noise Immunity, V <sub>NL</sub> Min.	V <sub>is</sub> ≤ V <sub>DD</sub> I <sub>is</sub> = 10μA V <sub>DD</sub> - V <sub>SS</sub> = 10	2	2	2	2	2 min 4.5	-	V
Input Leakage Current, I <sub>IL</sub> Max.	V <sub>is</sub> ≤ V <sub>DD</sub> V <sub>DD</sub> - V <sub>SS</sub> = 15 V <sub>C</sub> ≤ V <sub>DD</sub> - V <sub>SS</sub>	-	-	±1	-	±10 <sup>-6</sup>	±1	μA
Crosstalk Control Input to Signal Output	V <sub>DD</sub> - V <sub>SS</sub> = 10 V <sub>C</sub> = 10 (sq. wave) R <sub>L</sub> = 10kΩ	-	-	-	-	50	-	mV
Propagation Delay, <i>t</i> <sub>pdC</sub>	<i>t</i> <sub>rc</sub> = <i>t</i> <sub>fc</sub> = 20 ns R <sub>L</sub> = 300kΩ V <sub>is</sub> ≤ 10 C <sub>L</sub> = 15pF	-	-	-	-	35	-	ns
Maximum Allowable Control Input Repetition Rate	V <sub>DD</sub> = 10, V <sub>SS</sub> = GND R <sub>L</sub> = 1kΩ, C <sub>L</sub> = 15pF V <sub>C</sub> = 10 (sq. wave) <i>t</i> <sub>r</sub> , <i>t</i> <sub>f</sub> = 20 ns	-	-	-	-	10	-	MHz
Av. Input Capacitance, C <sub>I</sub>		-	-	-	-	5	-	pF

\* Limit determined by minimum feasible leakage measurement for automatic testing.

Δ Symmetrical about 0 volts. • For all test conditions.

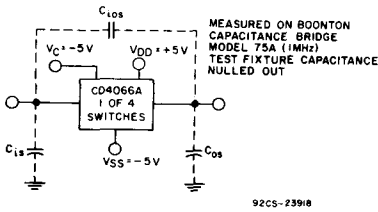

Fig. 6 - Capacitance test circuit.

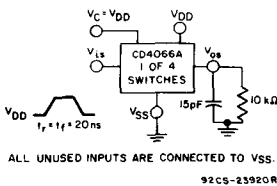

Fig. 8 - Propagation delay time signal input (V<sub>is</sub>) to signal output (V<sub>os</sub>).

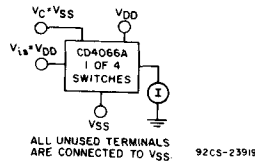

Fig. 7 - OFF switch input or output leakage.

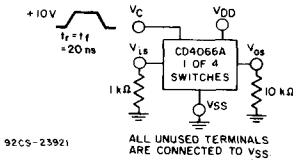

Fig. 9 - Crosstalk-control input to signal output.

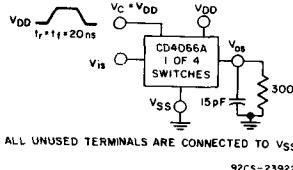

Fig. 11 - Propagation delay *t*<sub>PLH</sub>, *t*<sub>PHL</sub> control-signal output.

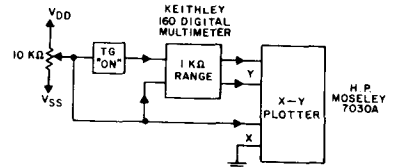

Fig. 3 - Channel ON resistance measurement circuit.

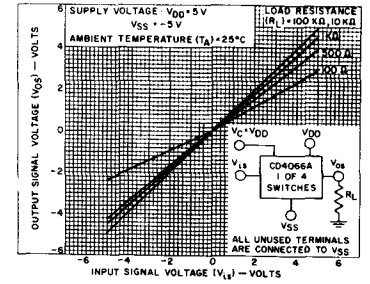

Fig. 4 - Typical ON characteristics for 1 of 4 channels.

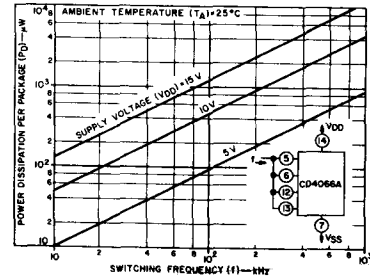

Fig. 5 - Power dissipation per package vs. switching frequency.

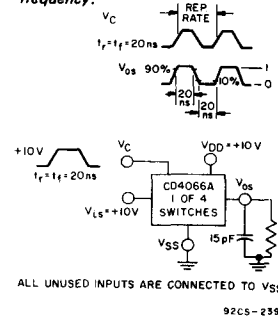

Fig. 10 - Maximum allowable control input repetition rate.

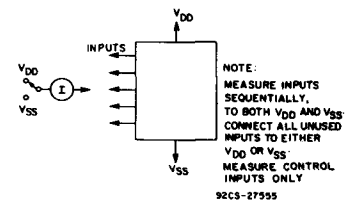

Fig. 12 - Input leakage current test circuit.

---

# **CMOS Telecommunica- tions, Display-Driver, and Interface Circuits**

## **Technical Data**

# CA3300 Types

## CMOS Video Speed 6-Bit Flash Analog-to-Digital Converter

For Use in Low-Power Consumption, High-Speed Digitization Applications

### Features:

- CMOS low power with speed
- Parallel conversion technique
- 15-MHz sampling rate (66-ns conversion time)
- 6-bit latched 3-state output with overflow bit
- $\pm 1/2$  LSB accuracy
- Single supply voltage (3 to 10 V)
- 2 units in series allow 7-bit output
- 2 units in parallel allow 30-MHz sampling rate
- Internal  $V_{REF}$  with ext  $V_{REF}$  option
- Available with EVP processing for improved reliability

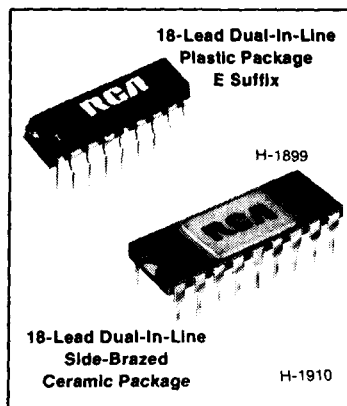

The RCA-CA3300 types are CMOS 50-mW parallel (FLASH) analog-to-digital converters designed for applications demanding both low-power consumption and high-speed digitization.

The CA3300 types operate over a wide full-scale input-voltage range of 2.4 volts up to the dc supply voltage with maximum power consumption as low as 50 to 200 mW, depending upon the clock frequency selected. When operated from a 5-volt supply at a clock frequency of 11 MHz, the power consumption of the CA3300 is less than 50 mW. When operated from an 8-volt supply at a frequency of 15 MHz, the power consumption is less than 150 mW.

The intrinsic high conversion rate makes the CA3300 types ideally suited for digitizing high-speed signals. The overflow bit makes possible the connection of two or more CA3300's in series to increase the resolution of the conversion system. A series connection of two CA3300's may be used to produce a 7-bit high-speed converter. Operation of two CA3300's in parallel doubles the conversion speed (i.e., increases the sampling rate from 15 to 30 MHz). CA3300's in parallel may be combined with a high-speed 6-bit D/A converter, a binary adder, control logic, and an op amp to form a very-high-speed A/D converter.

Sixty-four paralleled auto-balanced voltage comparators measure the input voltage with respect to a known reference to produce the parallel-bit outputs in the CA3300. Sixty-three comparators are required to quantize all input voltage levels in this 6-bit converter, and the additional comparator is required for the overflow bit.

The CA3300 types are available as follows: Types CA3300D and CA3300DX in an 18-lead dual-in-line ceramic package (D suffix), types CA3300E and CA3300CE in an 18-lead dual-in-line plastic package (E suffix), or in chip form (H suffix). The CA3300DX offers the additional advantage of improved reliability as a result of EVP (Extra Value Program) processing. For further information on EVP, see RCA publication EVP-300B or contact your RCA representative.

### Applications:

- The CA3300 types are especially suited for high-speed conversion applications where low power is also important
- TV video digitizing (industrial/security)
- High-speed A/D conversion
- Ultrasound signature analysis
- Transient signal analysis
- High-energy physics research
- High-speed oscilloscope storage/display
- General-purpose hybrid ADC's
- Optical character recognition
- Radar pulse analysis
- Motion signature analysis

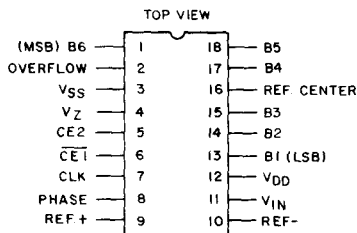

92CS-32263RI

### TERMINAL ASSIGNMENT

# CA3300 Types

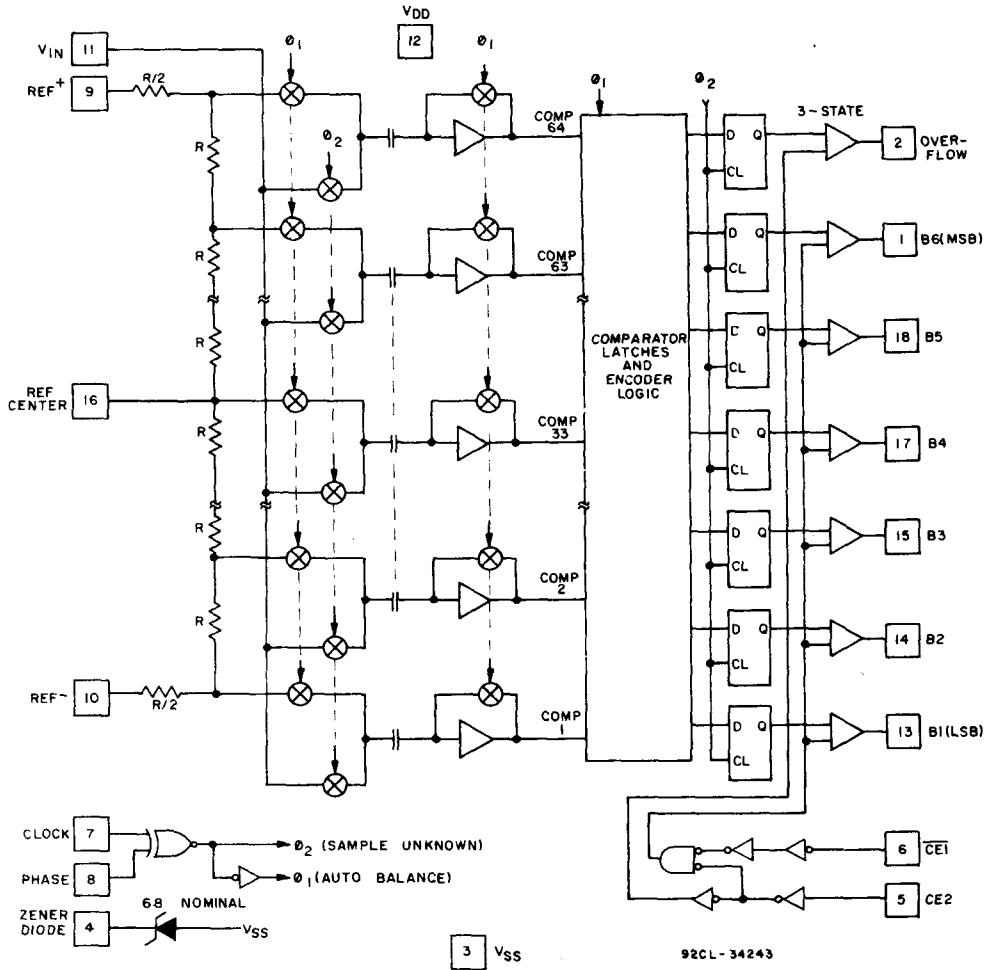

Fig. 1 - Block diagram for the CA3300.

## MAXIMUM RATINGS, Absolute-Maximum Values:

DC SUPPLY VOLTAGE RANGE ( $V_{DD}$ ) (VOLTAGE REFERENCED TO $V_{SS}$ TERMINAL) .....	-0.5 to 10 V
INPUT VOLTAGE RANGE ALL INPUTS EXCEPT ZENER (PIN 4) .....	-0.5 to $V_{DD} + 0.5$ V
DC INPUT CURRENT CLK, PH, $\overline{CE1}$ , CE2, $V_{IN}$ .....	$\pm 10$ mA
POWER DISSIPATION PER PACKAGE ( $P_D$ ) FOR $T_A = -55$ to $+55^\circ\text{C}$ .....	315 mW
FOR $T_A = +55^\circ\text{C}$ to $+125^\circ\text{C}$ .....	Derate linearly at 3.3 mW/ $^\circ\text{C}$
TEMPERATURE RANGE OPERATING (CA3300DX, Refer to Fig. 3) .....	$-55$ to $+125^\circ\text{C}$
OPERATING (CA3300D, E, CE) .....	$-40$ to $+85^\circ\text{C}$
STORAGE .....	$-65$ to $+150^\circ\text{C}$
LEAD TEMPERATURE (DURING SOLDERING) At distance $1/16 \pm 1/32$ in. ( $1.59 \pm 0.79$ mm) from case for 10 s max. ....	$+285^\circ\text{C}$

# CA3300 Types

## ELECTRICAL CHARACTERISTICS

CHARACTERISTIC	TEST CONDITIONS @ 25°C	LIMITS			UNITS
		CA3300D, DX, E			
		MIN.	TYP.	MAX.	
Resolution		—	—	6	Bits
Linearity Error	$V_{DD}=8\text{ V}$ , $V_{REF}=7.68\text{ V}$ $CLK=15\text{ MHz}$ , gain adjusted	—	$\pm 0.5$	$\pm 0.8$	LSB
Differential Linearity Error	$V_{DD}=8\text{ V}$ , $V_{REF}=7.68\text{ V}$ $CLK=15\text{ MHz}$	—	$\pm 0.5$	$\pm 0.8$	
Quantizing Error		$-\frac{1}{2}$	—	$\frac{1}{2}$	
Analog Input:	$V_{DD}=8\text{ V}$				
Full Scale Range	$CLK=15\text{ MHz}$	2.4	—	$V_{DD}+0.5$	V
Input Capacitance		—	50	—	pF
Input Current		—	600	1000	$\mu\text{A}$
Gain Temperature Coefficient	$V_{DD}=8\text{ V}$ , $CLK=15\text{ MHz}$	—	0.016	—	LSB/°C
Maximum Conversion Speed	$V_{DD}=5\text{ V}$	—	12M	—	SPS
	$V_{DD}=8\text{ V}$	15M	19M	—	
Device Current (Excludes $I_{REF}$ , $I_Z$ )	$V_{DD}=5\text{ V}$ ( $CLK=11\text{ MHz}$ )	—	7	—	mA
	$V_{DD}=8\text{ V}$ ( $CLK=15\text{ MHz}$ )	—	22	—	
	$V_{DD}=5\text{ V}$ (Auto Balance State)	—	6.4	16	
	$V_{DD}=8\text{ V}$ (Auto Balance State)	—	24	40	
Ladder Impedance		1000	1400	1800	$\Omega$
Digital Inputs:					
Low Voltage	$V_{DD}=5\text{ V}$	—	—	1.5	V
	$V_{DD}=8\text{ V}$	—	—	2.5	
High Voltage	$V_{DD}=5\text{ V}$	3.5	—	—	V
	$V_{DD}=8\text{ V}$	5.5	—	—	
Input Current	$V_{DD}=8\text{ V}$	—	$\pm 1$	—	$\mu\text{A}$
Digital Outputs:					
Output Low (Sink) Current	$V_{DD}=5\text{ V}$ , $V_O=0.4\text{ V}$	1.6	10	—	mA
	$V_{DD}=8\text{ V}$ , $V_O=0.5\text{ V}$	3.2	15	—	
Output High (Source) Current	$V_{DD}=5\text{ V}$ , $V_O=4.6\text{ V}$	-0.8	6	—	
	$V_{DD}=8\text{ V}$ , $V_O=7.5\text{ V}$	-1.6	9	—	
Zener Voltage	$I_Z=10\text{ mA}$	6.2	6.8	7.4	V
Zener Dynamic Impedance	$I_Z=10\text{ mA}$	—	10	30	$\Omega$
Zener Temperature Coefficient		—	0.5	—	mV/°C
Digital Output Delay, $t_d$	$V_{DD}=8\text{ V}$	—	20	—	ns
Aperture Time	$V_{DD}=8\text{ V}$	—	25	—	

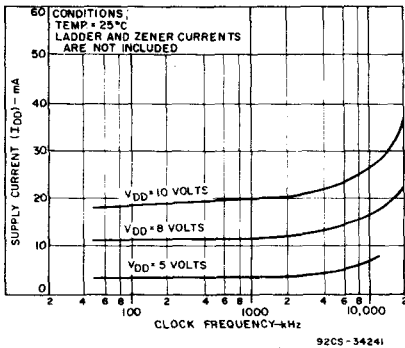

Fig. 2 - Typical current drain versus sampling rate as a function of supply voltage.

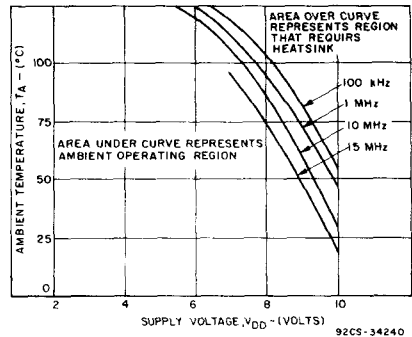

Fig. 3 - Maximum ambient temperature versus supply voltage. (Above curve includes ladder dissipation but not the zener dissipation.)



ELECTRICAL CHARACTERISTICS

CHARACTERISTIC	TEST CONDITIONS @ 25°C	LIMITS			UNITS
		CA3300CE			
		MIN.	TYP.	MAX.	
Resolution		—	—	6	Bits
Linearity Error	V <sub>DD</sub> =8 V, V <sub>REF</sub> =7.68 V CLK=9 MHz, gain adjusted	—	±0.5	±0.8	LSB
Differential Linearity Error	V <sub>DD</sub> =8 V, V <sub>REF</sub> =7.68 V CLK=9 MHz	—	±0.5	±0.8	
Quantizing Error		-½	—	½	
Analog Input:	V <sub>DD</sub> =8 V				
Full Scale Range	CLK=9 MHz	2.4	—	V <sub>DD</sub> +0.5	V
Input Capacitance		—	50	—	pF
Input Current		—	450	1000	µA
Gain Temperature Coefficient	V <sub>DD</sub> =8 V, CLK=9 MHz	—	0.016	—	LSB/°C
Maximum Conversion Speed	V <sub>DD</sub> =5 V	6M	—	—	SPS
	V <sub>DD</sub> =8 V	9M	19M	—	
Device Current (Excludes I <sub>REF</sub> , I <sub>Z</sub> )	V <sub>DD</sub> =5 V (CLK=7 MHz)	—	4	—	mA
	V <sub>DD</sub> =8 V (CLK=9 MHz)	—	12	—	
	V <sub>DD</sub> =5 V (Auto Balance State)	—	6.4	16	
	V <sub>DD</sub> =8 V (Auto Balance State)	—	24	40	
Ladder Impedance		1000	1400	1800	Ω
Digital Inputs:					
Low Voltage	V <sub>DD</sub> =5 V	—	—	1.5	V
	V <sub>DD</sub> =8 V	—	—	2.5	
High Voltage	V <sub>DD</sub> =5 V	3.5	—	—	V
	V <sub>DD</sub> =8 V	5.5	—	—	
Input Current	V <sub>DD</sub> =8 V	—	±1	—	µA
Digital Outputs:					
Output Low (Sink) Current	V <sub>DD</sub> =5 V, V <sub>O</sub> =0.4 V	1.6	10	—	mA
	V <sub>DD</sub> =8 V, V <sub>O</sub> =0.5 V	3.2	15	—	
Output High (Source) Current	V <sub>DD</sub> =5 V, V <sub>O</sub> =4.6 V	-0.8	6	—	
	V <sub>DD</sub> =8 V, V <sub>O</sub> =7.5 V	-1.6	9	—	
Zener Voltage	I <sub>Z</sub> =10 mA	6.2	6.8	7.4	V
Zener Dynamic Impedance	I <sub>Z</sub> =10 mA	—	10	30	Ω
Zener Temperature Coefficient		—	0.5	—	mV/°C
Digital Output Delay, t <sub>d</sub>	V <sub>DD</sub> =8 V	—	20	—	ns
Aperture Time	V <sub>DD</sub> =8 V	—	25	—	

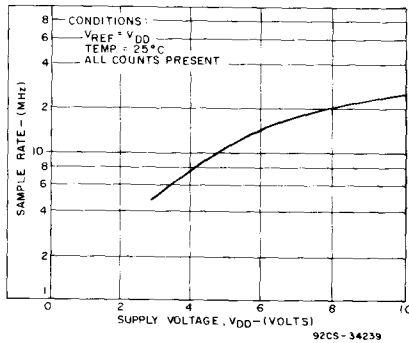

Fig. 4 - Typical maximum sample rate versus supply voltage.

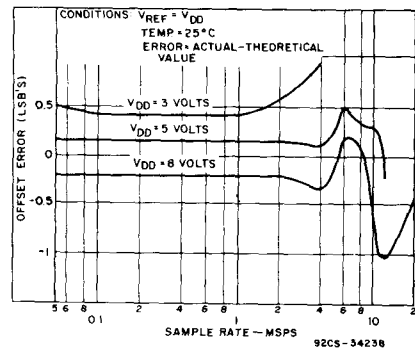

Fig. 5 - Typical offset error versus sample rate as a function of supply voltage. (See literature for offset trim.)

# CA3300 Types

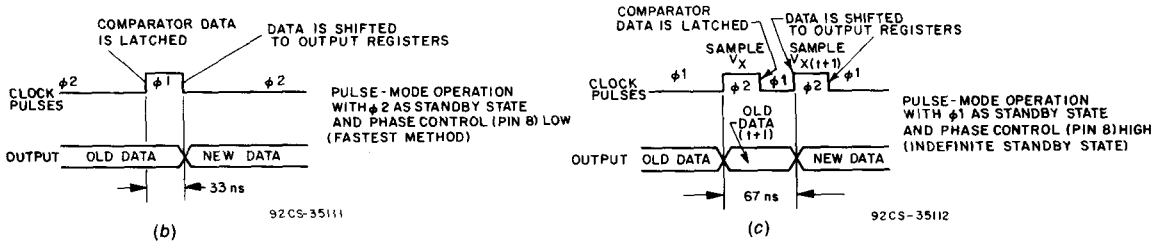
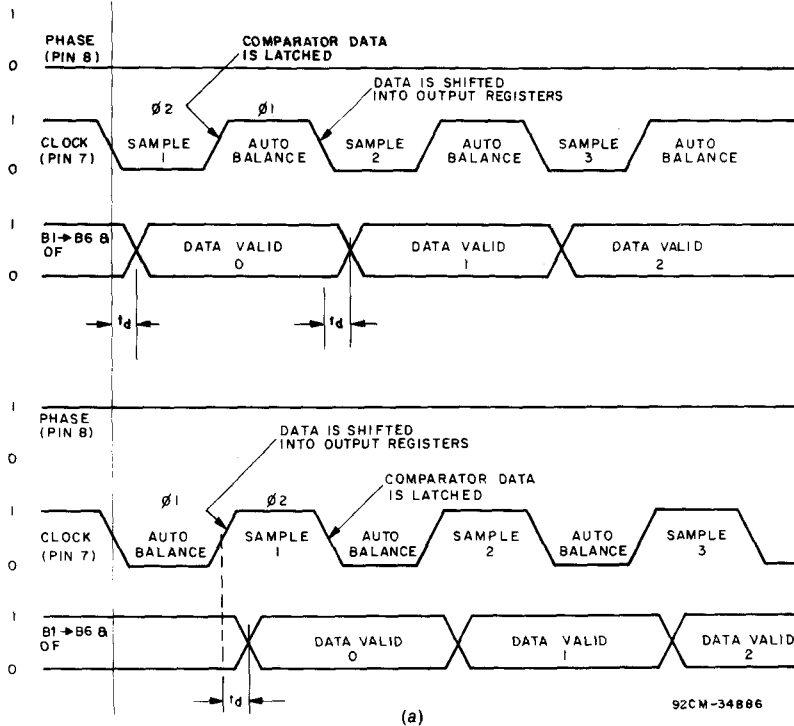

Fig. 6 - Timing diagrams for the CA3300.

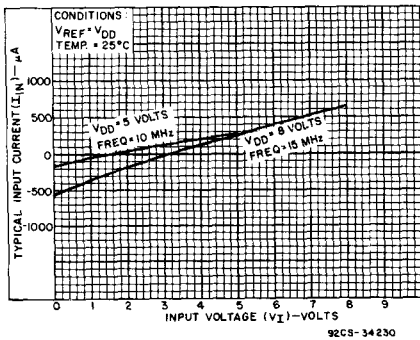

Fig. 7 - Typical input current versus input voltage as a function of supply voltage.

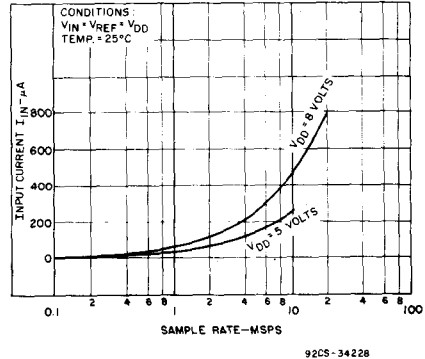

Fig. 8 - Typical input current versus sample rate as a function of supply voltage.

## CA3300 Types

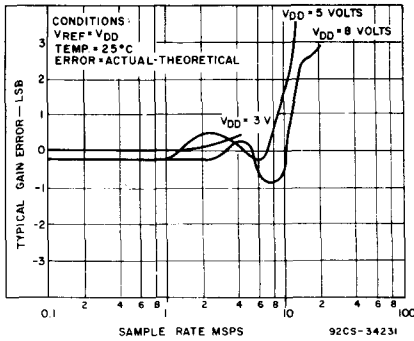

Fig. 9 - Typical gain error versus sample rate as a function of supply voltage. (See literature for gain trim.)

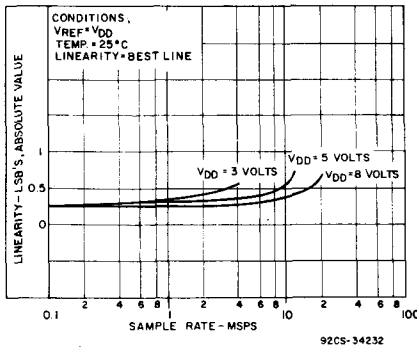

Fig. 10 - Typical linearity versus sample rate as a function of supply voltage.

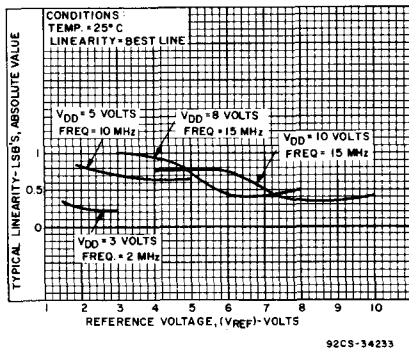

Fig. 11 - Typical linearity versus reference voltage as a function of supply voltage.

### Device Operation

A sequential parallel technique is used by the CA3300 converter to obtain its high-speed operation. The sequence consists of the "Auto Balance" phase  $\phi 1$  and the "Sample Unknown" phase  $\phi 2$ . (Refer to the circuit diagram.) Each conversion takes one clock cycle.\* With the phase control (pin 8) low, the "Auto Balance" ( $\phi 1$ ) occurs during the High period of the clock cycle, and the "Sample Unknown" ( $\phi 2$ ) occurs during the low period of the clock cycle.

During the "Auto Balance" phase, a transmission switch is used to connect each of 64 commutating capacitors to their

associated ladder reference tap. Those tap voltages will be as follows:

$$V_{\text{LAD}}(N) = [(V_{\text{REF}}/64) \times N] - [V_{\text{REF}}/(2 \times 64)] \\ = V_{\text{REF}}[(2N - 1)/128]$$

Where:  $V_{\text{LAD}}(n)$  = reference ladder tap voltage at point  $n$

$V_{\text{REF}}$  = voltage across  $R^-$  to  $R^+$

$N$  = tap number (1 through 64)

The other side of the capacitor is connected to a single stage amplifier whose output is shorted to its input by a switch. This biases the amplifier at its intrinsic trip point, which is approximately,  $(V_{\text{DD}} - V_{\text{SS}})/2$ . The capacitors now charge to their associated tap voltages, priming the circuit for the next phase.

In the "Sample Unknown" phase, all ladder tap switches are opened, the comparator amplifiers are no longer shorted, and  $V_{\text{IN}}$  is switched to all 64 capacitors. Since the other end of the capacitor is now looking into an effectively open circuit, any voltage that differs from the previous tap voltage will appear as a voltage shift at the comparator amplifiers. All comparators with tap voltages greater than  $V_{\text{IN}}$  will drive the comparator outputs to a "low" state, all comparators with tap voltage lower than  $V_{\text{IN}}$  will drive the comparator outputs to a "high" state.

The status of all these comparator amplifiers are stored at the end of this phase ( $\phi 2$ ), by a secondary latching amplifier stage. Once latched, the status of the 64 comparators is decoded by a 64-to 7-bit decode array and the results are clocked into a storage register at the rising edge of the next  $\phi 2$ .

A 3-state buffer is used at the output of the 7 storage registers which are controlled by two chip-enable signals.  $\overline{\text{CE1}}$  will independently disable B1 through B6 when it is in a high state.  $\overline{\text{CE2}}$  will independently disable B1 through B6 and the OF buffers when it is in the low state.

To facilitate usage of this device a phase-control input is provided which can effectively complement the clock as it enters the chip. Also, an on-board zener is provided for use as a reference voltage.

### Continuous Clock Operation

One complete conversion cycle can be traced through the CA3300 via the following steps. (Refer to timing diagram Fig. 6a.) With the phase control in a 'High' state, the rising edge of the clock input will start a "sample" phase. During this entire 'High' state of the clock, the 64 comparators will track the input voltage and the 64 latches will track the comparator outputs. At the falling edge of the clock, all 64 comparator outputs are captured by the 64 latches. This ends the "sample" phase and starts the "auto balance" phase for the comparators. During this 'Low' state of the clock the output of the latches propagates through the decode array and a 7-bit code appears at the D inputs of the output registers. On the next rising edge of the clock, this 7-bit code is shifted into the output registers and appears with time delay  $t_d$  as valid data at the output of the 3-state drivers. This also marks the start of a new "sample" phase, thereby repeating the conversion process for this next cycle.

### Pulse Mode Operation

For sampling high-speed nonrecurrent or transient data, the converter may be operated in a pulse mode in one of two ways. The fastest method is to keep the converter in the Sample Unknown phase,  $\phi 2$ , during the standby state. The

\* This device requires only a single phase clock. The terminology of  $\phi 1$  and  $\phi 2$  refers to the High and Low periods of the same clock.

## CA3300 Types

device can now be pulsed through the Auto Balance phase with as little as 33 ns. The analog value is captured on the leading edge of  $\phi_1$  and is transferred into the output registers on the trailing edge of  $\phi_1$ . We are now back in the standby state,  $\phi_2$ , and another conversion can be started within 33 ns, but not later than 1  $\mu$ s due to the eventual droop of the commutating capacitors. Another advantage of this method is that it has the potential of having the lowest power drain. The larger the time ratio between  $\phi_2$  and  $\phi_1$ , the lower the power consumption. (See timing diagram Fig. 6b.)

The second method uses the Auto Balance phase,  $\phi_1$ , as the standby state. In this state the converter can stay indefinitely waiting to start a conversion. A conversion is performed by strobing the clock input with two  $\phi_2$  pulses. The first pulse starts a Sample Unknown phase and captures the analog value in the comparator latches on the trailing edge. A second  $\phi_2$  pulse is needed to transfer the data into the output registers. This occurs on the leading edge of the second pulse. The conversion now takes place in 67 ns, but the repetition rate may be as slow as desired. The disadvantage to this method is the higher device dissipation due to the low ratio of  $\phi_2$  to  $\phi_1$ . (See timing diagram Fig. 6c.)

### Increased Accuracy

In most cases the accuracy of the CA3300 should be sufficient without any adjustments. In applications where accuracy is of utmost importance, three adjustments can be made to obtain better accuracy; i.e., offset trim, gain trim, and midpoint trim.

#### Offset Trim

In general offset correction can be done in the preamp circuitry by introducing a dc shift to  $V_{IN}$  or by the offset trim of the op amp. When this is not possible the  $R^-$  (pin 10) input can be adjusted to produce an offset trim. The theoretical input voltage to produce the first transition is  $\frac{1}{2}$  LSB. The equation is as follows:

$$V_{IN} (0 \text{ to } 1 \text{ transition}) = \frac{1}{2} \text{ LSB} = \frac{1}{2}(V_{REF}/64) \\ = V_{REF}/128$$

If  $V_{IN}$  for the first transition is less than the theoretical, then a single-turn 50-ohm pot connected between  $R^-$  and ground will accomplish the adjustment. Set  $V_{IN}$  to  $\frac{1}{2}$  LSB and trim the pot until the 0 to 1 transition occurs.

If  $V_{IN}$  for the first transition is greater than the theoretical, then the 50-ohm pot should be connected between  $R^-$  and a negative voltage of about 2 LSB's. The trim procedure is as stated previously.

#### Gain Trim

In general the gain trim can also be done in the preamp circuitry by introducing a gain adjustment for the op amp. When this is not possible, then a gain adjustment circuit should be made to adjust the reference voltage. To perform this trim,  $V_{IN}$  should be set to the 63 to overflow transition. That voltage is  $\frac{1}{2}$  LSB less than  $V_{REF}$  and is calculated as follows:

$$V_{IN} (63 \text{ to } 64 \text{ transition}) = V_{REF} - V_{REF}/128 \\ = V_{REF} (127/128)$$

To perform the gain trim, first do the offset trim and then apply the required  $V_{IN}$  for the 63 to overflow transition. Now adjust  $V_{REF}$  until that transition occurs on the outputs.

#### Midpoint Trim

The reference center (RC), pin 16, is available to the user as the approximate midpoint of the resistor ladder. The actual count that is brought out is count 33. To trim the midpoint,

the offset and gain trims should be done first. The theoretical transition from count 32 to 33 occurs at  $3\frac{1}{2}$  LSB's. That voltage is as follows:

$$V_{IN} (32 \text{ to } 33 \text{ transition}) = 32.5 (V_{REF}/64)$$

An adjustable voltage follower can be connected to the RC pin or a 2-K pot can be connected between  $R^+$  and  $R^-$  with the wiper connected to RC. Set  $V_{IN}$  to the 32 to 33 transition voltage, then adjust the voltage follower or the pot until the transition occurs on the output bits.

The Reference Center point can also be used to create some unique transfer functions. For example, if  $R^-$  is grounded, RC is connected to 3.25 volts, and  $R^+$  is connected to 4.8 volts then the lower order counts, 1 through 33, will have an LSB value of 100 mV while the upper order counts, 34 through Overflow, will have an LSB value of 50 mV. This effectively provides twice the sensitivity in the upper counts as compared to the lower counts.

### 7-Bit Resolution

To obtain 7-bit resolution, two CA3300's can be wired together. Necessary ingredients include an open-ended ladder network, an overflow indicator, three-state outputs, and chip-enabler controls—all of which are available on the CA3300.

The first step for connecting a 7-bit circuit is to totem-pole the ladder networks, as illustrated in Fig. 13. Since the absolute resistance value of each ladder may vary, external trim of the mid-reference voltage may be required.

The overflow output of the lower device now becomes the seventh bit. When it goes high, all counts must come from the upper device. When it goes low, all counts must come from the lower device. This is done simply by connecting the lower overflow signal to the  $\overline{CE1}$  control of the lower A/D converter and the CE2 control of the upper A/D converter. The three-state outputs of the two devices (bits 1 through 6) are now connected in parallel to complete the circuitry. The complete circuit for a 7-bit A/D converter is shown in Fig. 14.

### 8-Bit to 12-Bit Conversion Techniques

To obtain 8 to 12-bit resolution and accuracy, use a feed-forward conversion technique. Two A/D converters will be needed to convert up to 11 bits; three A/D converters to convert 12 bits. The high speed of the CA3300 allows 12-bit conversions in the 500 to 900-ns range.

The circuit diagram of a high-speed 12-bit A/D converter is shown in Fig. 15. In the feed-forward conversion method two sequential conversions are made. Converter A first does a coarse conversion to 6 bits. The output is applied to a 6-bit D/A converter whose accuracy level is good to 12 bits. The D/A converter output is then subtracted from the input voltage, multiplied by 32, and then converted by a second flash A/D converter, which is connected in a 7-bit configuration. The answers from the first and second conversions are added together with bit 1 of the first conversion overlapping bit 7 of the second conversion.

When using this method, take care that:

- The linearity of the first converter is better than  $\frac{1}{2}$  LSB.
- An offset bias of 1 LSB (1/64) is subtracted from the first conversion since the second converter is unipolar.
- The D/A converter and its reference are accurate to the total number of bits desired for the final conversion (the A/D converter need only be accurate to 6 bits).

The first converter can be offset-biased by adding a 20- $\Omega$  resistor at the bottom of the ladder and increasing the reference voltage by 1 LSB. If a 6.40-voltage reference is used in the system, for example, then the first CA3300 will require a 6.5-V reference.

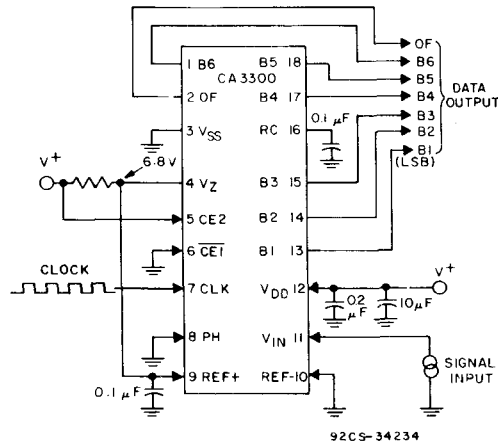

92CS-34234  
Fig. 12 - Typical CA3300 6-bit configuration 15-MHz sampling rate.

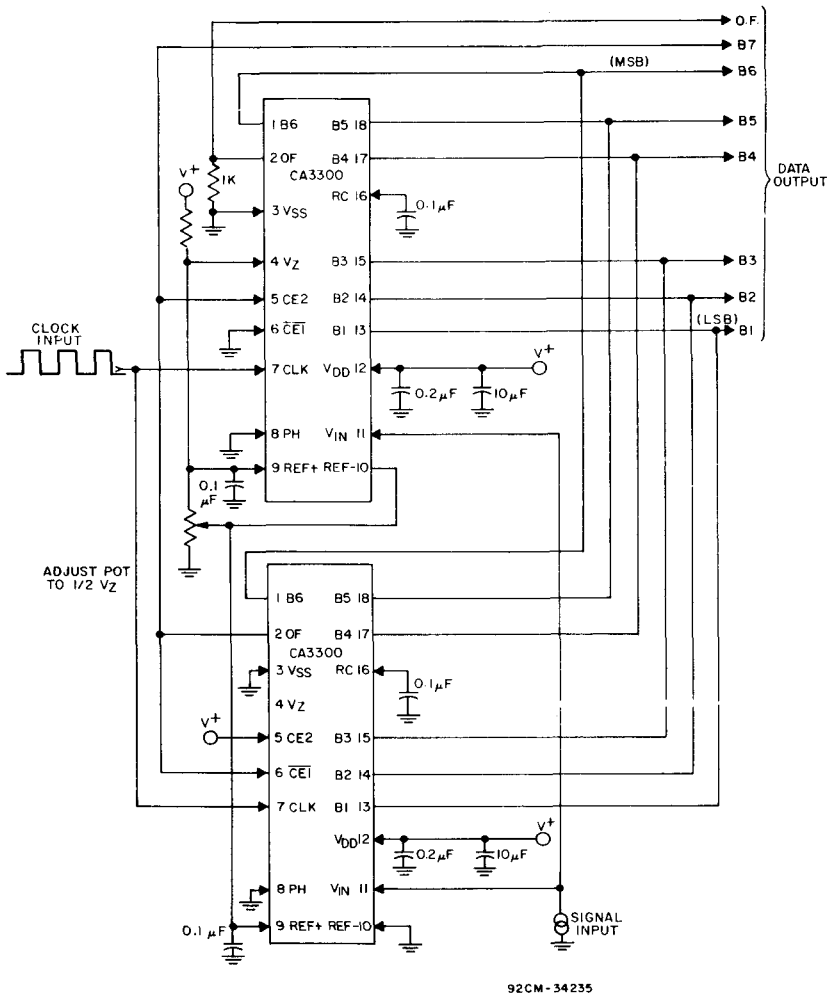

92CM-34235  
Fig. 13 - Typical CA3300 7-bit resolution configuration 15-MHz sampling rate.

# CA3300 Types

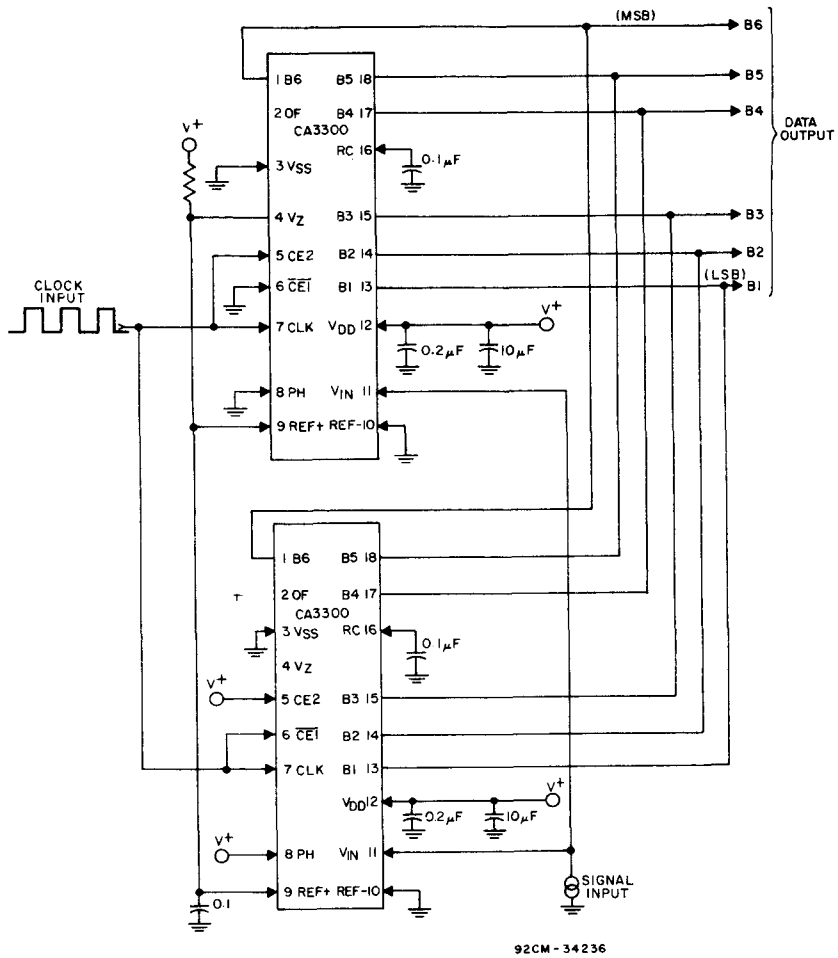

92CM-34236

Fig. 14 - Typical CA3300 6-bit resolution configuration  
30-MHz sampling rate.

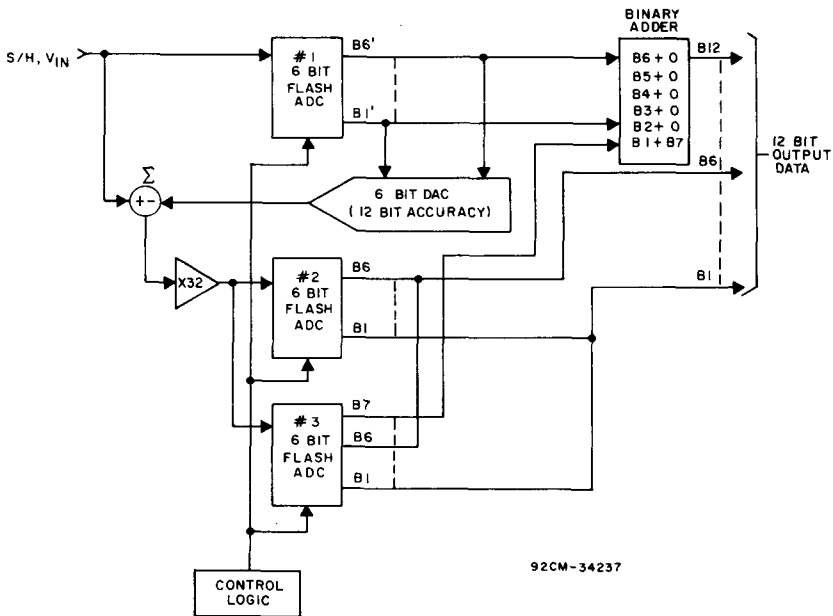

Fig. 15 - Typical CA3300 800-ns 12-bit ADC system.

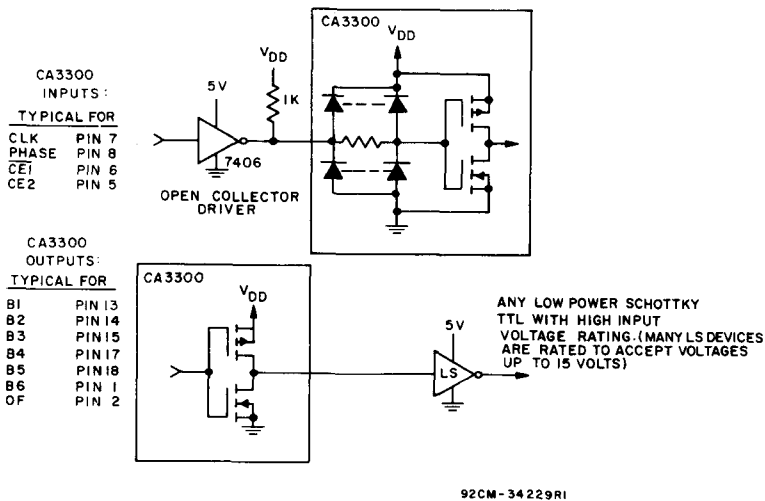

Fig. 16 - TTL interface circuit for  $V_{DD} > 5.5$  volts.

# CA3300 Types

## OUTPUT CODE TABLE

CODE DESCRIPTION	INPUT VOLTAGE*				BINARY OUTPUT CODE (LSB)							DECIMAL COUNT
	V <sub>REF</sub>	V <sub>REF</sub>	V <sub>REF</sub>	V <sub>REF</sub>	0F	B6	B5	B4	B3	B2	B1	
	7.68 (V)	6.40 (V)	5.12 (V)	3.20 (V)								
Zero	0.00	0.00	0.00	0.00	0	0	0	0	0	0	0	0
1 LSB	0.12	0.10	0.08	0.05	0	0	0	0	0	0	1	1
2 LSB	0.24	0.20	0.16	0.10	0	0	0	0	0	1	0	2
"	"	"	"	"	"	"	"	"	"	"	"	"
"	"	"	"	"	"	"	"	"	"	"	"	"
"	"	"	"	"	"	"	"	"	"	"	"	"
½ Full Scale — 1 LSB	3.72	3.10	2.48	1.55	0	0	1	1	1	1	1	31
½ Full Scale	3.84	3.20	2.56	1.60	0	1	0	0	0	0	0	32
½ Full Scale +1 LSB	3.96	3.30	2.64	1.65	0	1	0	0	0	0	1	33
"	"	"	"	"	"	"	"	"	"	"	"	"
"	"	"	"	"	"	"	"	"	"	"	"	"
"	"	"	"	"	"	"	"	"	"	"	"	"
Full Scale — 1 LSB	7.44	6.20	4.96	3.10	0	1	1	1	1	1	0	62
Full Scale	7.56	6.30	5.04	3.15	0	1	1	1	1	1	1	63
Overflow	7.68	6.40	5.12	3.20	1	1	1	1	1	1	1	127

\*The voltages listed below are the ideal centers of each output code shown as a function of its associated reference voltage.

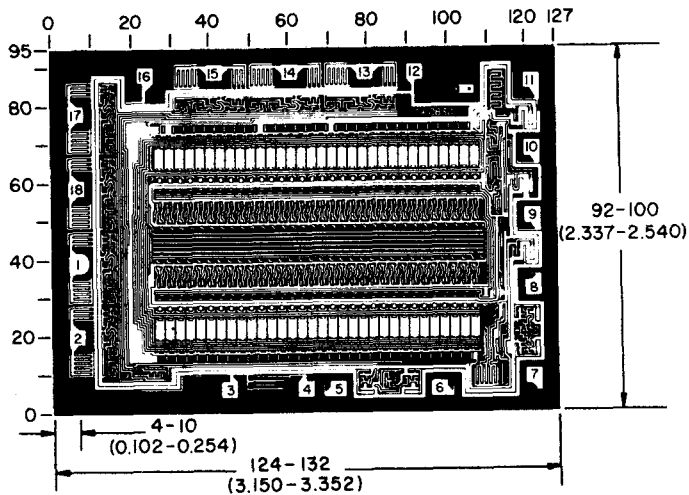

92CM-33324

Dimensions and pad layout for CA3300H.

Dimensions in parentheses are in millimeters and are derived from the basic inch dimensions as indicated. Grid graduations are in mils ( $10^{-3}$  inch).

The photographs and dimensions of each CMOS chip represent a chip when it is part of the wafer. When the wafer is separated into individual chips, the angle of cleavage may vary with respect to the chip face for different chips. The actual dimensions of the isolated chip, therefore, may differ slightly from the nominal dimensions shown. The user should consider a tolerance of  $-3$  mils to  $+16$  mils applicable to the nominal dimensions shown.



## CMOS Video Speed 8-Bit Flash Analog-to-Digital Converter

For Use in Low-Power Consumption, High-Speed Digitization Applications

**Features:**

- CMOS low power with SOS speed
- Parallel conversion technique
- 15-MHz sampling rate (66-ns conversion time)
- 8-bit latched 3-state output with overflow bit
- $\pm 1/2$  LSB accuracy (typ.)
- Single supply voltage (4 to 8 V)
- 2 units in series allow 9-bit output
- 2 units in parallel allow 30-MHz sampling rate

The RCA CA3308\* is a CMOS 200-mW parallel (FLASH) analog-to-digital converter designed for applications demanding both low-power consumption and high-speed digitization.

The CA3308 operates over a wide full-scale input-voltage range of 4 volts up to 8 volts with maximum power consumptions as low as 200 mW, depending upon the clock frequency selected. When operated from a 5-volt supply at a clock frequency of 15 MHz, the power consumption of the CA3308 is less than 150 mW.

The intrinsic high conversion rate makes the CA3308 ideally suited for digitizing high-speed signals. The overflow bit makes possible the connection of two or more CA3308s in series to increase the resolution of the conversion system. A series connection of two CA3308s may be used to produce a 9-bit high-speed converter. Operation of two CA3308s in parallel doubles the conversion speed (i.e., increases the sampling rate from 15 to 30 MHz). CA3308s may be combined with a high-speed 8-bit D/A converter, a binary adder, control logic, and an op amp to form a very high-speed 15-bit A/D converter.

256 paralleled auto-balanced voltage comparators measure the input voltage with respect to a known reference to produce the parallel-bit outputs in the CA3308.

255 comparators are required to quantize all input voltage levels in this 8-bit converter, and the additional comparator is required for the overflow bit.

The voltage supply for analog circuitry is termed  $V_{AA}$  and AGND. The voltage supply for digital circuitry is termed  $V_{DD}$  and  $V_{SS}$ .

The CA3308 type is available in a 24-lead dual-in-line ceramic package (D suffix).

\* Formerly Developmental Type No. TA11279.

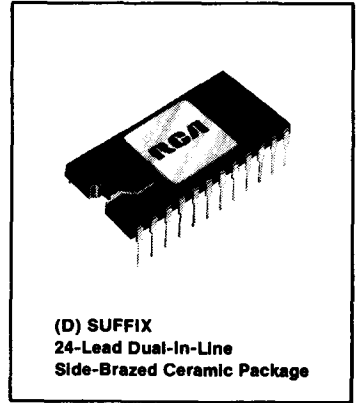

(D) SUFFIX  
24-Lead Dual-In-Line  
Side-Brazed Ceramic Package

**Applications:**

- The CA3308 is especially suited for high-speed conversion applications where low power is also important
- TV video digitizing (industrial/security/broadcast)
- High-speed A/D conversion
- Ultrasound signature analysis
- Transient signal analysis
- High-energy physics research
- High-speed oscilloscope storage/display
- General-purpose hybrid ADCs
- Optical character recognition
- Radar pulse analysis
- Motion signature analysis
- $\mu P$  data acquisition systems

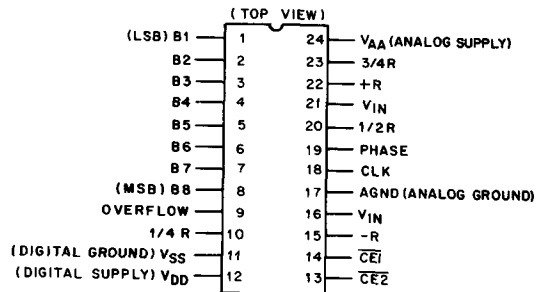

92CS-34789

**TERMINAL ASSIGNMENT**

# CA3308, CA3308A Types

## MAXIMUM RATINGS, Absolute-Maximum Values:

DC SUPPLY VOLTAGE RANGE ( $V_{DD}$ AND $V_{AA}$ ) (VOLTAGE REFERENCED TO $V_{SS}$ TERMINAL) .....	-0.5 to +8 V
INPUT VOLTAGE RANGE ALL INPUTS .....	-0.5 to $V_{DD} + 0.5$ V
DC INPUT CURRENT CLK, PH, CE1, CE2, $V_{IN}$ .....	$\pm 10$ mA
POWER DISSIPATION PER PACKAGE ( $P_D$ ) FOR $T_A = -40$ to $55^\circ\text{C}$ .....	315 mW
FOR $T_A = 55^\circ\text{C}$ to $85^\circ\text{C}$ .....	Derate linearly at 3.3 mW/ $^\circ\text{C}$
TEMPERATURE RANGE OPERATING .....	$-40$ to $+85^\circ\text{C}$
STORAGE .....	$-65$ to $+150^\circ\text{C}$
LEAD TEMPERATURE (DURING SOLDERING) AT DISTANCE $1/16 \pm 1/32$ in. ( $1.59 \pm 0.79$ mm) FROM CASE FOR 10 s MAX. ....	$+265^\circ\text{C}$

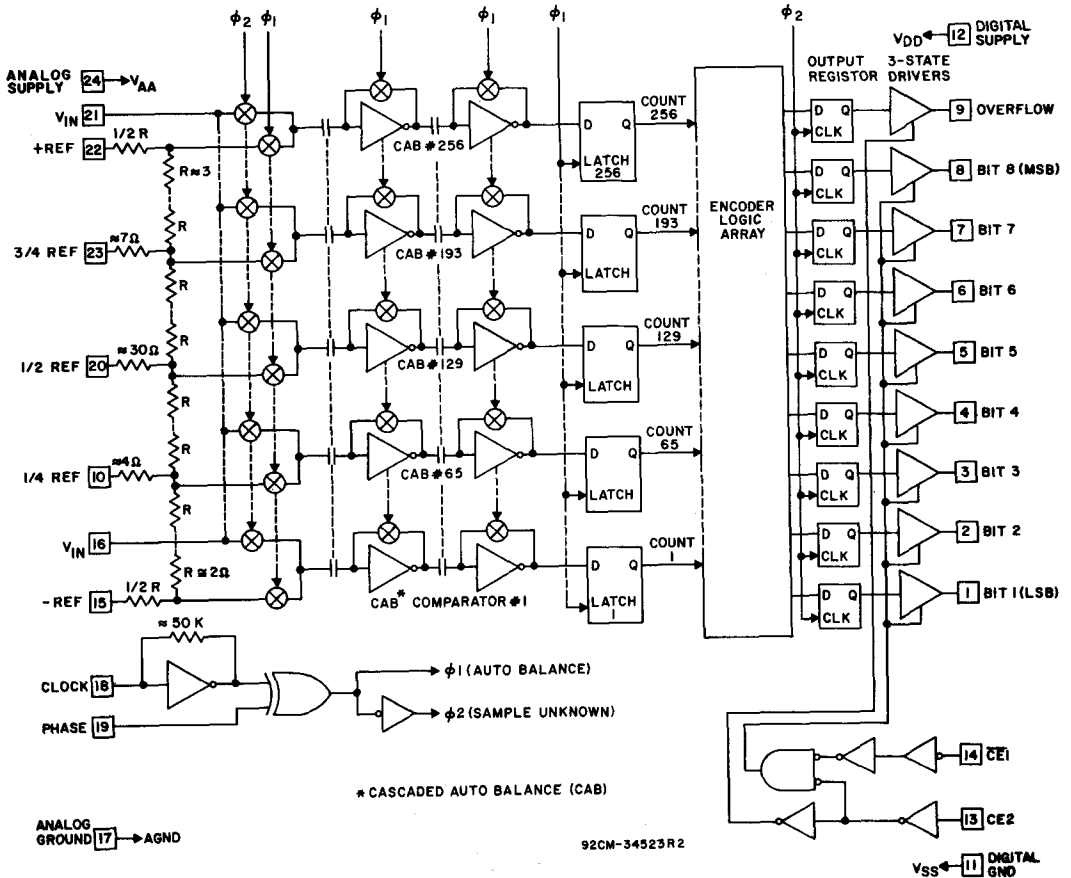

Fig. 1-Block diagram for the CA3308.

# CA3308, CA3308A Types

## ELECTRICAL CHARACTERISTICS

CHARACTERISTIC	TEST CONDITIONS $V_{AA} = V_{DD}$	LIMITS			UNITS
		MIN.	TYP.	MAX.	
Resolution		—	—	8	Bits
Linearity Error	$V_{DD}=5\text{ V}$ , $V_{REF}=6.4\text{ V}$ CLK=15 MHz, gain adjusted	—	—	$\pm 0.5$ $\pm 1$	(CA3308AD) (CA3308D)
Differential Linearity Error	$V_{DD}=5\text{ V}$ , $V_{REF}=6.4\text{ V}$ CLK=15 MHz	—	—	$\pm 0.5$ $\pm 1$	(CA3308AD) (CA3308D)
Quantizing Error		$-\frac{1}{2}$	—	$\frac{1}{2}$	LSB
Analog Input:					
Full Scale Range	$V_{DD}=5\text{ V}$ CLK=15 MHz	4	—	8	V
Input Capacitance		—	50	—	pF
Input Current	$V_{IN}=6.4\text{ V}$	—	1000	2000	$\mu\text{A}$
Maximum Conversion Speed	$V_{DD}=5\text{ V}$	15 M	17 M	—	SPS
Device Current (Excludes $I_{REF}$ )	$V_{DD}=5\text{ V}$ (CLK=15 MHz)	—	50	—	mA
Ladder Impedance		300	600	900	$\Omega$
Digital Inputs:					
Low Voltage		—	—	1.5	V
High Voltage	$V_{DD}=5\text{ V}$	3.5	—	—	V
Input Current (Except Pin 18)		—	$\pm 1$	—	$\mu\text{A}$
Digital Outputs:					
Output Low (Sink) Current	$V_{DD}=5\text{ V}$ , $V_O=0.4\text{ V}$	3.2	10	—	mA
Output High (Source) Current	$V_{DD}=5\text{ V}$ , $V_O=4.6\text{ V}$	1.6	-6	—	mA
Digital Output Delay, $t_d$	$V_{DD}=5\text{ V}$	—	25	—	ns

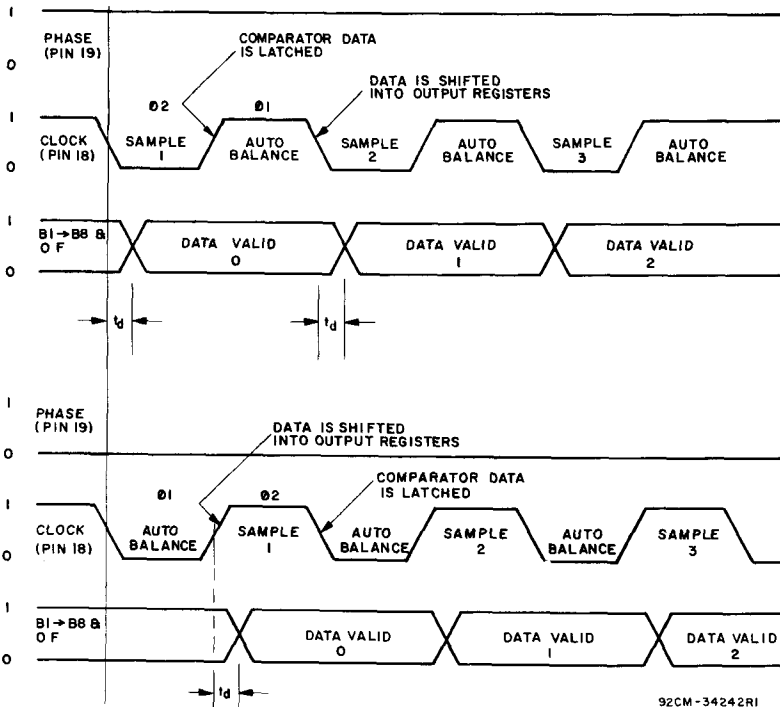
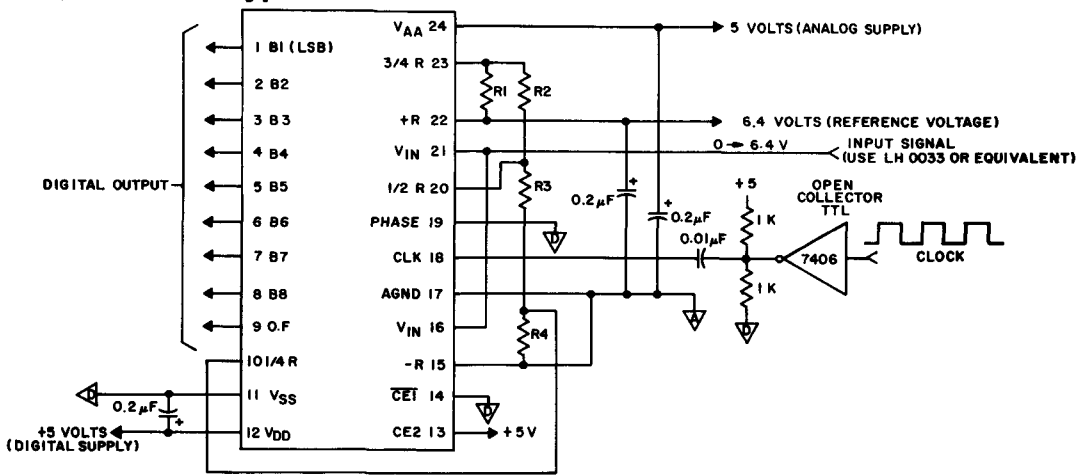

Fig. 2-Timing diagram for the CA3308.

# CA3308, CA3308A Types



**NOTES**

1. R1—R4=100Ω, 0.1% 1/8 WATT (DELETE WHEN USING REFERENCE DRIVER CIRCUIT)
2. A GROUND AND D GROUND MUST BE CONNECTED TO EACH OTHER NEAR THE CHIP.
3. VAA=+6V WILL IMPROVE LINEARITY

92CM-34618R2

Fig. 3—Typical circuit configuration for the CA3308. (15-MHz sampling rate)

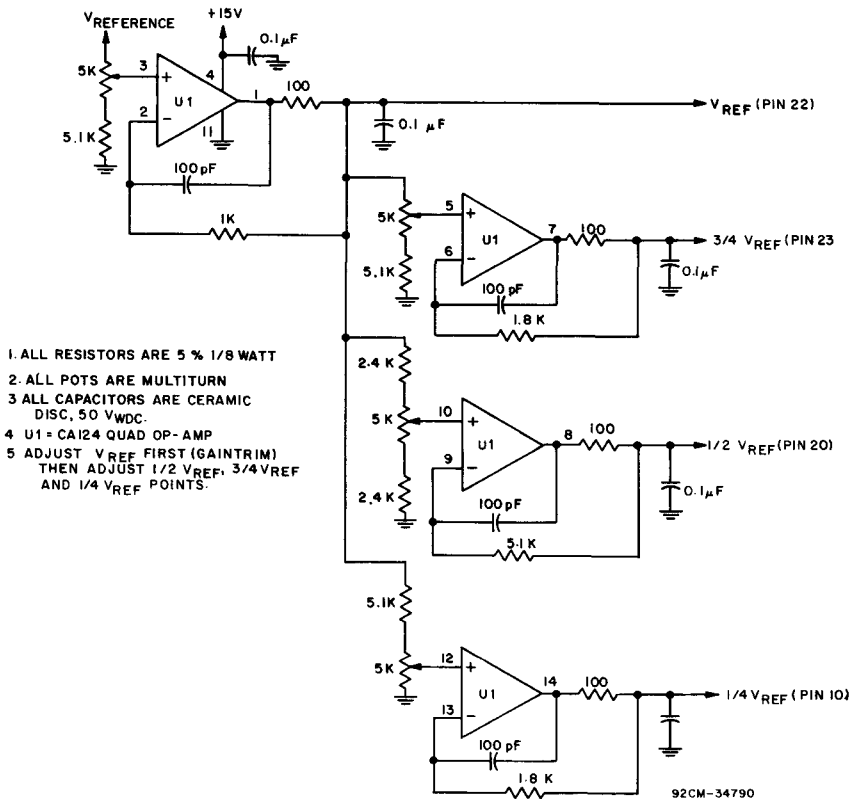

1. ALL RESISTORS ARE 5% 1/8 WATT
2. ALL POTS ARE MULTITURN
3. ALL CAPACITORS ARE CERAMIC DISC, 50 VDC.
4. U1 = CA124 QUAD OP-AMP
5. ADJUST VREF FIRST (GAINTRIM) THEN ADJUST 1/2 VREF, 3/4 VREF AND 1/4 VREF POINTS.

92CM-34790

Fig. 4—Reference driver circuit. (Use for maximum linearity)

## Device Operation

A sequential parallel technique is used by the CA3308 converter to obtain its high-speed operation. The sequence consists of the "Auto Balance" phase,  $\phi 1$ , and the "Sample Unknown" phase  $\phi 2$ . (Refer to the circuit diagram.) Each conversion takes one clock cycle.\* With the phase control (pin 8) high, the "Auto Balance" ( $\phi 1$ ) occurs during the High period of the clock cycle, and the "Sample Unknown" ( $\phi 2$ ) occurs during the low period of the clock cycle.

During the "Auto Balance" phase, a transmission switch is used to connect each of the first set of 256 commutating capacitors to their associated ladder reference tap. Those tap voltages will be as follows:

$$V_{\text{tap}}(N) = \left[ \frac{N}{256} V_{\text{REF}} - \left( \frac{1}{512} \right) V_{\text{REF}} \right] \\ = \left[ \frac{2N-1}{512} \right] V_{\text{REF}}$$

Where:

$V_{\text{tap}}(n)$  = reference ladder tap voltage at point n.

$V_{\text{REF}}$  = voltage across  $-REF$  to  $+REF$

$N$  = tap number (1 through 256)

The other side of these capacitors are connected to single stage amplifiers whose outputs are shorted to their inputs by switches. This balances the amplifiers at their intrinsic trip points, which is approximately,  $V_{DD} - V_{SS}/2$ . The first set of capacitors now charge to their associated tap voltages.

At the same time a second set of commutating capacitors and amplifiers are also auto-balanced. The balancing of the second stage amplifier at its intrinsic trip point removes any tracking differences between the first and second amplifier stages. The cascaded auto-balance (CAB) technique, used here, increases comparator sensitivity and temperature tracking.

In the "Sample Unknown" phase, all ladder tap switches and comparator shorting switches are opened. At the same time  $V_{in}$  is switched to the first set of commutating

\*This device requires only a single phase clock. The terminology of  $\phi 1$  and  $\phi 2$  refers to the High and Low periods of the same clock.

capacitors. Since the other end of the capacitors are now looking into an effectively open circuit, any input voltage that differs from the previous tap voltage will appear as a voltage shift at the comparator amplifiers. All comparators that had tap voltages greater than  $V_{in}$  will go to a "low" state at their outputs. All comparators that had tap voltages lower than  $V_{in}$  will go to a "high" state.

The status of all these comparator amplifiers are ac coupled through the second stage comparator and stored at the end of this phase ( $\phi 2$ ), by a latching amplifier stage. Once latched, the status of the comparators are decoded by a 256 to 9-bit decode array and the results are clocked into a storage register at the rising edge of the next  $\phi 2$ .

A 3-state buffer is used at the output of the 9 storage registers which are controlled by two chip-enable signals. CE1 will independently disable B1 through B8 when it is in a high state. CE2 will independently disable B1 through B8 and the OF buffers when it is in the low state.

To facilitate usage of this device a phase control input is provided which can effectively complement the clock as it enters the chip.

## Continuous Clock Operation

One complete conversion cycle can be traced through the CA3308 via the following steps. (Refer to timing diagram No. 1.) With the phase control in a "low" state, the rising edge of the clock input will start a "sample" phase. During this entire "high" state of the clock, the comparators will track the input voltage and the latches will track the comparator outputs. At the falling edge of the clock, all 256 comparator outputs are captured by the 256 latches. This ends the "sample" phase and starts the "auto balance" phase for the comparators. During this "low" state of the clock the output of the latches propagates through the decode array and a 9-bit code appears at the D inputs of the output registers. On the next rising edge of the clock, this 9-bit code is shifted into the output registers and appears with time delay  $t_d$  as valid data at the output of the 3-state drivers. This also marks the start of a new "sample" phase, thereby repeating the conversion process for this next cycle.

# CD22100 Types

## CMOS 4 x 4 Crosspoint Switch with Control Memory

High-Voltage Types (20-Volt Rating)

The RCA-CD22100 combines a 4 x 4 array of crosspoints (transmission gates) with a 4-line-to-16-line decoder and 16 latch circuits. Any one of the sixteen transmission gates (crosspoints) can be selected by applying the appropriate four line address. The selected transmission gate can be turned on or off by applying a logical one or zero, respectively, to the data input and strobing the strobe input to a logical one. Any number of the transmission gates can be ON simultaneously. When the required operating power is applied to the CD22100, the states of the 16 switches are indeterminate. Therefore, all switches must be turned off

by putting the strobe high and data-in low, and then addressing all switches in succession.

### Features:

- Low ON resistance – 75 Ω typ. at  $V_{DD} = 12\text{ V}$
- "Built-in" control latches
- Large analog signal capability –  $\pm V_{DD}/2$
- 10-MHz switch bandwidth
- Matched switch characteristics  
 $\Delta R_{ON} = 18\Omega$  typ. at  $V_{DD} = 12\text{ V}$
- High linearity – 0.5% distortion (typ.) at  $f = 1\text{ kHz}$ ,  $V_{IN} = 5\text{ V}_{p-p}$ ,  $V_{DD} = 10\text{ V}$ , and  $R_L = 1\text{ k}\Omega$
- Standard CMOS noise immunity
- 100% tested for maximum quiescent current at 20 V

### MAXIMUM RATINGS, Absolute-Maximum Values:

DC SUPPLY-VOLTAGE RANGE, ( $V_{DD}$ ) (Voltages referenced to $V_{SS}$ Terminal)	-0.5 to +20 V
INPUT VOLTAGE RANGE, ALL INPUTS	-0.5 to $V_{DD} + 0.5\text{ V}$
DC INPUT CURRENT, ANY ONE INPUT*	$\pm 10\text{ mA}$
POWER DISSIPATION PER PACKAGE ( $P_D$ ):	
For $T_A = -40$ to $+60^\circ\text{C}$ (PACKAGE TYPE E)	500 mW
For $T_A = +60$ to $+85^\circ\text{C}$ (PACKAGE TYPE E)	Derate Linearly at $12\text{ mW}/^\circ\text{C}$ to 200 mW
For $T_A = -55$ to $+100^\circ\text{C}$ (PACKAGE TYPES D, F)	500 mW
For $T_A = +100$ to $+125^\circ\text{C}$ (PACKAGE TYPES D, F)	Derate Linearly at $12\text{ mW}/^\circ\text{C}$ to 200 mW
DEVICE DISSIPATION PER TRANSMISSION GATE	
FOR $T_A = \text{FULL PACKAGE-TEMPERATURE RANGE (All Package Types)}$	100 mW
OPERATING-TEMPERATURE RANGE ( $T_A$ ):	
PACKAGE TYPES D, F, H	$-55$ to $+125^\circ\text{C}$
PACKAGE TYPE E	$-40$ to $+85^\circ\text{C}$
STORAGE TEMPERATURE RANGE ( $T_{stg}$ )	$-65$ to $+150^\circ\text{C}$
LEAD TEMPERATURE (DURING SOLDERING):	
At distance $1/16 \pm 1/32$ inch ( $1.59 \pm 0.79\text{ mm}$ ) from case for 10 s max.	$+265^\circ\text{C}$

\* Maximum current through transmission gates (switches) = 25 mA.

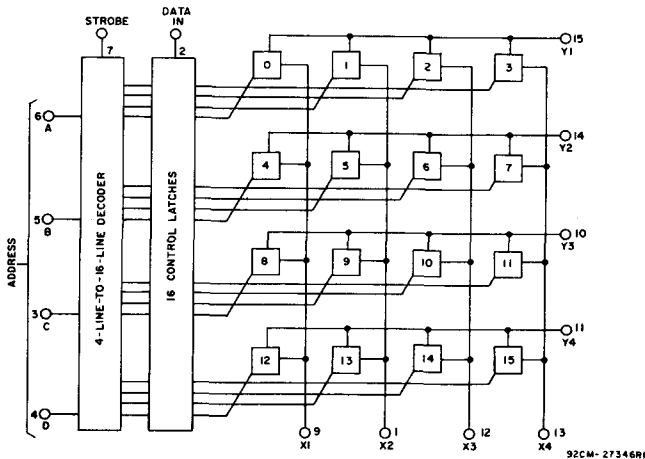
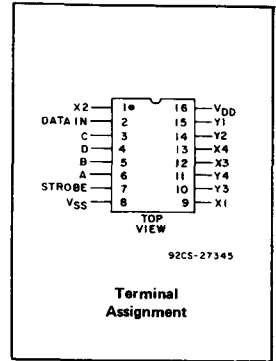

Fig. 1 – Functional diagram.



Terminal Assignment

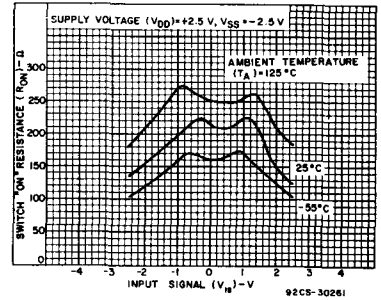

Fig. 2 – Typical ON resistance as a function of input signal voltage at  $V_{DD} = +V_{SS} = 2.5\text{ V}$ .

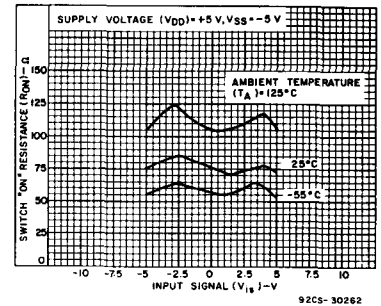

Fig. 3 – Typical ON resistance as a function of input signal voltage at  $V_{DD} = +V_{SS} = 5\text{ V}$ .

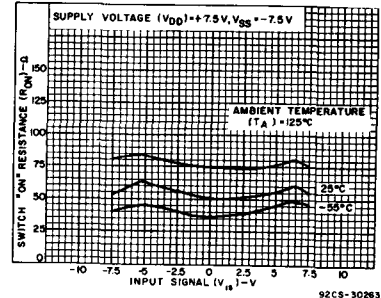

Fig. 4 – Typical ON resistance as a function of input signal voltage at  $V_{DD} = +V_{SS} = 7.5\text{ V}$ .

# CD22100 Types

## RECOMMENDED OPERATING CONDITIONS

For maximum reliability, nominal operating conditions should be selected so that operation is always within the following ranges:

CHARACTERISTIC	LIMITS		UNITS
	MIN.	MAX.	
Supply-Voltage Range (For $T_A =$ Full Package-Temperature Range)	3	18	V

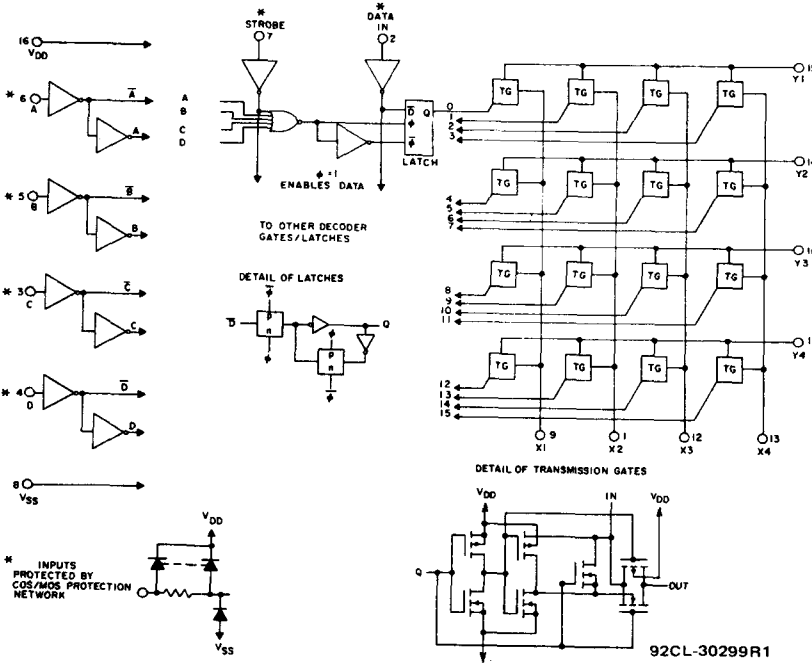

Fig. 6— Schematic diagram.

TRUTH TABLE								
Address		Select	Address		Select			
A	B	C	D	A	B	C	D	
0	0	0	0	X1Y1	0	0	1	X1Y3
1	0	0	0	X2Y1	1	0	1	X2Y3
0	1	0	0	X3Y1	0	1	1	X3Y3
1	1	0	0	X4Y1	1	1	1	X4Y3
0	0	1	0	X1Y2	0	0	1	X1Y4
1	0	1	0	X2Y2	1	0	1	X2Y4
0	1	1	0	X3Y2	0	1	1	X3Y4
1	1	1	0	X4Y2	1	1	1	X4Y4

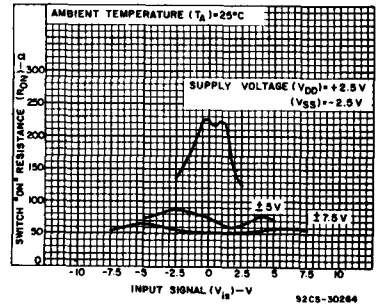

Fig. 5— Typical ON resistance as a function of input signal voltage at  $T_A = 25^\circ\text{C}$ .

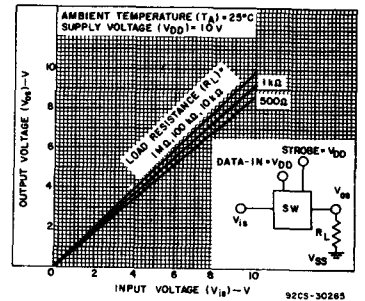

Fig. 7— Typical switch ON transfer characteristics (1 of 16 switches).

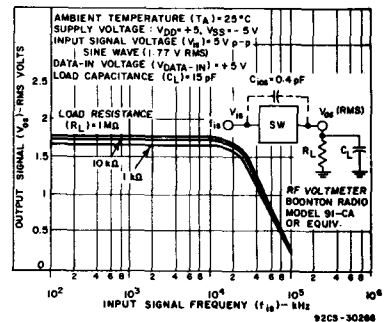

Fig. 8— Typical switch ON frequency response characteristics.

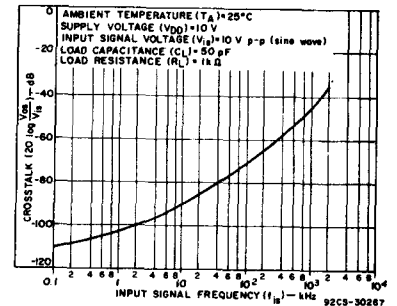

Fig. 9— Typical crosstalk between switches as a function of signal frequency.

# CD22100 Types

## STATIC ELECTRICAL CHARACTERISTICS

CHARACTERISTIC	CONDITIONS	LIMITS at Indicated Temperature (°C)							Units		
		V <sub>IN</sub> (V)	V <sub>DD</sub> (V)	Values at -55,+25,+125, apply to D,F,H pkg				+25			
				-55	-40	+85	+125	Min.		Typ.	Max.
<b>CROSSPOINTS</b>											
Quiescent Device Current, I <sub>DD</sub> Max.	Any Switch	-	5	5	150	150	-	0.04	5	μA	
		-	10	10	300	300	-	0.04	10		
		-	15	20	600	600	-	0.04	20		
		-	20	100	100	3000	3000	-	0.08		100
ON Resistance, R <sub>ON</sub> Max.	Any Switch V <sub>IS</sub> = 0 to V <sub>DD</sub>	-	5	475	500	725	800	-	225	600	Ω
		-	10	135	145	205	230	-	85	180	
		-	12	100	110	155	175	-	75	135	
		-	15	70	75	110	125	-	65	95	
ΔON Resistance, ΔR <sub>ON</sub>	Between any two switches	-	5	-	-	-	-	-	25	-	Ω
		-	10	-	-	-	-	-	10	-	
		-	12	-	-	-	-	-	8	-	
		-	15	-	-	-	-	-	5	-	
OFF Switch Leakage Current I <sub>L</sub> Max.	All switches OFF	0,18	18	±100		±1000		-	±1	±100*	nA
<b>CONTROLS</b>											
Input Low Voltage V <sub>IL</sub> Max.	OFF switch I <sub>L</sub> < 0.2 μA	-	5	1.5		-		-	1.5	V	
		-	10	3		-		3			
		-	15	4		-		4			
Input High Voltage, V <sub>IH</sub> Min.	ON switch see R <sub>ON</sub> characteristic	-	5	3.5		3.5		-	-	V	
		-	10	7		7		-	-		
		-	15	11		11		-	-		
Input Current, I <sub>IN</sub> Max.	Any control	0,18	18	±0.1	±0.1	±1	±1	-	±10 <sup>-5</sup>	±0.1	μA

\* Determined by minimum feasible leakage measurement for automatic testing.

## DYNAMIC ELECTRICAL CHARACTERISTICS at T<sub>A</sub> = 25°C

CHARACTERISTIC	CONDITIONS				LIMITS			UNITS
	f <sub>is</sub> kHz	R <sub>L</sub> kΩ	V <sub>is</sub> * (V)	V <sub>DD</sub> (V)	Min.	Typ.	Max.	
<b>CROSSPOINTS</b>								
Propagation Delay Time, (Switch ON) Signal Input to Output, t <sub>PHL</sub> , t <sub>PLH</sub>	-	10	5	5	-	30	60	ns
	C <sub>L</sub> = 50 pF; t <sub>r</sub> , t <sub>f</sub> = 20 ns				-	15	30	
Frequency Response, (Any Switch ON)	1	1	5	10	-	40	-	MHz
	Sine wave input, 20 log $\frac{V_{os}}{V_{is}} = -3$ dB				-	-	-	
Sine Wave Response, (Distortion)	1	1	5	10	-	0.5	-	%
Feedthrough (All Switches OFF)	1.6	1	5	10	-	-80	-	dB
	Sine wave input				-	-	-	

\*Peak-to-peak voltage symmetrical about  $\frac{V_{DD}}{2}$

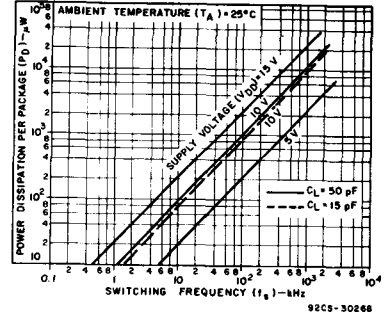

Fig. 10 - Typical dynamic power dissipation as a function of switching frequency.

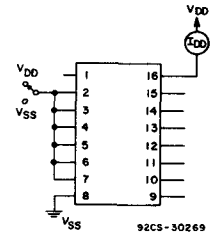

Fig. 11 - Quiescent current test circuit.

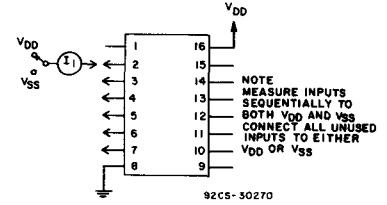

Fig. 12 - Input current test circuit.

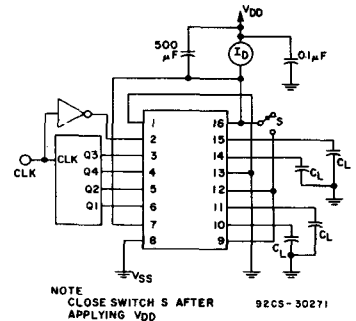

Fig. 13 - Dynamic power dissipation test circuit.



# CD22100 Types

## DYNAMIC ELECTRICAL CHARACTERISTICS at $T_A = 25^\circ\text{C}$

CHARACTERISTIC	CONDITIONS				LIMITS			UNITS
	$f_{is}$ kHz	$R_L$ k $\Omega$	$V_{is}^\bullet$ (V)	$V_{DD}$ (V)	Min.	Typ.	Max.	
<b>CROSSPOINTS (CONT'D)</b>								
Frequency for Signal Crosstalk Attenuation of 40 dB Attenuation of 110 dB	—	1	10	10	—	1.5	—	MHz
	Sine wave input				—	0.1	—	kHz
Capacitance, $X_n$ to Ground $Y_n$ to Ground Feedthrough	—	—	—	5-15	—	18	—	pF
	—	—	—	5-15	—	30	—	
	—	—	—	—	—	0.4	—	
<b>CONTROLS</b>			See Fig.					
Propagation Delay Time: Strobe to Output, $t_{pZH}$ (Switch Turn-ON to High Level)	$R_L=1\text{k}\Omega$ , $C_L=50\text{pF}$ , $t_r, t_f = 20\text{ ns}$	18	5	—	300	600		
		10	10	—	125	250		
		15	15	—	80	160		
Data-In to Output, $t_{pZH}$ (Turn-On to High Level)		19	5	—	110	220	ns	
		10	10	—	40	80		
		15	15	—	25	50		
Address to Output, $t_{pZH}$ (Turn-ON to High Level)		20	5	—	350	700		
		10	10	—	135	270		
		15	15	—	90	180		
Propagation Delay Time: Strobe to Output, $t_{pHZ}$ (Switch Turn-OFF)		18	5	—	165	330		
		10	10	—	85	170		
		15	15	—	70	140		
Data-In to Output, $t_{pZL}$ (Turn-ON to Low Level)		19	5	—	210	420	ns	
		10	10	—	110	220		
		15	15	—	100	200		
Address to Output, $t_{pHZ}$ (Turn-OFF)		20	5	—	435	870		
		10	10	—	210	420		
		15	15	—	160	320		
Minimum Setup Time, Data-In to Strobe, Address, $t_{SU}$		5	5	—	95	190	ns	
		10	10	—	25	50		
		15	15	—	15	30		
Minimum Hold Time, Data-In to Strobe, Address, $t_H$		5	5	—	180	360	ns	
		10	10	—	110	220		
		15	15	—	35	70		
Maximum Switching Frequency, $f_\phi$	$R_L=1\text{k}\Omega$ , $C_L=50\text{ pF}$ $t_r, t_f = 20\text{ ns}$	5	0.6	1.2	—	MHz		
		10	1.6	3.2	—			
		15	2.5	5	—			
Minimum Strobe Pulse Width, $t_W$		5	—	300	600	ns		
		10	—	120	240			
		15	—	90	180			
Control Crosstalk, Data-In, Address, or Strobe to Output	—	10	10	10	—	75	mV (peak)	
	Square wave input $t_r, t_f = 20\text{ ns}$			—	—	—		
Input Capacitance, $C_{IN}$	Any Control Input			—	—	5	7.5	pF

\* Peak-to-peak voltage symmetrical about  $\frac{V_{DD}}{2}$ .

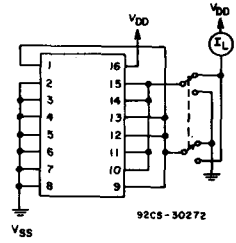

Fig. 14 - OFF switch input or output leakage current test circuit.

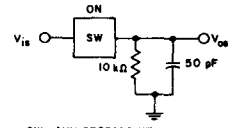

Fig. 15 - Propagation delay time test circuit and waveforms (signal input to signal output, switch ON).

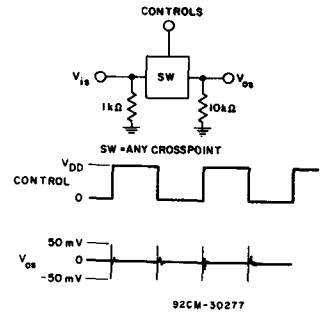

Fig. 16 - Test circuit and waveforms for crosstalk (control input to signal output).

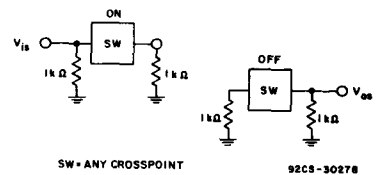

Fig. 17 - Test circuit for crosstalk between switch circuits in the same package.

# CD22100 Types

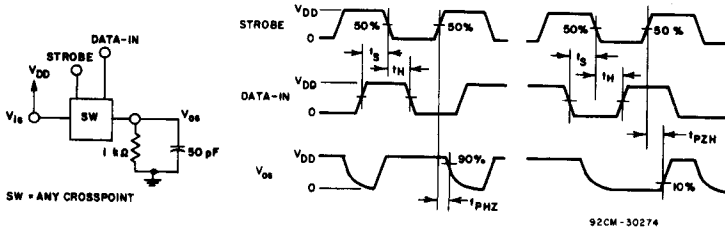

Fig. 18 — Propagation delay time test circuit and waveforms (strobe to signal output, switch Turn-ON or Turn-OFF).

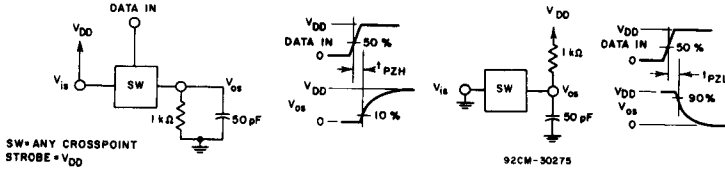

Fig. 19 — Propagation delay time test circuit and waveforms (data-in to signal output, switch Turn-ON to high or low level).

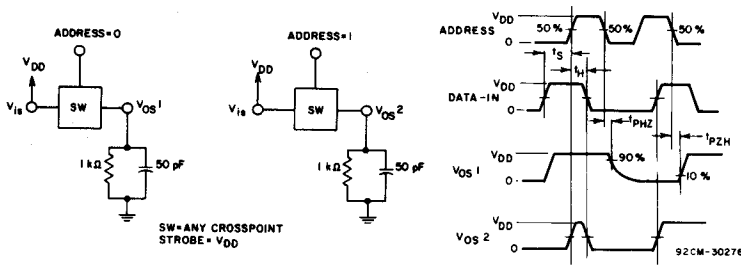
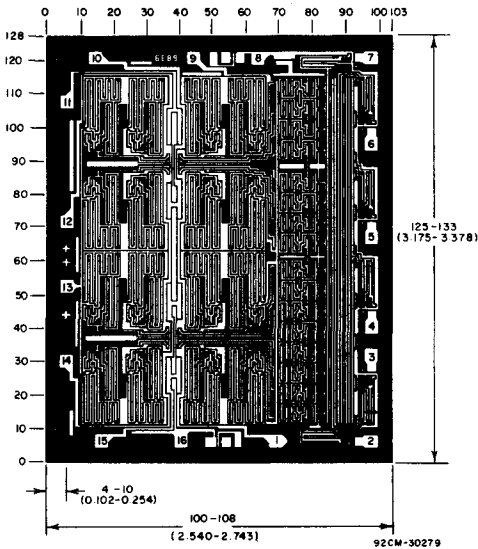

Fig. 20 — Propagation delay time test circuit and waveforms (address to signal output, switch Turn-On or Turn-Off).



Dimensions and pad layout for CD22100H.

Dimensions in parentheses are in millimeters and are derived from the basic inch dimensions as indicated. Grid graduations are in mils (10<sup>-3</sup> inch).

The photographs and dimensions of each CMOS chip represent a chip when it is part of the wafer. When the wafer is separated into individual chips, the angle of cleavage may vary with respect to the chip face for different chips. The actual dimensions of the isolated chip, therefore, may differ slightly from the nominal dimensions shown. The user should consider a tolerance of -3 mils to +16 mils applicable to the nominal dimensions shown.

# CD22101, CD22102 Types

## CMOS 4 x 4 x 2 Crosspoint Switches With Control Memory

The RCA-CD22101 and CD22102 crosspoint switches consist of 4 x 4 x 2 arrays of crosspoints (transmission gates), 4-line to 16-line decoders, and 16 latch circuits. Any one of the sixteen crosspoint pairs can be selected by applying the appropriate four-line address, and any number of crosspoints can be ON simultaneously. Corresponding crosspoints in each array are turned on and off simultaneously, also.

In the CD22101, the selected crosspoint pair can be turned on or off by applying a logical ONE or ZERO, respectively, to the data input, and applying a ONE to the strobe input. When the device is "powered up", the states of the 16 switches are indeterminate. Therefore, all switches must be turned off by putting the strobe high, data-in low, and then addressing all switches in succession.

The selected pair of crosspoints in the CD22102 is turned on by applying a logical ONE to the  $K_A$  (set) input while a logical

### Features:

- Low ON resistance — 75  $\Omega$  typ. at  $V_{DD} = 12$  V
- "Built-in" latched inputs
- Large analog signal capability —  $\pm V_{DD}/2$
- 10 MHz switch bandwidth
- Matched switch characteristics  
 $\Delta R_{ON} = 8 \Omega$  typ. at  $V_{DD} = 12$  V
- High linearity — 0.25% distortion (typ.) at  $f = 1$  kHz,  $V_{IN} = 5$  V<sub>p-p</sub>,  $V_{DD} - V_{SS} = 10$  V, and  $R_I = 1$  k $\Omega$
- Standard CMOS noise immunity

ZERO is on the  $K_B$  input, and turned off by applying a logical ONE to the  $K_B$  (reset) input while a logical ZERO is on the  $K_A$  input. In this respect, the control latches of the CD22102 are similar to SET/RESET flip-flops. They differ, however, in that the simultaneous application of ONEs to the  $K_A$  and  $K_B$  inputs turns off (resets) all crosspoints. All crosspoints in both devices must be turned off as  $V_{DD}$  is applied.

The CD22101 and CD22102 types are supplied in 24-lead hermetic dual-in-line ceramic packages (D and F suffixes), 24-lead dual-in-line plastic packages (E suffix), and in chip form (H suffix).

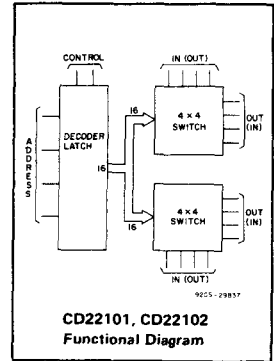

### Applications:

- Telephone systems
- PBX
- Studio audio switching
- Multisystem bus interconnect

### MAXIMUM RATINGS, Absolute-Maximum Values:

DC SUPPLY-VOLTAGE RANGE, ( $V_{DD}$ ) (Voltages referenced to $V_{SS}$ Terminal)	-0.5 to +20 V
INPUT VOLTAGE RANGE, ALL INPUTS	-0.5 to $V_{DD} + 0.5$ V
DC INPUT CURRENT, ANY ONE INPUT*	$\pm 10$ mA
POWER DISSIPATION PER PACKAGE ( $P_D$ ):	
For $T_A = -40$ to $+60^\circ\text{C}$ (PACKAGE TYPE E)	500 mW
For $T_A = +60$ to $+85^\circ\text{C}$ (PACKAGE TYPE E)	Derate Linearly at 12 mW/ $^\circ\text{C}$ to 200 mW
For $T_A = -55$ to $+100^\circ\text{C}$ (PACKAGE TYPES D, F)	500 mW
For $T_A = +100$ to $+125^\circ\text{C}$ (PACKAGE TYPES D, F)	Derate Linearly at 12 mW/ $^\circ\text{C}$ to 200 mW
DEVICE DISSIPATION PER OUTPUT TRANSISTOR FOR $T_A =$ FULL PACKAGE-TEMPERATURE RANGE (All Package Types)	100 mW
OPERATING-TEMPERATURE RANGE ( $T_A$ ):	
PACKAGE TYPES D, F, H	-55 to $+125^\circ\text{C}$
PACKAGE TYPE E	-40 to $+85^\circ\text{C}$
STORAGE TEMPERATURE RANGE ( $T_{stg}$ )	-65 to $+150^\circ\text{C}$
LEAD TEMPERATURE (DURING SOLDERING):	
At distance $1/16 \pm 1/32$ inch ( $1.59 \pm 0.79$ mm) from case for 10 s max.	$+265^\circ\text{C}$

\* Maximum current through transmission gates (switches) = 25 mA.

### RECOMMENDED OPERATING CONDITIONS

For maximum reliability, nominal operating conditions should be selected so that operation is always within the following ranges:

CHARACTERISTIC	LIMITS		UNITS
	Min.	Max.	
Supply-Voltage Range (For $T_A =$ Full Package-Temperature Range)	3	18	V

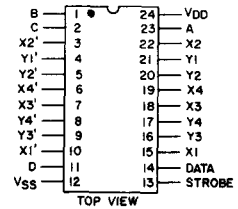

CD22101 Terminal Diagram

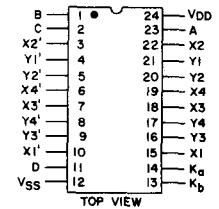

CD22102 Terminal Diagram

# CD22101, CD22102 Types

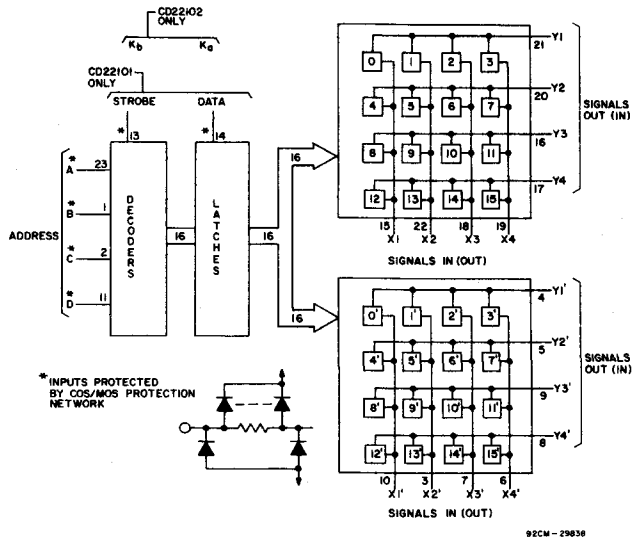

Fig. 1 - Functional block diagram.

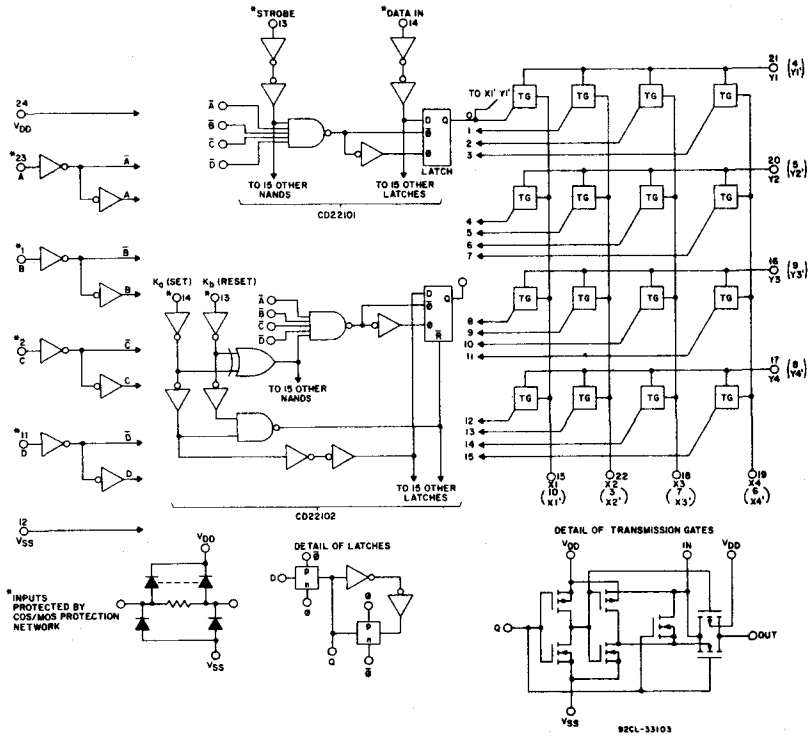

Fig. 2 - Logic diagram.

# CD22101, CD22102 Types

DECODER TRUTH TABLE

Address				Select	Address				Select
A	B	C	D		A	B	C	D	
0	0	0	0	X1Y1 & X1'Y1'	0	0	0	1	X1Y3 & X1'Y3'
1	0	0	0	X2Y1 & X2'Y1'	1	0	0	1	X2Y3 & X2'Y3'
0	1	0	0	X3Y1 & X3'Y1'	0	1	0	1	X3Y3 & X3'Y3'
1	1	0	0	X4Y1 & X4'Y1'	1	1	0	1	X4Y3 & X4'Y3'
0	0	1	0	X1Y2 & X1'Y2'	0	0	1	1	X1Y4 & X1'Y4'
1	0	1	0	X2Y2 & X2'Y2'	1	0	1	1	X2Y4 & X2'Y4'
0	1	1	0	X3Y2 & X3'Y2'	0	1	1	1	X3Y4 & X3'Y4'
1	1	1	0	X4Y2 & X4'Y2'	1	1	1	1	X4Y4 & X4'Y4'

CONTROL TRUTH TABLE FOR CD22101

Function	Address				Strobe	Data	Select
	A	B	C	D			
Switch On	1	1	1	1	1	1	15 (X4Y4) & 15' (X4'Y4')
Switch Off	1	1	1	1	1	0	15 (X4Y4) & 15' (X4'Y4')
No Change	X	X	X	X	0	X	X X X X

1 = High Level; 0 = Low Level; X = Don't Care

CONTROL TRUTH TABLE FOR CD22102

Function	Address				K <sub>a</sub>	K <sub>b</sub>	Select
	A	B	C	D			
Switch On	1	1	1	1	1	0	15 (X4Y4) & 15' (X4'Y4')
Switch Off	1	1	1	1	0	1	15 (X4Y4) & 15' (X4'Y4')
All Switches Off#	X	X	X	X	1	1	All
No Change	X	X	X	X	0	0	X X X X

1 = High Level; 0 = Low Level; X = Don't Care

# In the event that K<sub>a</sub> and K<sub>b</sub> are changed from levels 1,1 to 0,0 K<sub>b</sub> should not be allowed to go to 0 before K<sub>a</sub>, otherwise a switch which was off will inadvertently be turned on.

# CD22101, CD22102 Types

## STATIC ELECTRICAL CHARACTERISTICS

CHARACTERISTIC	CONDITIONS	LIMITS at Indicated Temperature (°C)							Units		
		V <sub>IS</sub> (V)	V <sub>DD</sub> (V)	-55	-40	+85	+125	+25			
								Min.	Typ.	Max.	
<b>CROSSPOINTS</b>											
Quiescent Device Current, I <sub>DD</sub> Max.		-	5	5	5	150	150	-	0.04	5	μA
		-	10	10	10	300	300	-	0.04	10	
		-	15	20	20	600	600	-	0.04	20	
		-	20	100	100	3000	3000	-	0.08	100	
ON Resistance R <sub>ON</sub> Max.	Any Switch V <sub>IS</sub> = 0 to V <sub>DD</sub>	-	5	475	500	725	800	-	225	600	Ω
		-	10	135	145	205	230	-	85	180	
		-	12	100	110	155	175	-	75	135	
		-	15	70	75	110	125	-	65	95	
ΔON Resistance, ΔR <sub>ON</sub>	Between any two switches	-	5	-	-	-	-	-	25	-	Ω
		-	10	-	-	-	-	-	10	-	
		-	12	-	-	-	-	-	8	-	
		-	15	-	-	-	-	-	5	-	
OFF Leakage Current I <sub>L</sub> Max.	All switches OFF	0, 18	18	±1000			-	±1	±100*	nA	
<b>CONTROLS</b>											
Input Low Voltage V <sub>IL</sub> Max.	OFF switch I <sub>L</sub> < 0.2 μA;	-	5	1.5			-	-	1.5	V	
		-	10	3			-	-	3		
		-	15	4			-	-	4		
Input High Voltage, V <sub>IH</sub> Min.	ON switch see R <sub>ON</sub> characteristic	-	5	3.5			3.5	-	-	V	
		-	10	7			7	-	-		
		-	15	11			11	-	-		
Input Current, I <sub>IN</sub> Max.	Any control	0, 18	18	±0.1	±0.1	±1	±1	-	±10 <sup>-5</sup>	±0.1	μA

\* Determined by minimum feasible leakage measurement for automatic testing.

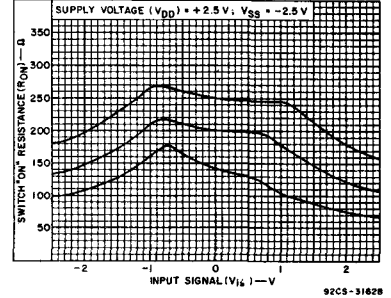

Fig. 3 - Typical ON resistance as a function of input signal voltage at V<sub>DD</sub> = -V<sub>SS</sub> = 2.5 V.

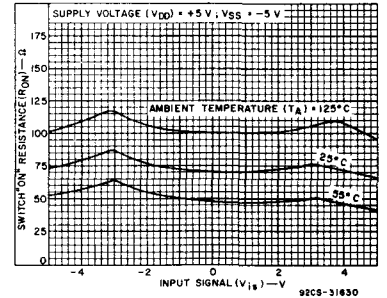

Fig. 4 - Typical ON resistance as a function of input signal voltage at V<sub>DD</sub> = -V<sub>SS</sub> = 5 V.

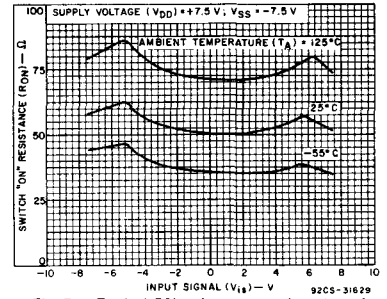

Fig. 5 - Typical ON resistance as a function of input signal voltage at V<sub>DD</sub> = -V<sub>SS</sub> = 7.5 V.

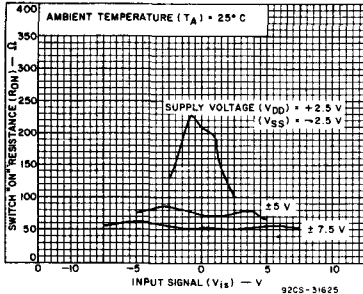

Fig. 6 - Typical ON resistance as a function of input signal voltage at T<sub>A</sub> = 25°C.

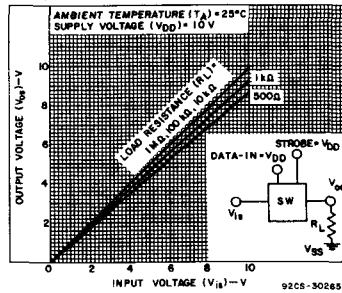

Fig. 7 - Typical switch ON transfer characteristics (1 of 16 switches).

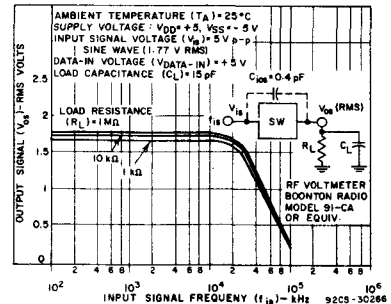

Fig. 8 - Typical switch ON frequency response characteristics.

# CD22101, CD22102 Types

## DYNAMIC ELECTRICAL CHARACTERISTICS at $T_A = 25^\circ\text{C}$

CHARACTERISTIC	CONDITIONS				LIMITS			UNITS
	$f_{is}$ kHz	$R_L$ k $\Omega$	$V_{is}$ <sup>o</sup> (V)	$V_{DD}$ (V)	Min.	Typ.	Max.	
<b>CROSSPOINTS</b>								
Propagation Delay Time, (Switch ON) Signal Input to Output, $t_{pHL}$ , $t_{pLH}$	-	10	5 10 15	5 10 15	-	30 15 10	60 30 20	ns
	$C_L = 50\text{ pF}; t_r, t_f = 20\text{ ns}$							
Frequency Response, (Any Switch ON)	1	1	5	10	-	40	-	MHz
	Sine wave input, $20 \log \frac{V_{os}}{V_{is}} = -3\text{ dB}$							
Sine Wave Response, (Distortion)	1	1	2.5	5	-	1	-	%
	1	1	5	10	-	0.25	-	
	1	1	7.5	15	-	0.15	-	
Feedthrough All Switches OFF (See Fig. 24)	1.6	0.6	2 <sup>■</sup>	10	-	-96	-	dB
	Sine wave input							
Frequency for Signal Crosstalk Attenuation of 40 dB	-	0.6	1 <sup>■</sup>	10	-	2.5	-	MHz
	Sine wave input					0.1		
Capacitance, $X_n$ to Ground $Y_n$ to Ground Feedthrough	-	-	-	-	-	25	-	pF
	-	-	-	-	-	60	-	
	-	-	-	-	-	0.6	-	
<b>CONTROLS</b>								
Propagation Delay Time, High Impedance to High Level or Low Level, $t_{pZH}$ , $t_{pZL}$ Strobe to Output, CD22101	$R_L = 1\text{ k}\Omega$ , $C_L = 50\text{ pF}$ , $t_r, t_f = 20\text{ ns}$			5	-	500	1000	ns
	16	15	-	170	340			
Data-In to Output, CD22101				5	-	515	1000	
	17	10	-	220	440			
$K_a$ to Output, CD22102				5	-	500	1000	
	10	15	-	215	430			
Address to Output, CD22101, CD22102				5	-	480	960	
	18	10	-	225	450			
Propagation Delay Time, High Level or Low Level to High Impedance, $t_{pHZ}$ , $t_{pLZ}$ Strobe to Output, CD22101				5	-	450	900	
	16	15	-	135	270			
$K_b$ to Output, CD22102				5	-	450	900	
	10	15	-	200	400			
Data-In to Output, CD22101				5	-	450	900	
	10	15	-	165	330			
$K_a \cdot K_b$ to Output, CD22102				5	-	280	560	
	10	15	-	130	260			
				15	-	90	180	

<sup>o</sup> Peak-to-peak voltage symmetrical about  $V_{DD}$  unless otherwise specified.

<sup>■</sup> RMS

2

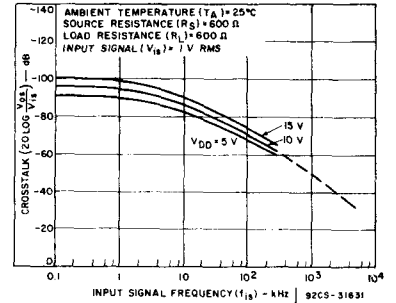

Fig. 9 - Typical crosstalk between switches as a function of signal frequency.

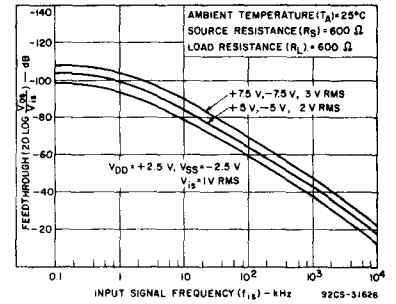

Fig. 10 - Typical feedthrough, any OFF switch as a function of frequency.

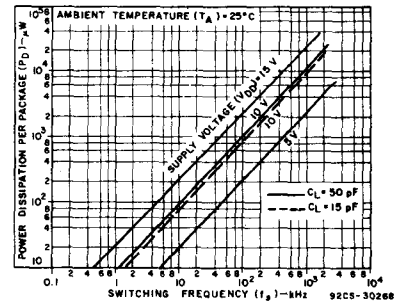
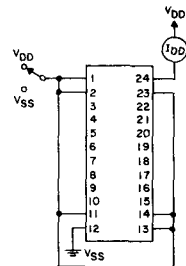

Fig. 11 - Typical dynamic power dissipation as a function of switching frequency for CD22101.



92CS-31627

Fig. 12 - Quiescent current test circuit.

# CD22101, CD22102 Types

DYNAMIC ELECTRICAL CHARACTERISTICS at  $T_A = 25^\circ\text{C}$  (cont'd)

CHARACTERISTIC	CONDITIONS				LIMITS			UNITS
	$f_{is}$ kHz	$R_L$ k $\Omega$	$V_{is}^{\circ}$ (V)	$V_{DD}$ (V)	Min.	Typ.	Max.	
<b>CONTROLS (cont'd)</b>								
Address to Output, CD22101, CD22102		$R_L = 1\text{ k}$ , $C_L = 50\text{ pF}$ , $t_r, t_f = 20\text{ ns}$	See Fig.	5	—	425	850	
				10	—	190	380	
				15	—	130	260	
Minimum Strobe Pulse Width CD22101				5	—	260	500	
				10	—	120	240	
				15	—	80	160	
Address to Strobe Setup or Hold Times, $t_{SU}, t_H$ , CD22101				5	—	-160	0	
				10	—	-70	0	
				15	—	-50	0	
Strobe to Data-In Hold Time, Time, $t_{HHL}; t_{HLH}$ , CD22101				5	—	200	400	ns
				10	—	80	160	
				15	—	60	120	
Address to $K_A$ and $K_B$ Setup or Hold Times, $t_{SU}, t_H$ , CD22102				5	—	-160	0	
				10	—	-70	0	
				15	—	-50	0	
Minimum $K_A \cdot K_B$ Pulse Width, $t_W$ CD22102				5	—	375	750	
				10	—	160	320	
				15	—	110	220	
Minimum $K_A$ Pulse Width, $t_W$ CD22102				5	—	425	850	
				10	—	175	350	
				15	—	120	240	
Minimum $K_B$ Pulse Width, $t_W$ CD22102				5	—	200	400	
				10	—	90	180	
				15	—	70	140	
Control Crosstalk, Data-In, Address, or Strobe to Output,	100	10	21	5	—	75	—	mv (peak)
	Square wave input = 5 V, $t_r, t_f = 20\text{ ns}$ , $R_S = 1\text{ k}\Omega$							
Input Capacitance, $C_{IN}$	Any Control Input			—	—	5	7.5	pF

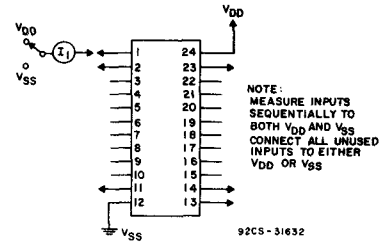
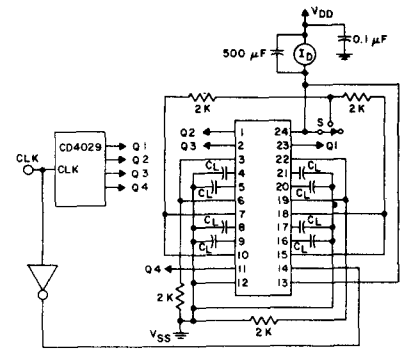

Fig. 13 - Input current test circuit.



NOTE: CLOSE SWITCH S AFTER APPLYING  $V_{DD}$   
Fig. 14 - Dynamic power dissipation test circuit for CD22101.

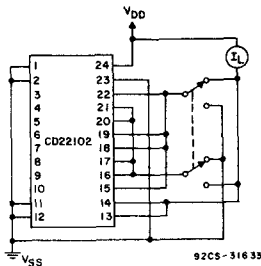

Fig. 15 - OFF switch input or output leakage current test circuit (16 of 32 switches).

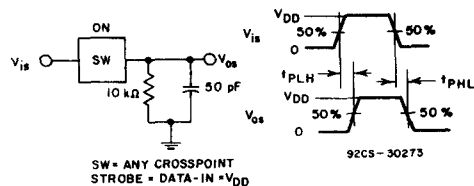

Fig. 16 - Propagation delay time test circuit and waveforms (signal input to signal output, switch ON).



# CD22101, CD22102 Types

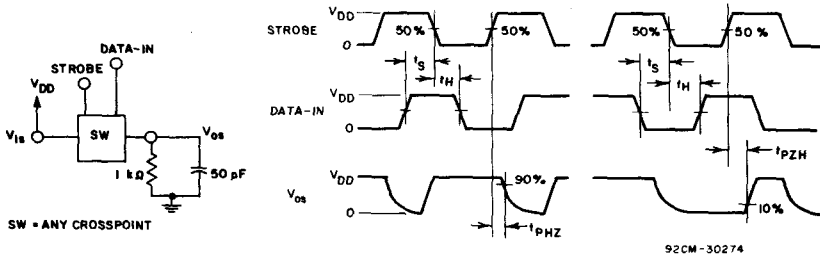

Fig. 17 — Propagation delay time test circuit and waveforms (strobe to signal output, switch Turn-ON or Turn-OFF).

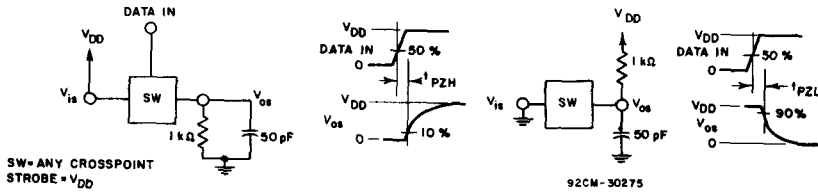

Fig. 18 — Propagation delay time test circuit and waveforms (data-in to signal output, switch Turn-ON to high or low level).

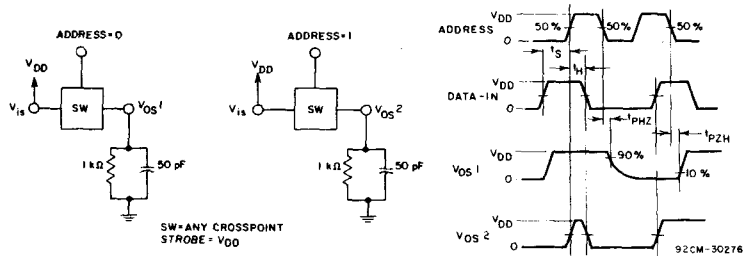
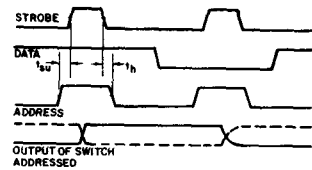

Fig. 19 — Propagation delay time test circuit and waveforms (address to signal output, switch turn-ON or Turn-OFF).



NOTE:  
IF SETUP AND HOLD TIMES PROVIDED ARE TOO SHORT AN UNADDRESSED SWITCH MAY BE TURNED ON OR OFF SIMULTANEOUSLY WITH THE ADDRESSED SWITCH.

92CS-31634

Fig. 20 — Address to strobe setup and hold times.

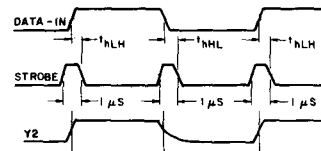

NOTE:  
SET ALL SWITCHES TO OFF INITIALLY. APPLY V<sub>DD</sub> TO ALL X INPUTS AND RETURN ALL Y OUTPUTS TO V<sub>SS</sub> THROUGH 1K. ADDRESS XIY2 (ABCD) WITH f<sub>IN</sub> = 10 MHz

92CS-31635

Fig. 21 — Strobe to Data-In hold time t<sub>H</sub> for CD22101.

# CD22101, CD22102 Types

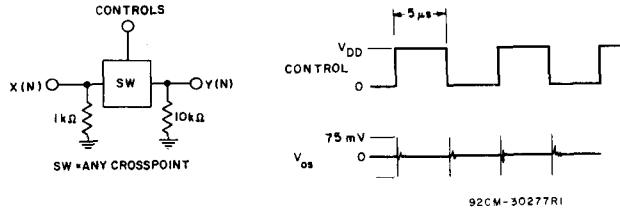

Fig. 22 — Test circuit and waveforms for crosstalk (control input to signal output).

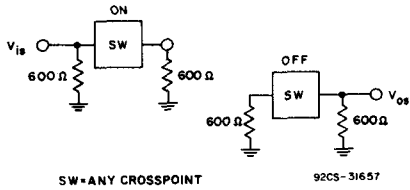

Fig. 23 — Test circuit for crosstalk between switch circuits in the same package.

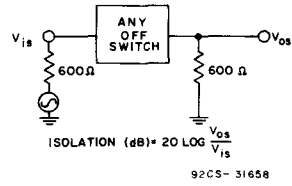
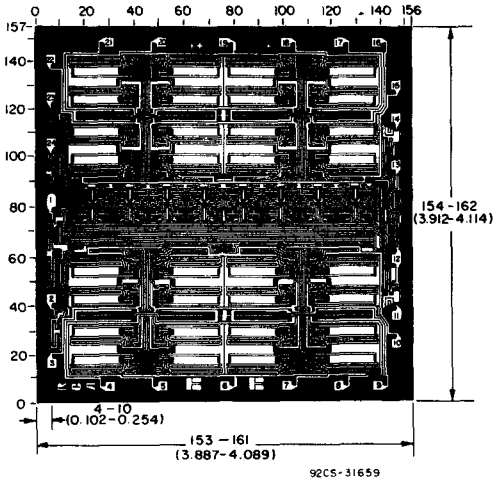
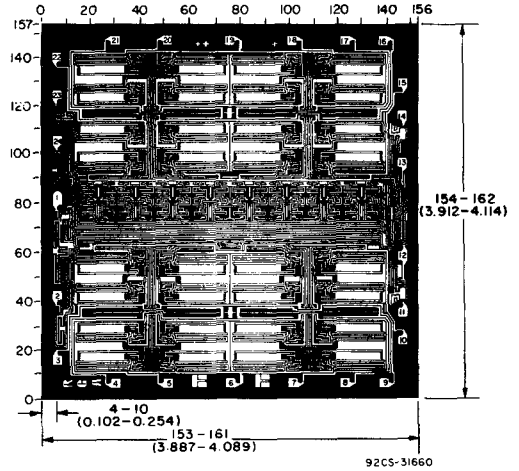

Fig. 24 — Test circuit for feedthrough (any OFF switch).



Dimensions and pad layout for CD22101H.



Dimensions and pad layout for CD22102H.

Dimensions in parentheses are in millimeters and are derived from the basic inch dimensions as indicated. Grid graduations are in mils ( $10^{-3}$  inch).

The photographs and dimensions of each CMOS chip represent a chip when it is part of the wafer. When the wafer is separated into individual chips, the angle of cleavage may vary with respect to the chip face for different chips. The actual dimensions of the isolated chip, therefore, may differ slightly from the nominal dimensions shown. The user should consider a tolerance of -3 mils to +16 mils applicable to the nominal dimensions shown.

# CMOS HDB3 (High Density Bipolar 3) Transcoder for 2.048/8.448 Mb/s Transmission Applications

**Features:**

- HDB3 coding and decoding for data rates from 50 Kb/s to 10 Mb/s in a manner consistent with CCITT G703 recommendations.
- HDB3/AMI transmission coding/reception decoding with code error detection is performed in independent coder and decoder sections.
- All transmitter and receiver inputs/outputs are TTL compatible.
- Internal Loop Test capability.

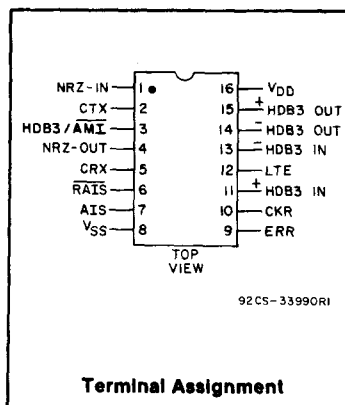

The RCA CD22103 is an LSI SOS integrated circuit which performs the HDB3 transmission coding and reception decoding functions with error detection. It is used in 2.048 and 8.448 Mb/s transmission applications. The CD22103 performs HDB3 coding and decoding for data rates from 50 Kb/s to 10 Mb/s in a manner consistent with CCITT G703 recommendations.

The HDB3 transmitter codes NRZ binary unipolar input signal (NRZ-In) and a synchronous transmission clock (CTX) into two HDB3 binary unipolar RZ output signals (+HDB3 OUT, -HDB3 OUT). The TTL compatible output signals +HDB3 OUT, -HDB3 OUT are externally mixed to generate ternary bipolar HDB3 signals for driving transmission lines.

HDB3 transmission coding/reception decoding with code error detection is performed in independent code and decoder sections. All transmitter and receiver inputs/outputs are TTL compatible.

HDB3 reception decoding is performed on ternary bipolar HDB3 signals which have been externally split to provide binary unipolar receiver input signals, (+HDB3 IN, -HDB3 IN), and a synchronous receiver clock signal, (CRX) into binary unipolar NRZ signals (NRZ - Out).

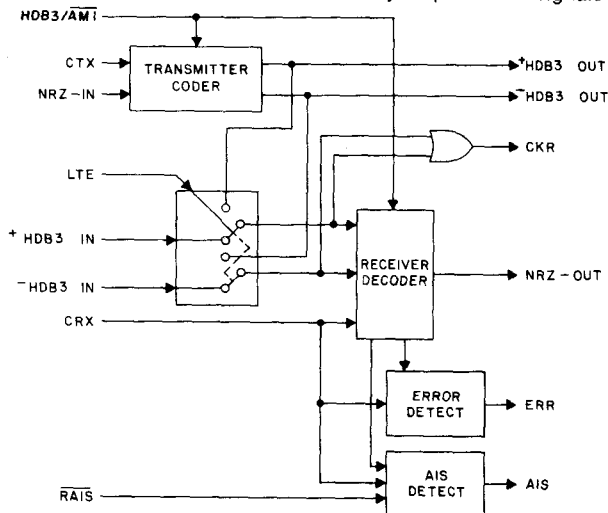

Fig. 1 - Block diagram of the CD22103.

## CD22103 Types

Received signals not consistent with HDB3 coding rules are detected as errors. The receiver error output (ERR) is active high during one CRX period of each bit of received data which is inconsistent with HDB3 coding rules.

An input string consisting of all ones (or marks) is detected and signaled by a high level at the Alarm Signal (AIS) output. The AIS output is set to a high level when less than three zeros are received during two consecutive periods of the Reset Alarm Inhibit Signal (RAIS). The AIS output is subsequently reset to a low level when three or more zeros are received during two periods of the reset signal ( $\overline{\text{RAIS}}$ ).

A diagnostic Loop-Test Mode may be entered by driving the Loop Test Enable Input (LTE) high. In this mode the HDB3 transmitter outputs (+HDB3 OUT, -HDB3 OUT) are internally connected to the HDB3 receiver inputs, and the external HDB3 receiving inputs (+HDB3 IN, -HDB3 IN) are disabled. The NRZ binary output signal (NRZ - Out) corresponds to the NRZ binary input signal (NRZ - In) delayed by approximately 8 clock periods.

The Clock Receiver Output (CKR) is the product of the two HDB3 input signals or-ed together. The CRX clock signal may be derived from the CKR signal with external clock extraction circuitry. In the Loop Test Mode (LTE = 1) CKR is the product of the +HDB3 OUT and -HDB3 OUT signals or-ed together.

The CD22103 may also be used to perform the AMI to NRZ coding/decoding function. To use the CD22103 in this mode, the HDB3/AMI control input is driven low.

The RCA CD22103 operates with a 5 V power supply voltage over the full military temperature range at data rates from 50 Kb/s up to 10 Mb/s.

The RCA CD22103 is similar in function and pin configuration to type MJ1471.

The CD22103 types are supplied in 16-lead hermetic dual-in-line ceramic packages (D suffix), 16-lead dual-in-line plastic packages (E suffix), and in chip form (H suffix).

### MAXIMUM RATINGS, Absolute-Maximum Values:

DC SUPPLY-VOLTAGE RANGE, (V <sub>DD</sub> )	-0.5 to + 8 V
(Voltages referenced to V <sub>SS</sub> Terminal)	
INPUT VOLTAGE RANGE, ALL INPUTS	-0.5 to V <sub>DD</sub> + 0.5 V
DC INPUT CURRENT, ANY ONE INPUT	± 10 mA
POWER DISSIPATION PER PACKAGE (P <sub>D</sub> )	
For T <sub>A</sub> = -40 to + 60° C (PACKAGE TYPE E)	500 mW
For T <sub>A</sub> = + 60 to +85° C (PACKAGE TYPE E)	Derate Linearly at 12 mW/° C to 200 mW
For T <sub>A</sub> = -55 to + 100° C (PACKAGE TYPE D)	500 mW
For T <sub>A</sub> = + 100 to + 125° C (PACKAGE TYPE D)	Derate Linearly at 12 mW/° C to 200 mW
DEVICE DISSIPATION PER OUTPUT TRANSISTOR	
For T <sub>A</sub> = FULL PACKAGE-TEMPERATURE RANGE (All Package Types)	100 mW
OPERATING-TEMPERATURE RANGE (T <sub>A</sub> )	
PACKAGE TYPES D, H	-55 to + 125° C
PACKAGE TYPE E	-40 to + 85° C
STORAGE TEMPERATURE RANGE (T <sub>stg</sub> )	-65 to + 150° C
LEAD TEMPERATURE (DURING SOLDERING):	
At distance 1/16 ± 1/32 inch (1.59 ± 0.79 mm) from case for 10 s max.	+ 265° C

### RECOMMENDED OPERATING CONDITIONS

For maximum reliability, nominal operating conditions should be selected so that operating is always within the following ranges:

CHARACTERISTIC	LIMITS		UNITS
	Min.	Max.	
DC Supply Voltage Range	4.5	5.5	V

STATIC ELECTRICAL CHARACTERISTICS

CHARACTERISTIC	SYMBOL	LIMITS			UNITS
		Min.	Typ.	Max.	
Quiescent Device Current	I <sub>DD</sub>	—	—	100	μA
Operating Device Current f <sub>CL</sub> = 10 MHz		—	—	8	
HDB3 Output Low (Sink) Current (V <sub>OL</sub> = 0.5 V)	I <sub>OL1</sub>	1.6	—	—	mA
HDB3 Output High (Source) Current (V <sub>OH</sub> = 2.8 V)	I <sub>OH1</sub>	-10	—	—	
All Other Outputs Low (Sink) Current (V <sub>OL</sub> = 0.5 V)	I <sub>OL2</sub>	1.6	—	—	
All Other Outputs High (Source) Current (V <sub>OH</sub> = 2.8 V)	I <sub>OH2</sub>	-1.6	—	—	
Input Low Current	I <sub>IL</sub>	—	—	-1	μA
Input High Current	I <sub>IH</sub>	—	—	1	
Input Low Voltage (Max.)	V <sub>IL</sub>	—	—	0.8	V
Input High Voltage (Min.)	V <sub>IH</sub>	2	—	—	
Input Capacitance	C <sub>IN</sub>	—	—	5	pF

DYNAMIC ELECTRICAL CHARACTERISTICS

at T<sub>A</sub> range of -40° C to 85° C for plastic package  
 -55° C to 125° C for ceramic package  
 V<sub>DD</sub> range of 4.5 V to 5.5 V  
 C<sub>L</sub> = 15 pF

CHARACTERISTIC	SYMBOL	LIMITS			UNITS
		Min.	Typ.	Max.	
INPUT					
CTX, CRX Input Frequency	f <sub>CTX</sub> , f <sub>CRX</sub>	.05	—	10	MHz
CTX, CRX Input Rise Time *	t <sub>rcl</sub>	—	—	1	μs
Fall Time *	t <sub>fcl</sub>	—	—	1	μs
NRZ-IN to CTX					
Data Setup Time *	t <sub>s</sub>	—	—	15	ns
Data Hold Time *	t <sub>H</sub>	—	—	15	ns
HDB3 IN to CRX					
Data Setup Time §	t <sub>s</sub>	—	—	55	ns
Data Hold Time *	t <sub>H</sub>	—	—	0	ns
CRX to CKR					
CRX = 8.448 MHz					
Pretrigger °	t <sub>p</sub>	—	—	20	ns
Delay	t <sub>d</sub>	—	—	20	ns

\* See Fig. 4

§ See Fig. 5

° See Fig. 6

# CD22103 Types

## DYNAMIC ELECTRICAL CHARACTERISTICS

at TA range of -40°C to 85°C for plastic package  
 -55°C to 125°C for ceramic package  
 VDD range of 4.5 V to 5.5 V  
 CL = 15 pF

CHARACTERISTIC	SYMBOL	LIMITS			UNITS
		Min.	Typ.	Max.	
OUTPUT					
Transmitter Coder					
CTX to HDB3 OUT:					
Data Propagation Delay Time *	tDD	—	—	90	ns
Handling Delay Time	tHD	—	4	—	clock period
HDB3 OUT Output Pulse Width *					
(Clock duty cycle = 50%)					
fCL = 2.048 MHz	tw	238	—	260	ns
fCL = 8.448 MHz	tw	53	—	65	ns
Receiver Decoder					
CRX to NRZ OUT:					
Data Propagation Delay Times §	tDD	—	—	90	ns
Handling Delay Time # †	tHD	—	4	—	clock period
HDB3 IN to CKR					
HDB3 Propagation Delay Time †					
LTE = 0	tIN CKR	—	—	65	ns
LTE = 1		—	—	30	ns

§ See Fig. 5      \* See Fig. 4      † See Fig. 2      # See Fig. 3

## TRANSCODER OPERATION

### Transmitter Coder (See Fig. 2)

The HDB3/AMI transmitter coder operates on 4 bit serial strings of NRZ binary data and a synchronous transmitter clock (CTX). NRZ binary data is serially clocked into the transmitter on the negative transition of the (CTX) clock.

HDB3/AMI coding is performed on the 4 bit string, and HDB3/AMI binary output data is clocked out to the (+ HDB3 OUT, -HDB3 OUT) outputs on the positive transition of the transmitter clock (CTX) 4 clock pulses after the data appeared at the (NRZ-IN) input.

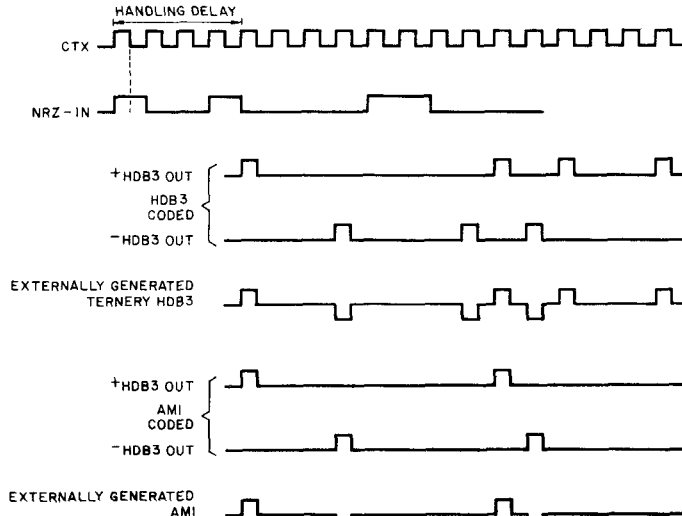

Fig. 2 - Transmitter coder operation timing waveforms - NRZ to HDB3/AMI coding.

92C5-33992

**Receiver Decoder (See Fig. 3)**

The HDB3/AMI receiver decoder operates on 4 bit serial strings of binary coded HDB3/AMI signals, and a synchronous receiver clock (CRX), HDB3/AMI binary data is serially clocked into the receiver on the positive transition

of the (CRX) clock. HDB3/AMI decoding is performed on the 4 bit string, and NRZ binary output data is clocked out to the (NRZ-OUT) output on the positive transition of the receiver clock (CRX) 4 clock pulses after the data appeared at the (+ HDB3 IN, -HDB3 IN) inputs.

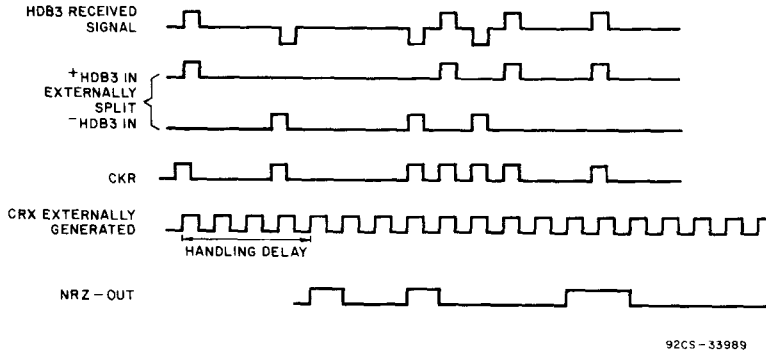

Fig. 3 - Receiver decoder operation timing waveforms - HDB3 to NRZ decoding.

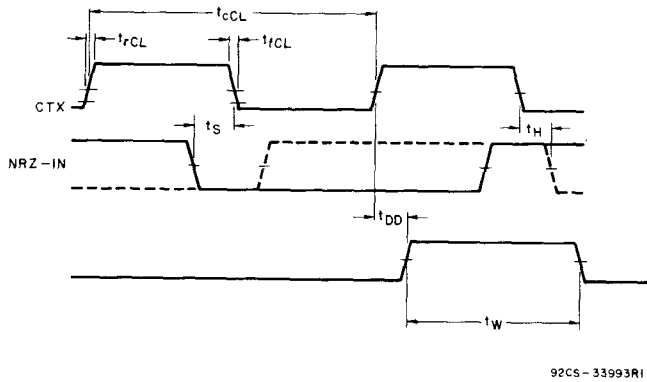

Fig. 4 - Transmitter coder timing waveforms.

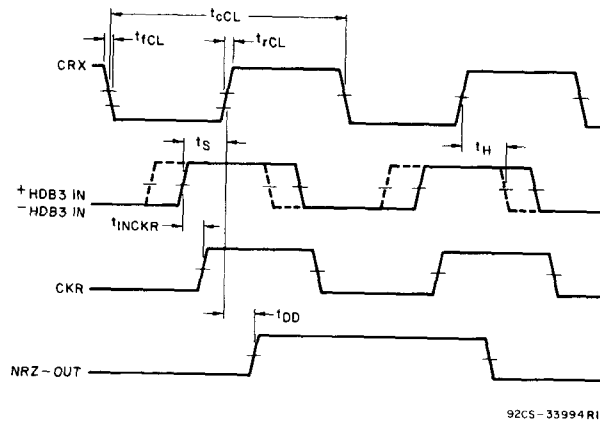
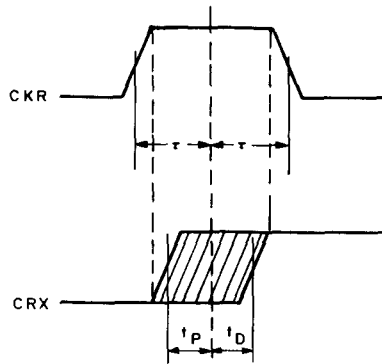

Fig. 5 - Receiver decoder timing waveforms.

## CD22103 Types



92CS-36666

Fig. 6 - CRX Reconstruction Requirements.

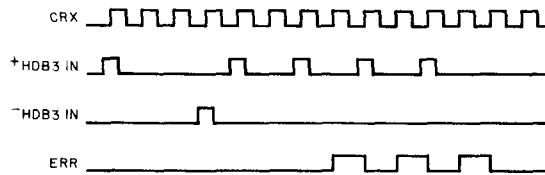

92CS-33995

Fig. 7 - Receiver error-signals timing waveforms.

### Definition of HDB3 Code Used In CD22103 HDB3 Transcoder (As Per CCITT G703 Annex Recommendations) and Error Detection

Coding of a binary signal into an HDB3 signal is done according to the following rules:

1. HDB3 signal is pseudoternary; the three states are denoted B+, B-, and 0.
2. Spaces in the binary signal are coded as spaces in the HDB3 signal. For strings of four spaces, however, special rules apply (See Item 4 below).
3. Marks in the binary signal are coded alternately as B+ and B-in the HDB3 signal (alternate mark inversion). Violations of the rule of alternate mark inversion are introduced when coding strings of four spaces (See Item 4 below).
4. Strings of four spaces in the binary signal are coded according to the following rules:
  - A) The first space of a string is coded as a space if the polarity of the preceding mark of the HDB3 signal has a polarity opposite to the preceding violation and is not a violation by itself; it is coded as a mark, i.e., not a violation (i.e., B+ or B-), if the preceding mark of the HDB3 signal has the same polarity as that of the preceding violation or is by itself a violation.  
This rule ensures that successive violations are of alternate polarity so that no dc component is introduced.
  - B) The second and third spaces of a string are always coded as spaces.
  - C) The last space of a string of four is always coded as a mark, the polarity of which is such that it violates the rule of alternate mark inversion. Such violations are denoted V+ or V- according to their polarity.

The CD22103 is designed to code and decode HDB3 signals which are coded as binary digital signals (NRZ-In) and (+ HDB3 IN, -HDB3 IN), accompanied by sampling clocks (CTX) and (CRX). The two binary coded HDB3 outputs, (+ HDB3 OUT, -HDB3 OUT) may be externally mixed to create the ternary HDB3 signals (See Fig. 2).

The two binary HDB3 input signals have been split from the input ternary HDB3 in an external line receiver.

#### Error Detection

Received HDB3/AMI binary input signals are checked for coding violations, and an error signal (ERR) is generated as described below.

#### HDB3 Signals $HDB3/AMI = High$

The error signal (ERR) is flagged high for one CTX period if a violation pulse ( $\pm V$ ) is received of the same polarity as the last received violation pulse.

A violation pulse ( $\pm V$ ) is considered a reception error and does not cause replacement of the last string of 4 bits to zeros, if:

The received 4 data bits previous to reception of the violation pulse have not been the sequence BX00 (where X = don't care). The error signal (ERR) remains low.

#### NOTES:

The data sequences B000V and BB00V are valid HDB3 codings of the NRZ binary sequence 10000.

The error signal (ERR) count, is the accurate number of all single bit errors.



**AMI Signals HDB3/ $\overline{\text{AMI}}$  = Low**

A coding error (ERR) is signaled when a violation pulse (+V) is received.

**In either the HDB3 or AMI mode:**

When high levels appear simultaneously on both HDB3 inputs (+ HDB3 IN, -HDB3 IN) a logical one is assumed in the HDB3/AMI input stream and the error signal (ERR) goes high.

**Alarm Inhibit Signal**

The alarm output (AIS) is set high if in two successive periods of the external Reset Alarm Signal, ( $\overline{\text{RAIS}}$ ), less than three zeros are received.

The alarm output (AIS) is reset low when three or more zeros are received during two reset alarm signal periods.

# CMOS Four-Digit LCD Decoder-Drivers

## 6-V Rating

### Features

- 6-V supply-voltage rating
- No external components necessary
- 4-digit segment drive capability
- Backplane input/output allows synchronization for cascading devices to drive more digits
- Decodes multiplexed binary to hexadecimal (CD22104) and decimal (CD22104A) outputs

### Applications

- Digital meters and calculators
- General-purpose displays
- Wall and table clocks
- Automobile dashboard displays
- Appliance control panels

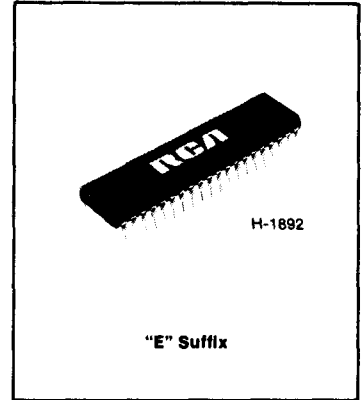

The RCA-CD22104 types are non-multiplexed, four-digit, seven-segment, liquid-crystal display decoder-drivers.

The CD22104 types contain all the circuitry necessary to drive conventional LCD displays (no external components required). Outputs are four sets of seven-segment driver signals and a backplane driver signal. The backplane signal, derived from an on-board free-running oscillator, is common to all four-digit displays.

The backplane and segment drives are designed so that p and n channels have the same ON resistances and thus equal rise and fall times. This equality eliminates any DC component, thereby maximizing display life. In addition to feeding the internal display drivers, the backplane signal can also be used as a master to drive a number of slave devices. The number of slaved devices should be limited to the load that keeps the backplane rise and fall times from exceeding 5  $\mu$ s. If this limit is to be exceeded, the master backplane drivers should be disabled (by connecting pin 36, the oscillator input, to  $V_{SS}$ ) and pin 5 should be fed from an external oscillator and all devices slaved to it. The maximum frequency of the external signal should be 125 Hz at room temperatures.

The on-board oscillator, which operates at 16 kHz when free-running (pin 36 floating), provides a backplane signal whose frequency is approximately 125 Hz. This frequency can be reduced by connecting an external capacitor to pin 36. Plots of backplane frequency vs. supply voltage at various values of external capacitance are shown in Fig. 3. The oscillator may be overdriven by an external signal but care must be taken to keep the lower voltage level above  $V_{SS}$  by at least 20 per cent of  $V_{DD}$  (for  $V_{DD}=5$  V the signal should oscillate between +1 and +5 volts). This precaution prevents the backplane driver from being disabled, a condition that would present a DC component to the LCD display. A signal swinging from rail-to-rail can also be used to overdrive the oscillator but in this case the duty cycle should be such that the lower portion of the signal must be less than one-microsecond duration (the backplane disable sensing circuit will not respond to signals of this duration).

There are four data inputs and four digit-select inputs. The four-bit binary input is decoded by means of a PROM into seven-segment hexadecimal outputs for the CD22104 and into decimal seven-segment display outputs for the CD22104A. These devices are pin-compatible with the Intersil ICM7211IPL and ICM7211AIPL, respectively.

The CD22104 types are supplied in the 40-lead dual-in-line plastic (E suffix) package.

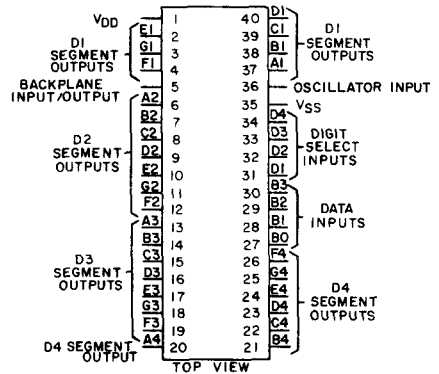

92CS-32933RI

**CD22104, CD22104A  
Terminal Assignment**

**MAXIMUM RATINGS, Absolute-Maximum Values:**

DC SUPPLY-VOLTAGE RANGE, (V <sub>DD</sub> )	-0.3 to +8.5 V
(Voltages referenced to V <sub>SS</sub> Terminal)	-0.3 to V <sub>DD</sub> +0.3 V
INPUT VOLTAGE RANGE, ALL INPUTS	±10 mA
DC INPUT CURRENT, ANY ONE INPUT*	500 mW
POWER DISSIPATION PER PACKAGE (P <sub>D</sub> ):	Derate Linearly at 12 mW/°C to 380 mW
For T <sub>A</sub> =-20 to +60°C	
For T <sub>A</sub> =+60 to +70°C	
DEVICE DISSIPATION PER OUTPUT TRANSISTOR	100 mW
FOR T <sub>A</sub> =FULL PACKAGE-TEMPERATURE RANGE	
OPERATING-TEMPERATURE RANGE (T <sub>A</sub> ):	-20 to +70°C
STORAGE TEMPERATURE RANGE (T <sub>stg</sub> ):	-55 to +125°C
LEAD TEMPERATURE (DURING SOLDERING):	+265°C
At distance 1/16 ± 1/32 in. (1.59 ± 0.79 mm) from case for 10 s max.	

\*Pin 36 limited to ±5 mA.

**STATIC ELECTRICAL CHARACTERISTICS**

T<sub>A</sub>=25°C, V<sub>DD</sub>=5 V, V<sub>SS</sub>=0 V

CHARACTERISTIC	SYMBOL	CONDITIONS	LIMITS			UNITS
			MIN.	TYP.	MAX.	
Operating Supply Voltage Range	V <sub>DD</sub>	V <sub>SS</sub> = 0 V	3	5	6	V
Operating Current	I <sub>OP</sub>	Display Operating	—	10	50	μA
Oscillator Input Current	I <sub>OL</sub> , I <sub>OH</sub>	Pin 36	—	±2	±10	μA
Segment Rise and Fall Time	t <sub>ra</sub> , t <sub>fa</sub>	C <sub>L</sub> = 200 pF	—	0.5	—	μs
Backplane Rise and Fall Time	t <sub>rb</sub> , t <sub>fb</sub>	C <sub>L</sub> = 5000 pF	—	1.5	—	μs
Oscillator Frequency	f <sub>OSC</sub>	Pin 36 Floating	—	16	—	kHz
Backplane Frequency	f <sub>BP</sub>	Pin 36 Floating	—	125	—	Hz
Input High Voltage	V <sub>IH</sub>		3.5	—	—	V
Input Low Voltage	V <sub>IL</sub>		—	—	1.5	V
Input Leakage Current	I <sub>IL</sub>	Pins 27-34	—	±0.01	±1	μA
Input Capacitance	C <sub>I</sub>	Pins 27-34	—	5	—	pF
Backplane Input Leakage	I <sub>IL(BP)</sub>	Pin 5 with Pin 36 @ V <sub>SS</sub>	—	±0.01	±1	μA
Backplane Input Capacitance	C <sub>I(BP)</sub>		—	200	—	pF

**DYNAMIC ELECTRICAL CHARACTERISTICS**

T<sub>A</sub>=25°C, V<sub>DD</sub>=5 V, V<sub>SS</sub>=0 V

CHARACTERISTIC	SYMBOL	CONDITIONS	TYP. VALUES	UNITS
Digit-Select Active Pulse Width	t <sub>sa</sub>	See Timing Diagram	0.5	μs
Data Setup Time	t <sub>ds</sub>	See Timing Diagram	250	ns
Data Hold Time	t <sub>dh</sub>	See Timing Diagram	100	ns
Inter-Digit Select Time	t <sub>ids</sub>	See Timing Diagram	1	μs

# CD22104, CD22104A

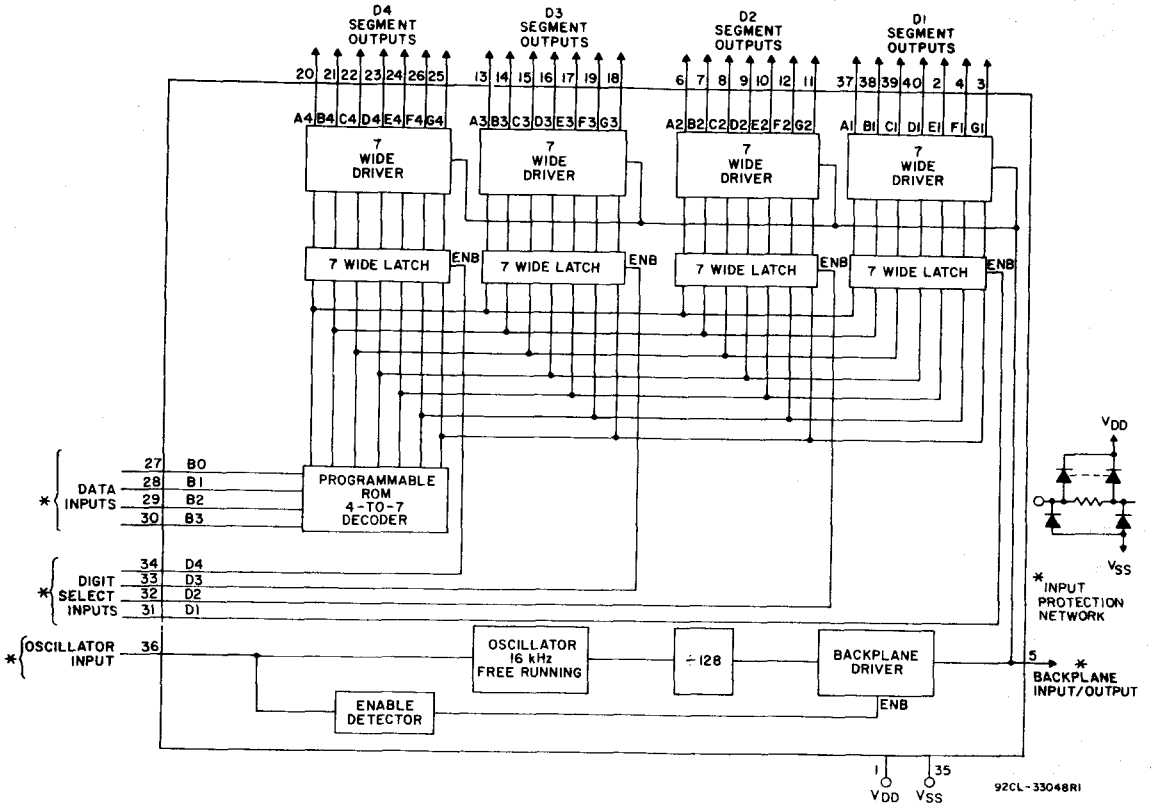

Fig. 1 - Block diagram of CD22104 and CD22104A.

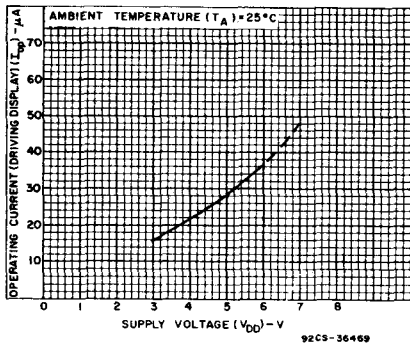

Fig. 2 - Typical operating current as a function of supply voltage.

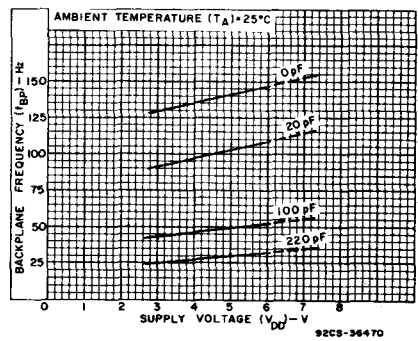

Fig. 3 - Typical backplane frequency as a function of supply voltage and external capacitance on pin 36.

# CD22104, CD22104A

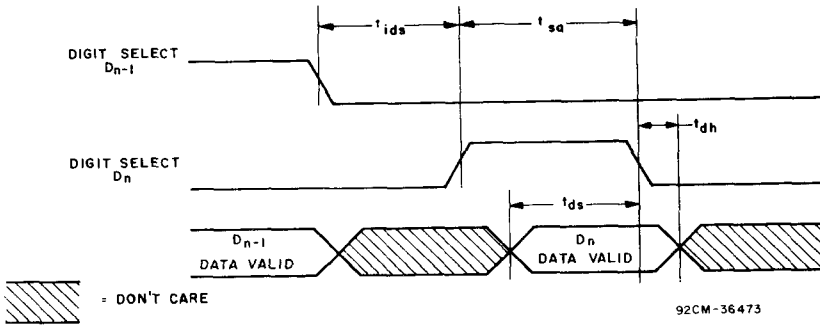

Fig. 4 - CD22104, CD22104A timing diagram.

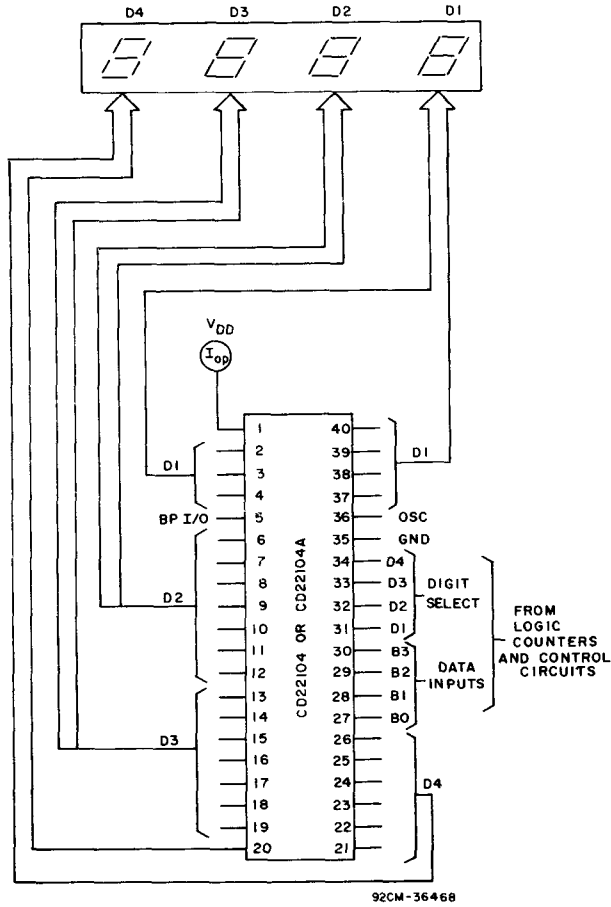

Fig. 5 - Test circuit.

# CD22104, CD22104A

Table 1 — Output Codes

Binary Input B3 B2 B1 B0	Display	
	Hexadecimal	Decimal
	CD22104	CD22104A
0 0 0 0	0	0
0 0 0 1	1	1
0 0 1 0	2	2
0 0 1 1	3	3
0 1 0 0	4	4
0 1 0 1	5	5
0 1 1 0	6	6
0 1 1 1	7	7
1 0 0 0	8	8
1 0 0 1	9	9
1 0 1 0	A	-
1 0 1 1	B	E
1 1 0 0	C	H
1 1 0 1	D	L
1 1 1 0	E	P
1 1 1 1	F	(BLANK)

92CS-33050

DIGIT SELECTION TRUTH TABLE

Pins				Digit Selected
31	32	33	34	
1	0	0	0	D1 (LSD)
0	1	0	0	D2
0	0	1	0	D3
0	0	0	1	D4 (MSD)

DISPLAY SEGMENTS

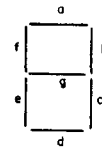

92CS-31376

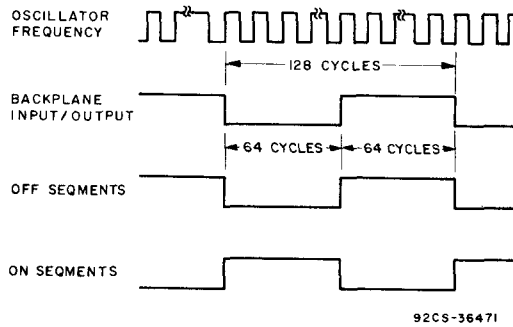

92CS-36471

Fig. 6 - Display waveforms.

# CMOS Four-Digit LCD Decoder-Drivers

6-V Rating

### Features

- 6-V supply-voltage rating
- No external components necessary
- 4-digit segment drive capability
- Backplane input/output allows synchronization for cascading devices to drive more digits
- Direct microprocessor interface
- Decodes binary into hexadecimal (CD22105) and decimal (CD22105A) outputs

### Applications

- Microprocessor-controlled digital meters and calculators
- General-purpose displays
- Microprocessor-controlled automotive dashboard displays
- Microprocessor appliance control panels

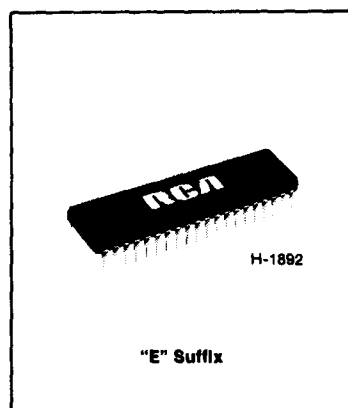

The RCA-CD22105 types are non-multiplexed, four-digit, seven-segment, liquid-crystal display decoder-drivers.

The CD22105 types contain all the circuitry necessary to drive conventional liquid-crystal displays (no external components required). Outputs are four sets of seven-segment driver signals and a backplane driver signal. The backplane signal, derived from an on-board free-running oscillator, is common to all four-digit displays.

The backplane and segment drives are designed so that p and n channels have the same ON resistances and thus equal rise and fall times. This equality eliminates any DC component, thereby maximizing display life. In addition to feeding the internal display drivers, the backplane signal can also be used as a master to drive a number of slave devices. The number of slaved devices should be limited to the load that keeps the backplane rise and fall times from exceeding 5  $\mu$ s. If this limit is to be exceeded, the master backplane drivers should be disabled (by connecting pin 36, the oscillator input, to  $V_{SS}$ ) and pin 5 should be fed from an external oscillator and all devices slaved to it. The maximum frequency of the external signal should be 125 Hz at room temperatures.

The on-board oscillator, which operates at 16 kHz when free-running (pin 36 floating), provides a backplane signal whose frequency is approximately 125 Hz. This frequency can be reduced by connecting an external capacitor to pin 36. Plots of backplane frequency vs. supply voltage at various values of external capacitance are shown in Fig. 3. The oscillator may be overdriven by an external signal but care must be taken to keep the lower voltage level above  $V_{SS}$  by at least 20 per cent of  $V_{DD}$  (for  $V_{DD}=5$  V the signal should oscillate between +1 and +5 volts). This precaution prevents the backplane driver from being disabled, a condition that would present a DC component to the LCD display. A signal swinging from rail-to-rail can also be used to overdrive the oscillator but in this case the duty cycle should be such that the lower portion of the signal must be less than one-microsecond duration (the backplane disable sensing circuit will not respond to signals of this duration).

A four-bit data-input latch and a two-bit select-code latch under the control of two chip-select inputs permit interfacing with a microprocessor. This device simplifies designing a seven-segment display into a microprocessor system, without requiring extensive ROM or CPU time for decoding and display updating. The four-bit binary input is decoded by means of a PROM into a seven-segment hexadecimal output for the CD22105 type and into a decimal display for the CD22105A type. These types are pin-compatible with the Intersil ICM7211MIPL and ICM7211AMIPL, respectively.

The CD22105 types are supplied in the 40-lead dual-in-line plastic (E suffix) package.

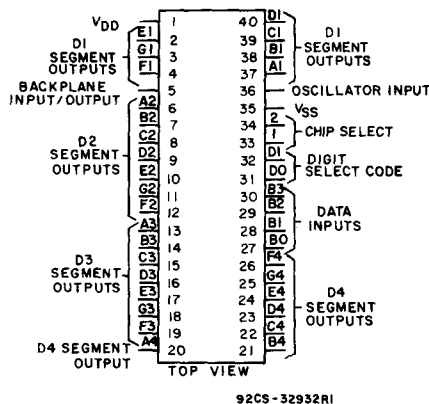

CD22105, CD22105A  
Terminal Assignment

## CD22105, CD22105A

### MAXIMUM RATINGS, Absolute-Maximum Values:

DC SUPPLY-VOLTAGE RANGE, ( $V_{DD}$ ) (Voltages referenced to $V_{SS}$ Terminal) .....	-0.3 to +6.5 V
INPUT VOLTAGE RANGE, ALL INPUTS .....	-0.3 to $V_{DD}$ +0.3 V
DC INPUT CURRENT, ANY ONE INPUT* .....	$\pm 10$ mA
POWER DISSIPATION PER PACKAGE ( $P_D$ ):	
For $T_A = -20$ to $+60^\circ\text{C}$ .....	500 mW
For $T_A = +60$ to $+70^\circ\text{C}$ .....	Derate Linearly at 12 mW/ $^\circ\text{C}$ to 380 mW
DEVICE DISSIPATION PER OUTPUT TRANSISTOR	
FOR $T_A = \text{FULL PACKAGE-TEMPERATURE RANGE}$ .....	100 mW
OPERATING-TEMPERATURE RANGE ( $T_A$ ): .....	-20 to $+70^\circ\text{C}$
STORAGE TEMPERATURE RANGE ( $T_{stg}$ ) .....	-55 to $+125^\circ\text{C}$
LEAD TEMPERATURE (DURING SOLDERING):	
At distance $1/16 \pm 1/32$ in. ( $1.59 \pm 0.79$ mm) from case for 10 s max. ....	$+265^\circ\text{C}$

\*Pin 36 limited to  $\pm 5$  mA.

### STATIC ELECTRICAL CHARACTERISTICS

$T_A = 25^\circ\text{C}$ ,  $V_{DD} = 5$  V,  $V_{SS} = 0$  V

CHARACTERISTIC	SYMBOL	CONDITIONS	LIMITS			UNITS
			MIN.	TYP.	MAX.	
Operating Supply Voltage Range	$V_{DD}$	$V_{SS} = 0$ V	3	5	6	V
Operating Current	$I_{OP}$	Display Operating	—	10	50	$\mu\text{A}$
Oscillator Input Current	$I_{OL}$ , $I_{OH}$	Pin 36	—	$\pm 2$	$\pm 10$	$\mu\text{A}$
Segment Rise and Fall Time	$t_{rs}$ , $t_{fs}$	$C_L = 200$ pF	—	0.5	—	$\mu\text{s}$
Backplane Rise and Fall Time	$t_{rB}$ , $t_{fB}$	$C_L = 5000$ pF	—	1.5	—	$\mu\text{s}$
Oscillator Frequency	$f_{OSC}$	Pin 36 Floating	—	16	—	kHz
Backplane Frequency	$f_{BP}$	Pin 36 Floating	—	125	—	Hz
Input High Voltage	$V_{IH}$		3.5	—	—	V
Input Low Voltage	$V_{IL}$		—	—	1.5	V
Input Leakage Current	$I_{IL}$	Pins 27-34	—	$\pm 0.01$	$\pm 1$	$\mu\text{A}$
Input Capacitance	$C_i$	Pins 27-34	—	5	—	pF
Backplane Input Leakage	$I_{IL(BP)}$	Pin 5 with Pin 36 @ $V_{SS}$	—	$\pm 0.01$	$\pm 1$	$\mu\text{A}$
Backplane Input Capacitance	$C_{i(BP)}$		—	200	—	pF

### DYNAMIC ELECTRICAL CHARACTERISTICS

$T_A = 25^\circ\text{C}$ ,  $V_{DD} = 5$  V,  $V_{SS} = 0$  V

CHARACTERISTIC	SYMBOL	CONDITIONS	TYP. VALUES	UNITS
Chip-Select Active Pulse Width	$t_{CSA}$	See Timing Diagram	100	ns
Data Setup Time	$t_{dSM}$	See Timing Diagram	50	ns
Data Hold Time	$t_{dHM}$	See Timing Diagram	25	ns
Inter-Chip Select Time	$t_{ICS}$	See Timing Diagram	1	$\mu\text{s}$



# CD22105, CD22105A

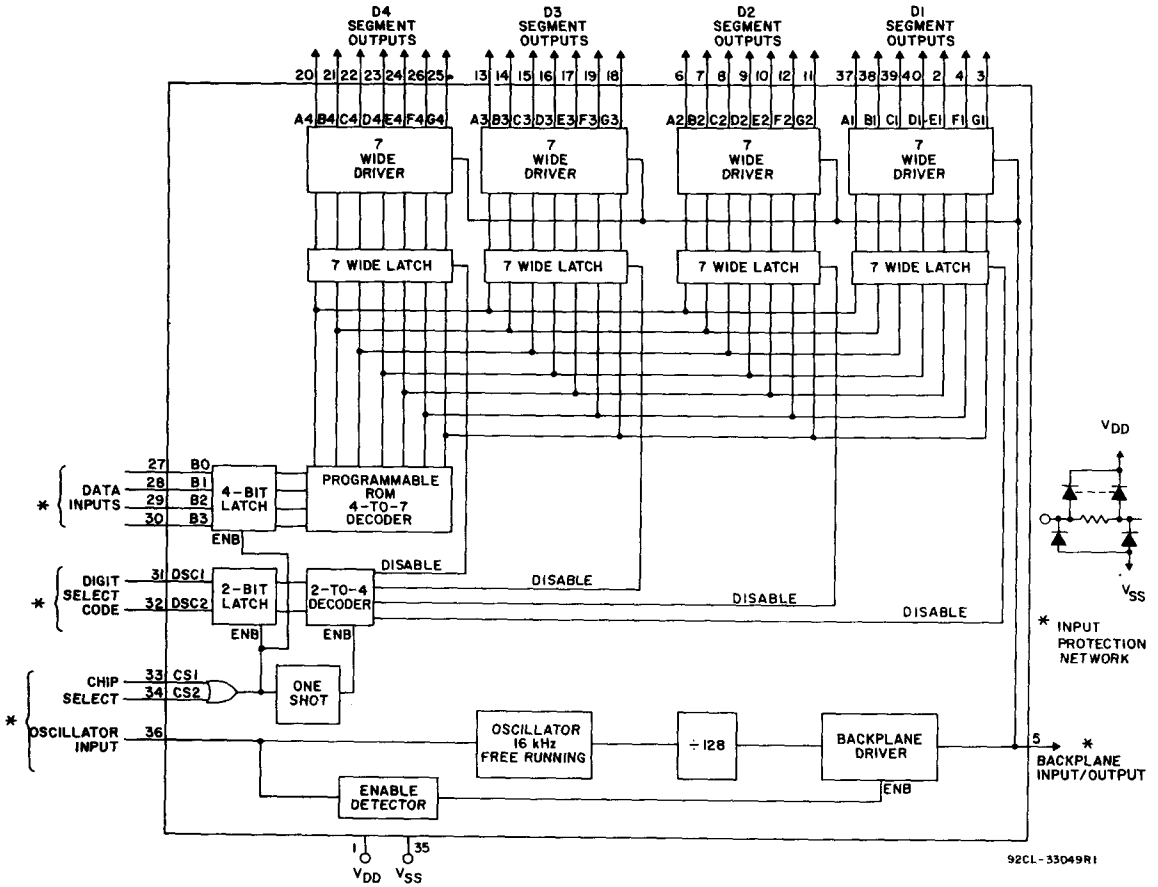

Fig. 1 - Block diagram of CD22105 and CD22105A.

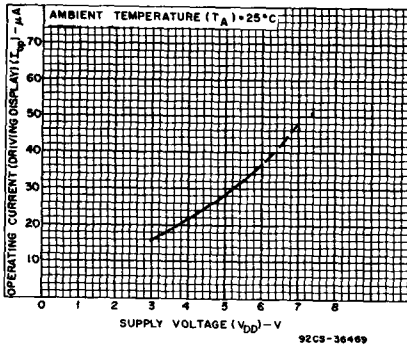

Fig. 2 - Typical operating current as a function of supply voltage.

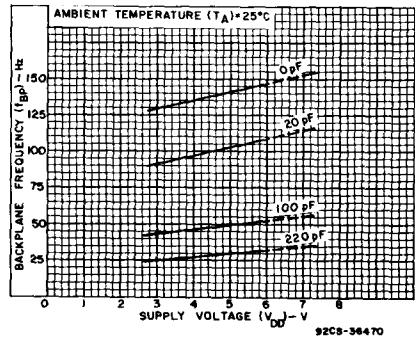

Fig. 3 - Typical backplane frequency as a function of supply voltage and external capacitance on pin 36.

# CD22105, CD22105A

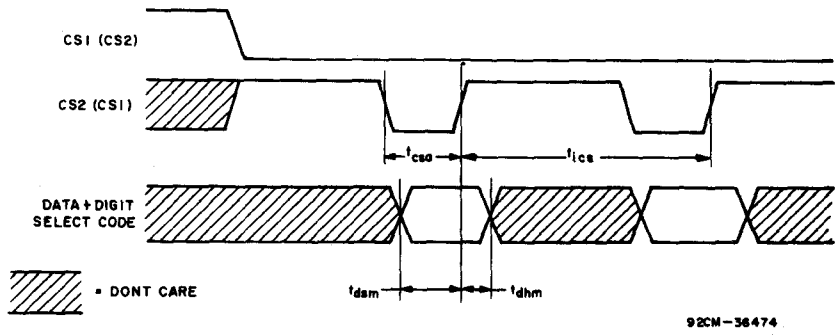

Fig. 4 - CD22105, CD22105A timing diagram.

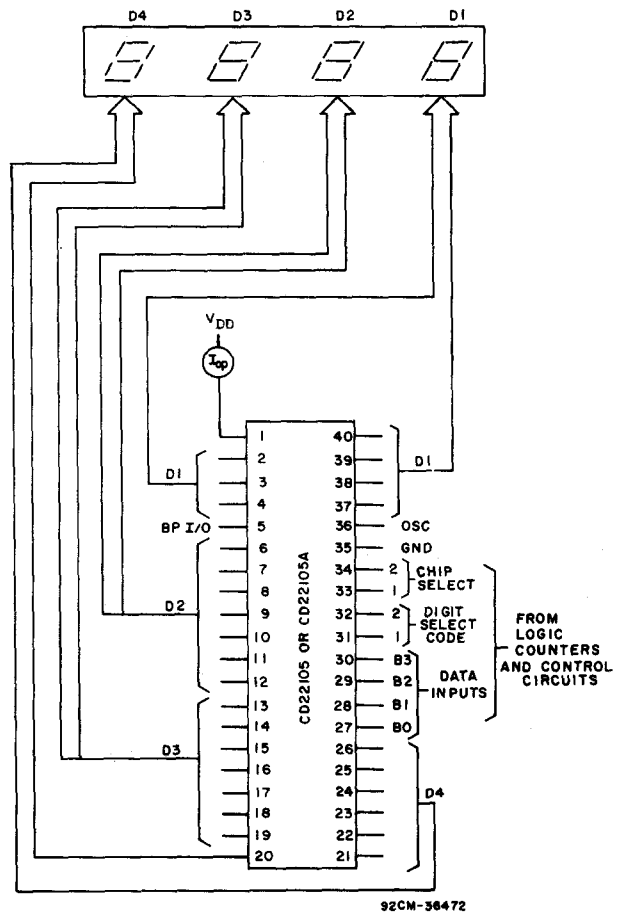

Fig. 5 - Test circuit.

# CD22105, CD22105A

Table 1 — Output Codes

Binary Input B3 B2 B1 B0	Display	
	Hexadecimal CD22105	Decimal CD22105A
0 0 0 0	0	0
0 0 0 1	1	1
0 0 1 0	2	2
0 0 1 1	3	3
0 1 0 0	4	4
0 1 0 1	5	5
0 1 1 0	6	6
0 1 1 1	7	7
1 0 0 0	8	8
1 0 0 1	9	9
1 0 1 0	A	10
1 0 1 1	B	11
1 1 0 0	C	12
1 1 0 1	D	13
1 1 1 0	E	14
1 1 1 1	F	15
	(BLANK)	

92CS-33150

CHIP-SELECT TRUTH TABLE

Pins		Function
33	34	
0	0	New inputs from $\mu P$ are written into input latches
0	1	Inputs from $\mu P$ are latched in input latches, decoded, and passed through selected (1 of 4) output latch to update selected digit
1	0	
1	1	

DIGIT SELECTION TRUTH TABLE

Pins		Digit Selected
31	32	
1	1	D1 (LSD)
0	1	D2
1	0	D3
0	0	D4 (MSD)

## DISPLAY SEGMENTS

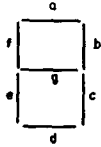

92CS-51376

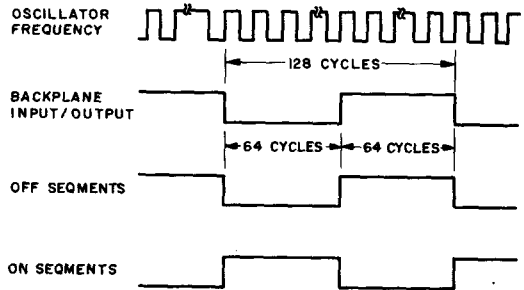

92CS-36471

Fig. 6 - Display waveforms.

# PCM Line Repeater

**Features:**

- Automatic line buildout
- 5.1 V supply voltage
- Buffered output

**Applications:**

- T1 1.544 Mbits/s bipolar carrier system
- T148 2.37 Mbits/s ternary carrier system

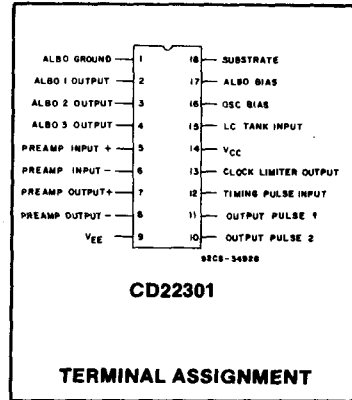

The RCA-CD22301 monolithic PCM repeater circuit is designed for T1 carrier systems operating with a bipolar pulse train of 1.544 Mbits/s. It can also be used in the T148 carrier system operating with a ternary pulse train of 2.37 Mbits/s. The circuit operates from a 5.1 V ± 5 % externally regulated supply.

The CD22301 provides active circuitry to perform all functions of signal equalization and amplification, automatic line buildout (ALBO), threshold detection, clock extraction, pulse timing, and buffered output formation.

The CD22301 is supplied in an 18-lead dual-in-line plastic package (E suffix).

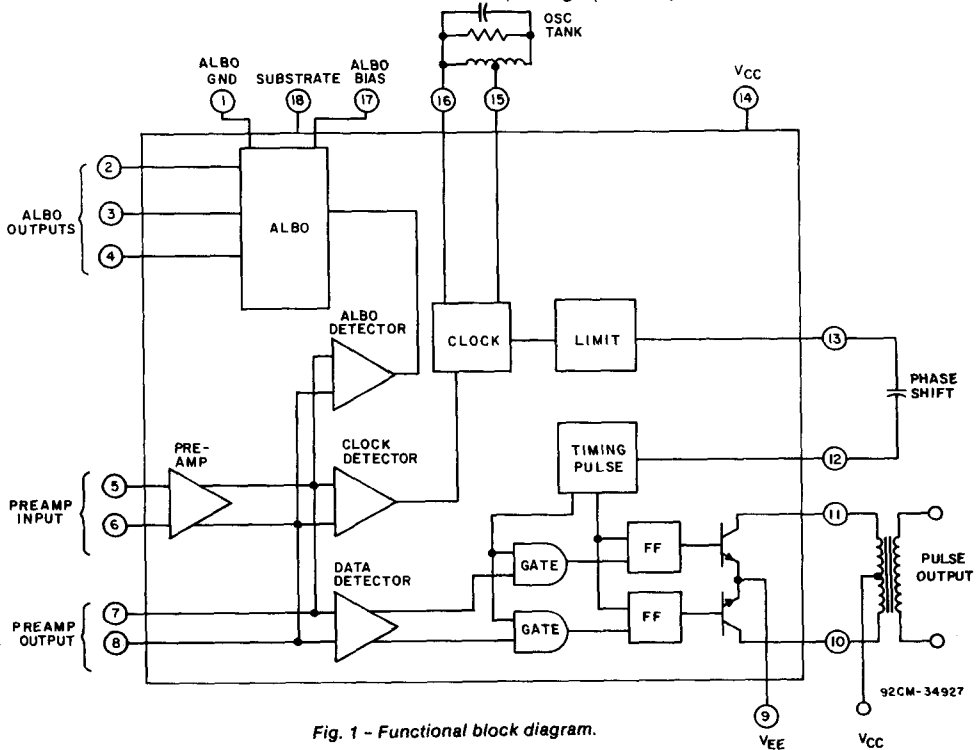

Fig. 1 - Functional block diagram.

**MAXIMUM RATINGS, Absolute Maximum Values:**

At ambient temperature (T<sub>A</sub>) = 25°C

DC SUPPLY .....	10 V
DC CURRENT (Into Pin 9 or 10) .....	25 mA
PEAK CURRENT (Into Pin 9 or 10) .....	100 mA
INPUT SURGE VOLTAGE (Between Pins 5 and 6, t = 10 ms) .....	50 V
OUTPUT SURGE VOLTAGE (Between Pins 10 and 11, t = 1 ms) .....	50 V
POWER DISSIPATION PER PACKAGE (P <sub>d</sub> )	
For T <sub>A</sub> = -40 to +60°C .....	500 mW
For T <sub>A</sub> = +60°C to +85°C .....	Derate linearly at 12 mW/°C to 200 mW
DEVICE DISSIPATION PER OUTPUT TRANSISTOR	
For T <sub>A</sub> = Full Package-Temperature Range .....	100 mW
OPERATING TEMPERATURE RANGE (T <sub>A</sub> ) .....	-40 to +85°C
STORAGE TEMPERATURE (T <sub>stg</sub> ) .....	-65 to +150°C
LEAD TEMPERATURE (DURING SOLDERING)	
At distance 1/16 ± 1/32 inch (1.59 ± 0.79 mm) from case for 10s max. ....	+256°C

**STATIC ELECTRICAL CHARACTERISTICS**

T<sub>A</sub> = 25°C, V<sub>CC</sub> = 5.1 V ± 5% (See Fig. 2)

CHARACTERISTIC	LIMITS			UNITS
	Min.	Typ.	Max.	
<b>DC VOLTAGES</b>				
Pins 2, 3, 4 and 17	—	0	0.1	V
Pins 5, 6, 7 and 8	2.4	2.9	3.4	V
Pins 10 and 11	—	5.1	—	V
Pins 12, 13, 15 and 16	3.1	3.6	4.1	V
<b>DC CURRENTS</b>				
Pin 14	—	22	30	mA
Pins 10 and 11	—	0	100	μA

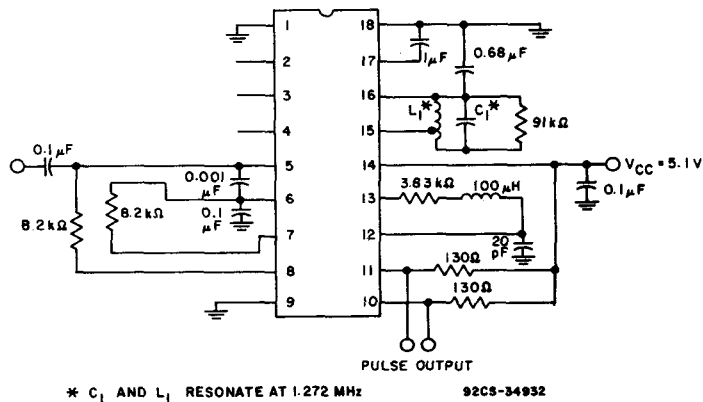

Fig. 2 - DC and output pulse test circuit.

# CD22301

## DYNAMIC ELECTRICAL CHARACTERISTICS

$T_A = 25^\circ\text{C}$ ,  $V_{CC} = 5.1\text{ V} \pm 5\%$

CHARACTERISTIC	SYMBOL	FIG.	NOTE	LIMITS			UNITS
				MIN.	TYP.	MAX.	
Preamplifier Input Impedance	$Z_{in}$	3		20	—	—	$k\Omega$
Preamplifier Output Impedance	$Z_{out}$	3		—	—	2	$k\Omega$
Preamplifier Gain @ 2.37 MHz	$A_o$	3		47	50	—	dB
Preamplifier Output Offset Voltage	$\Delta V_{out}$	3	1	-50	0	50	mV
Clock Limiter Input Impedance	$Z_{in}(CL)$	4	2	10	—	—	$k\Omega$
ALBO Off Impedance	$Z_{ALBO(off)}$	4	3	20	—	—	$k\Omega$
ALBO On Impedance	$Z_{ALBO(on)}$	4	4	—	—	10	$\Omega$
DATA Threshold Voltage	$V_{TH(D)}$	5	5, 8	0.75	0.8	0.85	V
CLOCK Threshold Voltage	$V_{TH(CL)}$	5	6, 8	—	1.12	—	V
ALBO Threshold	$V_{TH(AL)}$	5	7, 8	1.5	1.6	1.7	V
$V_{TH(D)}$ as % of $V_{TH(AL)}$				42	45	49	%
$V_{TH(CL)}$ as % of $V_{TH(AL)}$				65	70	75	%
Buffer Gate Voltage (low)	$V_{OL}$	2	9	0.65	0.8	0.95	V
Differential Buffer Gate Voltage	$\Delta V_{OL}$	2	9	-0.15	0	0.15	V
Output Pulse Rise Time	$t_r$	2, 6	9, 10	—	—	40	ns
Output Pulse Fall Time	$t_f$	2, 6	9, 10	—	—	40	ns
Output Pulse Width	$t_w$	2, 6	9, 10	290	324	340	ns
Pulse Width Differential	$\Delta t_w$	2, 6	9, 10	-10	0	10	ns
Clock Drive Current	$I_{CL}$			—	2	—	mA

### Notes:

1. No signal input. Measure voltage between pins 7 and 8.
2. Measure clock limiter input impedance at pin 15.
3. Adjust potentiometer for 0 volts. Measure ALBO off impedances from pins 2, 3 and 4 to pin 1.
4. Increase potentiometer until voltage at pin 17 = 2 Vdc. Measure ALBO on impedances from pins 2, 3 and 4 to pin 1.
5. Adjust potentiometer for  $\Delta V = 0$  volts. Then slowly increase  $\Delta V$  in the positive direction until pulses are observed at the DATA terminal.
6. Continue increasing  $\Delta V$  until the DC level at the clock terminal drops to 4 volts.
7. Continue increasing  $\Delta V$  until the ALBO terminal rises to 1 volt.
8. Turn potentiometer in the opposite direction and measure negative threshold voltages by repeating tests outlined in notes 5, 6 and 7.
9. Set  $e_{in} = 2.75\text{ mV(rms)}$  at  $f \approx 1.185\text{ MHz}$ . Adjust frequency until maximum amplitude is obtained at pin 15. Observe output pulses at pins 10 and 11.
10. Adjust input signal amplitude until pulses just appear in outputs. Increase input amplitude by three dB.

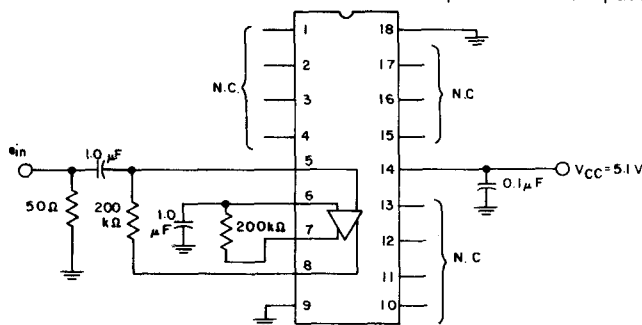

92CS-34929

Fig. 3 - Preamplifier gain and impedance measurement circuit.

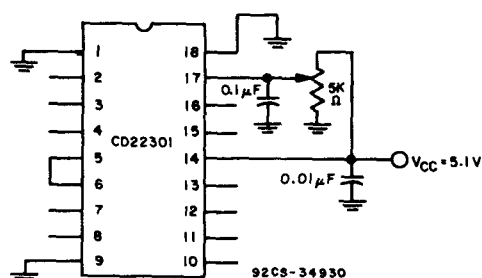

Fig. 4 - Test circuit for impedance measurement.

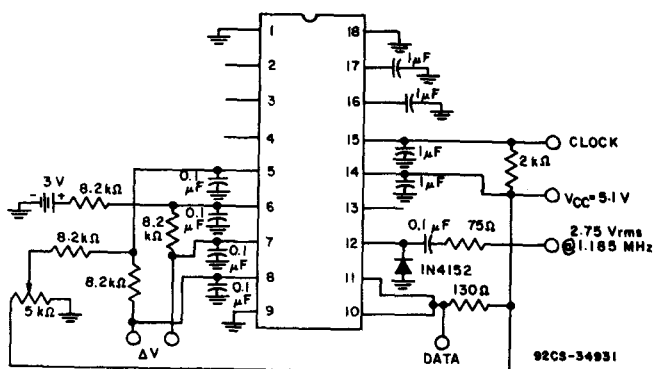

Fig. 5 - Test circuit for threshold voltage measurement.

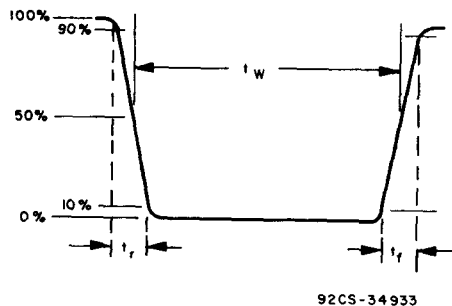
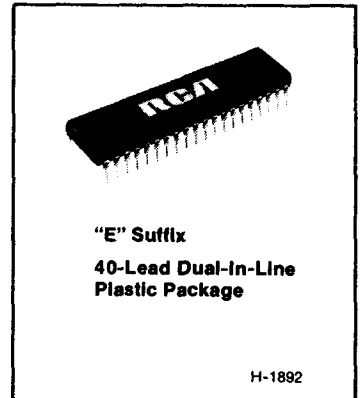

Fig. 6 - Output pulse waveform.

## CMOS 16-Channel Precision Timer/Driver

### Features:

- Provides 17 precision-timed output pulses
- Variable output pulse width as a function of an external timer clock frequency
- High source current drive output pulses- up to 15 mA using bipolar drivers
- Serial data interface via shift register
- EP inputs provide added control logic flexibility for output selection in addition to shift register data
- Static operation- shift register and timers can operate at DC and still retain counts and data levels
- For multiple device use, shift registers can be cascaded
- Provides inherent serial-to-parallel data conversion
- Offers output disable capability using inhibit features
- Low power CMOS logic
- Input/output protection circuitry



The RCA CD22401 is a precision timer/driver. It is an interface circuit and has been designed to provide critically timed output pulses for high-speed printers. The device is fabricated using CMOS enhancement-mode technology with the resulting low power consumption.

The circuit consists of a 16-stage (optionally 17) shift register with each register output connected to a latch and its respective timer and output buffer stage. Thus, there are 17 latches, timers, and driver (output buffer) stages. The output driver pulse width is a function of the timer clock frequency, since it depends upon a fixed count in hardware.

Data is fed serially into the shift register by means of the shift register clock. Then the input sequence is strobed out in parallel to the shift register latch. A particular output is turned on (pulsed high) if the associated latch holds a logic "1" and when the proper enable signal is activated. Simultaneously, the enable signal starts the associated timer which controls the output pulse width. After a time period of 100 negative edges of the clock (99 to 100 clock pulses), the output is turned off. This provides timing accuracy within 1%.

The CD22401 is supplied in the 40-lead dual-in-line plastic package (E suffix) and in chip form (H suffix). It is useful in applications requiring precision pulse widths.

### Register Operation

In operation, a serial string of 16 (17 using the optional flip-flop) bits is fed into the shift register (see Fig. 4 for shift register timing). Ones ("1s") determine an output drive pulse and zeros ("0s") indicate no drive. Any one output enable (EP) line is connected to four selected timers giving the potential for four outputs per one EP pulse with the exception that EP5 connects one timer only. EP lines may be connected to each other.

After a sequence of 16 bits (or 17) is serially loaded into the shift register, a strobe pulse activates the latch so that the register data "word" is transferred out in parallel into the register latch. Here the data waits until an active enable signal combines with a "one" from any latch at which time the counter begins and the respective output driver goes high. The output will continue high until the counter achieves 100 negative edges. It has been assumed that the output inhibit control has not been activated. The inhibit is a control which gates the output "OFF" and can thereby prevent start-up or transient situations.

The register latch has 17 outputs each of which feeds its respective timer (one timer circuit for each output from the register latch). Also, each timer provides access to an output driver.

### Timer Operation

When the timer begins counting and the output goes high, the latch is held reset to prevent retriggering before the count is finished.

During start-up (before reliable count operation), the timers need 128 clock pulses at the timer inputs to guarantee a reset condition before enable pulses are applied.

After an output pulse goes low (becomes inactive), seven clock pulses should be applied at the timer clock input before any timer is retriggered by means of an enable and data "one" combination (repeat of another output pulse at same pin).

The data and the enable pulses together control which combination of timers and driver stages become activated to produce output pulses.





# CD22401

## RECOMMENDED OPERATING CONDITIONS

For maximum reliability, nominal operating conditions should be selected so that operation is always within the following range:

CHARACTERISTIC	LIMITS		UNITS
	V <sub>DD</sub>	V <sub>SS</sub>	
Supply Voltage Range (For T <sub>A</sub> = Full Package Temperature Range)	5	0	V

## STATIC ELECTRICAL CHARACTERISTICS at T<sub>A</sub> = 25°C, V<sub>DD</sub> = 5 V

CHARACTERISTIC	CONDITIONS	LIMITS			UNITS
		Min.	Typ.	Max.	
Input Low Voltage V <sub>IL</sub>		—	—	0.8	V
Input High Voltage V <sub>IH</sub>		2.4	—	—	
Output Voltage Low-Level V <sub>OL</sub>	V <sub>IN</sub> = V <sub>IH</sub> or V <sub>IL</sub>	—	—	—	
	I <sub>OL</sub> = 0 μA *	—	—	0.05	
	I <sub>OL</sub> = 1.6 mA ‡	—	—	0.4	
	I <sub>OL</sub> = 1 mA *	—	—	0.5	
Output Voltage High Level V <sub>OH</sub>	V <sub>IN</sub> = V <sub>IH</sub> or V <sub>IL</sub>	—	—	—	
	I <sub>OH</sub> = 0 μA *	3.5	—	—	
	I <sub>OH</sub> = 5 mA *	3.2	—	—	
	I <sub>OH</sub> = 10 mA *	2.5	—	—	
	I <sub>OH</sub> = 15 mA *	2.2	—	—	
	I <sub>OH</sub> = 0 μA ‡	4.9	—	—	

\* Output Pins 23-39

‡ Output Pins 8, 10

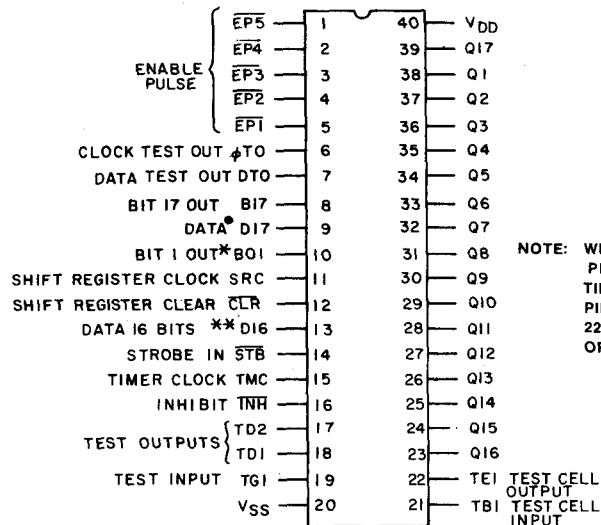

NOTE: WHEN USING CD22401 PIN 19 SHOULD BE TIED TO VSS (OR VDD). PINS 6, 7, 17, 18, 21, AND 22 SHOULD BE LEFT OPEN.

- INPUT TO 1 BIT REGISTER
- \* OUTPUT OF 16 BIT REGISTER
- \*\* INPUT TO 16 BIT REGISTER

92CS-3520IRI

### TERMINAL ASSIGNMENT

DYNAMIC ELECTRICAL CHARACTERISTICS AT  $T_A = 25^\circ\text{C}$ , Input  $t_r, t_f = 20\text{ ns}$ ,  $C_L = 50\text{ pF}$ 

CHARACTERISTIC	FIG.	TEST CONDITIONS		LIMITS			UNITS	
		$V_{DD}(V)$	$C_L$	Min.	Typ.	Max.		
Timer Clock Frequency	$t_{rCL}$	3	5	—	0	0.7	1	MHz
Timer Clock Pulse Width	$t_{WTCL}$	3	5	—	500	—	—	nsec
Timer Clock Rise and Fall Time	$t_{rCK}, t_{fCK}$	5	5	—	—	—	2	$\mu\text{sec}$
Output Inhibit Pulse Width	$t_{WOI}$	5	5	—	500	—	—	nsec
Inhibit Output Turn-Off Delay	$t_{PHI}$	5	5	50	—	—	550	nsec
Output Turn-On Delay after Inhibit is OFF	$t_{PLHI}$	5	5	50	—	—	550	nsec
Enable Pulse (EP) Width	$t_{WHEP}$	3	5	—	500	—	—	nsec
Transfer Strobe Pulse Width *	$t_{WTS}$	3	5	—	350	—	—	nsec
Output L-H Transition Time	$t_{TLH}$	5	4.5	50	—	—	85	nsec
Output H-L Transition Time	$t_{THL}$	5	4.5	50	—	—	150	nsec
Output Turn-On Prop. Delay Time	$t_{PLH}$	5	4.5	50	—	—	1200	nsec
Output Turn-Off Prop. Delay Time	$t_{PHL}$	5	4.5	50	—	—	1200	nsec
High-Level Output Driver Pulse Width	$t_{out}$	3	4.5	50	99	—	100	Timer Clock Pulses
Shift Register Input Clock Frequency	$t_{SRCL}$	2, 4	5	—	—	2	2.5	MHz
Shift Register Clock Pulse Width	$t_{WSRCL}$	2	5	—	200	—	—	nsec
Shift Register Data Set-Up Time	$t_{setup}$	2	5	—	100	—	—	nsec
Shift Register Data Hold Time	$t_{SRHOLD}$	2	5	—	200	—	—	nsec
Shift Register Data Pulse Width	$t_{WSRD}$	2	5	—	300	—	—	nsec
Shift Register Data Output Prop. Delay Time	$t_{PDLH}$	2	5	50	—	—	200	nsec
Shift Register Clear Pulse Width	$t_{SRCLR}$	2	5	—	200	—	—	nsec

\* Data from shift register must be stable at time of transfer.

AC Waveforms

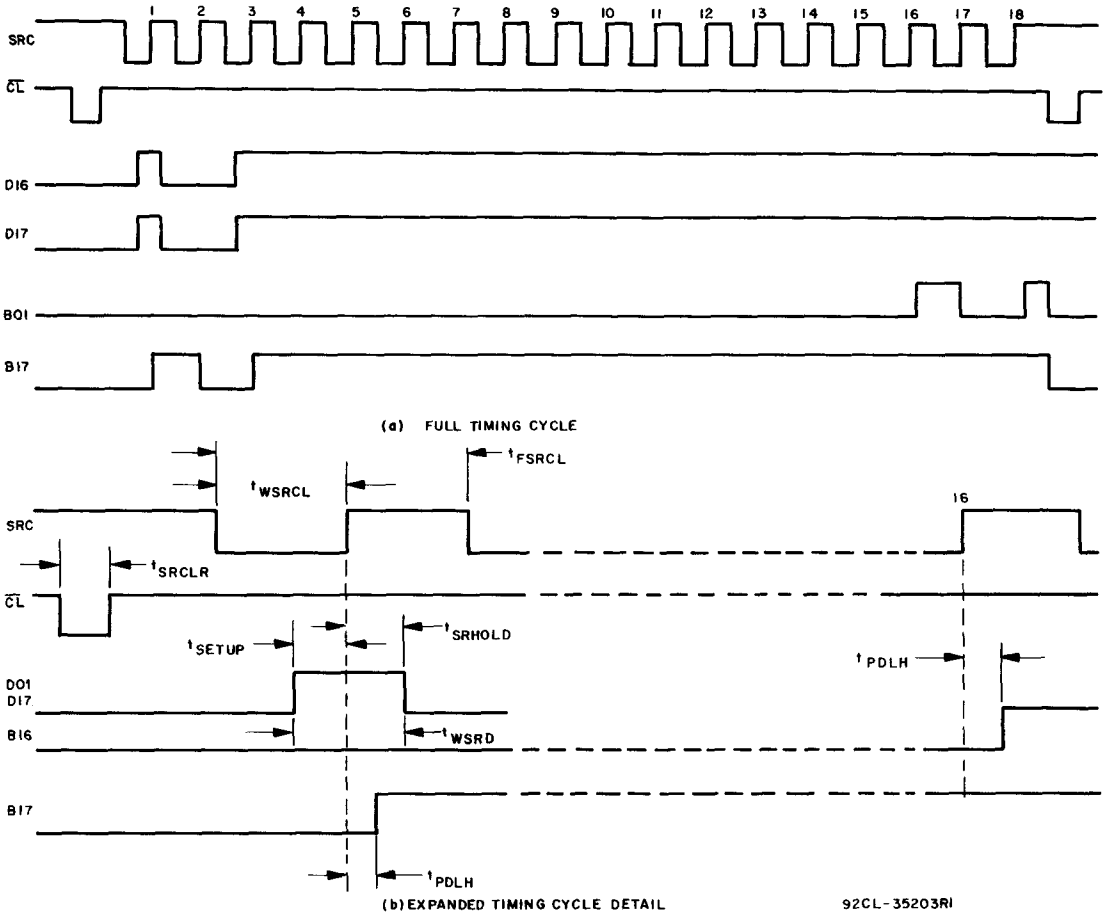

Fig. 2 - Functional timing diagram-shift registers function.

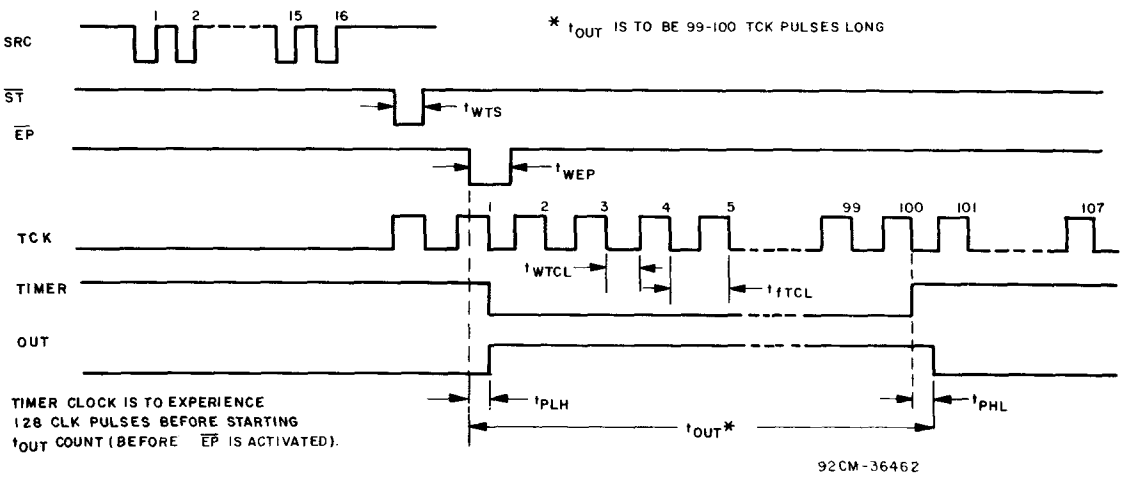
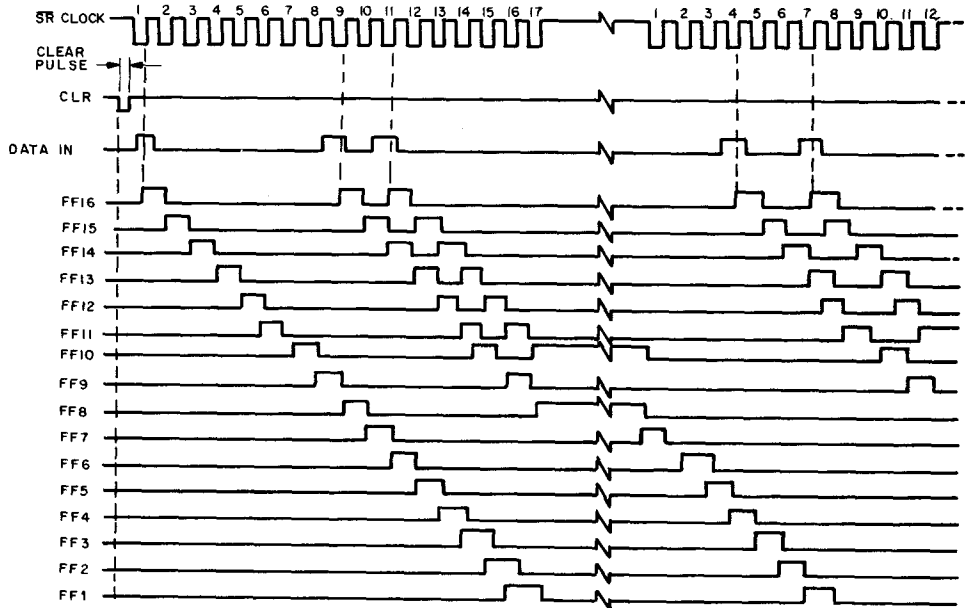
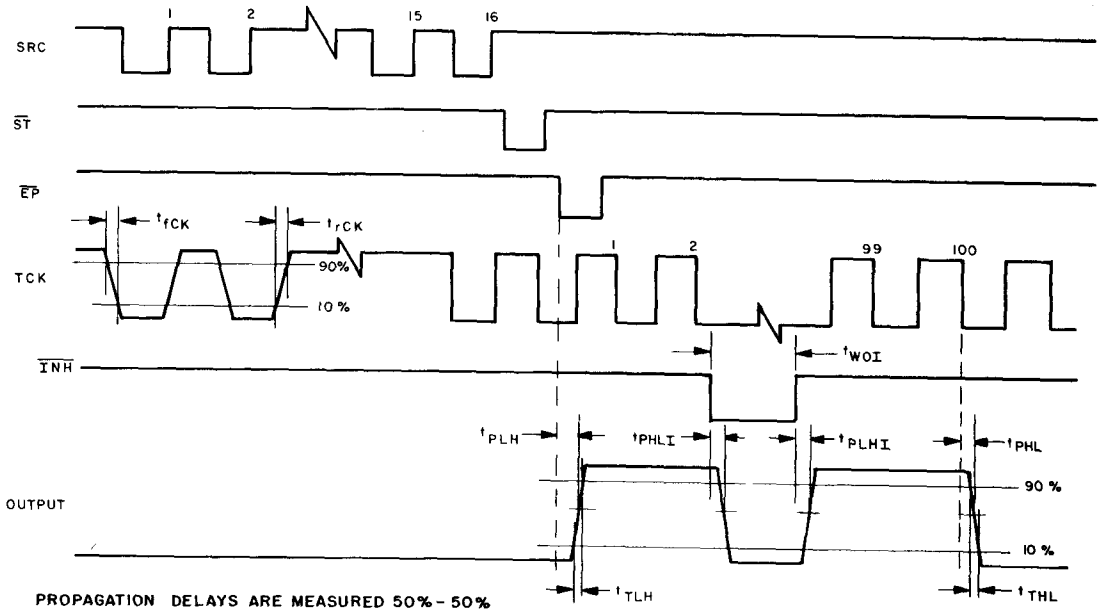

Fig. 3 - Functional timing diagram-shift registers function.



92CM-35204R1

Fig. 4 - Functional timing diagram-shift registers function.



92CM-35205R1

Fig. 5 - Functional timing diagram-shift register function detail.

# CD22413, CD22414 Types

## Preliminary Data

### CMOS Pulse Code Modulation Sampled — Data Filters

The RCA-CD22413 and CD22414 are sampled-data, switched-capacitor filters intended for use in PCM CODEC systems or other telecommunication systems requiring band limiting. Transmit and receive filters in both devices are 5-pole elliptical types, operating at a sample rate of 128 kHz. In addition, the CD22413 contains a 3-pole Chebyshev high-pass filter in the transmit section that provides 50/60 Hz and 15 Hz rejection. Both devices also include two operational amplifiers which may be used as building blocks in a system.

A 50% duty-cycle clock on the convert-clock input (CCI) determines the cutoff frequencies for the filters. The cutoff frequency ( $f_c$ ) is given by the equation:  $f_c = 0.02422 \times \text{Clock Frequency}$ . Normally, the clock frequency is 128 kHz for a cutoff frequency of 3100 Hz. The master sync input (MSI) should be 8 kHz and have its low-to-high transition coincide with each new PAM sample received at Receive-Filter-In (RXI). RXI will accept 19% to 100% duty cycle PAM at 8 kHz.

Timing and synchronization signals (CCI and MSI) may be made either TTL- or CMOS-compatible through use of the Logic-Shift Voltage (VLS) input. Specific input conditions are listed in the table of Logic-Shift-Voltage inputs. The analog ground (VAG) should be held at approximately  $(V_{DD} - V_{SS})/2$ . If VAG is within one volt of  $V_{DD}$  the chip will be powered down. The CD22413 is pin-compatible with the MC14413; the CD22414 is pin-compatible with the MC14414.

The CD22413 and CD22414 are supplied in 16-lead hermetic dual-in-line ceramic packages (D and F suffix), 16-lead dual-in-line plastic packages (E suffix), and chip form (H suffix).

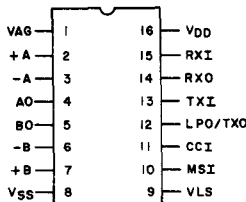

TERMINAL ASSIGNMENTS

#### Features:

- Single supply (10V-16V) or dual supply operation
- Transmit bandpass and receive low pass filters (CD22413)
- Transmit and receive low pass filters (CD22414)
- 30 mW (typ.) operating power

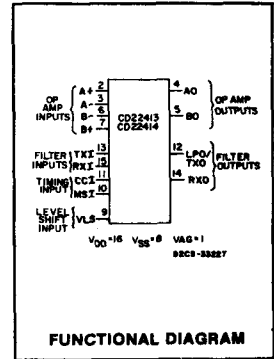

FUNCTIONAL DIAGRAM

#### MAXIMUM RATINGS, Absolute-Maximum Values:

DC SUPPLY-VOLTAGE RANGE, ( $V_{DD}$ )	(Voltages referenced to $V_{SS}$ Terminal)	-0.5 to +18 V
INPUT VOLTAGE RANGE, ALL INPUTS		-0.5 to $V_{DD} + 0.5$ V
DC INPUT CURRENT, ANY ONE INPUT		$\pm 10$ mA
POWER DISSIPATION PER PACKAGE ( $P_D$ )		
For $T_A = -40$ to $+80^\circ\text{C}$ (PACKAGE TYPE E)		500 mW
For $T_A = +60$ to $+85^\circ\text{C}$ (PACKAGE TYPE E)		Derate Linearly at 12 mW/ $^\circ\text{C}$ to 200 mW
For $T_A = -55$ to $+100^\circ\text{C}$ (PACKAGE TYPES D, F)		500 mW
For $T_A = +100$ to $+125^\circ\text{C}$ (PACKAGE TYPES D, F)		Derate Linearly at 12 mW/ $^\circ\text{C}$ to 200 mW
DEVICE DISSIPATION PER OUTPUT TRANSISTOR		
For $T_A = \text{FULL PACKAGE-TEMPERATURE RANGE}$ (All Package Types)		100 mW
OPERATING-TEMPERATURE RANGE ( $T_A$ )		
PACKAGE TYPES D, F, H		-55 to $+125^\circ\text{C}$
PACKAGE TYPE E		-40 to $+85^\circ\text{C}$
STORAGE TEMPERATURE RANGE ( $T_{stg}$ )		-65 to $+150^\circ\text{C}$
LEAD TEMPERATURE (DURING SOLDERING):		
At distance $1/16 \pm 1/32$ inch (1.59 $\pm$ 0.79 mm) from case for 10 s max.		$+265^\circ\text{C}$

#### RECOMMENDED OPERATING CONDITIONS

For maximum reliability, nominal operating conditions should be selected so that operation is always within the following ranges:

CHARACTERISTIC	Terminal Designation	LIMITS			UNITS
		Min.	Typ.	Max.	
DC Supply Voltage (For $T_A = \text{Full Package Temperature Range}$ )	$V_{DD} - V_{SS}$	10	12	16	Vdc
Convert Clock Frequency	CCI	50	128	400	kHz
Master Sync Frequency	MSI	—	8	32	

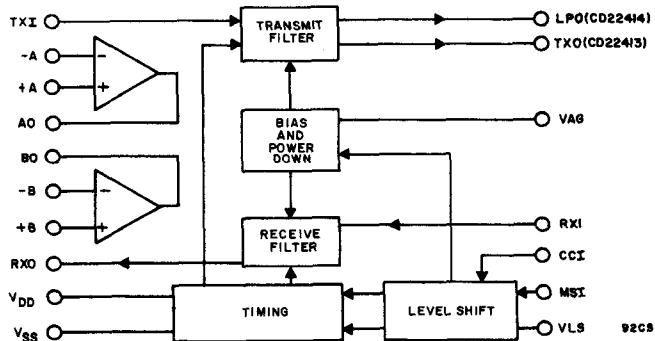

Fig. 1 - Block diagram of CD22413 and CD22414.

## CD22413, CD22414 Types

### DIGITAL ELECTRICAL CHARACTERISTICS ( $V_{SS} = 0\text{ V}$ , $T_A = 25^\circ\text{C}$ )

CHARACTERISTIC	$V_{DD}$ Vdc	LIMITS			UNITS	
		Min.	Typ.	Max.		
Operating Current	I	12	—	2.5	3.5	mA
Power-Down Current, (PDI = $V_{SS}$ )	$I_{PD}$	12	—	10	50	$\mu\text{A}$
Input Capacitance	$C_{IN}$	12	—	5	7.5	pF

### MODE CONTROL LOGIC LEVELS

CHARACTERISTIC	$V_{DD}$ Vdc		LIMITS			UNITS
			Min.	Typ.	Max.	
VLS Power-Down Mode	$V_{IH}$	12	11	—	—	V
		15	14	—	—	
VLS TTL Mode		12	2	—	10	V
		15	2	—	13	
VLS CMOS Mode	$V_{IL}$	12	—	—	0.8	V
		15	—	—	0.8	
VAG Power-Down Mode	$V_{IH}$	12	11	—	—	V
		15	14	—	—	
VAG Analog-Ground Mode	$V_{IL}$	12	—	—	8	V
		15	—	—	11	

### CMOS LOGIC LEVELS ( $V_{LS} = V_{SS}$ )

CHARACTERISTIC	$V_{DD}$ Vdc		LIMITS			UNITS		
			Min.	Typ.	Max.			
Input Current	$I_{IN}$	CCI	12	—	$\pm 0.00001$	$\pm 0.3$	$\mu\text{A}$	
		MSI	—	—	30	—		
		(Internal Pulldown Resistors) "0" Level	—	—	-0.00001	-0.3		
Input Voltage CCI, MSI		"0" Level	$V_{IL}$	12	—	5.25	3.6	V
			15	—	6.75	4		
		"1" Level	$V_{IH}$	12	8.4	6.75	—	
		15	11	8.25	—			

### TTL LOGIC LEVELS ( $V_{LS} = 6\text{ V}$ , $V_{SS} = 0\text{ V}$ )

CHARACTERISTIC	$V_{DD}$ Vdc		LIMITS			UNITS		
			Min.	Typ.	Max.			
Input Current	$I_{IN}$	CCI	12	—	$\pm 0.00001$	$\pm 0.3$	$\mu\text{A}$	
		MSI	—	—	3	—		
		(Internal Pulldown Resistor) "0" Level	—	—	-0.00001	-0.3		
Input Voltage CCI, MSI		"0" Level	$V_{IL}$	12	—	—	VLS + 0.8	V
		"1" Level	$V_{IH}$	12	VLS+2	—	—	

# CD22413, CD22414 Types

**ANALOG ELECTRICAL CHARACTERISTICS** ( $V_{DD} = 12\text{ V}$ ,  $T_A = 25^\circ\text{C}$ )

CHARACTERISTIC		LIMITS			UNITS
		Min.	Typ.	Max.	
Input Current, (RXI, TXI, VAG)	$I_{IN}$	—	$\pm 0.00001$	$\pm 0.03$	$\mu\text{A}$
AC Input Impedance (1 kHz) (RXI, TXI, VAG)	$Z_{IN}$	—	2	—	$\text{M}\Omega$
Input Common Mode Voltage Range (TXI, RXI, +A, -A, +B, -B)	$V_{ICR}$	1.5	—	10.5	V
Input Offset Current (+A to -A, +B to -B)	$I_{IO}$	—	$\pm 10$	—	nA
Input Bias Current (+A, -A, +B, -B)	$I_{IB}$	—	$\pm 0.10$	$\pm 1$	
Input Offset Voltage (+A to -A, +B to -B)	$V_{IO}$	—	$\pm 10$	$\pm 25$	mV
Output Voltage Range (AO, BO, TXO, LPO, RXO) ( $R_L = 20\text{ k}\Omega$ to VAG, $R_B = \infty$ ) ( $R_L = 600\ \Omega$ to VAG, $R_B = 1.6\text{ k}\Omega$ to $V_{DD}$ ) ( $R_L = 900\ \Omega$ to VAG, $R_B = 1.8\text{ k}\Omega$ to $V_{DD}$ )	$V_{OR}$	1.5 4.3 4	— — —	10.5 7.9 8.2	V
Small Signal Output Impedance (1 kHz) (TXO CD22413) (LPO CD22414) (RXO)	$Z_O$	— — —	50 50 50	— — —	$\Omega$
Output Current ( $V_{OH} = 11\text{V}$ ) (TXO, LPO, RXO, AO, BO)	$I_{OH}$	—	-400	—	$\mu\text{A}$
( $V_{OL} = 1\text{V}$ ) (TXO, LPO, RXO, AO, BO)	$I_{OL}$	—	5	—	mA

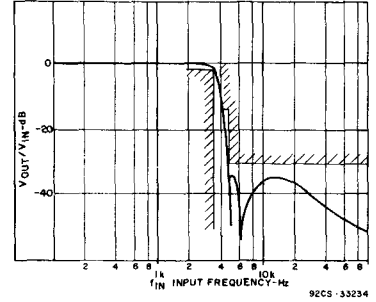

Fig. 3 - Receive filter typical and minimum performance for CD22413 or CD22414 with  $\sin x$  correction included.

**RECEIVE FILTER SPECIFICATIONS** ( $V_{DD} - V_{EE} 12\text{V}$ ,  $CC1 = 128\text{ kHz}$ ,  $MS1 = 8\text{ kHz}$ . Includes  $\sin x$  correction,  $V_{in} = 0\text{ dBm0}$ , full scale =  $+3\text{ dBm0}$ ,  $7\text{ V}_{P-P}$ ,  $T_A = 25^\circ\text{C}$ )

CHARACTERISTIC		LIMITS			UNITS
		Min.	Typ.	Max.	
Gain (1020 Hz)		-0.2	0	+0.2	dB
Passband Ripple (50 Hz to 300 Hz)		—	0.24	0.3	
Out of Band Rejection	See Note 1				
3400 Hz		—	-0.8	-1.5	
4000 to 4600 Hz		-14	-15.5	—	
4600 to 64 kHz		-30	-33	—	
Output Noise (RXI = VAG)	See Note 2	—	10	15	dBm0
Dynamic Range		78	83	—	dB
Differential Group Delay					$\mu\text{s}$
1150 to 2300 kHz Delay		—	12	22	
1000 to 2500 kHz Delay		—	25	35	
800 to 2700 kHz Delay		—	31	41	

Note 1: Referenced to passband minimum. Note 2: Referenced to 9000.

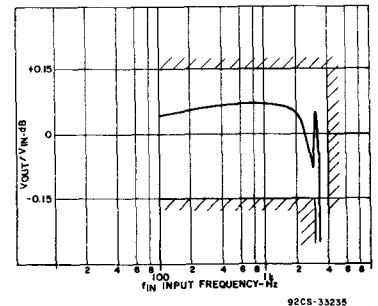

Fig. 4 - Receive filter typical and minimum passband performance for CD22413 or CD22414.



# CD22413, CD22414 Types

**TRANSMIT FILTER SPECIFICATIONS** ( $V_{DD}-V_{EE} = 12\text{ V}$ ,  $CCI = 128\text{ kHz}$ ,  $MSI = 8\text{ kHz}$ ,  $V_{in} = 0\text{ dBm0}$ , full scale = +3 dBm0,  $7\text{ V}_{p-p}$ ,  $T_A = 25^\circ$ )

CHARACTERISTIC	LIMITS			UNITS
	Min.	Typ.	Max.	
Gain (1020 Hz)	-0.15	—	+0.15	dB
Passband Ripple (300 Hz to 3000 Hz)	—	0.22	0.3	
Rejection	See Note 1			
60 Hz	-20	-24	—	
180 Hz	—	-0.6	-1	
3400 Hz	—	-0.8	-1.5	
4000 to 4600 Hz	-14	-15.5	—	dB
4600 to 64 kHz	-32	-33	—	
Output Noise (300 to 3400 Hz)	—	—	—	dBrnc0
	—	8	12	dB
Dynamic Range (7 Vpp Max)	81	87	—	
Differential Group Delay				$\mu\text{s}$
1150 to 2300 kHz Delay	—	12	22	
1000 to 2500 kHz Delay	—	25	35	
800 to 2700 kHz Delay	—	31	41	

Note 1: Referenced to passband minimum.

## SWITCHING CHARACTERISTICS ( $V_{DD} - V_{SS} = 10\text{ V}$ , $T_A = 25^\circ\text{C}$ )

CHARACTERISTIC		LIMITS			UNITS
		Min.	Typ.	Max.	
Input Rise and Fall Time, $t_r$ , $t_f$	CCI, MSI	—	—	4	$\mu\text{s}$
Pulse Width, $t_{WH}$	CCI, MXI	100	50	—	ns
Clock Pulse Frequency, $f_{cl}$	CCI	50	—	500	kHz
Set Up Time, $t_{SU}$					
MSI Rising Edge to CCI Rising Edge (CCI = 128 kHz)*		-3	—	+3	$\mu\text{s}$

\*Specifications assume use of 50% duty cycle for clocks.

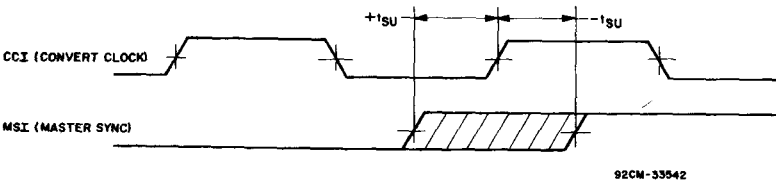

Fig. 2 - Switching characteristics wave forms.

## LOGIC SHIFT VOLTAGE INPUTS

VLS PIN	LOGIC INPUT (CCI AND MSI)
$V_{SS} < V_{LS} < V_{SS} + 0.8\text{ V}$	CMOS
$V_{DD} - 1\text{ V} < V_{LS} < V_{DD}$	POWER DOWN
$V_{SS} + 2\text{ V} < V_{LS} < V_{DD} - 2\text{ V}$	TTL ( $V_{LS} + 0.8\text{ V} < \text{INPUT} < V_{LS} + 2\text{ V}$ )

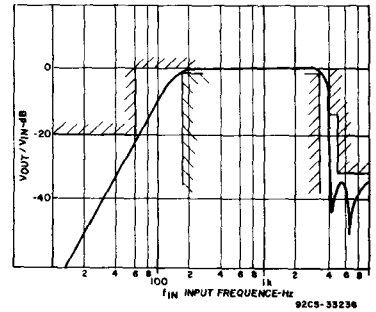

Fig. 5 - Transmit filter typical and minimum performance for CD22413 or CD22414 using Figs. 11 and 12.

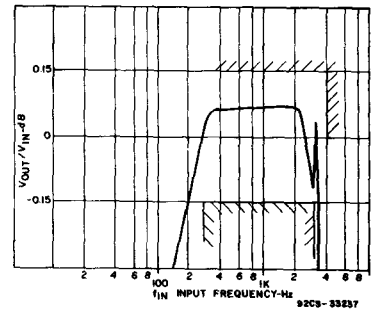

Fig. 6 - Transmit filter typical and minimum passband performance for CD22413 or CD22414 using Figs. 11 or 12.

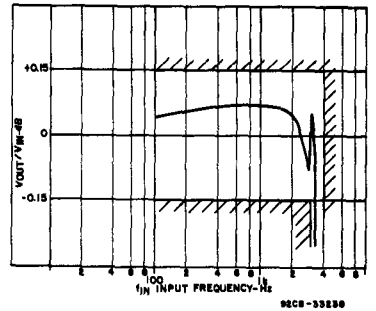

Fig. 7 - Transmit filter typical and minimum passband performance for CD22414.

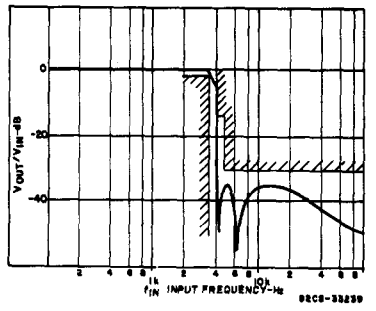

Fig. 8 - Transmit filter typical and minimum performance for CD22414.



# CD22413, CD22414 Types

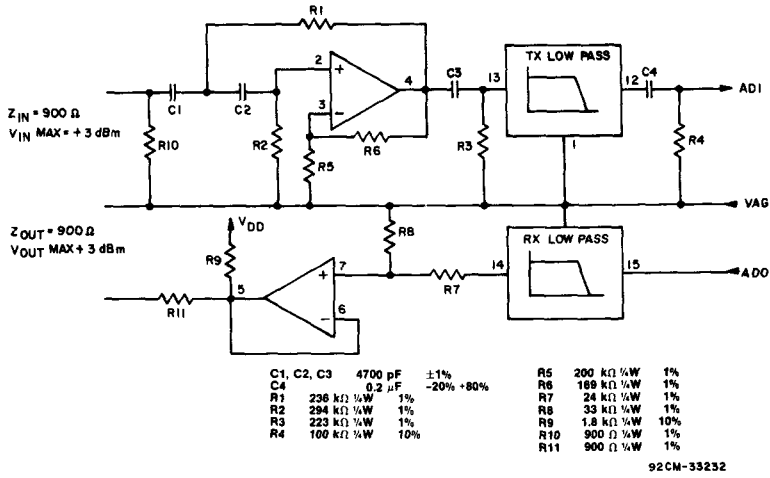

Fig. 12 - Filter schematic for CD22414 with 60-Hz rejection and 900-Ω termination.

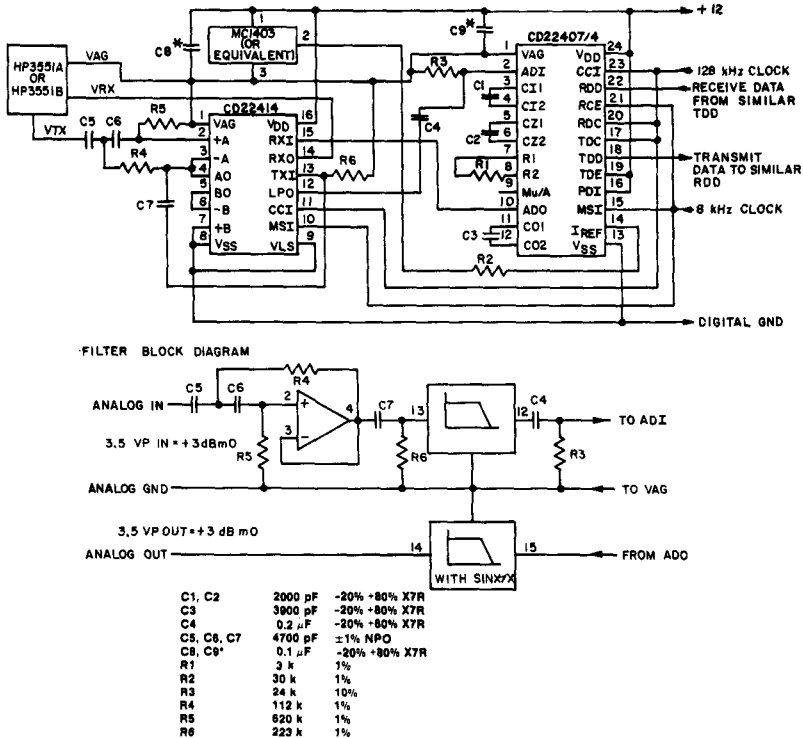

Fig. 13 - Analog transmission test circuit for CD22414 PCM filter and CD22407/CD22404 PCM CODEC.

# CD22413, CD22414 Types

## TYPICAL END TO END PERFORMANCE OF RCA CODEC & FILTER

All measurements made using HP3779B PCM Test Set. See Fig. 13.

SPECIFICATION	Performance of CD22407/4 CODEC & CD22414 Filter	Bell System D3 Voice Freq. Requirements PUB 43801	CCITT G7.12 Voice Freq. Requirements
Channel Saturation	+3 dBm0	+3 dBm0	+3 dBm0
Gain Tracking with 1 kHz tone			
+3 to -40 dBm0	±0.3 dB	≤±0.5 dB	≤±0.5 dB
-40 to -50 dBm0	±0.6 dB	≤±1 dB	≤±1 dB
-55 dBm0	±2 dB	≤±3 dB	≤±3 dB
Quantizing Distortion @ 1 kHz			
+3 to -30 dBm0	37 dB	≥33 dB	>33 dB
-35 dBm0	34 dB	≥30 dB	≥30 dB
-40 dBm0	31 dB	≥27 dB	≥27 dB
-45 dBm0	26 dB	≥22 dB	≥22 dB
Idle Channel Noise with VTX = VAG	17 dBrcn0	≤23 dBrcn0	≤-64 dBm0P
Quiet Code Noise (all 1's at decoder (RDD) Input)	15 dBrcn0	≤15 dBrcn0	≤-75 dBm0P
Selective Response @ multiples of 8 kHz	-60 dBm0	See Frequency Response	≤-50 dBm0
Frequency Response @ 0 dBm0 input			
50 Hz gain	-26 dB	—	≤-24 dB
60 Hz gain	-22 dB	≤-20 dB	—
200 to 300 Hz ripple	45 dB	≤0.6 dB	≤1 dB
3400 Hz gain	-1.6 dB	≥-3 dB	≥-1.8 dB
4000 Hz gain	-35 dB	≤-28 dB	≤-28 dB
≥4600 Hz gain	<-62 dB	≤-60 dB	≤-60 dB
Single Frequency Spurious Response			
In band with input 1 kHz @ 0 dBm	≤-44 dB	≤-40 dB	≤-40 dB
Out of band with input 0 to 12 kHz @ 0 dBm	≤-32.5 dB	≤-28 dB	≤-25 dB
Differential Delay Distortion			
1150 to 2300	58 μs	≤60 μs	—
1000 to 2500	72 μs	≤100 μs	—
900 to 2700	91 μs	≥200 μs	—

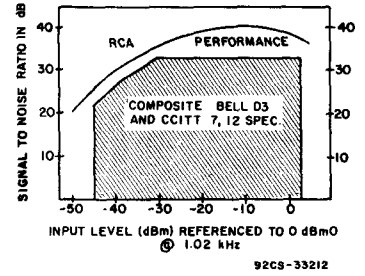

Fig. 14 - Signal-to-noise performance for CD22407 and CD22414. (See Fig. 13.)

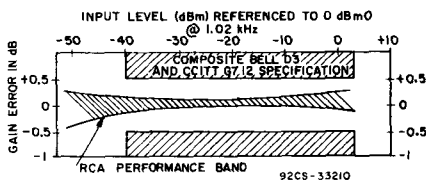

Fig. 15 - Gain tracking error for CD22407 and CD22414. (See Fig. 13.)

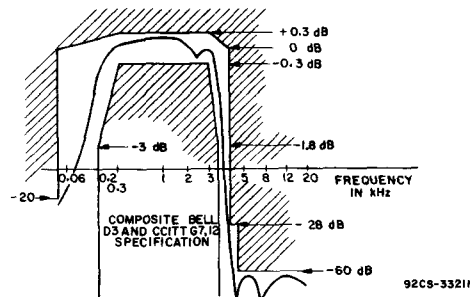

Fig. 16 - Frequency response of CD22407 and CD22414 CODEC and filter. (See Fig. 13.)

# CMOS Dual-Tone Multifrequency Tone Generator

For Use in Dual-Tone Telephone  
Dialing Systems

**Features**

- Mute drivers on chip
- Device power can either be regulated dc or telephone loop current
- Use of an inexpensive 3.579545-MHz TV crystal provides high accuracy and stability for all frequencies

**General Description**

The RCA-CD22859 is a CMOS dual-tone multifrequency (DTMF) tone generator for use in dual-tone telephone dialing systems. The device can easily be interfaced to a standard pushbutton telephone keyboard, to provide enabling operation directly with the telephone lines.

The CD22859 generates standard DTMF sinusoidal dialing tones from an on-chip reference crystal oscillator. The reference oscillator uses an inexpensive 3.579545-MHz color TV crystal to create highly stable and accurate tones. The sinusoidal tones are digitally synthesized by a stair-step approximation.

One of four low-frequency band row tones and one of four high-frequency band column tones are selected by driving one of the four row inputs and one of the four column inputs low. Simultaneous selection of more than one row input and/or more than one column input will inhibit tone generation, or generate a single-tone sinusoid. These operating modes are described in the functional truth table.

Control logic is included to allow easy interface to standard K500-type telephones. Two CMOS outputs Tx, Rx, capable of driving external p-n-p receiver and transmitter muting transistors are provided. A low input to the CD pin, inhibits tone generation, turns off the reference oscillator, and causes Tx and Rx outputs to logic '0'. During tone generation mode,  $\overline{CD} = 1$  and Tx, Rx = logic 1.

All row, column, and  $\overline{CD}$  inputs are provided with pull-up resistors to allow the use of SPST switch matrices.

The CD22859 types are supplied in a 16-lead hermetic dual-in-line side-brazed ceramic package (D suffix), and a 16-lead dual-in-line plastic package (E suffix), and in chip form (H suffix).

**MAXIMUM RATINGS, Absolute-Maximum Values:**

DC SUPPLY VOLTAGE RANGE ( $V_{DD} - V_{SS}$ )	- 0.5 to + 12 V
INPUT VOLTAGE RANGE	- 0.5 to $V_{DD} + 0.5$ V
POWER DISSIPATION, $P_D$ :	
At $T_A = -40^\circ\text{C}$ to $+60^\circ\text{C}$	500 mW
At $T_A = +60^\circ\text{C}$ to $+85^\circ\text{C}$	Derate Linearly at 12 mW/ $^\circ\text{C}$ to 200 mW
POWER DISSIPATION PER OUTPUT	100 mW
OPERATING TEMPERATURE RANGE	- 40 $^\circ\text{C}$ to $+85^\circ\text{C}$
LEAD TEMPERATURE DURING SOLDERING:	
At distance 1/16 $\pm$ 1/32 in. (1.59 $\pm$ 0.79 mm)	
from case for 10 s max.	+ 265 $^\circ\text{C}$

DTMF Generator Functional Truth Table

Keyboard Mode	Inputs		$\overline{CD}$	Tone	Outputs		
	Number of Column Inputs Activated "Low"	Number of Row Inputs Activated Low			OSC Running	RX	TX
X	X	X	"0"	None	No	"0"	"0"
No key depressed	0	0	"1"	None	No	"0"	"0"
Normal Dialing One Key Depressed (See Note 1)	0	1	"1"	Dual Tone	Yes	"1"	"1"
	1,2,3, or 4	0	"1"	None	No	"0"	"0"
Two or More Keys In Same Row (See Note 2)	1	1	"1"	Dual Tone	Yes	"1"	"1"
	2,3, or 4	1	"1"	Single Row Tone $R_a$	Yes	"1"	"1"
Two or More Keys In Same Column	1	2,3, or 4	"1"	Single Column Tone $C_b$	Yes	"1"	"1"
Two or More Keys In Different Rows & Columns	2,3 or 4	1	"1"	None	Yes	"1"	"1"
	1	1	1	None	Yes	"1"	"1"

**Where:**

X = Do Not Care

$R_a, C_b$  refers to Tone Output frequencies corresponding to Row 1, Row 2, Row 3, Row 4, Column 1, Column 2, Column 3, Column 4

a = 1,2,3,4 b = 1,2,3,4 a = b, or a  $\neq$  b

1. Corresponds to normal dual-tone operation.
2. Corresponds to single-tone generation mode.

# CD22859 Types

## STATIC ELECTRICAL CHARACTERISTICS at T<sub>A</sub> = -25 °C to +60 °C

CHARACTERISTIC	V <sub>DD</sub> (V)	V <sub>O</sub> (V)	LIMITS		UNITS
			Min.	Max.	
<i>Tone Outputs (R<sub>L</sub> = 82)</i>					
V <sub>O</sub> ; Dual-Tone Output	3.7-9.3		350	700	mV rms
V <sub>O</sub> (CL); Single-Tone Output, Column*	3.7-9.3		300	—	mV rms
V <sub>O</sub> (RL); Single-Tone Output, Row**	3.7-9.3		260	—	mV rms
Distortion (Note 1)	3.9-9.3		—	10	%
Rise and Fall Time (Dual-Tone Out) (Note 2)	3.9-9.3		—	5	ms
Pre-Emphasis (Note 3)	3.9-9.3		1	3	dB
Output Frequency (Note 4)	3.9-9.3		(Nom. - 1%)	(Nom. + 1%)	Hz
<i>Mute Output Current</i>					
<i>Transmitter</i>					
I <sub>OH</sub> (Source)	1.7	1.2	-0.5	—	mA
	10	9.5	-3.4	—	
I <sub>OL</sub> (Sink)	10	2.5	—	10	μA
<i>Receiver</i>					
I <sub>OH</sub> (Source)	1.7	1.2	-0.5	—	mA
	10	9.5	-3.4	—	
I <sub>OL</sub> (Sink)	10	2.5	—	10	μA

\*Two or more row inputs low, and one column input low.

\*\*Two or more column inputs low, and one row input low.

### Notes:

- Distortion is defined as: The ratio of all extraneous frequency components generated in the voiceband 0.5 kHz to 3 kHz, to the power of the dual-tone signal, measure across R<sub>L</sub>.

$$= \frac{(V_1^2 + V_2^2 + \dots + V_n^2)}{V_L^2 + V_H^2}$$

where V<sub>1</sub>, V<sub>2</sub>, . . . V<sub>n</sub> are extraneous frequency components in the voiceband 0.5 kHz to 3 kHz, V<sub>L</sub> is the low-

band frequency tone, and V<sub>H</sub> is the high-band frequency tone.

- Tone rise time is defined as the time for each of the 2 DTMF frequencies to attain 90% of full amplitude, measured from the time when a row and column signal are driven low.
- Pre-emphasis is the ratio of the high-group level to the low-group level.
- Refer to Fig. 1 for standard DTMF frequencies.

## DYNAMIC ELECTRICAL CHARACTERISTICS at T<sub>A</sub> = -25 °C to +60 °C

All voltages referenced to V<sub>SS</sub> = 0 V.

CHARACTERISTIC	V <sub>DD</sub>	LIMITS		UNITS
		Min.	Max.	
<i>DC Supply Voltage</i>				
Tone Generation Mode with Valid Input*		2.5	10	V
Non-Tone Generation**		1.7	10	
<i>Operating Current</i>				
Tone Generation Mode (Outputs Unloaded)	3.7 V		1.7	mA
	9.3 V		13	
No Keydown Mode	3.7 V		100	μA
	9.3 V		200	
Input Pull-Up Current	3-10 V		400	μA
Input Low Voltage (V <sub>IL</sub> ) Max.	3-10 V		0.2 V <sub>DD</sub>	V
Input High Voltage (V <sub>IH</sub> ) Min.	3-10 V	0.8 V <sub>DD</sub>		V

\*All logic and counters functional.

\*\*Mute switches remain open.

# CD22859 Types

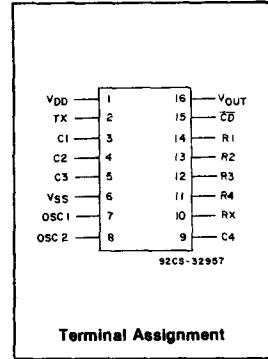
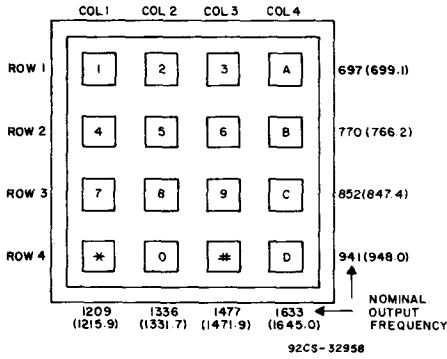

Fig. 1 - Bell and nominal output frequencies (in parenthesis) for 3.579545-MHz crystal.

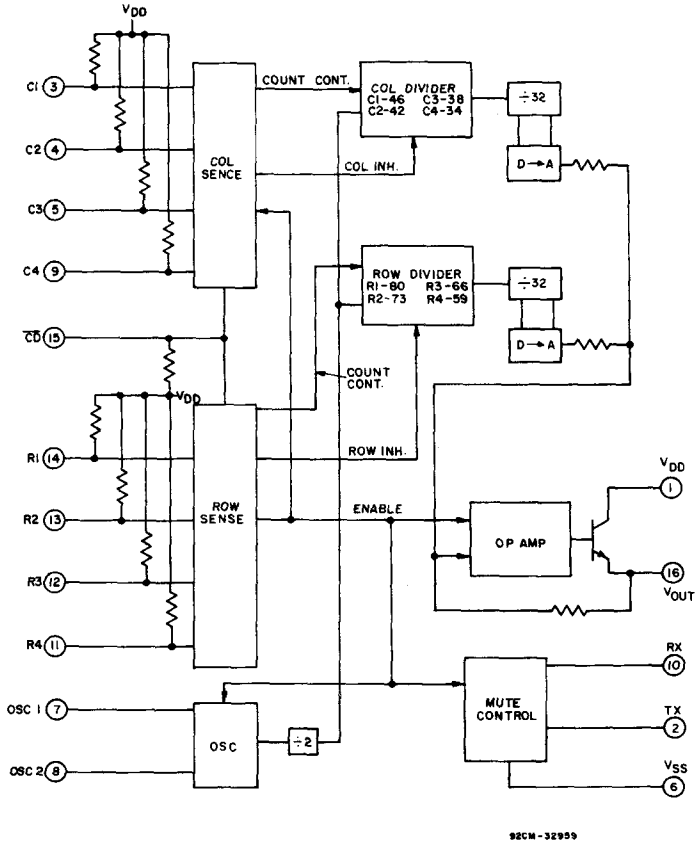

Fig. 2 - Touch-tone generator.

# CD22859 Types

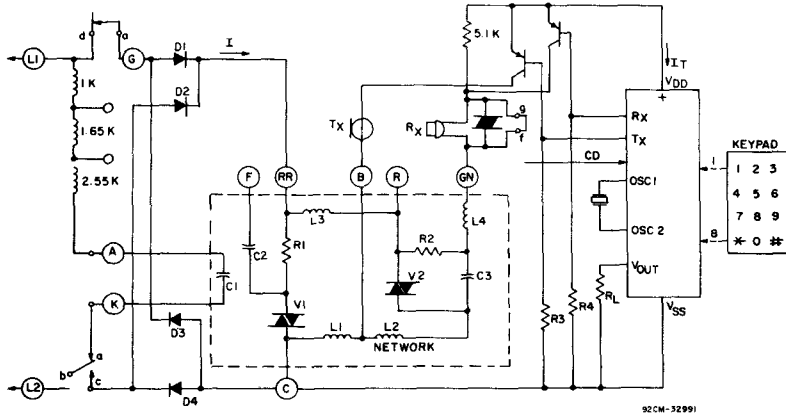
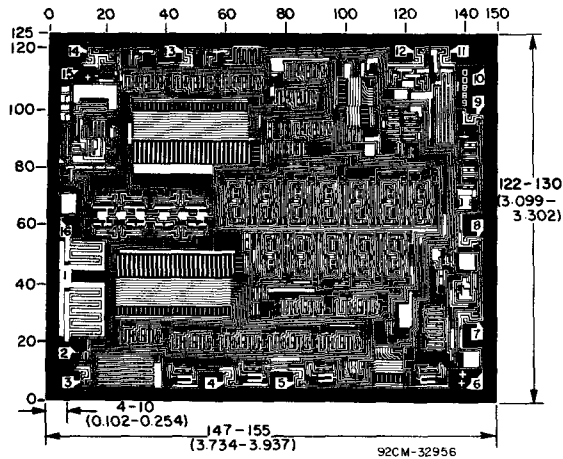

Fig. 3 - Interface with standard K500 telephone network.



Dimensions in parentheses are in millimeters and are derived from the basic inch dimensions as indicated. Grid graduations are in mils (10<sup>-3</sup> inch).

The photographs and dimensions of each CMOS chip represent a chip when it is part of the wafer. When the wafer is separated into individual chips, the angle of cleavage may vary with respect to the chip face for different chips. The actual dimensions of the isolated chip, therefore, may differ slightly from the nominal dimensions shown. The user should consider a tolerance of -3 mils to +16 mils applicable to the nominal dimensions shown.

Dimensions and pad layout for CD22859H chip.



# CMOS High-Speed 8-Bit Bidirectional CMOS/TTL Interface Level Converter

The RCA-CD40115 is a high-speed 8-bit integrated circuit designed to interface CMOS logic levels with TTL logic levels on the data bus of microprocessor-based systems. CMOS/TTL interface is provided by eight parallel bidirectional buffer/level converters. Buffer INPUT/OUTPUT terminals are either inputs or outputs depending on the desired direction of data flow. A low on both the ENABLE and DISABLE control inputs selects the direction of data flow from CMOS Inputs to TTL Outputs. A high on both control inputs selects the direction of data flow from TTL Inputs to CMOS Outputs. A low on the ENABLE and a high on the DISABLE inhibits data flow in either direction and places the CMOS Outputs in a high-impedance (3-state) mode.

The TTL Input/Output terminals and the ENABLE and DISABLE control inputs are TTL-compatible without the use of external pull-up resistors. The TTL input logic 0 to logic 1 transition occurs at a level of approximately 1.5 volts. The ENABLE and DISABLE inputs may be driven to the V<sub>DD</sub> rail; therefore, either TTL or CMOS logic drivers, capable of sinking one TTL load, may be used to determine the direction of data flow. The large CMOS and TTL output

**Features:**

- Eight inverting channels with 5V-to-12V or 12V-to-5V level conversion
- Three operating modes:  
CMOS-to-TTL level conversion  
TTL-to-CMOS level conversion  
Interface off; high-impedance CMOS input/output
- Low propagation delay time:  
CMOS-to-TTL conversion – 10 ns typ.  
TTL-to-CMOS conversion – 30 ns typ.
- High TTL sink current – 30 mA typ.
- No external TTL input pull-up resistors required
- High speed drive of large data bus capacitances
- Input/output and power supply terminals located for ease of PC board layout

buffers in this device have high output sink and source current capability and can drive the data bus capacitance with a transition time of approximately 0.1 ns/pF. This fast output transition time, together with the small propagation delay time of the device, allow high-speed operation.

The CD40115 is supplied in a 22-lead hermetic dual-in-line ceramic package.

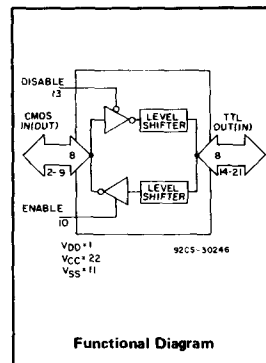

**Applications:**

- Interface CMOS microprocessor with TTL memories and peripheral devices
- Interface between and within logic systems which combine CMOS and TTL devices

**MAXIMUM RATINGS, Absolute-Maximum Values:**

DC SUPPLY-VOLTAGE RANGE (Voltages referenced to VSS Terminal)	
V <sub>DD</sub>	-0.5 to +12.6 V
V <sub>CC</sub>	-0.5 to +6 V
INPUT VOLTAGE RANGE:	
Data Inputs, CMOS to TTL	-0.5 to V <sub>DD</sub> +0.5 V
Data Inputs, TTL to CMOS	-0.5 to V <sub>CC</sub> +0.5 V
Enable, Disable Inputs	-0.5 to V <sub>DD</sub> +0.5 V
POWER DISSIPATION PER PACKAGE (P <sub>D</sub> ):	
For T <sub>A</sub> = -55°C to +100°C	500 mW
For T <sub>A</sub> = +100 to +125°C	Derate Linearly at 12 mW/°C to 200 mW
DEVICE DISSIPATION PER OUTPUT TRANSISTOR	
For T <sub>A</sub> = Full Package-Temperature Range	100 mW
OPERATING TEMPERATURE RANGE (T <sub>A</sub> )	
	-55 to +125°C
STORAGE TEMPERATURE RANGE (T <sub>stg</sub> )	
	-65 to +150°C
LEAD TEMPERATURE (DURING SOLDERING):	
At distance of 1/16 ± 1/32 inch (1.59 ± 0.79 mm) from case for 10 s max.	+265°C

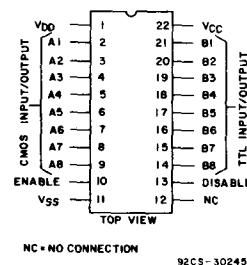

**TERMINAL ASSIGNMENT**

**TRUTH TABLE**

ENABLE	DISABLE	FUNCTION
0	0	Convert CMOS Level to TTL Level
1	1	Convert TTL Level to CMOS Level
0	1	High Impedance (Z)
1	0	Invalid*

0 = Low Level      1 = High Level  
Z = High Impedance on CMOS Output side; TTL side are inputs.  
INVALID = Both CMOS and TTL sides are ON as outputs.

See Operating and Handling Considerations – Bypassing and Unused Inputs.

\* Excessively high currents from V<sub>DD</sub> to V<sub>SS</sub> could flow in this mode during power turn-on or turn-off if other IC's drive into the bus lines (on either the TTL or CMOS side). This high current condition could occur during a transient or steady-state invalid mode.

# CD40115

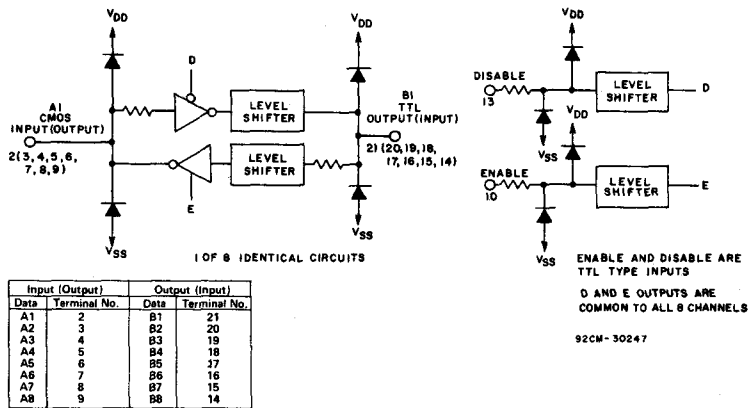

Fig. 1 - Functional block diagram.

## STATIC ELECTRICAL CHARACTERISTICS At $T_A = 25^\circ\text{C}$ , $V_{DD} = 12\text{ V}$ , $V_{CC} = 5\text{ V}$

CHARACTERISTIC	TEST CONDITIONS	TYPICAL VALUES	UNITS
<b>Data Flow - CMOS Inputs to TTL Outputs</b>			
Quiescent Device Current, From $V_{DD}$ Supply, From $V_{CC}$ Supply,	$I_{DD}$	4	mA
	$I_{CC}$	5	$\mu\text{A}$
Input Current,	$I_{IN}$ $V_{IN}=0, 12\text{ V}$ ; Any CMOS input	$\pm 50$	$\mu\text{A}$
Output Current,	$I_{OH}$ $V_{OH}=3\text{ V}$ , $V_{IL}=2\text{ V}$	15	mA
	$I_{OL}$ $V_{OL}=0.4\text{ V}$ , $V_{IH}=10\text{ V}$	30	
<b>Data Flow - TTL Inputs to CMOS Outputs</b>			
Quiescent Device Current, From $V_{DD}$ Supply, From $V_{CC}$ Supply,	$I_{DD}$	4	mA
	$I_{CC}$	5	$\mu\text{A}$
Input Current,	$I_{IL}$ $V_{IL}=0$ to $0.7\text{ V}$ ; Any TTL input	-250	$\mu\text{A}$
	$I_{IH}$ $V_{IH}=2.3\text{ V}$ ; Any TTL input	-50	
Output Current,	$I_{OH}$ $V_{OH}=11.5\text{ V}$ , $V_{IL}=0.7\text{ V}$	20	mA
	$I_{OL}$ $V_{OL}=0.5\text{ V}$ , $V_{IH}=2.3\text{ V}$	20	
CMOS 3-State Output Leakage Current,	$I_{OUT}$ $V_O=0.12\text{ V}$ , $V_{IN}=0.5\text{ V}$	$\pm 50$	$\mu\text{A}$
<b>Enable and Disable Inputs</b>			
Input Current,	$I_{IL}$ $V_{IL}=0$ to $0.7\text{ V}$	-250	$\mu\text{A}$
	$I_{IH}$ $V_{IH}=2.3\text{ V}$ (TTL)	-50	
	$I_{IH}$ $V_{IH}=12\text{ V}$ (CMOS)	50	

## DYNAMIC ELECTRICAL CHARACTERISTICS At $T_A = 25^\circ\text{C}$ , $V_{DD} = 12\text{ V}$ , $V_{CC} = 5\text{ V}$

CHARACTERISTIC	TEST CONDITIONS		TYPICAL VALUES		UNITS
	INPUT	OUTPUT	$C_L = 50\text{ pF}$	$C_L = 200\text{ pF}$	
Propagation Delay Times, Data-In to Data-Out, $t_{PHL}$ , $t_{PLH}$	CMOS	TTL	10	15	ns
	TTL	CMOS	30	40	
Enable or Disable to Data-Out, $t_{PHZ}$ , $t_{PZH}$ , $t_{PLZ}$ , $t_{PZL}$			35		ns
Transition Time, $t_{THL}$ , $t_{TLH}$	CMOS	TTL	10	15	ns
	TTL	CMOS	10	15	

# CMOS High-Speed 8-Bit Bidirectional CMOS/TTL Interface Level Converter

**Features:**

- Eight inverting channels with conversion from  $V_{DD}$  to  $V_{CC}$  or  $V_{CC}$  to  $V_{DD}$  ( $4V \leq V_{DD} \leq 12V$  and  $4V \leq V_{CC} \leq V_{DD}$ )
- Three operating modes:  
 CMOS-to-TTL level conversion  
 TTL-to-CMOS level conversion  
 Interface off; high-impedance on both sides

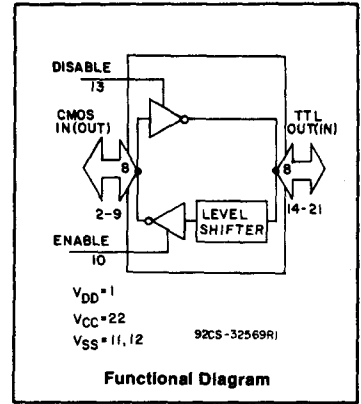

The RCA-CD40116 is a high-speed 8-bit integrated circuit designed to interface CMOS logic levels with TTL logic levels on the data bus of microprocessor-based systems. CMOS/TTL interface is provided by eight parallel bidirectional buffer/level converters. Buffer INPUT/OUTPUT terminals are either inputs or outputs depending on the desired direction of data flow.

A low level on the DISABLE input with the ENABLE input either high or low, permits conversion of CMOS inputs to TTL outputs. A high level on both the DISABLE and ENABLE inputs permits data flow from TTL inputs to CMOS outputs. A low level on the ENABLE input and a high level on the DISABLE input sets both inputs/outputs to the high-impedance state.

The TTL Input/Output terminals and the ENABLE and DISABLE control inputs are TTL-compatible without the use of external pull-up resistors. The TTL input logic 0 to logic 1 transition occurs at a level of approximately 1.5 volts. The ENABLE and DISABLE inputs may be driven to the  $V_{DD}$  rail; therefore, either TTL or CMOS logic drivers, capable of sinking one TTL load, may be used to determine the direction of data flow. The large CMOS and TTL output buffers in this device have high output sink and source current capability and can drive the data bus capacitance with a transition time of approximately 0.25 ns/pF. This fast output transition time, together with the small propagation delay time of the device, allow high-speed operation.

Pin 12 is an additional  $V_{SS}$  Pin which is connected directly to the TTL-to-CMOS converters to avoid oscillation in these amplifiers. Pin 12 is connected to Pin 11 through a poly resistor which isolated Pin 12 from  $V_{SS}$  switching noise (ground noise).

The CD40116 is supplied in a 22-lead hermetic dual-in-line ceramic package (D suffix), 22-lead plastic package (E suffix), and in chip form (H suffix).

- Low propagation delay time:  
 CMOS-to-TTL conversion - 25 ns typ.  
 TTL-to-CMOS conversion - 30 ns typ.  
 ( $V_{DD} = 12V, V_{CC} = 5V$ )
- High TTL sink current - 11 mA typ.
- No external TTL input pull-up resistors required
- High speed drive of large data bus capacitances
- Input/output and power supply terminals located for ease of PC board layout

**Applications:**

- Interface CMOS microprocessor with TTL memories and peripheral devices
- Interface between and within logic systems which combine CMOS and TTL devices

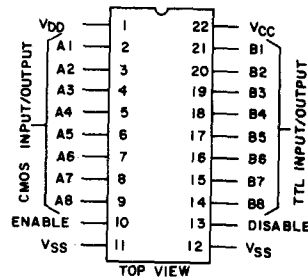

92CS-30245

**TERMINAL ASSIGNMENT**

# CD40116 Types

## MAXIMUM RATINGS, Absolute-Maximum Values:

DC SUPPLY-VOLTAGE RANGE (Voltage reference to $V_{SS}$ Terminal)	
$V_{DD}$ .....	-0.5 to +12.8 V*
$V_{CC}$ .....	-0.5 to $V_{DD}$
INPUT VOLTAGE RANGE:	
Data Inputs, CMOS to TTL .....	-0.5 to $V_{DD}$ + 0.5 V
Data Inputs, TTL to CMOS .....	-0.5 to $V_{CC}$ + 0.5 V
Enable, Disable Inputs .....	-0.5 to $V_{DD}$ + 0.5 V
POWER DISSIPATION PER PACKAGE ( $P_D$ ):	
For $T_A = -40^\circ\text{C}$ to $+60^\circ\text{C}$ (E) .....	500 mW
For $T_A = +60^\circ\text{C}$ to $+85^\circ\text{C}$ (E) .....	Derate linearly at 12 mW/ $^\circ\text{C}$ to 200 mW
For $T_A = -55^\circ\text{C}$ to $+100^\circ\text{C}$ (D) .....	500 mW
For $T_A = +100$ to $+125^\circ\text{C}$ (D) .....	Derate linearly at 12 mW/ $^\circ\text{C}$ to 200 mW
DEVICE DISSIPATION PER OUTPUT TRANSISTOR	
For $T_A =$ Full Package-Temperature Range .....	100 mW
OPERATING TEMPERATURE RANGE ( $T_A$ )	
Package Type D .....	-55 to +125 $^\circ\text{C}$
Package Type E .....	-40 to +85 $^\circ\text{C}$
STORAGE TEMPERATURE RANGE ( $T_{stg}$ ) .....	
-65 to +150 $^\circ\text{C}$	
LEAD TEMPERATURE (DURING SOLDERING):	
At distance of $1/16 \pm 1/32$ inch ( $1.59 \pm 0.79$ mm)	
from case for 10 s max .....	+265 $^\circ\text{C}$

\*At 125 $^\circ\text{C}$   $V_{DD}$  should not exceed +12 V.

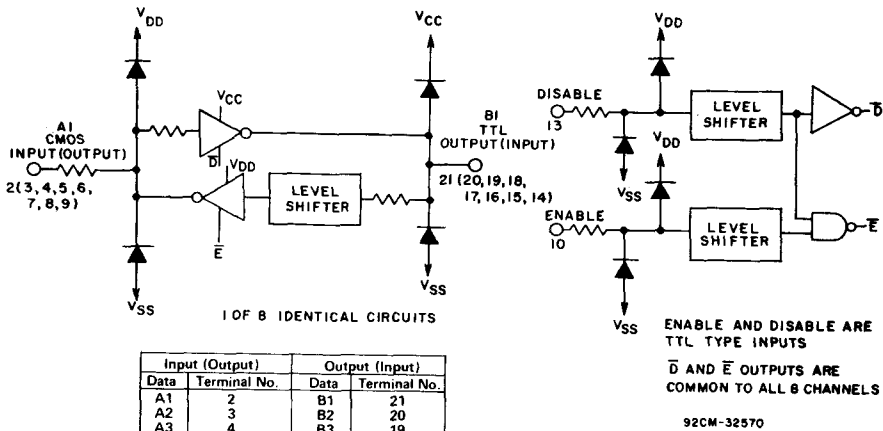

Fig. 1 - Functional block diagram.

### TRUTH TABLE

ENABLE	DISABLE	FUNCTION
X	0	Convert CMOS Level to TTL Level
1	1	Convert TTL Level to CMOS Level
0	1	High Impedance (Z)

0 = Low Level      1 = High Level      X = Don't Care

Z = High Impedance on both CMOS and TTL sides.

See Operating and Handling Considerations — Bypassing and Unused Inputs.

# CD40116 Types

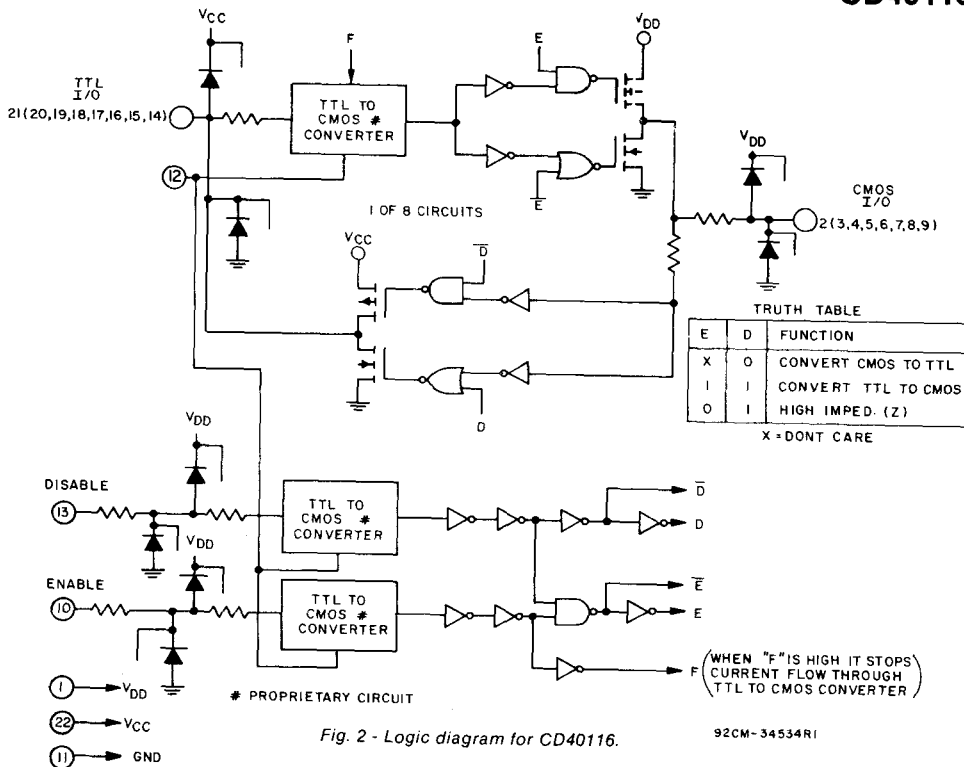

Fig. 2 - Logic diagram for CD40116.

92CM-34534R1

## STATIC CHARACTERISTICS $V_{DD} = 12\text{ V}$ , $V_{CC} = 5\text{ V}$

CHARACTERISTIC	TEST CONDITIONS	Limits at Indicated Temperatures ( $^{\circ}\text{C}$ )						UNITS	
		Values at -55, +25, +125 for D, H Packages				Values at -40, +25, +85 for E Packages			
		-55	-40	+85	+125	+25		MIN.	TYP.
Quiescent Device Current, From $V_{DD}$ Supply, $I_{DD}\text{ MAX}$	ENABLE = 1	5	5	5	5	—	1	5	mA
	ENABLE = 0	5	5	5	5	—	0.2	5	
From $V_{CC}$ Supply, $I_{CC}\text{ MAX}$		100	100	200	200	—	5	100	$\mu\text{A}$
<b>Data Flow — CMOS Inputs to TTL Outputs</b>									
Input Current, $I_{IN}\text{ MAX}$	$V_{IN} = 0, 12\text{ V};$ Any CMOS input	$\pm 60$	$\pm 60$	$\pm 60$	$\pm 60$	—	$\pm 5$	$\pm 60$	$\mu\text{A}$
Output Current, $I_{OH}\text{ MIN}$	$V_{OH} = 3\text{ V},$ $V_{IL} = 2\text{ V}$	-7.5	-7	-4.9	-4.2	-6	-12	—	mA
	$V_{OL} = 0.4\text{ V},$ $V_{IH} = 10\text{ V}$	7.5	7	4.9	4.2	6	11	—	
TTL 3-State Output Leakage Current, $I_{OUT}\text{ MAX}$	ENABLE = 1	-500	-500	-500	-500	—	-250	-500	$\mu\text{A}$
	ENABLE = 0	$\pm 100$	$\pm 100$	$\pm 100$	$\pm 100$	—	$\pm 5$	$\pm 100$	$\mu\text{A}$
<b>Data Flow — TTL Inputs to CMOS Outputs</b>									
Input Current, $I_{IL}\text{ MAX}$	$V_{IL} = 0\text{ to }0.7\text{ V};$ $V_{IH} = 2.3\text{ V};$ $V_{IH} = 5\text{ V};$ Any TTL input	-500	-500	-500	-500	—	-250	-500	$\mu\text{A}$
		-450	-350	-350	-350	—	-175	-350	
		+100	+100	+100	+100	—	+50	+100	
Output Current, $I_{OH}\text{ MIN}$	$V_{OH} = 11.5\text{ V},$ $V_{IL} = 0.7\text{ V}$	-4.3	-4.2	-2.9	-2.5	-3.5	-6.5	—	mA
	$V_{OL} = 0.5\text{ V},$ $V_{IH} = 2.3\text{ V}$	4.3	4.2	2.9	2.5	3.5	6.5	—	
CMOS 3-State Output Leakage Current, $I_{OUT}\text{ MAX}$	$V_O = 0, 12\text{ V},$ $V_{IN} = 0, 5\text{ V}$	$\pm 60$	$\pm 60$	$\pm 60$	$\pm 60$	—	$\pm 5$	$\pm 60$	$\mu\text{A}$
<b>Enable and Disable Inputs</b>									
Input Current, $I_{IL}\text{ MAX}$	$V_{IL} = 0\text{ to }0.7\text{ V}$ $V_{IH} = 2.3\text{ (TTL)}$ $V_{IH} = 12\text{ V (CMOS)}$	-500	-500	-500	-500	—	-250	-500	$\mu\text{A}$
		-450	-350	-350	-350	—	-175	-350	
		60	60	60	60	—	5	60	

# CD40116 Types

DYNAMIC ELECTRICAL CHARACTERISTICS AT  $T_A = 25^\circ\text{C}$ ;  $V_{DD} = 12\text{ V}$ ,  $V_{CC} = 5\text{ V}$

CHARACTERISTIC	TEST CONDITIONS		LIMITS			UNITS
	INPUT	OUTPUT	$C_L = 50\text{ pF}$		$C_L = 200\text{ pF}$	
			TYP	MAX	TYP	
Propagation Delay Times, Data-In to Data-Out, $t_{PHL}$ , $t_{PLH}$	CMOS TTL	TTL CMOS	25 30	35 45	35 50	ns
Disable to TTL Out, $t_{PHZ/LZ}$ $t_{PZH/ZL}$			30 35	45 50	30 35	ns
Enable to CMOS Out, $t_{PHZ/LZ}$ $t_{PZH/ZL}$			20 45	30 60	20 45	ns
Transition Time, $t_{THL}$ , $t_{TLH}$	CMOS TTL	TTL CMOS	20 20	40 40	55 55	ns

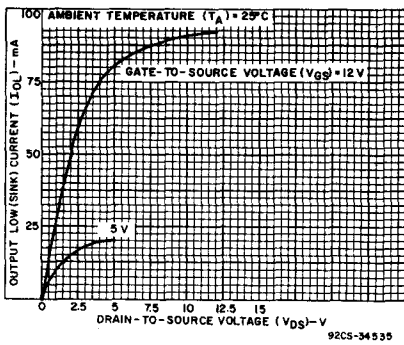

Fig. 3 - Typical N-Channel output low (sink) current characteristics - CMOS to TTL.

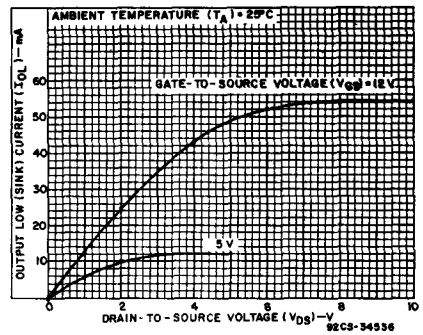

Fig. 4 - Typical output low (sink) current characteristics - TTL to CMOS.

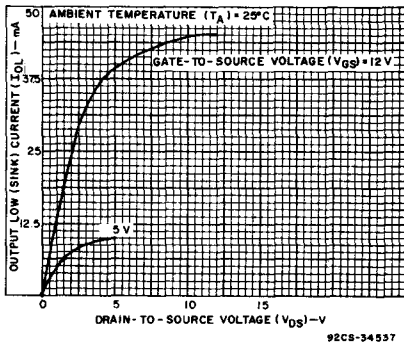

Fig. 5 - Minimum N-Channel output low (sink) current characteristics - CMOS

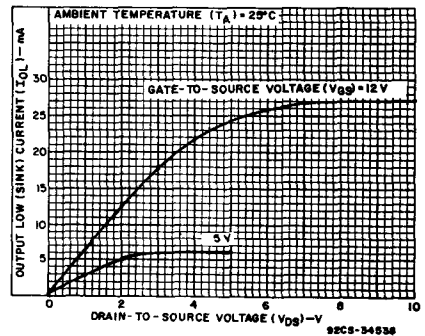

Fig. 6 - Minimum output low (sink) current characteristics - TTL to CMOS.

# CD40116 Types

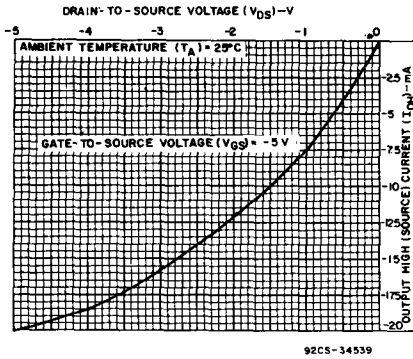

Fig. 7 - Typical P-channel output high (source) current characteristics - CMOS to TTL.

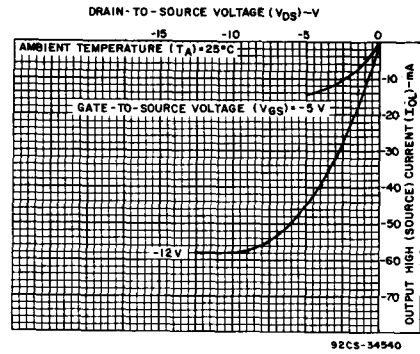

Fig. 8 - Typical output high (source) current characteristics - TTL to CMOS.

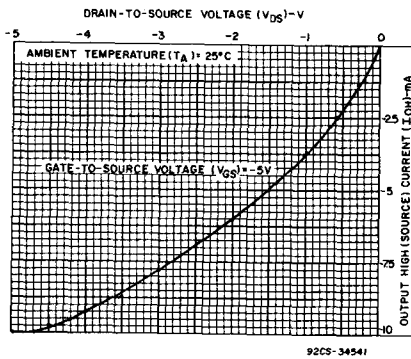

Fig. 9 - Minimum P-Channel output high (source) current characteristic - CMOS to TTL.

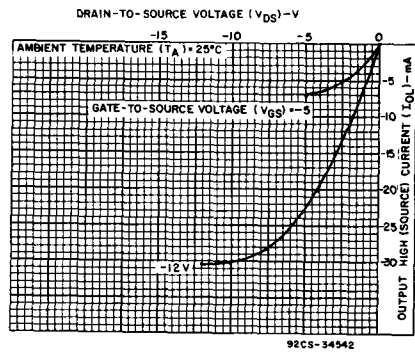

Fig. 10 - Minimum output high (source) current characteristics - TTL to CMOS.

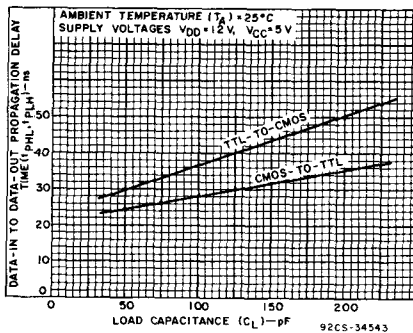

Fig. 11 - Typical DATA-IN to DATA-OUT propagation delay as a function of load capacitance.

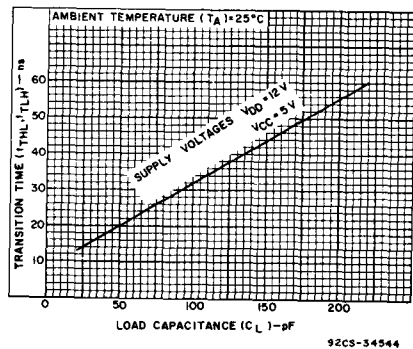

Fig. 12 - Typical transition time as a function of load capacitance CMOS-to-TTL or TTL-to-CMOS.

# CD40116 Types

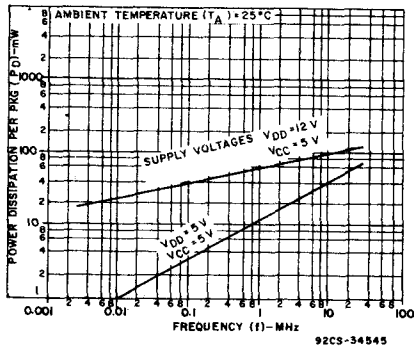

Fig. 13 - Power dissipation as a function of frequency - CMOS to TTL.

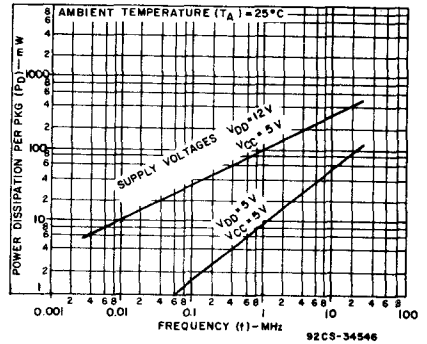
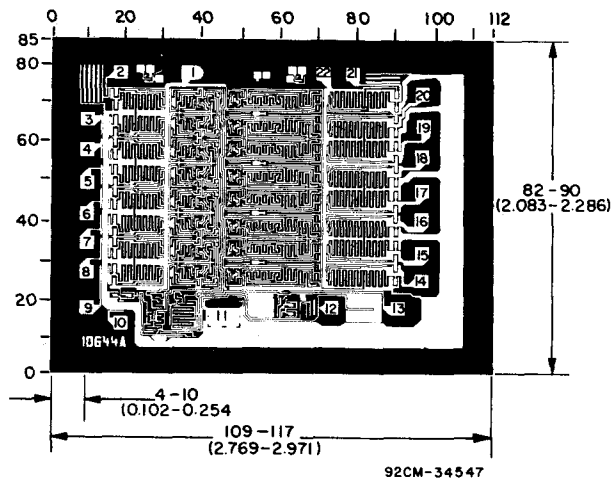

Fig. 14 - Power dissipation as a function of frequency - TTL to CMOS.



The photographs and dimensions of each CMOS chip represent a chip when it is part of the wafer. When the wafer is separated into individual chips, the angle of cleavage may vary with respect to the chip face for different chips. The actual dimensions of the isolated chip, therefore, may differ slightly from the nominal dimensions shown. The user should consider a tolerance of  $-3$  mils to  $+16$  mils applicable to the nominal dimensions shown.

Dimensions in parentheses are in millimeters and are derived from the basis inch dimensions as indicated. Grid graduations are in mils ( $10^{-3}$  inch).

## Dimensions and Pad Layout for CD40116H



---

# High-Reliability CMOS IC's

# RCA High-Reliability CMOS IC's

## MIL-M-38510 CD4000-Series CMOS IC's

The purpose of the MIL-M-38510 program is to achieve standardization among integrated-circuit suppliers and to assure delivery of devices whose long-term life will satisfy the requirements of the system for which they are intended. Three reliability classes — S, B, and C — are described in MIL-M-38510; the screening tests for these reliability classes are performed according to MIL-STD-883, Method 5004. Class S devices are of the highest reliability level and are intended for critical applications where replacement of components is not practical.

The qualification and quality conformance tests delineated in MIL-STD-883, Method 5005 are accelerated stress tests that subject devices to stress levels greater than those nor-

mally experienced in a typical application. These tests consist of: Group A, Electrical; Group B, Package and Internal Mechanical Strength; Group C, Indicators of Long Term Reliability; and Group D for package and chip. Both qualification devices and a sample of devices from the production line are subjected to this series of accelerated tests. The tests performed on the qualification devices are called qualification tests; the tests performed on production-line devices after a specific type has been qualified are called conformance tests. Electrical end-point limits for the tests are defined by MIL-M-38510 and are more demanding of CMOS than of TTL. DC parameters are measured at -55°C, +25°C, and +125°C.

### RCA JAN Qualified-Parts Listing as of Jan. 1982

Detail Specification	RCA Type	Available JAN Devices			Detail Specification	RCA Type	Available JAN Devices		
		S	B	1 x 10 <sup>5</sup> Rad Si			S	B	1 x 10 <sup>5</sup> Rad Si
MIL-M-38510/5001	CD4011A		A		MIL-M-38510/5701	CD4006A		A	
02	CD4012A		A		02	CD4014A		A	
03	CD4023A		A		03	CD4015A		A	
51	CD4011B		P	P	04	CD4021A		A	
52	CD4012B		P	P	05	CD4031A		A	
53	CD4023B		P	P	06	CD4034A			
MIL-M-38510/5101	CD4013A		A		51	CD4006B			
02	CD4027A		A		52	CD4014B			
03	CD4043A				53	CD4015B			
51	CD4013B		P	P	54	CD4021B			
52	CD4027B				55	CD4031B			
53	CD4043B				56	CD4034B			
MIL-M-38510/5201	CD4000A		A		MIL-M-38510/5801	CD4016A			
02	CD4001A		A		02	CD4066A			
03	CD4002A		A		51	CD4016B			
04	CD4025A		A		52	CD4066B			
51	CD4000B				MIL-M-38510/5901	CD4028A			
52	CD4001B		P	P	51	CD4028B			
53	CD4002B		P	P	MIL-M-38510/17001	CD4081B	A	A	A
54	CD4025B				02	CD4082B	A	A	A
MIL-M-38510/5301	CD4007A		A		03	CD4073B	A	A	A
02	CD4019A		A		MIL-M-38510/17101	CD4071B	A	A	A
03	CD4030A				02	CD4072B	A	A	A
04	CD4048A				03	CD4075B	A	A	A
51	CD4007B				MIL-M-38510/17201	CD4085B	A	A	A
52	CD4019B				02	CD4086B	A	A	A
53	CD4030B				03	CD4070B	A	A	A
54	CD4048B				04	CD4077B	A	A	A
MIL-M-38510/5401	CD4008A				MIL-M-38510/17301	CD4514B			
51	CD4008B				02	CD4515B			
MIL-M-38510/5501	CD4009A				03	CD4532B			
02	CD4010A				04	CD4555B			
03	CD4049A		A		05	CD4556B			
04	CD4050A		A		MIL-M-38510/17401	CD4069UB	A	A	A
05	CD4041A				02	CD40107B			
51	CD4009UB				03	CD4502B	A	A	A
52	CD4010B				04	CD40109B			
53	CD4049UB		P	P	MIL-M-38510/17501	CD4076B			
54	CD4050B		P	P	02	CD4095B			
55	CD4041B		P	P	03	CD4096B			
MIL-M-38510/5601	CD4017A		A		04	CD4098B	A	A	A
02	CD4018A		A		05	CD40174B			
03	CD4020A		A		MIL-M-38510/17601	CD4099B	A	A	A
04	CD4022A		A		02	CD4508B			
05	CD4024A		A		MIL-M-38510/17701	CD4093B			
51	CD4017B		P	P	02	CD40106B			
52	CD4018B				MIL-M-38510/17801	CD4067B			
53	CD4020B		P	P	02	CD4097B			
54	CD4022B				03	CD40257B			
55	CD4024B								

A = available P = proposed qual.

# RCA High-Reliability CMOS IC's

## Standard-Product and Special Custom High-Reliability IC's

RCA offers high-reliability versions of virtually its entire line of standard-product integrated circuits from the CD4000 series of CMOS digital logic types to the CDP1800 series microprocessor, associated memory, and input/output (I/O) types. These integrated circuits are processed and screened to MIL-STD-883 Class B requirements.

RCA also offers high-reliability versions of standard-product types that are processed and screened to special customized specifications, especially for the aerospace user

and others who procure types to Class S specifications.

RCA maintains an extensive computer file of customer specifications and has the methodology required to translate these customized specifications into internal RCA standards and factory operating procedures. In addition to the detailed device specifications, the computer file lists the customer specification number, any revision number, and the RCA custom number assigned to a specific device type.

## RCA MIL-STD-883 Slash-Series CMOS IC's

RCA high-reliability slash-series CMOS products include both CD4000-series digital logic types and CDP1800-series microprocessor and memory-system types. The CD4000-series parts are provided to three screening levels—/1S, /3, and /3W—that correspond to MIL-STD-883, Method 5004, Classes S and B requirements. The CDP1800-series parts are supplied to levels /3 and /3W. Equivalent aerospace level screening may be negotiated on a custom basis. RCA also

supplies high-reliability chips. These chips are provided to two screening levels, /S (or /R for LSI types) and /M.

RCA CD4000-series level /1S packaged devices and /S chips are also available in radiation-hardened versions. These parts are processed to either  $10^5$  or  $10^6$  rads(Si) and are identified by addition of a "Z" or a "J" suffix letter, respectively, to the device type number (see nomenclature diagram on following page).

## Screening Levels for RCA MIL-STD-883 Slash-Series CMOS Integrated Circuits

Screening Levels		Application	Description
RCA Levels	MIL-STD-883, Method 5004 Format		
<b>Packaged Devices (D, F, K, or L Suffix)</b>			
/1S	Class S with SEM Inspection and Condition A Precap Visual Inspection	Aerospace and Missiles	For devices intended for use where maintenance and replacement are impossible and reliability is imperative
/1R*	Class S with SEM Inspection and Condition B Precap Visual Inspection (for LSI types)		
/1SJ or /1RJ*	Same as /1S or /1R + Radiation Hardened to $10^6$ rads(Si)		
/1SZ or /1RZ*	Same as /1S or /1R + Radiation Hardened to $10^6$ rads(Si)		
/3	Class B	Military and Industrial For example, In Airborne Electronics	For devices intended for use where maintenance and replacement can be performed but are difficult and expensive
/3W‡	Class B with High- and Low-Temperature DC and Dynamic Testing omitted		
<b>Chips (H Suffix)</b>			
/S	SEM Inspection and Condition A Visual Inspection	Aerospace and Missiles	For hybrid applications where maintenance and replacement are extremely difficult and reliability is imperative
/R*	SEM Inspection and Condition B Visual Inspection (for LSI types)		
/SJ or /RJ*	Same as /S or /R + Radiation Hardened to $10^6$ rads(Si)		
/SZ or /RZ*	Same as /S or /R + Radiation Hardened to $10^6$ rads(Si)		
/M	Condition B Precap Visual Inspection	Military and Industrial	For general applications

\* /1R or /R screening is used instead of /1S or /S screening for LSI circuits for which their large size makes the Condition A Precap Visual Inspection impractical.

‡ /3W Screening of CDP1800-series includes dynamic testing at 25°C.

# RCA High-Reliability CMOS IC's

## Nomenclature for High-Reliability CMOS IC's

The type number for RCA slash-series CMOS integrated circuits identifies not only the basic device, but also the screening level, package, and lead finish. The package is identified by addition of a suffix letter D (dual-in-line welded-seal ceramic), F (dual-in-line frit-seal ceramic), K (ceramic flat pack), or H (chips) to the basic type number. The screening level is identified by addition of /1S; /1R, /3, /3W for packaged

devices or /S, /R, or /M for chips. A J or Z suffix to level /1S or /S parts indicates radiation-hardened types.

Similarly, the MIL-M-38510 type number is a guide to the detailed electrical specification, the basic device type, the reliability class, and lead finish.

### Guide to the reliability class, package, and radiation-hardness assurance level of RCA high-reliability (slash-series) CMOS integrated circuits processed to MIL-STD-883 Format.

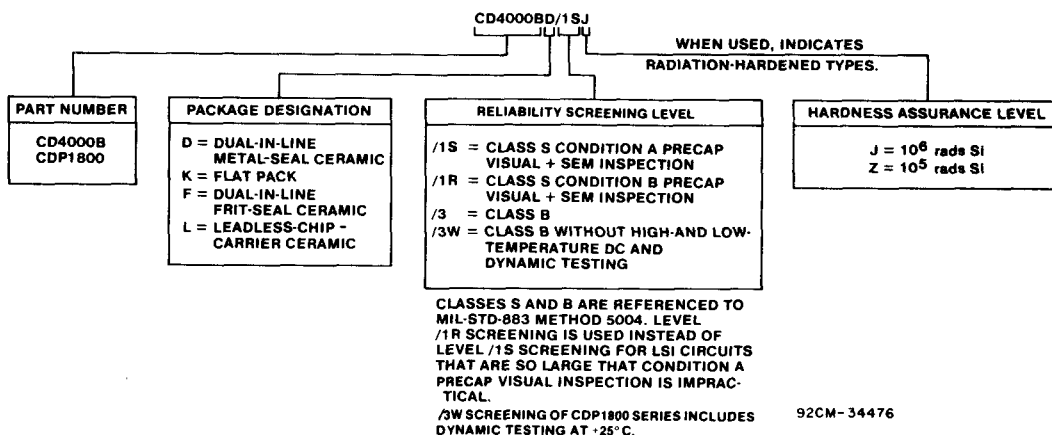

### Guide to the reliability class, package, lead finish, radiation-hardness assurance level, and electrostatic sensitivity of RCA high-reliability CMOS integrated circuits processed in accordance with MIL-M-38510.

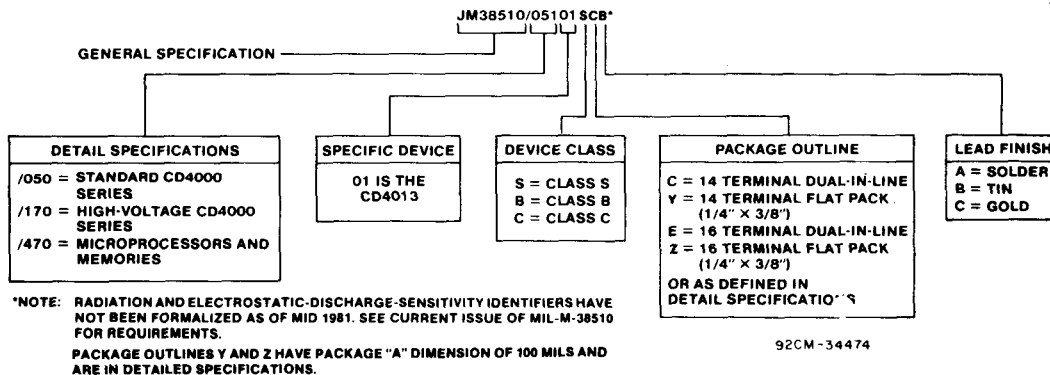

# RCA High-Reliability CMOS IC's

## High-Voltage CD4000B-Series CMOS IC's

Type No.	Description	No. of Leads	Type No.	Description	No. of Leads
CD4000B	Dual 3-input NOR gate plus inverter	14	CD4066B	Quad bilateral switch	14
CD4000UB	Dual 3-input NOR gate plus inverter	14	CD4067B	16-channel analog multiplexers/demultiplexers	24
CD4001B	Quad 2-input NOR gate	14	CD4068B	8-input NAND/AND gate	14
CD4001UB	Quad 2-input NOR gate	14	CD4069UB	Hex inverter	14
CD4002B	Dual 4-input NOR gate	14	CD4070B	Quad exclusive-OR gate	14
CD4002UB	Dual 4-input NOR gate	14	CD4071B	Quad 2-input OR gate	14
CD4006B	18-stage static shift register	14	CD4072B	Dual 4-input OR gate	14
CD4007UB	Dual complementary pair plus inverter	14	CD4073B	Triple 3-input AND gate	14
CD4008B	4-bit full adder with parallel carry-out	16	CD4075B	Triple 3-input OR gate	14
CD4009UB	Hex buffer/convertor (inverting)	16	CD4076B	4-bit "D" flip-flop (3-state outputs)	14
CD4010B	Hex buffer/convertor (non-inverting)	16	CD4077B	Quad exclusive-NOR gate	14
CD4011B	Quad 2-input NAND gate	14	CD4078B	8-input NOR/OR gate	14
CD4011UB	Quad 2-input NAND gate	14	CD4081B	Quad 2-input AND gate	14
CD4012B	Dual 4-input NAND gate	14	CD4082B	Dual 4-input AND gate	14
CD4012UB	Dual 4-input NAND gate	14	CD4085B	Dual 2-wide, 2-input AND/OR INVERT (AO1) gate	14
CD4013B	Dual "D" flip-flop with set/reset capability	14	CD4086B	Expandable 4-wide, 2-input AND/OR/INVERT (AO1) gate	14
CD4014B	8-stage static shift register	16	CD4089B	Binary rate multiplier	16
CD4015B	Dual 4-stage static shift register	16	CD4093B	Quad 2-input NAND Schmitt Trigger	14
CD4016B	Quad bilateral switch	14	CD4094B	8-stage shift-and-store bus register	16
CD4017B	Decade counter/divider	16	CD4095B	Gated "J-K" flip-flop (non-inverting)	14
CD4018B	Presetable divide-by "N" counter	16	CD4096B	Gated "J-K" flip-flop (inverting and non-inverting)	14
CD4019B	Quad AND/OR select gate	16	CD4097B	8-channel analog multiplexer/demultiplexer	24
CD4020B	14-stage Binary Ripple Counter	16	CD4098B	Dual monostable multivibrator	16
CD4021B	8-stage static shift register	16	CD4099B	8-bit addressable latch	16
CD4022B	Divide-by-8 counter/divider	16	CD4502B	Strobed hex inverter/buffer	16
CD4023B	Triple 3-input NAND gate	14	CD4503B	Hex buffer (non-inverting)	16
CD4023UB	Triple 3-input NAND gate	14	CD4508B	Dual 4-bit latch	24
CD4024B	7-stage binary ripple counter	14	CD4510B	Presetable 4-bit BCD up/down counter	16
CD4025B	Triple 3-input NOR gate	14	CD4511B	BCD-to-7-segment latch decoder/driver	16
CD4025UB	Triple 3-input NOR gate	14	CD4512B	8-channel data selector (3-state output)	16
CD4026B	Decade counter/divider	16	CD4514B	4-bit latch/4-to-16 line decoder (outputs low)	24
CD4027B	Dual "J-K" flip-flop with set/reset capability	16	CD4515B	4-bit latch/4-to-16 line decoder (outputs low)	24
CD4028B	BCD-to-decimal decoder	16	CD4516B	Presetable 4-bit binary up/down counter	16
CD4029B	Presetable up/down counter	16	CD4517B	Dual 64-bit shift register	16
CD4030B	Quad exclusive-OR gate	14	CD4518B	Dual BCD up counter	16
CD4031B	64-stage static shift register	16	CD4520B	Dual binary up counter	16
CD4033B	Decade counter/divider	16	CD4527B	BCD rate multiplier	16
CD4034B	8-stage static shift register	24	CD4532B	8-input priority encoder	16
CD4035B	4-stage parallel-in/parallel-out shift register	16	CD4536B	Programmable timer	16
CD4040B	12-stage binary ripple counter	16	CD4538B	Dual precision monostable multivibrator	16
CD4041UB	Quad true/complement buffer	14	CD4555B	Dual 1-of-4 decoder/demultiplexer (outputs high)	16
CD4042B	Quad clocked "D" latch	16	CD4556B	Dual 1-of-4 decoder/demultiplexer (outputs low)	16
CD4043B	Quad NOR R/S latch (3-state outputs)	16	CD4585B	4-bit magnitude comparator	16
CD4044B	Quad NAND R/S latch (3-state outputs)	16	CD4724B	8-bit addressable latch	16
CD4045B	21-stage timer	14	CD40100B	32-bit left/right shift register	16
CD4046B	Micropower phase-locked loop	16	CD40101B	9-bit parity generator/checker	14
CD4047B	Monostable/astable multivibrator	14	CD40102B	Presetable 2-decade BCD down counter	16
CD4048B	Multifunctional expandable 8-input gate (3-state output)	16	CD40103B	Presetable 8-bit binary down counter	16
CD4049UB	Hex buffer/convertor (inverting)	16	CD40104B	4-bit bidirectional universal shift register	16
CD4050B	Hex buffer/convertor (non-inverting)	16	CD40105B	4-bit x 16 word FiFo buffer register	16
CD4051B	8-channel analog multiplexer/demultiplexer	16			
CD4052B	4-channel analog multiplexer/demultiplexer	16			
CD4053B	Triple 2-channel analog multiplexer/demultiplexer	16			
CD4060B	14-stage binary ripple counter/divider and oscillator	16			
CD4063B	4-bit magnitude comparator	16			

# RCA High-Reliability CMOS IC's

## High-Voltage CD4000B-Series CMOS IC's (Cont'd)

Type No.	Description	No. of Leads
CD40106B	Hex Schmitt Trigger	14
CD40107B	Dual 2-input NAND buffer/driver	14
CD40108B	4 x 4 multiport register	24
CD40109B	Quad low-to-high voltage interface	16
CD40110B	Decade up/down counter/ decoder/latch/driver	16
CD40147B	10-line to 4-line BCD priority encoder	16
CD40160B	Decade counter with asynchronous clear	16
CD40161B	Binary counter with asynchronous clear	16
CD40162B	Decade counter with synchronous clear	16

Type No.	Description	No. of Leads
CD40163B	Binary counter with synchronous clear	16
CD40174B	Hex "D" flip-flop	16
CD40181B	4-bit arithmetic logic unit	24
CD40182B	Look-ahead-carry block	16
CD40192B	Presetable 4-bit BCD up/down counter	16
CD40193B	Presetable 4-bit binary up/down counter	16
CD40194B	4-bit bidirectional universal shift register	16
CD40208B	4 x 4 multiport register	24
CD40257B	Quad 2-line-to-1-line data selector	16

**Note:**

RCA also offers high-reliability versions of a number of the A-series (3 to 12V) counterparts (CD4000A through CD4050A and CD4060A) of the high-voltage B-series types listed above and of several A-series types for which there are no corresponding B-series types (i.e., CD4036A and CD4039A RAM's, CD4057 A ALU, and CD4059 A programmable divide-by-N counter).

## Radiation-Resistant CD4000-Series CMOS IC's

RCA offers radiation-hardened CD4000-series CMOS integrated circuits capable of withstanding total ionizing radiation dosages of  $10^5$  rads(Si)—Z-suffix types—or  $10^6$  rads(Si)—J-suffix types. These radiation-hardened types are processed to either MIL-M-38510 Class S or MIL-STD-883 level /1S. In addition, these types are subjected to special process controls in which their radiation tolerance is monitored. Samples are exposed to specified total radiation dosages from a Cobalt 60 source, pre- and post-radiation measurements are made of threshold, threshold delta, leakage current, and go, no-go functional tests.

The radiation resistance to the specified levels is verified by exposure of two packaged devices per wafer for SSI, MSI-1, and MSI-2 types and a varied quantity of packaged devices per lot for LSI types, depending on their complexity.

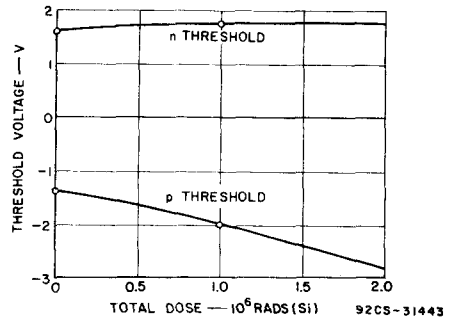

Typical threshold-voltage variations of RCA MEGARAD CD4000-series CMOS integrated circuits as a function of total-dose gamma radiation.

---

# Dimensional Outlines

# Dimensional Outlines

## Dual-In-Line Welded-Seal Ceramic Packages

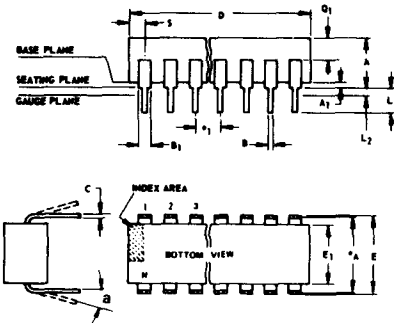

- NOTES:**  
Refer to Rules for Dimensioning (JEDEC Publication No. 95) for Axial Lead Product Outlines.
- When this device is supplied solder-dipped, the maximum lead thickness (narrow portion) will not exceed 0.013" (0.33 mm).
  - Leads within 0.005" (0.12 mm) radius of True Position (TP) at gauge plane with maximum material condition and unit installed.
  - eA applies in zone L<sub>2</sub> when unit installed.
  - a applies to spread leads prior to installation.
  - N is the maximum quantity of lead positions.
  - N<sub>1</sub> is the quantity of allowable missing leads.

**(D) SUFFIX (JEDEC MO-001-AD)**  
14-Lead Dual-In-Line Welded-Seal Ceramic Package

SYMBOL	INCHES		NOTE	MILLIMETERS	
	MIN.	MAX.		MIN.	MAX.
A	0.120	0.160		3.05	4.06
A <sub>1</sub>	0.020	0.065		0.51	1.65
B	0.014	0.020		0.356	0.508
B <sub>1</sub>	0.050	0.065		1.27	1.65
C	0.008	0.012	1	0.204	0.304
D	0.745	0.770		18.93	19.55
E	0.300	0.325		7.62	8.25
E <sub>1</sub>	0.240	0.260		6.10	6.60
e <sub>1</sub>	0.100 TP		2	2.54 TP	
e <sub>A</sub>	0.300 TP		2, 3	7.62 TP	
L	0.125	0.150		3.18	3.81
L <sub>2</sub>	0.000	0.030		0.000	0.76
a	0°	15°	4	0°	15°
N	14		5	14	
N <sub>1</sub>	0		6	0	
Q <sub>1</sub>	0.050	0.085		1.27	2.15
S	0.065	0.090		1.66	2.28

92SS-4411R2

**(D) SUFFIX (JEDEC MO-001-AE)**  
16-Lead Dual-In-Line Welded-Seal Ceramic Package

SYMBOL	INCHES		NOTE	MILLIMETERS	
	MIN.	MAX.		MIN.	MAX.
A	0.120	0.160		3.05	4.06
A <sub>1</sub>	0.020	0.065		0.51	1.65
B	0.014	0.020		0.356	0.508
B <sub>1</sub>	0.035	0.065		0.89	1.65
C	0.008	0.012	1	0.204	0.304
D	0.745	0.785		18.93	19.93
E	0.300	0.325		7.62	8.25
E <sub>1</sub>	0.240	0.260		6.10	6.60
e <sub>1</sub>	0.100 TP		2	2.54 TP	
e <sub>A</sub>	0.300 TP		2, 3	7.62 TP	
L	0.125	0.150		3.18	3.81
L <sub>2</sub>	0.000	0.030		0.000	0.76
a	0°	15°	4	0°	15°
N	16		5	16	
N <sub>1</sub>	0		6	0	
Q <sub>1</sub>	0.050	0.085		1.27	2.15
S	0.015	0.060		0.39	1.52

92SS-4286R5

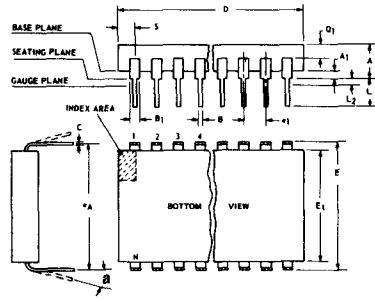

- NOTES:**  
Refer to Rules for Dimensioning (JEDEC Publication No. 95) for Axial Lead Product Outlines.
- When this device is supplied solder-dipped, the maximum lead thickness (narrow portion) will not exceed 0.013" (0.33 mm).
  - Leads within 0.005" (0.12 mm) radius of True Position (TP) at gauge plane with maximum material condition and unit installed.
  - eA applies in zone L<sub>2</sub> when unit installed.
  - a applies to spread leads prior to installation.
  - N is the maximum quantity of lead positions.
  - N<sub>1</sub> is the quantity of allowable missing leads.

**(D) SUFFIX (JEDEC MO-015-AG)**  
24-Lead Dual-In-Line Welded-Seal Ceramic Package

SYMBOL	INCHES		NOTE	MILLIMETERS	
	MIN.	MAX.		MIN.	MAX.
A	0.090	0.200		2.29	5.08
A <sub>1</sub>	0.020	0.070		0.51	1.78
B	0.015	0.020		0.381	0.508
B <sub>1</sub>	0.045	0.055		1.143	1.397
C	0.008	0.012	1	0.204	0.304
D	1.15	1.22		29.21	30.98
E	0.600	0.625		15.24	15.87
E <sub>1</sub>	0.480	0.520		12.20	13.20
e <sub>1</sub>	0.100 TP		2	2.54 TP	
e <sub>A</sub>	0.600 TP		2, 3	15.24 TP	
L	0.100	0.180		2.54	4.57
L <sub>2</sub>	0.000	0.030		0.00	0.76
a	0°	15°	4	0°	15°
N	24		5	24	
N <sub>1</sub>	0		6	0	
Q <sub>1</sub>	0.020	0.080		0.51	2.03
S	0.020	0.060		0.51	1.52

92CS-1994BR4

**(D) SUFFIX (JEDEC MO-015-AH)**  
28-Lead Dual-In-Line Welded-Seal Ceramic Package

SYMBOL	INCHES		NOTE	MILLIMETERS	
	MIN.	MAX.		MIN.	MAX.
A	0.090	0.200		2.29	5
A <sub>1</sub>	0	0.070	2	0	1.77
B	0.015	0.020		0.381	0.508
B <sub>1</sub>	0.015	0.055		0.39	1.39
C	0.008	0.012	1	0.204	0.304
D	1.380	1.420		35.06	36.06
E	0.600	0.625		15.24	15.87
E <sub>1</sub>	0.485	0.515		12.32	13.08
e <sub>1</sub>	0.100 TP		2	2.54 TP	
e <sub>A</sub>	0.600 TP		2, 3	15.24 TP	
L	0.100	0.200		2.5	5
L <sub>2</sub>	0	0.030		0	0.76
a	0°	15°	4	0°	15°
N	28		5	28	
N <sub>1</sub>	0		6	0	
Q <sub>1</sub>	0.020	0.070		0.51	1.77
S	0.040	0.070		1.02	1.77

92CM-20250R2

## TO-5 Style Package

**(T) SUFFIX (JEDEC MO-006-AG)**  
12-Lead Metal Package

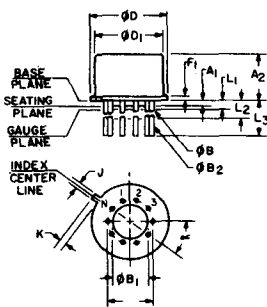

92CS-1977A

SYMBOL	INCHES		NOTE	MILLIMETERS	
	MIN.	MAX.		MIN.	MAX.
a	0.230		2	5.84 TP	
A <sub>1</sub>	0	0		0	0
A <sub>2</sub>	0.165	0.185		4.19	4.70
ØB	0.016	0.019	3	0.407	0.482
ØB <sub>1</sub>	0	0		0	0
ØB <sub>2</sub>	0.016	0.021	3	0.407	0.533
ØD	0.335	0.370		8.51	9.39
ØD <sub>1</sub>	0.305	0.335		7.75	8.50
F <sub>1</sub>	0.020	0.040		0.51	1.01
j	0.028	0.034		0.712	0.863
k	0.029	0.045	4	0.74	1.14
L <sub>1</sub>	0.000	0.050	3	0.00	1.27
L <sub>2</sub>	0.250	0.500	3	6.4	12.7
L <sub>3</sub>	0.500	0.562	3	12.7	14.27
a	30° TP			30° TP	
N	12		6	12	
N <sub>1</sub>	1		5	1	

**NOTES:**

- Refer to Rules for Dimensioning Axial Lead Product Outlines.
- Leads at gauge plane within 0.007" (0.178 mm) radius of True Position (TP) at maximum material condition.
- ØB applies between L<sub>1</sub> and L<sub>2</sub>. ØB<sub>2</sub> applies between L<sub>2</sub> and 0.500" (12.70 mm) from seating plane. Diameter is uncontrolled in L<sub>1</sub> and beyond 0.500" (12.70 mm).
- Measure from Max. ØD.
- N<sub>1</sub> is the quantity of allowable missing leads.
- N is the maximum quantity of lead positions.



## Dimensional Outlines (Cont'd)

### DUAL-IN-LINE SIDE-BRAZED CERAMIC PACKAGES

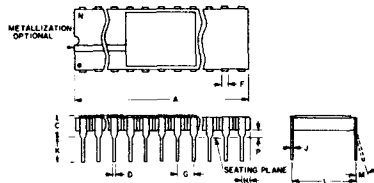

**NOTES:**

1. Leads within 0.005" (0.13 mm) radius of True Position at maximum material condition.
2. Dimension "L" to center of leads when formed parallel.
3. When this device is supplied solder-dipped, the maximum lead thickness (narrow portion) will not exceed 0.013" (0.33 mm).

### (D) SUFFIX 18-Lead Dual-In-Line Side-Brazed Ceramic Package

SYMBOL	INCHES		NOTE	MILLIMETERS	
	MIN.	MAX.		MIN.	MAX.
A	0.890	0.915		22.606	23.241
C	—	0.200		—	5.080
D	0.015	0.021		0.381	0.533
F	0.054	REF.	1	1.371	REF.
G	0.100	BSC	1	2.54	BSC
H	0.035	0.065		0.889	1.651
J	0.008	0.012	3	0.203	0.304
K	0.125	0.150		3.175	3.810
L	0.290	0.310	2	7.366	7.874
M	0°	15°		0°	15°
P	0.025	0.045		0.635	1.143
N	18			18	

92CS-27231R1

### (D) SUFFIX 22-Lead Dual-In-Line Side-Brazed Ceramic Package

SYMBOL	INCHES		NOTE	MILLIMETERS	
	MIN.	MAX.		MIN.	MAX.
A	1.065	1.100		27.05	27.94
C	0.085	0.145		2.16	3.68
D	0.017	0.023		0.43	0.56
F	0.040	REF.	1	1.02	REF.
G	0.100	BSC	1	2.54	BSC
H	0.030	0.070		0.75	1.78
J	0.008	0.012	3	0.20	0.30
K	0.125	0.175		3.18	4.45
L	0.380	0.420	2	9.65	10.67
M	—	7°		—	7°
P	0.025	0.050		0.64	1.27
N	22			22	

92CS-25186R2

### (D) SUFFIX 24-Lead Dual-In-Line Side-Brazed Ceramic Package

SYMBOL	INCHES		NOTE	MILLIMETERS	
	MIN.	MAX.		MIN.	MAX.
A	1.180	1.220		29.98	30.98
C	0.085	0.145		2.16	3.68
D	0.015	0.023		0.39	0.58
F	0.040	REF.		1.02	REF.
G	0.100	BSC	1	2.54	BSC
H	0.030	0.070		0.77	1.77
J	0.008	0.012	3	0.21	0.30
K	0.125	0.175		3.18	4.44
L	0.580	0.620	2	14.74	15.74
M	—	7°		—	7°
P	0.025	0.050		0.64	1.27
N	24			24	

92CS-30986R1

### (D) SUFFIX 40-Lead Dual-In-Line Side-Brazed Ceramic Package

SYMBOL	INCHES		NOTE	MILLIMETERS	
	MIN.	MAX.		MIN.	MAX.
A	1.980	2.020		50.30	51.30
C	0.095	0.155		2.43	3.93
D	0.017	0.023		0.43	0.56
F	0.050	REF.		1.27	REF.
G	0.100	BSC	1	2.54	BSC
H	0.030	0.070		0.76	1.78
J	0.008	0.012	3	0.20	0.30
K	0.125	0.175		3.18	4.45
L	0.580	0.620	2	14.74	15.74
M	—	7°		—	7°
P	0.025	0.050		0.64	1.27
N	40			40	

92CM-27029R2

### Dual-In-Line Plastic and Frit-Seal Ceramic Packages

#### (E) SUFFIX (JEDEC MO-001-AN) 8-Lead Dual-In-Line Plastic (Mini-DIP) Package

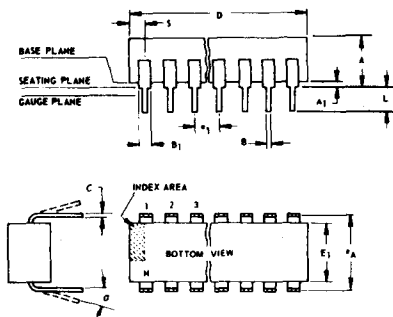

SYMBOL	INCHES		NOTE	MILLIMETERS	
	MIN.	MAX.		MIN.	MAX.
A	0.155	0.200		3.94	5.08
A <sub>1</sub>	0.020	0.050		0.508	1.27
B	0.014	0.020		0.356	0.508
B <sub>1</sub>	0.035	0.065		0.889	1.65
C	0.008	0.012	1	0.203	0.304
D	0.370	0.400		9.40	10.16
E	0.300	0.325		7.62	8.25
E <sub>1</sub>	0.240	0.260		6.10	6.60
e <sub>1</sub>	0.100 TP		2	2.54 TP	
e <sub>A</sub>	0.300 TP		2, 3	7.62 TP	
L	0.125	0.150		3.18	3.81
L <sub>2</sub>	0.000	0.030		0.000	0.762
B	0	15	4	0	15
N	8		5	8	
N <sub>1</sub>	0		6	0	
Q <sub>1</sub>	0.040	0.075		1.02	1.90
S	0.015	0.060		0.381	1.52

92CS-24026R1

**NOTES:**

Refer to Rules for Dimensioning (JEDEC Publication No. 95) for Axial Lead Product Outlines.

1. When this device is supplied solder-dipped, the maximum lead thickness (narrow portion) will not exceed 0.013".
2. Leads within 0.005" (0.12 mm) radius of True Position (TP) at gauge plane with maximum material condition and unit installed.
3. e<sub>A</sub> applies in zone L<sub>2</sub> when unit installed.
4. a applies to spread leads prior to installation.
5. N is the maximum quantity of lead positions.
6. N<sub>1</sub> is the quantity of allowable missing leads.

# Dimensional Outlines (Cont'd)

## Dual-In-Line Plastic and Frit-Seal Ceramic Packages (Cont'd)

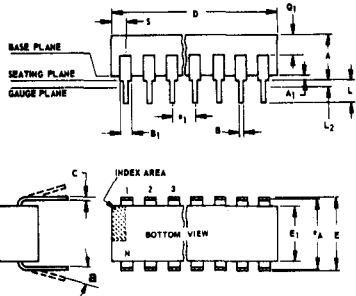

NOTES:  
Refer to Rules for Dimensioning (JEDEC Publication No. 95) for Axial Lead Product Outlines.

- When this device is supplied solder-dipped, the maximum lead thickness (narrow portion) will not exceed 0.013" (0.33 mm).
- Leads within 0.005" (0.12 mm) radius of True Position (TP) at gauge plane with maximum material condition and unit installed.
- e<sub>A</sub> applies in zone L<sub>2</sub> when unit installed.
- a applies to spread leads prior to installation.
- N is the maximum quantity of lead positions.
- N<sub>1</sub> is the quantity of allowable missing leads.

### (E) and (F) SUFFIXES (JEDEC MO-001-AB) 14-Lead Dual-In-Line Plastic or Frit-Seal Ceramic Package

SYMBOL	INCHES		NOTE	MILLIMETERS	
	MIN.	MAX.		MIN.	MAX.
A	0.155	0.200		3.94	5.08
A <sub>1</sub>	0.020	0.050		0.51	1.27
B	0.014	0.020		0.356	0.508
B <sub>1</sub>	0.050	0.065		1.27	1.65
C	0.008	0.012	1	0.204	0.304
D	0.745	0.770		18.93	19.55
E	0.300	0.325		7.62	8.25
E <sub>1</sub>	0.240	0.260		6.10	6.60
e <sub>1</sub>	0.100 TP		2	2.54 TP	
e <sub>A</sub>	0.300 TP		2, 3	7.62 TP	
L	0.125	0.150		3.18	3.81
L <sub>2</sub>	0.000	0.030		0.000	0.76
a	0°	15°	4	0°	15°
N	14		5	14	
N <sub>1</sub>	0		6	0	
Q <sub>1</sub>	0.040	0.075		1.02	1.90
S	0.065	0.090		1.66	2.28

92SS-4296R3

### (E) and (F) SUFFIXES (JEDEC MO-001-AC) 16-Lead Dual-In-Line Plastic or Frit-Seal Ceramic Package

SYMBOL	INCHES		NOTE	MILLIMETERS	
	MIN.	MAX.		MIN.	MAX.
A	0.155	0.200		3.94	5.08
A <sub>1</sub>	0.020	0.050		0.51	1.27
B	0.014	0.020		0.356	0.508
B <sub>1</sub>	0.035	0.065		0.89	1.65
C	0.008	0.012	1	0.204	0.304
D	0.745	0.785		18.93	19.93
E	0.300	0.325		7.62	8.25
E <sub>1</sub>	0.240	0.260		6.10	6.60
e <sub>1</sub>	0.100 TP		2	2.54 TP	
e <sub>A</sub>	0.300 TP		2, 3	7.62 TP	
L	0.125	0.150		3.18	3.81
L <sub>2</sub>	0.000	0.030		0.000	0.76
a	0°	15°	4	0°	15°
N	16		5	16	
N <sub>1</sub>	0		6	0	
Q <sub>1</sub>	0.040	0.075		1.02	1.90
S	0.015	0.060		0.39	1.52

92CM-15967R4

### (E) SUFFIX 18-Lead Dual-In-Line Plastic Package

SYMBOL	INCHES		NOTE	MILLIMETERS	
	MIN.	MAX.		MIN.	MAX.
A	0.155	0.200		3.94	5.08
A <sub>1</sub>	0.020	0.050		0.508	1.27
B	0.014	0.020		0.356	0.508
B <sub>1</sub>	0.035	0.065		0.89	1.65
C	0.008	0.012	1	0.204	0.304
D	0.845	0.885		21.47	22.47
E <sub>1</sub>	0.240	0.260		6.10	6.60
e <sub>1</sub>	0.100 TP		2	2.54 TP	
e <sub>A</sub>	0.300 TP		2, 3	7.62 TP	
L	0.125	0.150		3.18	3.81
a	0°	15°	4	0°	15°
N	18		5	18	
N <sub>1</sub>	0		6	0	
S	0.015	0.060		0.39	1.52

92CS-30630

### (E) SUFFIX 22-Lead Dual-In-Line Plastic Package

SYMBOL	INCHES		NOTE	MILLIMETERS	
	MIN.	MAX.		MIN.	MAX.
A	0.155	0.200		3.94	5.08
A <sub>1</sub>	0.020	0.050		0.508	1.27
B	0.015	0.020		0.381	0.508
B <sub>1</sub>	0.035	0.065		0.89	1.65
C	0.008	0.012	1	0.204	0.304
D		1.120			28.44
E	0.390	0.420		9.91	10.66
E <sub>1</sub>	0.345	0.355		8.77	9.01
e <sub>1</sub>	0.100 TP		2	2.54 TP	
e <sub>A</sub>	0.400 TP		2, 3	10.16 TP	
L	0.125	0.150		3.18	3.81
L <sub>2</sub>	0	0.030		0	0.762
a	2°	15°	4	2°	15°
N	22		5	22	
N <sub>1</sub>	0		6	0	
Q <sub>1</sub>	0.055	0.085		1.40	2.15
S	0.015	0.060		0.381	1.27

92CS-30830

### (F) SUFFIX (JEDEC MO-001-AG) 16-Lead Dual-In-Line Frit-Seal Ceramic Package

SYMBOL	INCHES		NOTE	MILLIMETERS	
	MIN.	MAX.		MIN.	MAX.
A	0.165	0.210		4.20	5.33
A <sub>1</sub>	0.015	0.045		0.381	1.14
B	0.015	0.020		0.381	0.508
B <sub>1</sub>	0.045	0.070		1.15	1.77
C	0.009	0.011	1	0.229	0.279
D	0.750	0.795		19.05	20.19
E	0.295	0.325		7.50	8.25
E <sub>1</sub>	0.245	0.300		6.23	7.62
e <sub>1</sub>	0.100 TP		2	2.54 TP	
e <sub>A</sub>	0.300 TP		2, 3	7.62 TP	
L	0.120	0.160		3.05	4.06
L <sub>2</sub>	0.000	0.030		0.000	0.76
a	2°	15°	4	2°	15°
N	16		5	16	
N <sub>1</sub>	0		6	0	
Q <sub>1</sub>	0.050	0.080		1.27	2.03
S	0.010	0.060		0.254	1.52

92CM-22284R1

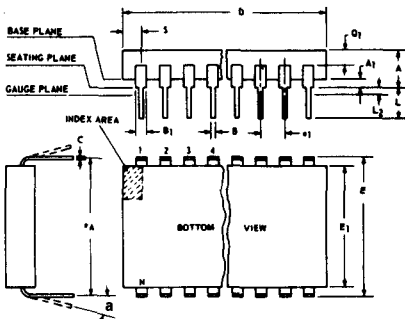

NOTES:  
Refer to Rules for Dimensioning (JEDEC Publication No. 95) for Axial Lead Product Outlines.

- When this device is supplied solder-dipped, the maximum lead thickness (narrow portion) will not exceed 0.013".
- Leads within 0.005" (0.12 mm) radius of True Position (TP) at gauge plane with maximum material condition and unit installed.
- e<sub>A</sub> applies in zone L<sub>2</sub> when unit installed.
- a applies to spread leads prior to installation.
- N is the maximum quantity of lead positions.
- N<sub>1</sub> is the quantity of allowable missing leads.

### (E) and (F) SUFFIXES (JEDEC MO-015-AA) 24-Lead Dual-In-Line Plastic or Frit-Seal Ceramic Package

SYMBOL	INCHES		NOTE	MILLIMETERS	
	MIN.	MAX.		MIN.	MAX.
A	0.120	0.250		3.10	6.30
A <sub>1</sub>	0.020	0.070		0.51	1.77
B	0.016	0.020		0.407	0.508
B <sub>1</sub>	0.028	0.070		0.72	1.77
C	0.008	0.012	1	0.204	0.304
D	1.20	1.29		30.48	32.76
E	0.600	0.625		15.24	15.87
E <sub>1</sub>	0.515	0.580		13.09	14.73
e <sub>1</sub>	0.100 TP		2	2.54 TP	
e <sub>A</sub>	0.600 TP		2, 3	15.24 TP	
L	0.100	0.200		2.54	5.00
L <sub>2</sub>	0.000	0.030		0.00	0.76
a	0°	15°	4	0°	15°
N	24		5	24	
N <sub>1</sub>	0		6	0	
Q <sub>1</sub>	0.040	0.075		1.02	1.90
S	0.040	0.100		1.02	2.54

92CS26938R2

### (E) SUFFIX 40-Lead Dual-In-Line Plastic Package

SYMBOL	INCHES		NOTE	MILLIMETERS	
	MIN.	MAX.		MIN.	MAX.
A	0.120	0.250		3.10	6.30
A <sub>1</sub>	0.020	0.070		0.51	1.77
B	0.016	0.020		0.407	0.508
B <sub>1</sub>	0.028	0.070		0.72	1.77
C	0.008	0.012	1	0.204	0.304
D	2.000	2.090		50.80	53.09
E <sub>1</sub>	0.515	0.580		13.09	14.73
e <sub>1</sub>	0.100 TP		2	2.54 TP	
e <sub>A</sub>	0.600 TP		2, 3	15.24 TP	
L	0.100	0.200		2.54	5.00
L <sub>2</sub>	0.000	0.030		0.00	0.76
a	0°	15°	4	0°	15°
N	40		5	40	
N <sub>1</sub>	0		6	0	
Q <sub>1</sub>	0.065	0.095		1.66	2.41
S	0.040	0.100		1.02	2.54

92CS-30959

# Dimensional Outlines (Cont'd)

## Ceramic Flat Packs

### (K) SUFFIX (JEDEC MO-004-AF) 14-Lead

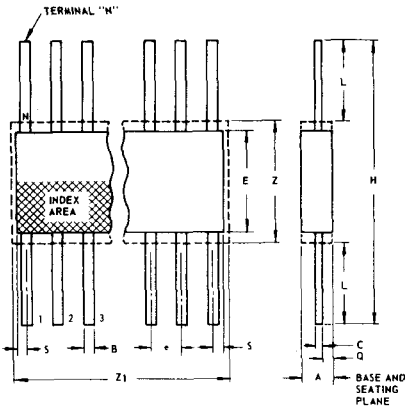

SYMBOL	INCHES		NOTE	MILLIMETERS	
	MIN.	MAX.		MIN.	MAX.
A	0.008	0.100		0.21	2.54
B	0.015	0.019	1	0.381	0.482
C	0.003	0.006	1	0.077	0.152
e	0.050 TP		2	1.27 TP	
E	0.200	0.300		5.1	7.6
H	0.600	1.000		15.3	25.4
L	0.150	0.350		3.9	8.8
N	14		3	14	
Q	0.005	0.050		0.13	1.27
S	0.000	0.050		0.00	1.27
Z	0.300		4	7.62	
Z <sub>1</sub>	0.400		4	10.16	

NOTES:

1. Refer to JEDEC Publication No. 95 for Rules for Dimensioning Peripheral Lead Outlines.
2. Leads within 0.005" (0.12 mm) radius of True Position (TP) at maximum material condition.
3. N is the maximum quantity of lead positions.
4. Z and Z<sub>1</sub> determine a zone within which all body and lead irregularities lie.

92SS-4300R3

### (K) SUFFIX (JEDEC MO-004-AG) 16-Lead

SYMBOL	INCHES		NOTE	MILLIMETERS	
	MIN.	MAX.		MIN.	MAX.
A	0.008	0.100		0.21	2.54
B	0.015	0.019	1	0.381	0.482
C	0.003	0.006	1	0.077	0.152
e	0.050 TP		2	1.27 TP	
E	0.200	0.300		5.1	7.6
H	0.600	1.000		15.3	25.4
L	0.150	0.350		3.9	8.8
N	16		3	16	
Q	0.005	0.050		0.13	1.27
S	0.000	0.025		0.00	0.63
Z	0.300		4	7.62	
Z <sub>1</sub>	0.400		4	10.16	

92CS-17271R3

### (K) SUFFIX 24-Lead

SYMBOL	INCHES		NOTE	MILLIMETERS	
	MIN.	MAX.		MIN.	MAX.
A	0.075	0.120		1.91	3.04
B	0.018	0.022	1	0.458	0.558
C	0.004	0.007	1	0.102	0.177
e	0.050 TP		2	1.27 TP	
E	0.600	0.700		15.24	17.78
H	1.150	1.350		29.21	34.29
L	0.225	0.325		5.72	8.25
N	24		3	24	
Q	0.035	0.070		0.89	1.77
S	0.060	0.110	1	1.53	2.79
Z	0.700		4	17.78	
Z <sub>1</sub>	0.750		4	19.05	

92CS-19949R2

### (K) SUFFIX 28-Lead

SYMBOL	INCHES		NOTE	MILLIMETERS	
	MIN.	MAX.		MIN.	MAX.
A	0.075	0.120		1.91	3.04
B	0.018	0.022	1	0.458	0.558
C	0.004	0.007	1	0.102	0.177
e	0.050 TP		2	1.27 TP	
E	0.600	0.700		15.24	17.78
H	1.150	1.350		29.21	34.29
L	0.225	0.325		5.72	8.25
N	28		3	28	
Q	0.035	0.070		0.89	1.77
S	0	0.060	1	0	1.53
Z	0.700		4	17.78	
Z <sub>1</sub>	0.750		4	19.05	

92CS-20972

---

---

# Application Notes

# Timekeeping Advances Through COS/MOS Technology

by S.S. Eaton

Most COS/MOS timing circuits consist of three basic parts: an oscillator, or main timing standard; some digital processing logic, usually in the form of frequency-dividing circuits; and logic-circuit drivers for mechanical or electrical output devices controlled by the digital processing logic. The oscillator is perhaps the most important because the accuracy of the total COS/MOS timing system is entirely dependent upon the accuracy of the oscillator. This Note discusses basic oscillator design considerations, practical COS/MOS oscillator circuits, and some typical COS/MOS timing-circuit applications.

### BASIC OSCILLATOR DESIGN CONSIDERATIONS

A basic oscillator circuit consists of an amplifier and a feedback section, as shown in Fig. 1. For oscillation to occur, the gain of the amplifier times the attenuation of the feedback network must be greater than one. In addition, the total phase shift through the amplifier and feedback network must be equal to  $n$  times 360 degrees, where  $n$  is an integer. These conditions imply that oscillations occur in any system in which an amplified signal is returned in phase to the amplifier input after being attenuated less than it was originally amplified. In such a system, any noise present at

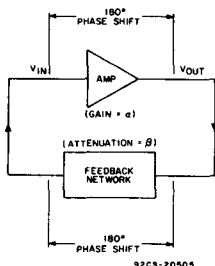

Fig. 1—Basic oscillator circuit.

the amplifier input causes oscillation to build up at a rate determined by the loop gain, or  $\alpha\beta$  product, of the over-all circuit.

The frequency stability of an oscillator is primarily dependent upon the phase-changing properties of the feedback network. For high stability, quartz crystals and tuning forks are commonly used as feedback network elements. The quartz crystal is the more popular because of its higher Q or greater inherent frequency stability.

### Selection of Crystal Operating Mode

Fig. 2 shows the equivalent circuit of a quartz crystal, and Table I lists typical component values of the elements included in the equivalent circuit for different crystal cuts and operating frequencies. The basic circuit can be resolved into equivalent resistive ( $R_s$ ) and reactive ( $X_s$ ) components. Fig. 3 shows curves of these components as functions of frequency for a typical 32.768-kHz crystal. Fig. 3(b) shows two points at which the crystal appears purely resistive, (i.e., points at which  $X_s = 0$ ). These points are defined as the resonant ( $f_r$ ) and antiresonant ( $f_a$ ) frequencies. Series-resonant oscillator circuits are designed to oscillate at or near  $f_r$ . Parallel-resonant circuits oscillate between  $f_r$  and  $f_a$ , depending upon the value of a parallel loading capacitor, as discussed later. In contrast to series-resonant circuits, parallel resonant-circuits work best with amplifiers that have high input impedances. The parallel-resonant circuit, therefore, is most applicable to crystal oscillators that employ COS/MOS amplifiers.<sup>1</sup>

### Feedback-Circuit Configuration

A feedback circuit suitable for use with a parallel-resonant oscillator circuit is shown in Fig. 4. This circuit, known as a crystal pi network, is intended for use after an amplifier that provides a 180-degree phase shift. The pi network is designed to provide the additional 180-degree phase shift required for oscillation. The phase angle for this type of feedback circuit is extremely sensitive to a change in frequency, a condition necessary for stable oscillation. If the equivalent resistance of the crystal were in fact zero (infinite

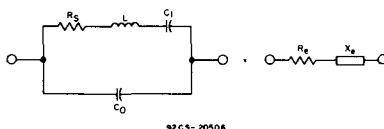

Fig. 2—Equivalent circuit for a quartz crystal.

Table I—Typical Component Values for Common Cuts of Quartz Oscillator Crystals

FREQUENCY	32 kHz	280 kHz	525 kHz	2MHz
Cut	XY Bar	DT	DT	AT
$R_s$ (ohms)	40K	1820	1400	82
$L$ (Hy)	4800	25.9	12.7	0.52
$C_1$ (pF)	0.00491	0.0125	0.00724	0.0122
$C_0$ (pF)	2.85	5.62	3.44	4.27
$C_0/C_1$	580	450	475	350
Q	25000	25000	30000	80000

Q), a change in the phase angle of the feedback circuit would not cause any change in oscillator frequency; the frequency, therefore, would be insensitive to any phase change in the amplifier. Though practical crystals allow only a slight change in frequency for large variations in phase angle, the amplifier phase angle should, to the extent possible, be made independent of temperature and supply-voltage variations in order to minimize the phase compensation required of the feedback network. Any required phase compensation will, of course, dictate a corresponding change in the frequency of oscillation consistent with practical values of crystal Q. For this reason, the equivalent resistance of the crystal should be maintained as low as possible, and the amplifier should be designed to roll off at frequencies greater than the crystal frequency.

### Oscillator Amplifier

Fig. 5 shows a COS/MOS amplifier circuit that may be used to provide the amplification function in a crystal-controlled oscillator. The amplifier is biased so that the output voltage  $V_{OUT}$  is equal to the input voltage  $V_{IN}$  or typically is equal to one-half the supply voltage  $V_{DD}$ , (i.e.,  $V_{OUT} = V_{IN} = V_{DD}/2$ ). Biasing is accomplished by means of a resistor that has a value high enough to prevent loading of the feedback network, yet that is low in comparison to the amplifier input resistance. Resistor values of 10 to 500 megohms will satisfy these criteria; however, lower values in the order of 15 megohms are generally used to allow greater input leakage without any severe change in bias point. The gain of the amplifier varies with supply voltage, the size of the n- and p-channel MOS transistors, and the sum of the threshold voltages of the n- and p-channel transistors. When an oscillator amplifier is designed to roll off at frequencies greater than the crystal frequency, care must be taken to

assure that the transistor sizes are large enough for the particular supply voltage used and range of threshold voltages expected. For any circuit, though, the sum of the threshold voltages of the n- and p-channel transistors must always be less than the supply voltage.

The oscillator amplifier governs, to a certain extent, the selection of the components for the feedback network. The amplifier current consumption is strongly dependent upon the attenuation across the feedback network. As the attenuation becomes greater, the signal at the amplifier input becomes smaller, which, in turn, increases the amplifier current consumption. Large voltage swings at the amplifier input cause little current to flow because the resistance of either the n- or p-channel transistor is high during a large portion of the cycle. On the basis of power considerations, it is best to design the feedback network for a small attenuation.

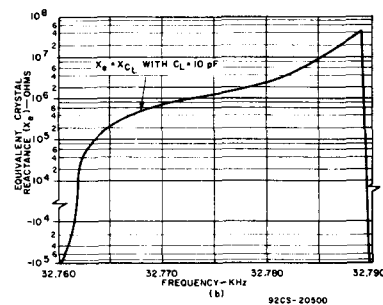
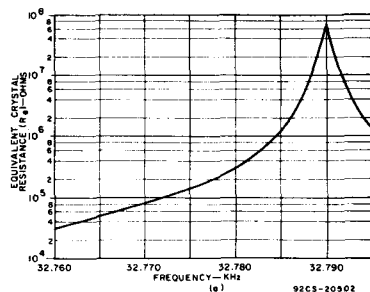

Fig. 3—Impedance characteristics of a quartz oscillator crystal: (a) equivalent crystal resistance as a function of frequency; (b) equivalent crystal reactance as a function of frequency.

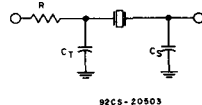

Fig. 4—Crystal pi-type feedback network.

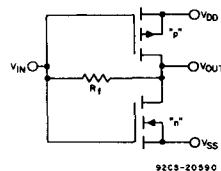

Fig. 5—COS/MOS amplifier.

**Equivalent Crystal Resistance**

The equivalent resistance  $R_s$  of the crystal should be maintained as small as possible in order to obtain minimum attenuation across the feedback network. For any given circuit, the oscillator current always increases with a rise in crystal resistance. This factor and stability considerations provide strong arguments for the purchase of crystals that have low series resistance, although the usual cost tradeoffs prevail.

**Crystal Load Capacitance**

Another factor that influences the over-all power consumption is the size of the pi-network capacitor at the amplifier output. For minimum current consumption, this capacitor, obviously, should be kept small. This condition, however, does not always imply high frequency stability. The choice of the capacitor value first involves a determination of the over-all crystal load capacitance. The phase angle of the feedback network approaches 180 degrees when the crystal equivalent reactive component  $X_c$  is equal to the reactance ( $X_{CL}$ ) of a capacitor placed in parallel with the crystal. Fig. 4 shows that the effective capacitance across the crystal consists of the two pi-network capacitors in series. If the value of the equivalent reactance  $X_c$  at the crystal frequency, as may be determined from Fig. 3(b), is equal to the value of the crystal load capacitance  $C_L$ , then the equivalent value of the two series-connected pi-network capacitors can be calculated from the following relationship:

$$C_L = 1/\omega X_c \quad (1)$$

The value of the load capacitance  $C_L$ , in general, is chosen first, and the crystal manufacturer is required to cut the crystal to oscillate at the desired frequency for the specified value of load capacitance.

The choice of a load capacitance is important in terms of over-all power consumption and frequency stability. Higher values of  $C_L$  generally improve frequency stability, but also increase power dissipation. The timing industry presently seems to have standardized on values of  $C_L$  between 10 and 20 picofarads.

The choice of the total equivalent load capacitance  $C_L$  only fixes the series sum of the two pi-network capacitors. The individual capacitors themselves can be found from the following equations:

$$C_T = 4C_L / (1 - 5fR_c C_L) \quad (2)$$

$$C_S = 4C_L / (3 + 5fR_c C_L) \quad (3)$$

The actual value of  $C_S$  used in the feedback circuit should be about 3 picofarads less than the calculated value to allow for the amplifier input capacitance. The value of the amplifier output capacitor  $C_T$  should not normally be fixed. A trimmer capacitor should be placed in parallel with, or used in place of, a fixed output capacitor to allow for variations in stray capacitance and circuit components. The mid-range value of the output capacitor combination should be equal to the calculated value of  $C_T$ .

**Frequency-Trimming Capability**

The required capacitance range for the oscillator trimmer capacitor is determined by the variation in oscillation frequency with a change in load capacitance.<sup>2</sup> The total frequency-trimming range of a crystal-controlled oscillator circuit is mainly a function of the crystal characteristics, or more explicitly, is inversely proportional to the slope of the crystal reactance curve, shown in Fig. 3(b). The slope of this curve is a function of the difference between the resonant frequency  $f_r$  and the antiresonant frequency  $f_a$ . This frequency difference, in turn, is a function of the crystal capacitance ratio  $C_0/C_1$ , where  $C_0$  and  $C_1$  are the inherent shunt and series capacitances, respectively, of the crystal structure, as shown in Fig. 2. The slope of the reactance curve is also a function of the total external crystal load capacitance  $C_L$ . As shown in Fig. 3(b), this slope decreases as the equivalent reactance increases, (i.e., for smaller values of the capacitance  $C_L$ ). Fig. 6 and Table II show trimming-range data for a typical 32.768-kHz crystal that has a capacitance ratio  $C_0/C_1$  of 530. These data show that smaller values of load capacitance result in greater trimming-range capability.

**Temperature Stability**

Another important oscillator consideration is temperature stability. Most crystals have a negative parabolic temperature coefficient.<sup>2</sup> Fig. 7 shows a typical curve of the variation in crystal frequency as a function of temperature. The frequency of the total oscillator circuit also exhibits a similar temperature dependence. Temperature compensation of the over-all oscillator circuit can be achieved by use of a capacitor that has a positive parabolic temperature coefficient in the pi feedback network.<sup>3</sup> For comparison, Fig. 7 also shows a typical resultant curve for the over-all circuit.

The temperature characteristics of a crystal are determined to a large extent by the crystal cut. Popular low-frequency cuts include the NT and XY Bar. The XY Bar is the more popular of the two types because it can be made smaller for a given Q and is easier to trim. The disadvantage of a slightly lower shock resistance of XY Bar crystals is compensated by the superior aging characteristics of this type.

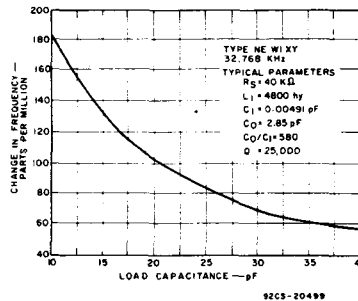

Fig. 6— Frequency as a function of load capacitance for a typical 32-kHz crystal.

AT-cut crystals, when used at frequencies greater than 1 MHz, are characterized by excellent temperature stability and ruggedness. Temperature characteristics for this type of crystal cut as well as for the XY Bar and NT types are shown in Fig. 8.

**Crystal Dimensions**

Size is also an important consideration in the design of oscillator crystals. The length of quartz required for any given cut is inversely proportional to the square root of frequency. Dimensions for a typical packaged 32-kHz, XY Bar crystal are 0.6 inch by 0.2 inch by 0.11 inch. The smallest XY Bar crystals currently available have dimensions in the order of 0.53 inch by 0.2 inch by 0.11 inch. A 1-MHz AT-cut crystal is significantly larger; however, dimensions again decrease with frequency. Crystal manufacturers are currently working to develop wristwatch-size AT-cut crystals with the anticipation of circuit improvements that will allow low-current operation at high frequencies.

**Crystal Shock Resistance and Aging Rate**

A prime concern of the timing industry today is that of crystal shock resistance and aging. The aging of a crystal results primarily from aging of the mounting material rather

Table II — Trimming Data for a Typical 32-kHz Quartz Oscillator Crystal

TRIM	LOAD CAPACITANCE, $C_L$			
	5 pF	11.5 pF	20 pF	32 pF
$\pm 20$ PPM	-0.45 +0.51 pf	-1.6 +2.0 pf	-3.7 +5.5 pf	-8.0 +14.7 pf
$\pm 25$ PPM	-0.56 +0.65 pf	-1.9 +2.6 pf	-4.5 +7.3 pf	-9.4 +20.5 pf
$\pm 30$ PPM	-0.66 +0.79 pf	-2.3 +3.3 pf	-5.2 +9.3 pf	-10.7 +27.9 pf

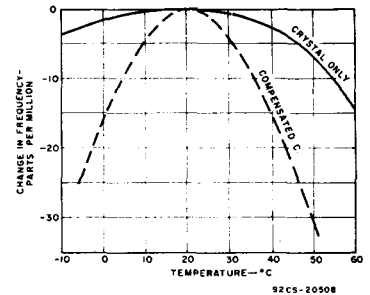

Fig. 7— Effect of temperature on crystal frequency.

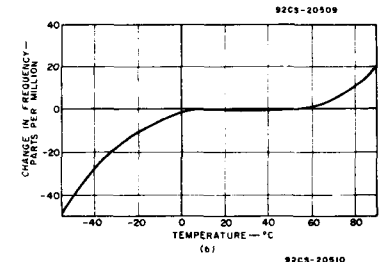
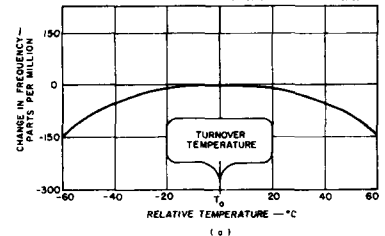

Fig. 8— Frequency-temperature characteristics for various crystal cuts: (a) XY-Bar and NT cuts; (b) AT cut.

than from aging of the quartz itself. The mounting material enters into the crystal equivalent circuit, and the slowest aging rate results when the mount consists of the least amount of supporting material. This condition of course, results in lower shock resistance, and an optimum trade-off must be achieved. At present, 32-kHz crystals can be made that can withstand a mechanical shock of about 1500 G's applied for 0.5 millisecond and that have aging rates that result in a frequency change of 2 to 5 parts per million for the first year and essentially no aging thereafter. Any mechanical or thermal shock, however, will interrupt the normal aging process. The aging rate of 2 to 5 parts per million presently appears acceptable to the timing industry, although shock resistances of 3,000 to 5,000 G's are desired. This shock level corresponds approximately to the shock experienced by dropping the crystal from a height of one meter onto a hardwood floor.

**PRACTICAL OSCILLATOR CIRCUITS**

The basic amplifier, feedback-network, and crystal considerations discussed in the preceding paragraphs can be combined in the design of COS/MOS oscillator circuits. In the circuits, the crystal selected has an equivalent resistance  $R_c$  of 50 kilohms and is cut to operate at a frequency of 32.768 kHz with a load capacitance  $C_L$  of 10 picofarads. The values of pi feedback-network capacitors  $C_T$  and  $C_S$  can be calculated by use of Eqs. (2) and (3) as  $C_T = 43$  picofarads and  $C_S = 13$  picofarads. The value of the feedback-network resistance  $R$  can be calculated as follows:

$$R = \frac{(3X_c + 0.27 R_c)(X_c - 0.8 R_c)}{16 R_c} \approx 1 M\Omega$$

# ICAN-6086

This value is the maximum value of resistance allowed for a minimum feedback-network attenuation of 0.75, a value chosen on the basis of power and stability considerations.<sup>1</sup> The calculated value of R includes any fixed resistance plus the amplifier output resistance. Because the output resistance is often appreciable and varies with supply voltage, transistor size, and threshold voltages, it is generally best to add resistance experimentally until the desired power consumption and frequency stability are reached. The effect of this resistance on operating current and frequency stability can be predicted from data given in Table III for the three different COS/MOS crystal oscillator circuits shown in Fig. 9.

In each circuit, the pi-network capacitors  $C_T$  and  $C_S$  are 39 picofarads and 10 picofarads, respectively. These capacitances are slightly less than the calculated values because of stray and amplifier capacitances.

The circuit shown in Fig. 9(a) combines the amplifier and feedback circuits shown in Fig. 4 and 5. Although theory predicts that an increase in the values of the feedback-network resistor R will result in increased frequency stability, the circuit performance data given in Table III show no significant improvement in this characteristic. This result indicates that the circuit instability can be attributed almost entirely to phase instabilities of the amplifier. This assumption is verified by data taken from the circuits shown in Figs. 9(b) and 9(c) in which the required feedback-network resistance is incorporated into the amplifier as a fixed value. The resistors essentially fix the amplifier phase shift so that greater stability results. As the data show, use of these resistors also results in a decrease in the total current consumption. Because of the two fixed resistors, the circuit of Fig. 9(b) shows the least current consumption and also the greatest stability.

Table III - Typical Oscillator Data

Circuit	Value of R ( $\Omega$ )	VDD (Volts)	Current ( $\mu$ A)	Frequency Stability VDD = 1.45V to 1.6V
9(a)	0	1.60	4.0	2.8
"	0	1.45	3.1	
"	100K	1.60	3.1	
"	"	1.45	2.4	
"	200K	1.60	2.9	
"	"	1.45	2.1	2.6
9(b)	100K	1.60	2.3	
"	"	1.45	2.0	.3
"	"	1.1	1.5	
"	150K	1.60	1.8	
"	"	1.45	1.6	
"	"	1.1	.95	
9(c)	200K	1.60	5.0	.6
"	"	1.45	4.4	
"	300K	1.60	3.5	
"	"	1.45	3.0	.5

As mentioned previously, the amplifier feedback resistor should not significantly load the crystal feedback network. The resistor value at which loading begins to occur can be determined from a curve of circuit operating frequency as a function of feedback resistance. Fig. 10 shows such a curve for the circuit shown in Fig. 9(b). This curve indicates that 15 megohms is a suitable value for the feedback resistor.

## FREQUENCY DIVIDERS

Because of restrictions on crystal size and cost, oscillator frequencies of 8192 Hz, or higher, are generally used for electronic timing circuits. The use of such high crystal frequencies usually requires division of the oscillator frequency to a more convenient value. Synchronous motors, for example, are often driven by frequencies between 0.5 Hz and 64 Hz. Numeric readouts for digital clocks or wristwatches

require pulses at least every second, minute, and hour. The necessity for frequency division becomes clear if one considers the wide variety of timing intervals that may be required for certain applications.

The basic frequency-dividing circuit, shown in Fig. 11, consists of a master-slave D-type flip-flop connected as a binary counter stage. N stages may be cascaded with the final output frequency equal to  $2^{-N}$  times the input frequency. Division by integers other than powers of 2 can also be accomplished by use of gating techniques. For example, a divide-by-60 counter implemented as shown in Fig. 12, can be used to obtain minutes from seconds.

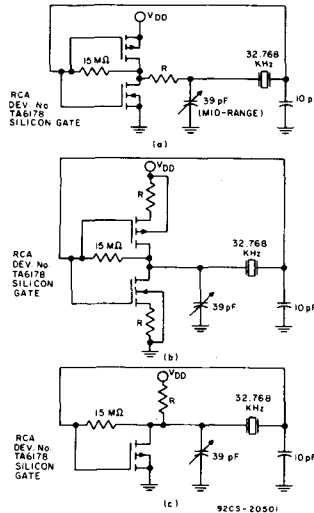

Fig. 9— Typical COS/MOS crystal-oscillator circuits.

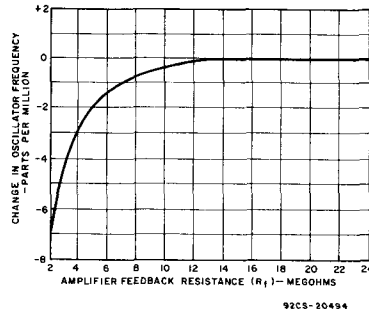

Fig. 10— Oscillator frequency as a function of amplifier feedback resistance.

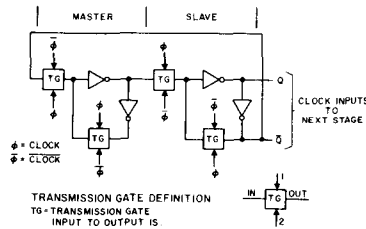

Fig. 11— Basic frequency-dividing stage.

A basic block diagram of a typical digital clock that employs divide-by-60 counters is shown in Fig. 13. The display for the clock is designed to be multiplexed in that new information is provided to only one of the six readout characters, while the eye itself holds the previous state of the other five. The multiplexing unit consists of COS/MOS transmission gates controlled by a six-stage ring counter that also addresses each character sequentially. This type of circuit is particularly applicable for driving light-emitting diode displays.

Light-emitting diodes, as well as other readout devices, require some form of driving circuitry which is often unique to the driven device. Other typical readout devices include stepping motors, balance-wheel motors, tuning-fork motors, and liquid-crystal displays.

Motors are frequently driven by low-impedance MOS transistor drivers. The waveforms required depend upon the particular type of motor. Rotary stepping motors require a pulsed waveform such as that shown in Fig. 14(a). The motor advances one position (for example 180 degrees) on each pulse. Fig. 14(b) shows a COS/MOS circuit that may be used to generate this type of waveform. The crystal frequency and the number of countdown stages for this circuit determine the pulse frequency. The duty factor is controlled by two resettable flip-flops that are clocked inversely by the last counting stage and reset by an intermediate stage. The output waveform from this circuit will have a duty factor that is exactly given by  $2^{1-N} - 1$  where 1 is the number of the intermediate stage used to reset the shaping flip-flops and N is the total number of frequency-divider stages.

A tuning-fork motor consists of two coils wired in series and wound on either side of the fork. A subdivision of the crystal frequency drives the coils which electromagnetically vibrate the fork. The fork can be linked to an index wheel that, in turn, can drive the hands of a watch.

A balance-wheel motor consists of a coil fixed near the periphery of a pivoted balance wheel. Permanent magnets are attached to one side of the wheel and counterweights to the other. The coil can be energized by pulses supplied to the gate of an n-channel MOS transistor with the coil connected between the drain and the supply voltage of the transistor. When the coil is energized, the balance wheel swings toward the coil. The momentum of the wheel moves it beyond the coil, and spring action then forces it back. Repeated cycles generate a back-and-forth motion which can be linked to a wheel for driving the hands of a watch or clock.

Seven-segment liquid-crystal numerals can be driven as shown in Fig. 15. An ac voltage is required across each segment of the display to assure long life. For this purpose, a 60-Hz square wave is applied to one input of each of seven exclusive-OR gates. The logic state present at the other input determines whether the segment will transmit or scatter light.

Liquid-crystal displays can be made for operation in either transmissive or reflective modes. The transmissive-mode type requires a light source behind the display. The light will either be transmitted or not depending upon the voltage across the segment. In the reflective-mode type, ambient light can be scattered by the liquid crystal material, or reflected from a mirrored surface placed behind the numeral. If displayed correctly, excellent contrast between "on" and "off" segments can be obtained when reflecting or scattering only ambient light.

The light scattering property of liquid-crystal displays offers two major advantages. First, the problem of washout in high intensity light is prevented. Washout has always been a problem with light generating displays. Second, because the displays do not generate light, they require negligible power. In fact, liquid crystals require the least amount of power of any currently available type of display.<sup>4</sup>

Light-emitting diodes are somewhat simpler to drive than liquid crystals because signals to individual segment and/or numerals can be easily multiplexed. Fig. 16 shows a typical multiplexed driving circuit. The n-p-n transistor, which is common to the cathode of all segments in each numeral, can be turned on to address only one particular numeral. The eye will hold the reading from all off segments long enough for at least six numerals to be multiplexed.



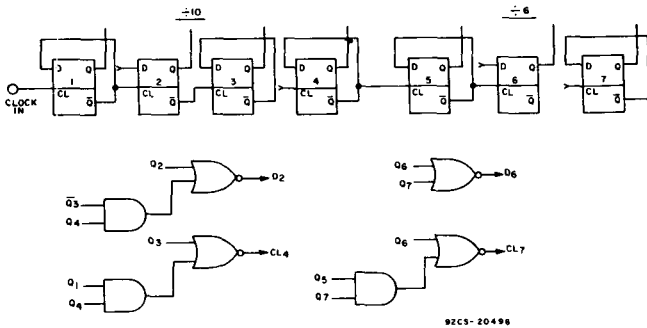

Fig. 12- COS/MOS divide-by-60 counter.

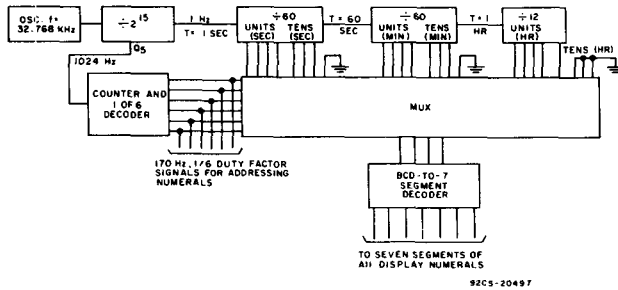

Fig. 13- Typical COS/MOS digital clock.

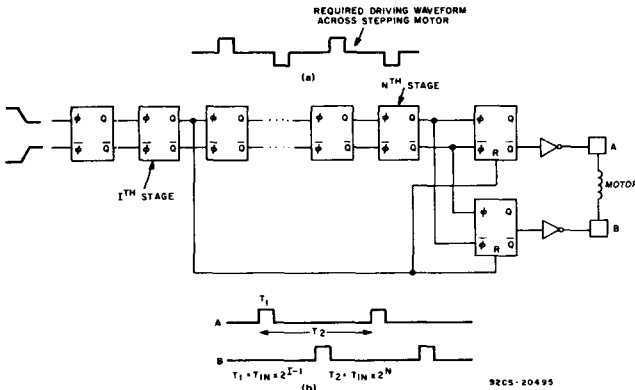

Fig. 14- Generation of required stepping-motor waveforms: (a) required driving waveform across stepping motor; (b) COS/MOS driving circuit and output waveforms applied to motor control winding.

**COS/MOS TIMING-CIRCUIT APPLICATIONS**

The choice of a readout device depends, of course, upon the application involved and to a certain extent upon the individual characteristics of the device itself. Special considerations for readout devices are perhaps best treated in a discussion of special requirements for three important timing-circuit applications, namely, wristwatches, wall clocks, and automobile clocks.

**Wristwatches**

In any wristwatch application, size and total operating current are perhaps the two most important considerations. The total timing circuitry, together with the battery and readout device, must fit into a relatively fixed size and have a current consumption small enough to allow at least one year of life. Size and power considerations also become important in crystal selection. The size and cost of a crystal decreases with increases in frequency up to about 1 MHz. The power consumption of the oscillator and counter increases with frequency. On the basis of these considerations, the most popular crystal frequency for wristwatches at present is 32.768 kHz. Typical packaged sizes for this crystal and various available crystal oscillator circuits were discussed in an earlier section of this Note.

The choice of a readout device also involves considerations of size and power as well as, of course, marketing considerations. If conventional-hand movements are chosen, a motor type of drive must be selected. No great size advantage exists over any of the various motor types used in this type of application. In addition, all types can be designed to operate from 1.1 to 1.6 volts with average current consumptions of about 10 microamperes. Sensitivity to vibration, however, is one separating characteristic. Although balance-wheel motors can be designed to compensate to a certain extent for speed variations produced by vibrations, the stepping motor, which is insensitive to vibration, remains superior in this respect. At present, however, the stepping motor is the more expensive of the two types.

Light-emitting diodes require a minimum of two battery cells for proper operation. The required current can be kept to about 2 milliamperes per segment when the diodes are pulsed from a six-stage ring counter, as shown in Fig. 13. A duty factor of 16 per cent is achieved with this arrangement. Because of the high current, however, a continuously operating battery-powered display is not possible, and a "readout on demand" watch is then necessary.

Continuously operating liquid-crystal displays are possible and practical. RCA wristwatch displays employ liquid-crystal material having resistivities of about  $5 \times 10^9$  ohms per centimeter, which at a 0.5-mil spacing results in a resistance of 6.3 megohms per square centimeter. With all segments energized, the display consumes only about 1 microampere of current at 15 volts. Liquid crystals, however, require a minimum supply of 12 volts to assure good contrast between on and off segments. For single-cell operation, a dc-to-dc converter must be used to step the voltage up to the required 12-to-15-volt level. Transformer and capacitor voltage-doubling circuits with conversion efficiencies of about 75 per cent are typically used for this purpose.

Because current consumption is such an important consideration for wristwatch circuits, the careful consideration given to the choice of a battery is easily understood. Small silver-oxide and mercury cells are presently popular for wristwatch use. Pertinent information on these types of

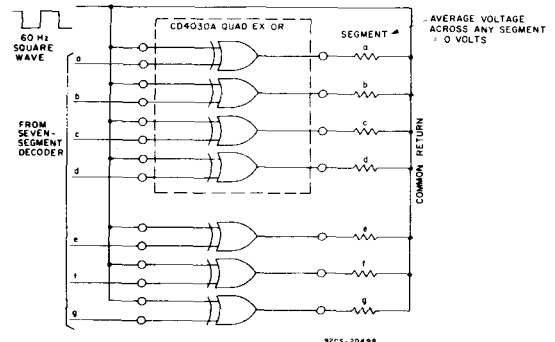

Fig. 15- COS/MOS liquid-crystal driving circuit.

# ICAN-6086

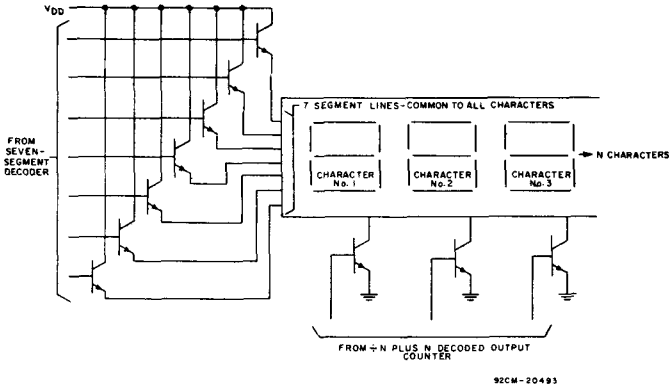

Fig. 16— Multiplexing driving circuit for light-emitting diodes.

Mallory cells is shown in Table IV. Most of the cells listed will last at least one year with a motor current of 10 microamperes and a total oscillator and divider current less than 5 microamperes at an oscillator frequency of 32.768 kHz. The voltage for both types of cells is relatively constant during the active life listed and falls off rapidly thereafter. Typical end-of-life voltages at 1.1 volts for mercury cells and 1.45 volts for silver-oxide cells. Either type of cell works equally well with RCA silicon-gate COS/MOS circuits which operate from supply voltages as low as 1.1 volts.

### Wall Clocks

Size and power limitations for clocks are not as restrictive as those for wristwatches. For this reason, lower-cost, higher-frequency crystals may be used. The optimum range of crystal frequencies presently appears to be from 131 kHz to 524 kHz. All the oscillator considerations given previously for operation at 32 kHz apply equally well to this higher frequency range. The oscillator circuit configuration shown in Fig. 9(b) is still the optimum type; however, the value of the source resistors must be decreased to assure adequate gain at the higher frequencies. Source resistors are often best chosen experimentally by gradually increasing the resistance until an output voltage swing of 30 to 70 per cent of the supply voltage  $V_{DD}$  is reached. Data taken from a typical 262-kHz oscillator circuit that employs two 10-kilohm source resistors and a DT-cut, 262-kHz crystal are shown in Table V. The table also shows typical counter current.

The most popular readout devices for clocks are conventional-hand movements and liquid-crystal displays. Continuously operating light-emitting-diode numerals consume too much current even for long life of C- and D-size batteries. In contrast, a typical RCA four-digit liquid-crystal

Table IV — Typical Data for Mallory Watch Cells

Type	Voltage	Capacity $\mu\text{A yrs.}$	Height (in.)	Diameter (in.)
WH3	1.35	25	0.208	0.455
WS 14 Type A	1.55	19	0.210	0.455
W4	1.35	11	0.139	0.455
WS11	1.55	11	0.164	0.455
10 R 101 (EXP)	1.35	36	0.190	0.610
10 L 19 (EXP)	1.55	27	0.190	0.610
WD4	1.36	14	0.149	0.594
WD5	1.36	23	0.110	1.003

display having a 0.4-inch-by-0.6-inch numeral consumes only 100 microamperes of current with all segments energized.

Motors for driving the clock hands are typically of the balance-wheel or continuously rotating synchronous types. Sensitivity to vibration is usually not a restriction; hence, the balance wheel motor can be successfully used in place of the more expensive stepping motor. Clock motors typically require about 300 to 450 microwatts of power, or average currents of 200 to 300 microamperes at 1.5 volts.

These currents, together with the oscillator and counter currents given in Table V, can now be compared with typical battery capacities. Battery information extrapolated from published Eveready data on popular AA-, C-, and D-size cells is listed in Table VI.<sup>5</sup> Most of the battery current is consumed by the motor, and if a total current of 250 microamperes is assumed, the data show a carbon-zinc C cell as the minimum size battery required for one year of life.

### Auto Clocks

Auto clock circuits are somewhat unique in that power considerations are not nearly as restrictive as in other portable applications. Although the low-power feature of COS/MOS circuits is helpful, the main advantages obtained

Table V — Typical Data for 262-kHz Oscillator and Counter Circuits

Product	$V_{DD}$ (Volts)	Oscillator Current ( $\mu\text{A}$ )	Counter Current ( $\mu\text{A}$ )	Freq. Stability (ppm)
Silicon-Gate	1.1V	7	7	2.0 ppm
"	1.3V	9.5	9	
"	1.5V	11.5	10	
"	1.6V	12.5	11	1.2
Low-Voltage	2.2V	21	10	1.8
"	3.0V	35	13	

from the use of COS/MOS in automobile clocks, or in any automotive application, are those of wide operating voltage and temperature range and high noise immunity.

With little restriction on power, the choice of a crystal depends mainly on cost. Crystals typically used for automobile timing applications are AT-cut types that operate at frequencies between 1 MHz and 4.2 MHz. The oscillator considerations discussed earlier also apply to these frequencies; however, as the frequency increases, it becomes increasingly difficult to maintain a low starting voltage at a low current. At high frequencies, the starting voltage and current are inversely proportional and are controlled mainly by the values of the capacitors on the pi-type feedback network and the size of the COS/MOS amplifier transistors.

Table VI — Life Data for Typical Batteries

Eveready Type #	Mallory Type #	Size	Type	Life (Days)
915	M15F	AA	Carbon-Zinc	150
E91	MN1500	AA	Alkaline	200
935	M14F	C	Carbon-Zinc	385
E93	MN1400	C	Alkaline	575
950	M13F	D	Carbon-Zinc	800
E95	MN1300	D	Alkaline	1100

All life data assumes a continuous drain of 250  $\mu\text{A}$  and an end-of-life voltage of 1.1V.

For minimum starting voltage, relatively small capacitors should be used in the pi-feedback network, and no source resistors should be added to the amplifier. As indicated by data taken on the circuit shown in Fig. 9(b) and shown in Table VII, low power can still be maintained even when the source resistors are not used.

Table VII — Typical High-Frequency Data for COS/MOS Oscillator and Counter Circuits (Low-Voltage Counter)

$V_{DD}$ (Volts)	Freq. (MHz)	Oscillator Current (mA)	Counter Current (mA)	Motor Current (mA)
5	1	0.28	0.125	5V
12	1	1.3	0.275	2-5 mA
5	2	0.37	0.250	12V
12	2	1.5	0.550	5-10 mA
5	3	0.40	0.375	5V
12	3	1.9	0.825	3-8 mA
5	4	0.43	0.500	12V
12	4	2.3	1.1	8-20 mA

The upper limit of the crystal frequency depends not so much on power consumption as on the minimum supply voltage allowed for circuit operation. The minimum automobile battery voltage is generally considered to be 5 volts; however, the supply voltage for the timing circuit can be considerably less than this value depending upon the design of the transient protection circuit, as discussed later. Table VIII lists minimum COS/MOS supply voltages for typical oscillator circuits. The values shown permit design at two temperatures. The lower temperature is often considered adequate by auto companies with the opinion that the minimum battery voltage of 5 volts rarely, if ever, occurs at high temperatures.

The oscillator in a typical auto clock circuit is followed by a number of frequency-dividing stages, the last stage of which is frequently used to drive a motor. Long counter chains are required because of the high oscillator frequency; however, the power dissipation of COS/MOS circuits is so low that the number of stages is only restricted by chip size limitations. Because COS/MOS circuits consume current only during switching transitions, each counter stage averages one-half the current of the previous stage. The first counter stage, therefore, consumes as much current as all of the following stages combined for a counter of infinite length. Little difference, then, exists between the power consumption of a ten-stage or thirty-stage COS/MOS counter. Table VII lists, in addition to the oscillator current, typical values of counter current, as well as some typical ranges of peak and average motor currents.

Current data, such as that shown in Table VII, are necessary for a proper design of the transient protection circuit, an essential part of any automobile digital logic system. Automobile manufacturers disagree on the maximum amplitude and decay of transient voltage; however, values often used are maximum transients of +120 volts and -90 volts, each decaying exponentially with a maximum time constant of 45 milliseconds. Because standard COS/MOS circuits are rated for a maximum supply of 15 volts, a protection circuit must be included between the battery and the COS/MOS logic.

Table VIII - Minimum Operating Voltages for COS/MOS Integrated Circuits

Freq. (MHz)	Low-Voltage Product				Silicon-Gate Product			
	1	2	3	4	1	2	3	4
Min. Voltage at 25°C	2.9	3.1	3.5	4.0	1.6	2.0	2.6	3.0
Min. Voltage at 82°C 180°F	3.0	3.3	4.0	5.0	1.8	2.6	3.4	4.0

Fig. 17 shows a transient-voltage protection circuit that is frequently used. The zener diode regulates the voltage supply for the clock circuits, and the capacitor and series diode prevent timing losses during negative transients. For minimum zener current during transients, the maximum value of R should be based on the minimum circuit operating voltage and the peak current drawn by the logic circuit and motor at the minimum battery voltage. The minimum zener breakdown voltage is then determined by subtraction of the product of the minimum current drain at the normal battery voltage and the value of R just chosen from the battery voltage. A zener breakdown greater than this voltage assures that no unnecessary current will be drawn by the zener during normal automobile operation.

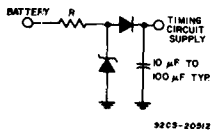

Fig. 17- Automobile transient-protection circuit.

Another important zener characteristic is dynamic impedance. During a current surge, the voltage across the zener must not rise to a damaging level. A value of 22 volts for the 45-millisecond time constant appears safe for standard COS/MOS circuits.

In the design of a typical transient-voltage protection circuit, it is assumed that the minimum battery voltage is 5 volts, that the minimum circuit operating voltage is 3.5 volts at a crystal frequency of 3.145728 MHz, and that a peak current of 3 milliamperes is obtained at 5 volts. The value of the resistance R is then found as  $(5 - 3.5 + 0.7)/3 \approx 250$  ohms. With a minimum current of 5 milliamperes at 12 volts, the minimum zener voltage becomes  $12 - 5(0.250) = 11.75$  volts. For a +120-volt transient, the zener could then consume a peak current of  $(120 - 11.8)/250 = 0.4$  ampere. For a maximum zener voltage of 13 volts, the dynamic impedance of the zener must be less than  $(22V - 13V)/.4A = 22$  ohms. Components chosen in this manner will provide adequate protection for anticipated transients.

Both protection-circuit diodes can be integrated onto the COS/MOS chip. When located as shown in Fig. 17, the series diode need only have a breakdown rating of about 12 volts. Zener diodes that have breakdown ratings of 4.5 to 6.0 volts or any multiple thereof can also be integrated onto the COS/MOS chip. The breakdown rating can also be increased in 0.7-volt steps by addition of forward-biased diodes in series. Characteristics of two typical zener diodes integrated in series are shown in Fig. 18. Fig. 18(a) shows the area around the "knee" of the breakdown region, and Fig. 18(b) shows the higher-current region useful for determining the dynamic resistance. From the slope of the line, the typical

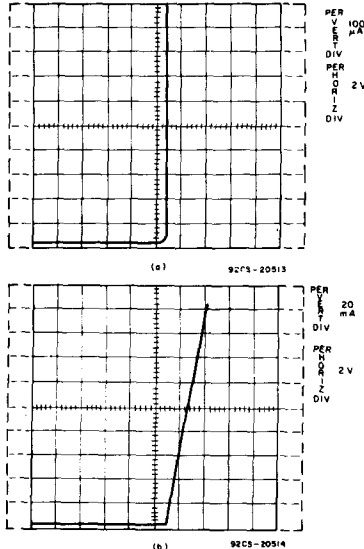

Fig. 18- Oscillograph tracings showing characteristics of an integrated zener diode: (a) low-current region; (b) high-current region.

dynamic resistance for two diodes is found to be 17.6 ohms total, or 8.8 ohms per diode. The diodes are rated to withstand a 0.5-ampere surge current that decays with an 80-millisecond time constant. The zener diode, then, is compatible with present automobile protection requirements, and integration of this component should represent a considerable cost saving, especially when integrated with the series diode.

Other Applications

Although wristwatches and clocks of various types are important applications of COS/MOS timing circuits, they are certainly not the only timing applications which can benefit from the unique features of COS/MOS logic. Applications such as fuse timers, feeding systems, automatic sprinklers, incubator timers, and other similar systems can be designed from information provided on the oscillator and counter with only the output device unique to the particular application. Automobile applications for COS/MOS circuits are almost endless. One can think of speed controllers, digital speedometers, miles per gallon indicators, and perhaps even estimated-time-of-arrival indicators that, on the basis of the given total mileage, would update the time on a dynamic basis from information provided by the speedometer, odometer, and clock.

CONCLUSIONS

The primary advantage of electronic timing circuits over conventional mechanical methods of timekeeping lies in the greatly increased accuracy permitted by the highly stable crystal-controlled oscillator circuit. Although crystal oscillator circuits have existed for some time, their usefulness in portable applications has been somewhat limited because of the high current consumption required by the following digital logic. The advent of COS/MOS integrated circuits now permits the design of complete low-power timing systems. The impact of COS/MOS on timing applications is perhaps equalled by the recent development of liquid-crystal displays and dc-to-dc converters that allow low-power continuously operating digital displays. Certainly, no great technological barriers now exist for the use of electronic timing circuits in a wide variety of applications. The search, no doubt, will always continue for the ideal timekeeping device; however, it should be apparent from the information presented that the ideal timekeeping unit can now be more closely approached than ever before.

REFERENCES

1. Eaton, S.S., "Micropower Crystal-Controlled Oscillator Design Using RCA COS/MOS Inverters," RCA Application Note ICAN 6539, 1971.
2. "Frequency Control Devices," Catalog No. 670, Northern Engineering Laboratories, Burlington, Wisconsin.
3. Yoda, H., "Low Power Crystal Oscillator for Electronic Wrist Watch," Mihon Dempa Kogyo Co., Ltd., Japan, 1971.
4. Schindler, H.C., "Liquid Crystal Dynamic Scattering for Display Devices," RCA Publication PE-533, 1972.
5. Eveready Battery Applications Engineering Data, Union Carbide Corp., 1971.

# ICAN-6101

## The RCA COS/MOS Phase-Locked-Loop A Versatile Building Block for Micro-Power Digital and Analog Applications

### INTRODUCTION

Phase-locked-loops (PLL's), especially in monolithic form, are finding significantly increased usage in signal-processing and digital systems. FM demodulation, FSK demodulation, tone decoding, frequency multiplication, signal conditioning, clock synchronization, and frequency synthesis are some of the many applications of a PLL. The PLL described in this Note is the COS/MOS CD4046A, which consumes only 600 microwatts of power at 10 kHz, a reduction in power consumption of 160 times when compared to the 100 milliwatts required by similar monolithic bipolar PLL's. This power reduction has particular significance for portable battery-operated equipment. This Note discusses the basic fundamentals of phase-locked-loops, and presents a detailed technical description of the COS/MOS PLL as well as some of its applications.

### REVIEW OF PLL FUNDAMENTALS

The basic phase-locked-loop system is shown in Fig. 1; it consists of three parts: phase comparator, low-pass filter, and voltage-controlled oscillator (VCO); all are connected to form a closed-loop frequency-feedback system.

With no signal input applied to the PLL system, the error voltage,  $V_e(t)$ , at the output of the phase comparator is zero. The voltage,  $V_d(t)$ , from the low-pass filter is also zero, which causes the VCO to operate at a set frequency,  $f_0$ , called the center frequency. When an input signal is applied to the PLL, the phase comparator compares the phase and frequency of the signal input with the VCO frequency and generates an error voltage proportional to the phase and frequency

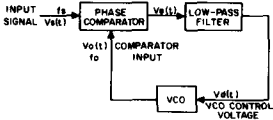

Fig. 1—Block diagram of PLL.

difference of the input signal and the VCO. The error voltage,  $V_e(t)$ , is filtered and applied to the control input of the VCO;  $V_d(t)$  varies in a direction that reduces the frequency difference between the VCO and signal-input frequency. When the input frequency is sufficiently close to the VCO frequency, the closed-loop nature of the PLL forces the VCO to lock in frequency with the signal input; i.e., when the PLL is in lock, the VCO frequency is identical to the signal input except for a finite phase difference. The range of frequencies over which the PLL can maintain this locked condition is defined as the lock range of the system. The lock range is always larger than the band of frequencies over which the PLL can acquire a locked condition with the signal input. This latter band of frequencies is defined as the capture range of the PLL system.

### TECHNICAL DESCRIPTION OF COS/MOS PLL

Fig. 2 shows a block diagram of the COS/MOS CD4046A, which has been implemented on a single monolithic integrated circuit. The PLL structure consists of a low-power, linear, voltage-controlled oscillator (VCO), and two different phase comparators having a common signal-input amplifier and a common comparator input. A 5.2-volt zener is provided for supply regulation if necessary. The VCO can be connected either directly or through frequency dividers to the comparator input of the phase comparators. The low-pass filter is implemented through external parts because of the radical configuration changes from application to application and because some of the components are non-integrable. The CD4046A is supplied in a 16-lead, dual-in-line, ceramic package (CD4046AD); a 16-lead, dual-in-line, plastic package (CD4046AE); or a 16-lead flat-pack (CD4046AK). It is also available in chip form (CD4046AH).

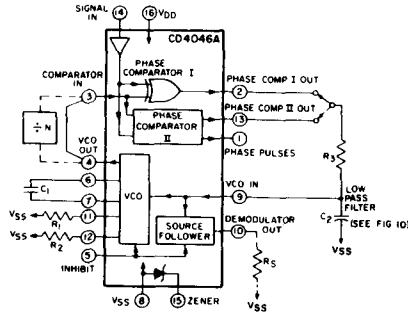

Fig. 2—COS/MOS PLL block diagram.

### Phase Comparators

Most PLL systems utilize a balanced mixer composed of well-controlled analog amplifiers for the phase-comparator section. Analog amplifiers with well-controlled gain characteristics cannot easily be realized using COS/MOS technology. Hence, the COS/MOS design shown in Fig. 3 employs digital-type phase comparators. Both phase comparators are driven by a common-input amplifier configuration composed of a bias stage and four inverting-amplifier stages. The phase-comparator signal input (terminal 14) can be direct-coupled provided the signal swing is within COS/MOS logic levels [logic 0  $\leq$  30% (VDD-VSS), logic 1  $\geq$  70% (VDD-VSS)]. For smaller input signal swings, the signal must be capacitively coupled to the self-biasing amplifier at the signal input to insure an over-driven digital signal into the phase comparators.

Phase-comparator I is an exclusive-OR network; it operates analogously to an over-driven balanced mixer. To maximize the lock range, the signal and comparator input frequencies must have 50-percent duty cycle. With no signal or noise on the signal input, this phase comparator has

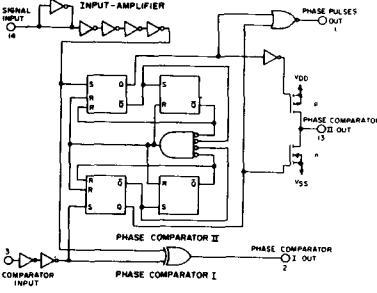

Fig. 3—Schematic of COS/MOS PLL phase-comparator section.

an average output voltage equal to  $V_{DD}/2$ . The low-pass filter connected to the output of phase-comparator I supplies the averaged voltage to the VCO input, and causes the VCO to oscillate at the center frequency ( $f_0$ ). With phase-comparator I, the range of frequencies over which the PLL can acquire lock (capture range) is dependent on the low-pass-filter characteristics, and can be made as large as the lock range. Phase-comparator I enables a PLL system to remain in lock in spite of high amounts of noise in the input signal.

One characteristic of this type of phase comparator is that it may lock onto input frequencies that are close to harmonics of the VCO center-frequency. A second characteristic is that the phase angle between the signal and the comparator input varies between  $0^\circ$  and  $180^\circ$ , and is  $90^\circ$  at the center frequency. Fig. 4 shows the typical, triangular, phase-to-output, response characteristic of phase-comparator I. Typical waveforms for a COS/MOS phase-locked-loop employing phase-comparator I in locked condition of  $f_0$  is shown in Fig. 5.

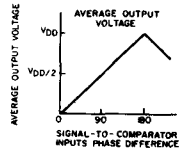

Fig. 4—Phase-comparator I characteristics at low-pass filter output.

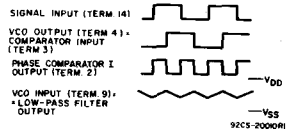

Fig. 5—Typical waveforms for COS/MOS phase-locked loop employing phase-comparator I in locked condition of  $f_0$ .

Phase-comparator II is an edge-controlled digital memory network. It consists of four flip-flop stages, control gating, and a three-state output circuit comprising p and n drivers having a common output node as shown in Fig. 3. When the p-MOS or n-MOS drivers are ON, they pull the output up to  $V_{DD}$  or down to  $V_{SS}$ , respectively. This type of phase comparator acts only on the positive edges of the signal- and comparator-input signals. The duty cycles of the signal and comparator inputs are not important since positive transitions control the PLL system utilizing this type of comparator. If the signal-input frequency is higher than the comparator-input frequency, the p-MOS output driver is maintained ON continuously. If the signal-input frequency is lower than the comparator-input frequency, the n-MOS output driver is maintained ON continuously. If the signal- and comparator-input frequencies are the same, but the signal input lags the comparator input in phase, the n-MOS output driver is maintained ON for a time corresponding to the phase difference. If the signal- and comparator-input frequencies are the same, but the signal input leads the comparator input in phase, the p-MOS output driver is maintained ON for time corresponding to the phase difference. Subsequently, the capacitor voltage of the low-pass filter connected to this type of phase comparator is adjusted until the signal and comparator input are equal in both phase and frequency. At this stable operating point, both p- and n-MOS output drivers remain OFF, and thus the phase-comparator output becomes an open circuit and holds the voltage on the capacitor of the low-pass filter constant. Moreover, the signal at the "phase pulses" output is at a high level, and can be used for indicating a locked condition. Thus, for phase-comparator II, no phase difference exists between signal and comparator input over the full VCO frequency range. Moreover, the power dissipation due to the low-pass filter is reduced when this type of phase comparator is used because both the p- and n-MOS output drivers are OFF for most of the signal-input cycle. It should be noted that the PLL lock range for this type of phase comparator is equal to the capture range, independent of the low-pass filter. With no signal present at the signal input, the VCO is adjusted to its lowest frequency for phase-comparator II. Fig. 6 shows typical waveforms for a COS/MOS PLL employing phase-comparator II in a locked condition.

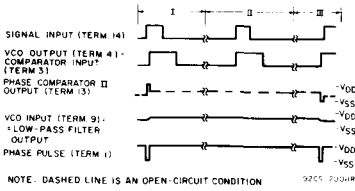

Fig. 6—Typical waveforms for COS/MOS phase-locked loop employing phase-comparator II in locked condition.

Fig. 7 shows the state diagram for phase-comparator II; each circle represents a state of the comparator. The number at the top inside each circle represents the state of the comparator, while the logic state of the signal and comparator inputs, represented by a 0 or a 1, are given by the left and right numbers, respectively, at the bottom of each circle. The transitions from one state to another result from either a logic change on the signal input (I) or the comparator input (C). A positive transition and a negative transition are shown by an arrow pointing up or down, respectively. The state diagram assumes that only one transition on either the signal input or the comparator input occurs at any instant. States 3, 5, 9, and 11 represent the condition at the output of phase-comparator II when the p-MOS driver is ON, while states 2, 4, 10, and 12 determine the condition when the n-MOS driver is ON. States 1, 6, 7, and 8 represent the condition when the output of phase-comparator II is in its high impedance state; i.e., both p- and n-devices are OFF, and the phase-pulses output (terminal 1) is high. The condition at the phase-pulses output for all other states is low.

As an example of how one may use the state diagram shown in Fig. 7, consider the operation of phase-comparator II in the locked condition shown in Fig. 6. The waveforms shown in Fig. 6 are broken up into three sections: section I corresponds to the condition in which the signal input leads the comparator input in phase, while section II corresponds to a finite phase difference. Section III depicts the condition when the comparator input leads the signal input in phase. These three sections all correspond to a locked condition for the COS/MOS PLL; i.e., both signal- and comparator-input signals are of the same frequency but differ slightly in phase. Assume that both the signal inputs begin in the 0 state, and that phase-comparator II is initially in its high-impedance output condition (state 1), as shown in Figs. 7 and 6, respectively. The signal input makes a positive transition

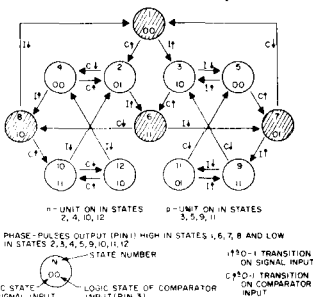

Fig. 7—State diagram of phase-comparator II.

first, which brings phase-comparator II to state 3. State 3 corresponds to the condition of the comparator in which the signal input is a 1, the comparator input is a 0, and the output p-device is ON. The comparator input goes high next, while the signal input is high, thus bringing the comparator to state 6, a high-impedance output condition. The signal input goes to zero next, while the comparator input is high, which corresponds to state 7. The comparator input goes low next, bringing phase-comparator II back to state 1. As shown for section I, the p-device stays on for a time corresponding to the phase difference between the signal input and the comparator input. Starting in state 1 at the beginning of section III, the comparator input goes high first, while the signal input is low, bringing the comparator to state 2.

Following the example given for section I, the comparator proceeds from state 2 to states 6 and 8 and then back to 1. The output of phase-comparator II for section III corresponds to the n-device being on for a time corresponding to the phase difference between the signal and comparator inputs.

The state diagram of phase-comparator II completely describes all modes of operation of the comparator for any input condition in a phase-locked-loop.

**Voltage-Controlled Oscillator**

Fig. 8 shows the schematic diagram of the voltage-controlled oscillator (VCO). To assure low system-power dissipation, it is desirable that the low-pass filter consume little power. For example, in an RC filter, this requirement dictates that a high-value R and a low-value C be utilized. The VCO input must not, however, load down or modify the characteristics of the low-pass filter. Since the VCO design shown utilizes an n-MOS input configuration having practically infinite input resistance, a great degree of freedom is allowed in selection of the low-pass filter components.

The VCO circuit shown in Fig. 8 operates as follows: when the inhibit input is low, P<sub>3</sub> is turned full ON, effectively connecting the sources of P<sub>1</sub> and P<sub>2</sub> to V<sub>DD</sub>, and gates 1 and 2 are permitted to function as NOR-gate flip-flops. N<sub>1</sub> together with external-resistor R<sub>1</sub> form a source-follower configuration. As long as the resistance of R<sub>1</sub> is at least an order of magnitude greater than ON resistance of N<sub>1</sub> (greater than 10 kilohms), the current through R<sub>1</sub> is linearly dependent on the VCO input voltage. This current flows through P<sub>1</sub>, which, together with P<sub>2</sub>, forms a current-mirror network. External resistor R<sub>2</sub> adds an additional constant current through P<sub>1</sub>; this current offsets the VCO operating frequency for VCO input signals of 0 volts. In the current-mirror network, the current of P<sub>2</sub> is effectively equal to the current through P<sub>1</sub> independent of the drain voltage at P<sub>2</sub>. (This condition is true provided P<sub>2</sub> is maintained in saturation; in the circuit shown, P<sub>2</sub> is saturated under all possible operating conditions and modes). The set/reset flip-flop composed of gates 1 and 2 turns ON either P<sub>4</sub> and N<sub>3</sub>, or P<sub>5</sub> and N<sub>2</sub>. One side of the external capacitor C<sub>1</sub> is, therefore, held at ground, while the other side is charged by the constant current supplied by P<sub>2</sub>. As soon as C<sub>1</sub> charges to the point at which the transfer point of inverters 1 or 5 is reached, the flip-flop changes state. The

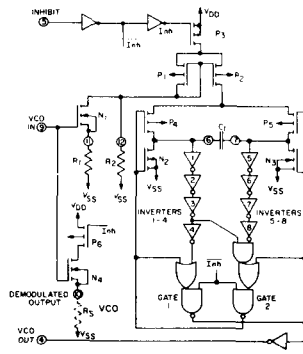

Fig. 8—Schematic of COS/MOS VCO section.

charged side of the capacitor is now pulled to ground. The other side of the capacitor goes negative, and discharges rapidly through the drain diode of the OFF n-device. Subsequently, a new half-cycle starts. Since inverters 1 and 5 have the same transfer points, the VCO has a 50-percent duty-cycle. Inverters 1 through 4 and 5 through 8 serve several purposes: (1) they shape the slow-input ramp from capacitor C<sub>1</sub> to a fast waveform at the flip-flop input stage, (2) they maintain low power dissipation through the use of high-impedance devices at inverters 1 and 5 (slow-input wave-forms), and (3) they provide four inverter delays before removal of the set/reset flip-flop triggering pulse to assure proper toggling action.

In order not to load the low-pass filter, a source-follower output of the VCO input voltage is provided (demodulated output). If this output is used, a load resistor (R<sub>s</sub>) of 10 kilohms or more should be connected from this terminal to ground. If unused, this terminal should be left open. A logic 0 on the inhibit input enables the VCO and the source follower, while a logic 1 turns off both to minimize stand-by power consumption.

**Performance Summary of COS/MOS PLL**

The maximum ratings for the CD4046A COS/MOS PLL, as well as its general operating-performance characteristics are outlined in Table I. The VCO and comparator characteristics are shown in Tables II and III, respectively. Table IV summarizes some useful formulas as a guide for approximating the values of external components for the CD4046A in a phase-locked-loop system. When using Table IV, one should keep in mind that frequency values are in kilohertz, resistance values are in kilohms, and capacitance values are in microfarads. The selected external components must be within the following ranges:

$$10 \text{ K}\Omega \leq R_1, R_2, R_s \leq 1 \text{ M}\Omega$$

$$C_1 \geq 100 \text{ pF at } V_{DD} \geq 5 \text{ V}$$

$$C_1 \geq 50 \text{ pF at } V_{DD} \geq 10 \text{ V}$$

In addition to the given design information, refer to Fig. 9 for R<sub>1</sub>, R<sub>2</sub>, and C<sub>1</sub> component selections. The use of Table IV in designing a COS/MOS PLL system for some familiar applications is discussed below.

**APPLICATIONS OF THE COS/MOS PLL**

The COS/MOS phase-locked-loop is a versatile building block suitable for a wide variety of applications, such as FM demodulators, frequency synthesizers, split-phase data synchronization and decoding, and phase-locked-loop lock detection.

**FM Demodulation**

When a phase-locked-loop is locked on an FM signal, the voltage-controlled oscillator (VCO) tracks the instantaneous frequency of that signal. The VCO input voltage, which is the filtered error voltage from the phase detector, corresponds to the demodulated output. Fig. 11 shows the connections for the COS/MOS CD4046A PLL as an FM demodulator. For this example, an FM signal consisting of a 10-kilohertz carrier frequency was modulated by a 400-Hz audio signal. The total FM signal amplitude is 500 millivolts, therefore the signal must be ac coupled to the signal input (terminal 14).

Table I—Maximum ratings and general operating characteristics

**MAXIMUM RATINGS, Absolute-Maximum Values:**

Storage Temperature Range	.....	-65°C to +150 °C
Operating Temperature Range	.....	-55°C to +125 °C
Ceramic Package Types	.....	40°C to +85 °C
Plastic Package Types	.....	200 mW
DC Supply Voltage Range	.....	V <sub>DD</sub> ≤ V <sub>SS</sub>
(V <sub>DD</sub> - V <sub>SS</sub> )	.....	0.5 V to +15 V
Device Dissipation (Per Pkg.)	.....	200 mW
All Inputs	.....	V <sub>SS</sub> ≤ V <sub>i</sub> ≤ V <sub>DD</sub>
Recommended	.....	5 to 15 V
DC Supply Voltage (V <sub>DD</sub> , V <sub>SS</sub> )	.....	5 to 15 V
Recommended	.....	V <sub>DD</sub> to V <sub>SS</sub>
Input Voltage Swing	.....	V <sub>DD</sub> to V <sub>SS</sub>

**General Characteristics (Typical Values at V<sub>DD</sub> = V<sub>SS</sub> = 10 V and T<sub>A</sub> = 25°C)**

Operating Supply Voltage (V <sub>DD</sub> = V <sub>SS</sub> )	.....	5 to 15 V
Operating Supply Current	.....	70 μW
Inhibit = "0"	f <sub>0</sub> = 10 kHz, V <sub>DD</sub> = 5 V	70 μW
@ C <sub>1</sub> = 0.0001 μF		
R <sub>1</sub> = 1 MΩ	f <sub>0</sub> = 10 kHz, V <sub>DD</sub> = 10 V	600 μW
Inhibit = "1"		25 μA

# ICAN-6101

Table II— VCO electrical characteristics

VCO Characteristics (Typical Values at  $V_{DD} - V_{SS} = 10\text{ V}$  and  $T_A = 25^\circ\text{C}$ )

Maximum Frequency	1.2 MHz
Temperature Stability	800 ppm/°C
Linearity ( $V_{VCO\text{ in}} = 5\text{ V} \pm 2.5\text{ V}$ )	1%
Center Frequency	Programmable with $R_1$ and $C_1$
Frequency Range	Programmable with $R_1, R_2$ , and $C_1$
Input Resistance	$10^{12}\ \Omega$
Output Voltage	10 V p-p
Duty Cycle	50%
Rise & Fall Times	50 ns
Output Current Capability	
"1" Drive @ $V_O = 9.5\text{ V}$	-1.8 mA
"0" Sink @ $V_O = 0.5\text{ V}$	2.6 mA
Demodulated Output:	
Offset Voltage	$ V_{VCO\text{ in}} - V_{DEMOD\text{ out}}  @ 1\text{ mA}, 1.5\text{ V}$

Table III — Comparator electrical characteristics  
Comparator Characteristics (Typical Values at  $V_{DD} - V_{SS} = 10\text{ V}$  and  $T_A = 25^\circ\text{C}$ )

Signal Input	
Input Impedance	400 K $\Omega$
Input Sensitivity	
ac coupled	400 mV
dc coupled	$\left\{ \begin{array}{l} "0" < 30\% (V_{DD} - V_{SS}) \\ "1" > 70\% (V_{DD} - V_{SS}) \end{array} \right.$
Comparator Input Levels (term. 3):	$\left\{ \begin{array}{l} "0" < 30\% (V_{DD} - V_{SS}) \\ "1" > 70\% (V_{DD} - V_{SS}) \end{array} \right.$
Output Current Capability	
Comparator I (term. 2) and Comparator II (term. 13):	
"1" Drive @ $V_O = 9.5\text{ V}$	-1.8 mA
"0" Sink @ $V_O = 0.5\text{ V}$	2.6 mA
Comparator II Phase Pulses (term. 1):	
"1" Drive @ $V_O = 9.5\text{ V}$	-0.5 mA
"0" Sink @ $V_O = 0.5\text{ V}$	1.4 mA

Phase-comparator I is used for this application because a PLL system with a center frequency equal to the FM carrier frequency is needed. Phase comparator I lends itself to this application also because of its high signal-input-noise-rejection characteristics.

The formulas shown in Table IV for phase-comparator I with  $R_2 = \infty$  are used in the following considerations. The center frequency of the VCO is designed to be equal to the carrier frequency, 10 kHz. The value of capacitor  $C_1$ , 500 pF, was found by assuming an  $R_1 = 100\text{ K}\Omega$  for a supply voltage  $V_{DD} = 5\text{ volts}$ .

These values determined the center frequency:  
 $f_0 = 10\text{ kHz}$

The PLL was set for a capture-range of

$$f_c \approx \pm \frac{1}{2\pi} \sqrt{\frac{2\pi f_0}{R_3 C_2}} = \pm 0.4\text{ kHz}$$

to allow for the deviation of the carrier frequency due to the audio signal. The components shown in Fig. 10 for the low-pass filter ( $R_3 = 100\text{ k}\Omega, C_2 = 0.1\ \mu\text{F}$ ) determine the above capture frequency.

The total current drain at a supply voltage of 5 volts for this FM-demodulator application is 132 microamperes for a 4 dB S/N-ratio on the signal input, and 90 microamperes for a 10dB S/N ratio. The power consumption decreases because the signal-input amplifier goes into saturation at higher input levels.

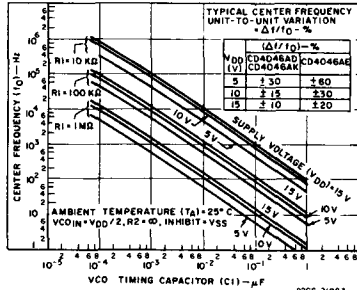

Fig. 9(a)— Typical center frequency vs.  $C_1$  for  $R_1 = 10\text{ K}\Omega, 100\text{ K}\Omega,$  and  $1\text{ M}\Omega$ .

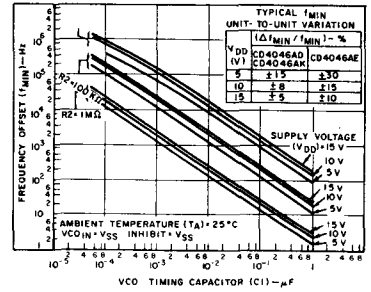

Fig. 9(b)— Typical frequency offset vs.  $C_1$  for  $R_2 = 10\text{ K}\Omega, 100\text{ K}\Omega,$  and  $1\text{ M}\Omega$ .

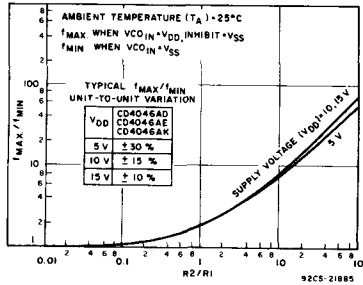

Fig. 9(c)— Typical  $f_{\text{max}}/f_{\text{min}}$  vs.  $R_2/R_1$ .

CHARACTERISTICS	USING PHASE COMPARATOR I		USING PHASE COMPARATOR II	
	VCO WITHOUT OFFSET $R_2 = \infty$	VCO WITH OFFSET	VCO WITHOUT OFFSET $R_2 = \infty$	VCO WITH OFFSET
VCO Frequency				
For No Signal Input	VCO in PLL system will adjust to center frequency, $f_0$		VCO in PLL system will adjust to lowest operating frequency, $f_{\text{min}}$	
Frequency Lock Range, $2f_L$	$2f_L = \text{full VCO frequency range}$ $2f_L = f_{\text{max}} - f_{\text{min}}$			
Frequency Capture Range, $2f_C$		(1), (2) $2f_C = \frac{1}{\pi} \sqrt{\frac{2\pi f_0}{R_1}}$		
Loop Filter Component Selection			$f_c = f_L$	
Phase Angle between Signal and Comparator	$90^\circ$ at center frequency ( $f_0$ ), approximating $0^\circ$ and $180^\circ$ at ends of lock range ( $2f_L$ )		Always $0^\circ$ in lock	
Locks on Harmonics of Center Frequency	Yes		No	
Signal Input Noise Rejection	High		Low	
VCO Component Selection	- Given $f_0$ - Use $f_0$ with Fig. 9a to determine $R_1$ and $C_1$	- Given $f_0$ and $f_L$ - Calculate $f_{\text{min}}$ from the equation $f_{\text{min}} = f_0 - f_L$ - Use $f_{\text{min}}$ with Fig. 9b to determine $R_2$ and $C_1$ - Calculate $f_{\text{min}}$ from the equation $f_{\text{max}} = f_0 + f_L$ - Use $f_{\text{min}}$ with Fig. 9c to determine $R_2/R_1$ to obtain $R_1$	- Given $f_{\text{min}}$ & $f_{\text{max}}$ - Calculate $f_0$ from the equation $f_0 = \frac{f_{\text{max}} + f_{\text{min}}}{2}$ - Use $f_0$ with Fig. 9a to determine $R_1$ and $C_1$	- Given $f_{\text{min}}$ & $f_{\text{max}}$ - Use $f_{\text{min}}$ with Fig. 9b to determine $R_2$ and $C_1$ - Calculate $f_{\text{min}}$ from the equation $f_{\text{max}} = f_0 + f_L$ - Use $f_{\text{min}}$ with Fig. 9c to determine $R_2/R_1$ to obtain $R_1$

For further information, see (1) F. Gardner, "Phase-Lock Technique," John Wiley and Sons, New York, 1966 (2) G. S. Moschytz, "Miniaturized RC Filters Using Phase-Locked Loop," BSTJ, May, 1966.

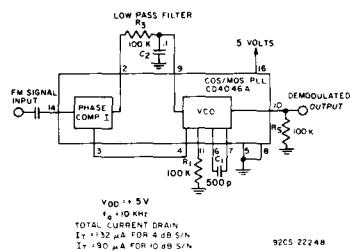

Fig. 10— FM demodulator.

Fig. 11 shows the performance of the FM/demodulator circuit of Fig. 10 at a 4 dB S/N-ratio. The demodulated output is taken off the VCO-input source follower using a resistor  $R_4$  ( $R_4 = 100\text{ k}\Omega$ ). The demodulation gain for this circuit is 250 mV/kHz.

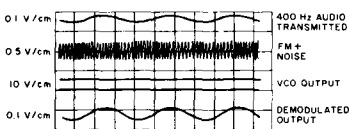

Fig. 11— Voltage waveforms of FM demodulator.

**Frequency Synthesizer**

The PLL system can function as a frequency-selective frequency multiplier by inserting a frequency divider into the feedback loop between the VCO output and the comparator input. Fig. 12 shows a COS/MOS low-frequency synthesizer with a programmable divider consisting of three decades,  $N$ , the frequency-divider modulus, can vary from 3 to 999 in steps of 1. When the PLL system is in lock, the signal and comparator inputs are at the same frequency and

$$f = N \times 1\text{ kHz}$$

Therefore, the frequency range of this synthesizer is 3 to 999 kHz in 1-kHz increments, which is programmable by the switch position of the Divide-by-N counter.

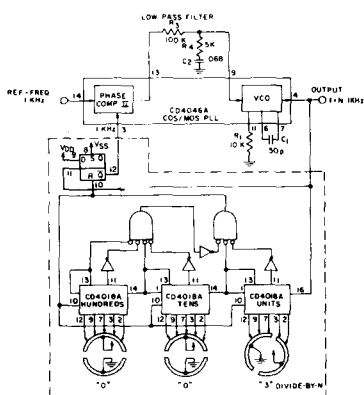

Fig. 12— Low-frequency synthesizer with three-decade programmable divider.

Phase-comparator II is used for this application because it will not lock on harmonics of the signal-input reference frequency (phase-comparator I does lock on harmonics). Since the duty cycle of the output of the Divide-by-N frequency divider is not 50 percent, phase-comparator II lends itself directly to this application.

Using the formulas for phase-comparator II shown in Table IV, the VCO is set up to cover a range of 0 to 1.1 MHz. The low-pass filter for this application is a two-pole, lag-lead filter which enables faster locking for step changes in frequency. Fig. 13 shows the waveforms during switching between output frequencies of 3 and 903 kHz. The figure shows that the transient going towards 3 kHz on the VCO control voltage is overdamped, while the transient to 903 kHz is underdamped. This condition could be improved by changing the value of  $R_3$  in the low-pass filter by means of adjustment of the switch-position hundreds in the Divide-by-N counter.

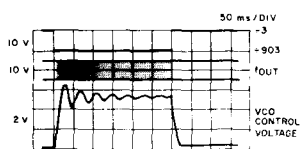

Fig. 13— Frequency-synthesizer waveforms.

**Split-Phase Data Synchronization and Decoding**

Fig. 14 shows another application of COS/MOS PLL, split-phase data synchronization and decoding. A split-phase data signal consists of a series of binary digits that occur at a periodic rate, as shown in waveform A in Fig. 14. The weight of each bit, 0 or 1, is random, but the duration of each bit, and therefore the periodic bit-rate, is essentially constant. To detect and process the incoming signal, it is necessary to have a clock that is synchronous with the incoming data signal. Phase-lock techniques can be utilized to recover the clock and the data. Timing information is contained in the data transitions, which can be positive or negative in direction, but both polarities have the same meaning for timing recovery. The phase of the signal determines the binary bit weight. A binary 0 or 1 is a positive or negative transition, respectively, during a bit interval in split-phase data signals.

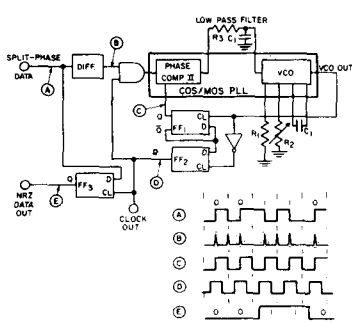

Fig. 14— Split-phase data synchronization and decoding.

As shown in Fig. 14, the split-phase data-input (A) is first differentiated to mark the locations of the data transitions. The differentiated signal, (B), which is twice the bit rate, is gated into the COS/MOS PLL. Phase-comparator II in the PLL is used because of its insensitivity to duty cycle on both the signal and comparator inputs. The VCO output is fed

into the clock input of FF1 which divides the VCO frequency by two. During the ON intervals, the PLL tracks the differentiated signal (B); during the OFF intervals the PLL remembers the last frequency present and still provides a clock output. The VCO output is inverted and fed into the clock input of FF2 whose data input is the inverted output of FF1. FF2 provides the necessary phase shift in signal (C) to obtain signal (D), the recovered clock signal from the split-phase data transmission. The output of FF3, (E), is the recovered binary information from the phase information contained in the split-phase data. Initial synchronization of this PLL system is accomplished by a string of alternating 0's and 1's that precede the data transmission.

**Phase-Locked-Loop Lock Detection**

In some applications that utilize a PLL, it is sometimes necessary to have an output indication of when the PLL is in lock. One of the simplest forms of lock-condition indicator is a binary signal. For example, a 1 or a 0 output from a lock-detection circuit would correspond to a locked or unlocked condition, respectively. This signal could, in turn, activate circuitry utilizing a locked PLL signal. This detection could also be used in frequency-shift-keyed (FSK) data transmissions in which digital information is transmitted by switching the input frequency between either of two discrete input frequencies, one corresponding to a digital 1 and the other to a digital 0.

Fig. 15 shows a lock-detection scheme for the COS/MOS PLL. The signal input is switched between two discrete frequencies of 20 kHz and 10 kHz. The PLL system uses

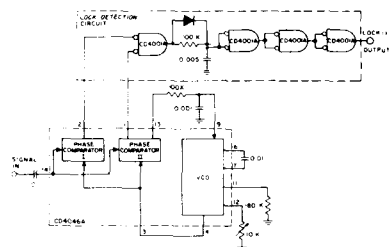

Fig. 15— Lock-detection circuit.

phase-comparator II; the VCO bandwidth is set up for an  $f_{min}$  of 9.5 kHz and an  $f_{max}$  of 10.5 kHz. Therefore, the PLL locks and unlocks on the 10-kHz and 20-kHz signals, respectively. When the PLL is in lock, the output of phase-comparator I is low except for some very short pulses that result from the inherent phase difference between the signal and comparator inputs; the phase-pulses output (terminal 1) is high except for some very small pulses resulting from the same phase difference. This low condition of phase comparator I is detected by the lock-detection circuit shown in Fig. 15. Fig. 16 shows the performance of this circuit when the input signal is switched between 20 and 10 kHz. It can be seen that after about five input cycles the lock detection signal goes high.

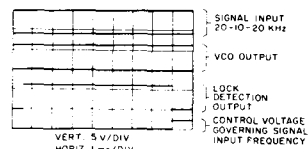

Fig. 16— Lock-detection-circuit waveforms.

# ICAN-6230

## Using the CD4047A in COS/MOS Timing Applications

by J. Paradise

Many applications exist today for COS/MOS multivibrators—both oscillators and one-shots—in analog and digital circuits. The requirements for these applications vary widely in such parameters as voltage range, temperature stability, power dissipation, drive capability, and external-component cost. No design is optimum for all of the above considerations. However, the RCA-CD4047A Monostable/Astable Multivibrator fulfills the needs of most applications in this timing area. It can function as either an oscillator or one-shot with many additional features, and will meet the power dissipation, stability, and speed requirements of most COS/MOS systems.

This Note compares some simpler types of oscillator circuits with the CD4047A in both theoretical and actual performance, and provides application information on the CD4047A which should prove useful to COS/MOS circuit and system designers.

### COS/MOS DISCRETE RC OSCILLATOR

The simplest type of RC-oscillator is shown in Fig. 1. It consists of two inverters (which may be taken from standard

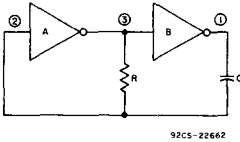

Fig. 1—Simplest COS/MOS RC oscillator.

RCA COS/MOS parts, i.e., CD4007A, CD4001A, CD4011A, etc.) and a single resistor and capacitor. The operating waveforms for this circuit are shown in Fig. 2.

The circuit operates as follows: depending on the output levels of inverters A and B, at any instant C will be charging or discharging through R. When the waveform at point (2) in the circuit passes through the transfer voltage of inverter A, this inverter will switch and cause inverter B to switch. Subsequently, the waveform at point (2) would be exponentially

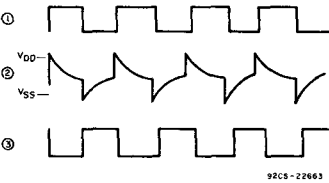

Fig. 2—RC-oscillator operating waveforms.

increasing or decreasing with discontinuities equal in magnitude to  $V_{DD}$  during the instant of switching. However, since point (2) is protected by a standard input-protection circuit common to COS/MOS devices, the waveform is clamped at one diode voltage drop above  $V_{DD}$  and below  $V_{SS}$ . (Refer to waveforms in Figs. 2 and A1). The calculations for the period of this multivibrator circuit are shown in Appendix A; the final equation for the period T is

$$T = -RC \ln \frac{(V_{TR})(V_{DD} - V_{TR})}{(V_{DD} + V_D)^2} \quad (1)$$

where  $V_{TR}$  is the switching or transfer point of the inverter, and  $V_D$  is the diode forward voltage drop.

Equation (1) shows that the period of the multivibrator, T, is sensitive to changes in  $V_{DD}$ , as illustrated by the graph of time period, T, vs transfer voltage as a function of  $V_{DD}$  in Fig. 3. In addition to the strong dependence of actual time period on the  $V_{DD}$  chosen, the graph also illustrates that, for a given  $V_{DD}$ , a full transfer voltage spread of 30 to 70 per cent of  $V_{DD}$  (unit-to-unit worst-case variations) yields a change in time period of about 10 per cent from the nominal 50-per-cent transfer-voltage percentage values.

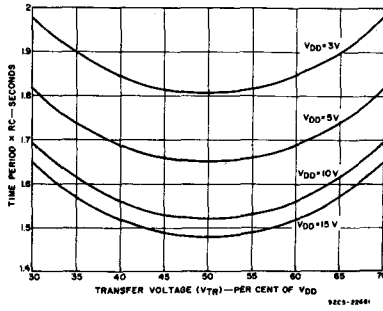

Fig. 3—Discrete RC-oscillator time period as a function of transfer voltage.

The above analysis is valid only at low frequencies (i.e., less than 50 kHz). As the multivibrator frequency approaches this value, other considerations must be taken into account:

1. The input protection circuit has a  $V_{DD}$  diode with a finite resistance and capacitance; the diode will discharge at the rate associated with this small time constant.
2. In the negative direction, there is a diode as well as a series protection resistor (1 to 3 kilohms); the time constant of this diode is even longer than that of the  $V_{DD}$  diode.
3. The propagation delay of the inverters is added to the time period during each charge and discharge cycle. Since the delay is a function of  $V_{DD}$ , small changes in  $V_{DD}$  at high frequencies will cause the time period to vary.
4. There is a finite output impedance associated with the inverter which is in series with the external timing resistor. Since this output impedance also changes with  $V_{DD}$ , at high frequencies where the external resistor becomes small, the multivibrator stability decreases with small variations in  $V_{DD}$ .

The negative features of the input protection circuit can be partially compensated for by the addition of a resistor,  $R_S$ , in series with the input protection circuit, as shown in Fig. 4. Although the input inverter A is still clamped at one diode drop above  $V_{DD}$  or one diode drop below  $V_{SS}$ , the waveform at point (4) is allowed to swing well above  $V_{DD}$  and below  $V_{SS}$ . The larger swing reduces the dependency of transfer-voltage variations upon stability; the variable characteristics of the input protection circuit and their effect upon stability are greatly reduced. An analysis of this circuit is presented in

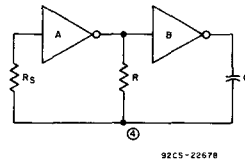

Fig. 4—RC-oscillator with the addition of  $R_S$ .

Appendix B; the equation for the period, T, for this circuit is shown in Eq. 2.

When  $K = \frac{R_S}{R}$ , T is:

$$T = -RC \ln \frac{(V_{TR})(V_{DD} - V_{TR})}{(V_{DD} + V_D)^2} - \frac{K}{(K+1)} RC \ln \frac{K[V_{DD} + V_D]}{K[V_{DD} + V_{TR}] + [V_{TR} - V_D]} - \frac{K}{(K+1)} RC \ln \frac{K[V_{DD} + V_D]}{K[2V_{DD} - V_{TR}] + [V_{DD} - V_{TR} - V_D]} \quad (2)$$

In this form it is easy to see that when K approaches zero, the circuit and associated waveforms are equivalent to those of Fig. A-1. On the other hand, as K approaches infinity, the variation in period as a function of  $V_{DD}$  is reduced to zero. This result is shown in Fig. 5, where period as a function of trans-

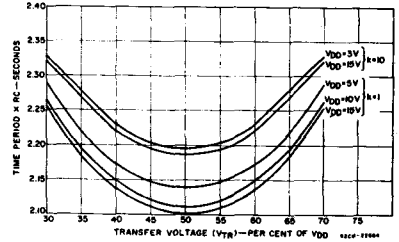

Fig. 5—Discrete RC-oscillator time period as a function of transfer voltage.

fer voltage is plotted for different values of  $V_{DD}$  and K, and Fig. 6, which shows period as a function of K for different values of  $V_{DD}$ . Variation in period with transfer voltage is also reduced as K increases. This variation decreases from 10 per cent for  $K = 0$  to about 5 per cent as K gets large.

There are some obvious limitations in the value of  $R_S$  that can be used. Besides the disadvantages in this circuit if R is to

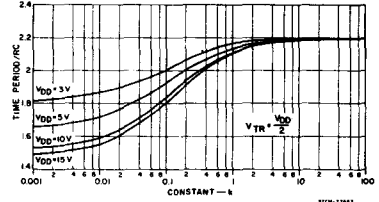

Fig. 6—Discrete RC-oscillator time period as a function of constant, K.

be made adjustable, the user must be careful with component layout, if  $R_S$  is made very large, to take advantage of the improvement in stability. A time constant and phase shift is produced by  $R_S$  and stray wiring and breadboard capacitance, see Fig. 7. This shift creates a switching delay in the circuit which changes the time period and, in addition, may cause spurious oscillations and glitches in the multivibrator circuit. A reasonable value for K would be anywhere from 2 to 10, with maximum and minimum values for  $R_S$  determined by the above considerations.

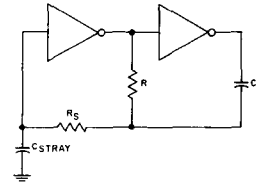

Fig. 7—RC-oscillator circuit with stray capacitance.

### COS/MOS INTEGRATED RC OSCILLATORS

The RCA-CD4047A is an integrated RC oscillator that eliminates most of the disadvantages of the discrete circuits previously discussed. The primary reason for this improved performance is the special input-protection circuit which allows the capacitor charging waveform to swing above  $V_{DD}$  and below  $V_{SS}$  without the need for an external resistor. This circuit, shown in Fig. 8, has the same time period and stability as the circuit in Fig. 4 for the case where the value of  $R_S$  is infinite. However, a resistor is eliminated, as well as the disadvantages of a time constant caused by the resistor.



There are two additional reasons for expected improvement with the CD4047A. First, the transfer-voltage point of the input inverter, A, is tested between 33 and 67 per cent of  $V_{DD}$  instead of between 30 and 70 per cent; this narrower test range improves stability by reducing unit-to-unit variations. In addition, large buffers are used for inverters D and E; this practice

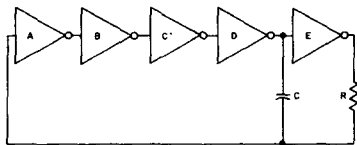

Fig. 8 - CD4047A oscillator section 92CS-22676

reduces the effect of changes of device output impedance with period stability. A derivation of period, T, for this circuit is presented in the Appendix C; the final equation for T becomes:

$$T = -RC \ln \frac{(V_{TR})(V_{DD} - V_{TR})}{(V_{DD} + V_{TR})(2V_{DD} - V_{TR})} \quad (3)$$

Figure 9 shows a graph of stability as a function of transfer voltage based on this equation.

The graph of Fig. 9 shows a maximum variation of 5 per cent between minimum (2.197 RC) and maximum (2.307 RC) time periods. A value of 2.25 RC yields a  $\pm 2.5$  per-cent variation. Typical values of period variations at high frequencies and temperature extremes are included in the published data for the CD4047A.<sup>1</sup>

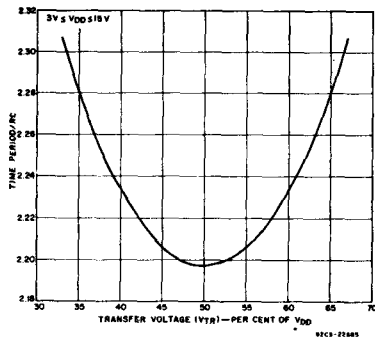

Fig. 9 - CD4047 time period as a function of transfer voltage. 92CS-22685

An additional advantage of the CD4047A is a reduction in power dissipation as compared to the discrete multivibrators discussed previously. Inverter A in Fig. 8 is designed with high-impedance components that limit power dissipation during the time that the inverter operates in the middle of its transfer region. Four additional inverters are used to gradually shift from a very-high-impedance inverter at the input to a very-low-impedance driver in series with the external timing resistor. Calculations for power dissipation and a comparison of  $P_{diss}$  for the CD4047A and a discrete oscillator are presented in Appendix D; the result is

$$P_{diss} = 2 CV^2 f \quad (4)$$

This equation specifies the power dissipated in the external components only. At low frequencies, where most of the power will be dissipated in R, power can be minimized by using a small value of C, since the formula shows the power is a function of C and not R.

Additional power is consumed in the CD4047A chip as a function of frequency. Fig. 10 shows curves for theoretical minimum power dissipation, actual CD4047A oscillator-power dissipation, and discrete oscillator-power dissipation as a function of frequency.

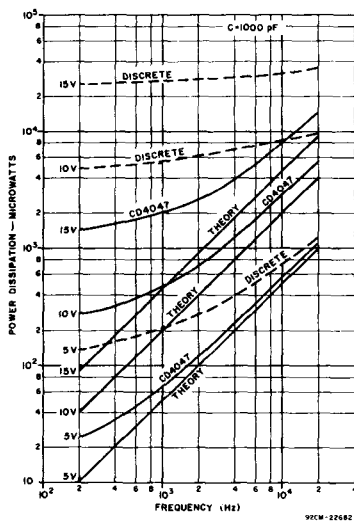

Fig. 10 - Comparison of  $P_{diss}$  for discrete oscillator and CD4047 with theory. 92CM-22682

CMOS DISCRETE ONE-SHOTS

Fig. 11 illustrates one of several simple monostable circuits which can be employed in non-critical timing circuits.<sup>2</sup> The

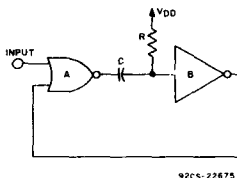

Fig. 11 - CMOS monostable circuit. 92CS-22675

circuit pulse width is dependent upon the transfer voltage of inverter B as time constant RC charges to  $V_{DD}$  from  $V_{SS}$ . The pulse width is defined as

$$T = -RC \ln \left( \frac{V_{DD} - V_{TR}}{V_{DD}} \right) \quad (5)$$

Fig. 12 shows the variation in pulse width as a function of transfer voltage for this device.

There are several alternatives to the circuit shown in Fig. 12.<sup>2</sup> These alternatives have the advantage of greater stability, but at the expense of two time constants required in circuit and, in some cases, the addition of a diode.

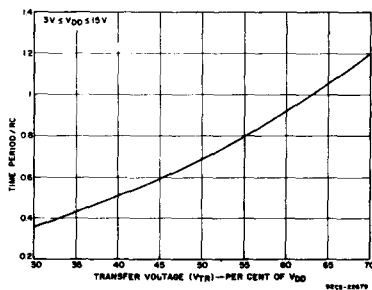

Fig. 12 - Simple one-shot time period as a function of transfer voltage. 92CS-22679

COS/MOS INTEGRATED ONE-SHOTS

The CD4047A, when used in the monostable mode, again has several advantages over discrete designs. A high degree of accuracy can be achieved with one time constant, and power dissipation is lower than with discrete designs. Fig. 13 shows that many functions can be achieved with the CD4047A, including leading and trailing-edge triggering, and retriggering.

The pulse width,  $T_M$ , is expressed below: its derivation is given in Appendix E.

$$T_M = -RC \ln \frac{(V_{TR})(V_{DD}) - V_{TR}}{(2V_{DD})(2V_{DD} - V_{TR})} \quad (6)$$

Fig. 14 is a graph of pulse width versus transfer voltage based on the above equation.

The equations for monostable-mode power dissipation are also derived in Appendix E. For a repetitive output on the CD4047A, power dissipation can be expressed by the following equation:

$$P_{diss} = \frac{2.875 CV_{DD}^2}{T_M} \times (\text{duty cycle}) \quad (7)$$

USING THE CD4047A - SPECIAL CONSIDERATIONS

A number of circuit considerations are explained below which will aid the user of the CD4047A.

A clamping circuit is provided on the chip to reduce the recovery time ( $t_r$ ) that would normally exist in other monostable circuits; see Figs. 15 and 16. Fig. 17 shows a plot of monostable-pulse-width stability as a function of duty cycle for specific R and C external components. Note that there is no appreciable change in pulse width until the duty cycle approaches 100 per cent. A disadvantage to the clamping circuit is that it introduces additional capacitance at the RC common node (Fig. 16), which may be noticeable for short pulse widths in the monostable mode only. Some diffusion capacitance present at the base of the n-p-n transistor is used to quickly charge C to  $V_{DD}$  after the one-shot cycle has terminated. This capacitance is multiplied by the beta of the transistor, and is in parallel with the external C during the time interval that the transistor is on ( $V_{DD} - V_{BE} < t < V_{BE}$ ). Thus, when values of C less than 1000 picofarads are used, the actual width will be longer than that predicted by the formula. Fig. 18 is a graph of actual, typical pulse widths as a function of external C used under these conditions. Note that the minimum values of C used in the graph are the smallest that can be used in the CD4047A to assure proper operation of the circuit.

The waveform in Fig. 15 shows that two positive transitions are encountered by the control circuitry in the CD4047A. These transitions are necessary to make the output flip-flop at pin 10 toggle properly to produce the single pulse needed in monostable operation. However, at pin 13, the waveform of Fig. 19 results; the pulse width of the spike is equivalent to the propagation delay of the circuit. This spike will normally prevent the user from using pin 13 in the monostable mode. In the astable mode, however, pin 13 can be used whenever a 50-per-cent duty cycle and higher drive capability are not required. The advantage to the use of pin 13 under these conditions is that the frequency of the waveform at pin 13 is twice that of pin 10 for the same external timing components.

When the CD4047A is used in the retrigger mode, the retrigger input is connected directly to the set input of FF4, as shown in Fig. 13. This connection means that the output at pin 10 will be high during the time that a high level is present on pin 12. Thus, if normal one-shot operation is required at any time that the circuit is in the retrigger mode, the input pulse should be shorter than the expected pulse at the output. Note that in the retrigger mode the output pulse width is not referenced to the last positive-going edge produced at the input because of the asynchronous nature of the circuit. The output actually terminates when two internal-oscillator leading edges have been received by FF4, after the high level present on pin 12 has been removed. The output width variation will then be between one and two time constants referenced to the trailing edge of the input at pin 12, see Fig. 20.

A section on timing-component limitations is presented in the CD4047A data sheet. It should be emphasized that it is desirable to use a small value of capacitance wherever possible.

# ICAN-6230

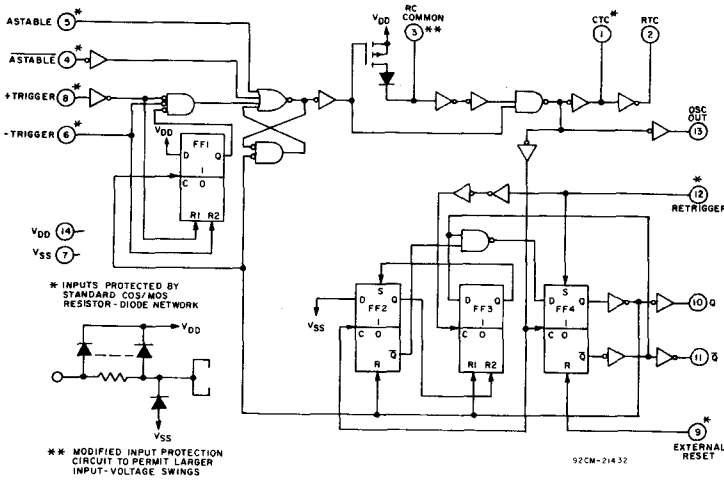

Fig. 13 - CD4047A logic diagram.

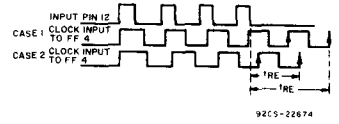

Fig. 20 - CD4047A retrigger-mode waveforms.

The circuit will work well even when the value of R approaches or exceeds 1 megohm. For very low frequencies, where a large value of capacitance is needed, the selection of the capacitor is very important. It must be nonpolarized because there is no reference ground at either of the two pins to which C is connected. The capacitor parallel resistance (i.e., leakage) must also be at least an order of magnitude higher than the external R used. This criterion generally eliminates electrolytic capacitors and those made of materials which could produce greater leakage current than that permitted for proper circuit operation.

Because of the internal circuit construction, there is no guarantee as to what dc level will be present on the output at pin 10 or 11 when power is first turned on. If this condition must be guaranteed, a system-power on pulse input to pin 9 can be made to assure that pin 10 will initially be at a low logic level. The pulse can be generated from one of the circuits shown in Fig. 21.

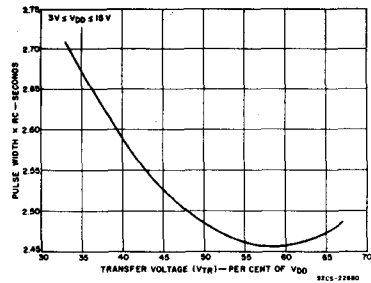

Fig. 14 - CD4047A one-shot pulse width as a function of transfer voltage.

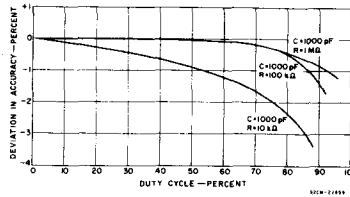

Fig. 17 - CD4047A monostable accuracy as a function of duty cycle.

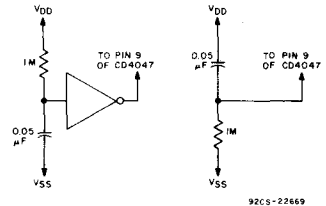

Fig. 21 - CD4047A power-up reset circuits.

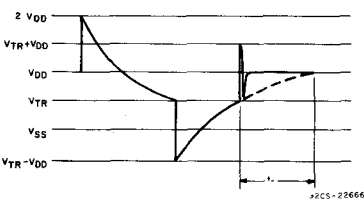

Fig. 15 - CD4047A one-shot RC waveform.

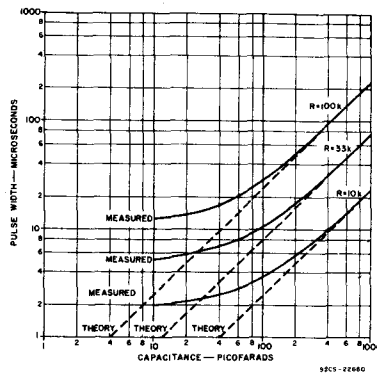

Fig. 18 - CD4047A pulse width as a function of capacitance.

Although the CD4047A data sheet calls for a minimum input pulse duration of 200 nanoseconds at 10 volts and 500 nanoseconds at 5 volts, shorter pulses (due to transients, etc.) occur frequently in system applications where the CD4047A is used. Such narrow pulses may not be ignored by the CD4047A, but may instead cause Q to go high permanently or until a reset input occurs. The circuit shown in Fig. 22 eliminates this problem by essentially "lengthening" the trigger pulse by feeding back through RA and CA a current pulse when Q goes from 0 to a 1. The particular values shown have been tried and found to work well, even for extremely short input pulses (less than 20 nanoseconds).

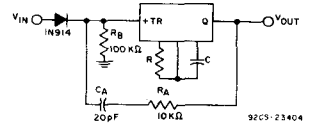

Fig. 22 - Input-pulse stretcher circuit.

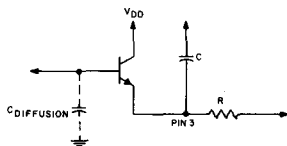

Fig. 16 - CD4047A clamping circuit.

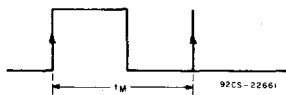

Fig. 19 - CD4047A one-shot output at pin 13.

## APPLICATIONS

### NOISE DISCRIMINATOR

Fig. 23 illustrates an application of the CD4047A in a noise-discriminator circuit. By adjusting the external time constant, a pulse width narrower than that determined by the time constant will be rejected by the circuit. The output pulse will

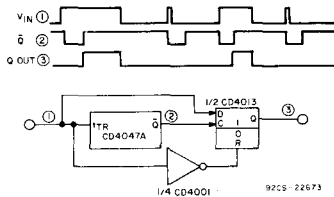

Fig. 23 - Noise-discriminator circuit.

follow the desired input, but the leading edge will be delayed by the selected time constant. Fig. 24 shows typical waveforms with the circuit in operation.

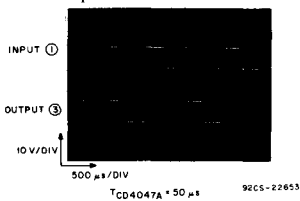

Fig. 24 - Noise-discriminator circuit waveforms.

### FREQUENCY DISCRIMINATOR

The CD4047A can be used as a frequency-to-voltage converter, as shown in Fig. 25. A waveform of varying frequency is applied to the +TR input. The one-shot will produce a pulse of constant width for each positive transition on the input. The

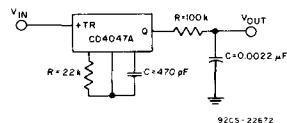

Fig. 25 - Frequency-discriminator circuit.

resultant pulse train is integrated to produce a waveform whose amplitude is proportional to the input frequency. The waveforms of Fig. 26 were taken with the circuit in operation.

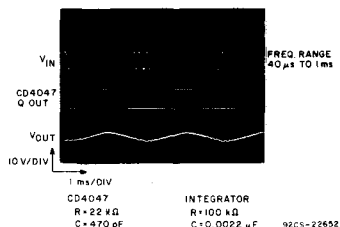

Fig. 26 - Frequency-discriminator-circuit waveforms.

### LOW-PASS FILTER

A simple circuit using the CD4047A as a low-pass filter is shown in Fig. 27. The time constant chosen for the multivibrator will determine the upper cutoff frequency for the filter. The circuit essentially compares the input frequency

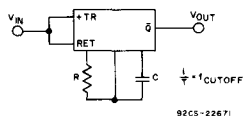

Fig. 27 - Low-pass filter circuit.

with its own reference, and produces an output which follows the input for frequencies less than  $f_{cutoff}$ , and a low output for frequencies greater than  $f_{cutoff}$ . Figs. 28 and 29 show waveforms with the low-pass filter circuit in operation.

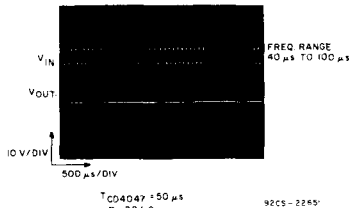

Fig. 28 - Low-pass filter-circuit waveforms.

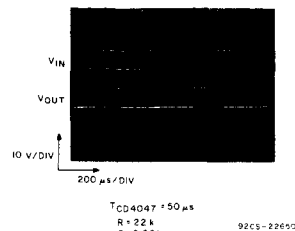

Fig. 29 - Low-pass-circuit waveforms.

### BANDPASS FILTER

Two CD4047A low-pass filters can be employed to construct a bandpass filter, as illustrated by the circuit in Fig. 30. The pass band is determined by the time constants of the two filters. If the output of filter No. 2 is delayed by  $C_1$ , the CD4013A flip-flop will clock high only when the cutoff frequency of filter No. 2 has been exceeded; this point is illustrated in the timing diagram in Fig. 30. The Q output of the CD4013A is gated with the output of filter No. 1 to produce

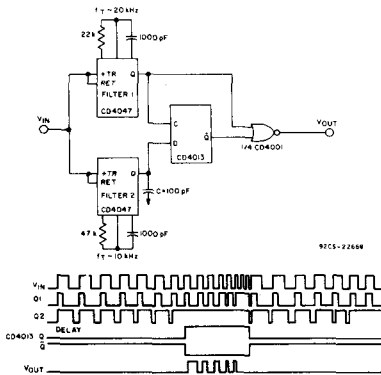

Fig. 30 - Bandpass filter circuit and waveforms.

the desired output. Typical operation of the circuit is shown in Fig. 31, where the input frequency is swept through the pass band.

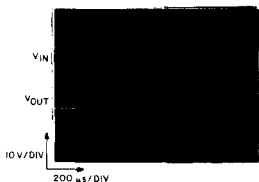

Fig. 31 - Bandpass-filter-circuit waveforms.

### ENVELOPE DETECTOR

The CD4047A can be used as an envelope detector by employing it in the retrigger mode, as shown in Fig. 32. The time constant is selected so that the circuit will retrigger at the



Fig. 32 - Envelope-detector circuit.

frequency of the input pulse burst. A dc level appears at the output for the duration of the input pulse train. Fig. 33 shows waveforms taken with the circuit in operation.

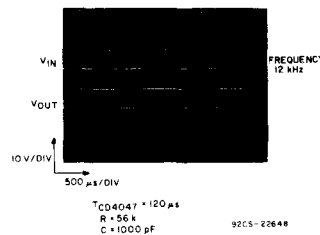

Fig. 33 - Envelope-detector-circuit waveforms.

### PULSE GENERATOR

Several CD4047A units can be connected together to produce a general-purpose laboratory pulse generator, as shown in Fig. 34. The circuit shown has variable-frequency and pulse-width control, as well as gating and delayed sync capability. Gating can be controlled from a high- or low-level input. Automatic 50-per-cent duty-cycle capability is included, as normal or inverted output.

CD4047A No. 1 is connected as a gated, astable multivibrator, and, with the RC values shown, can produce overlapping ranges of frequencies from 2 Hz to 1 MHz. For free-running operation, the Gate/Free-Run switch is closed, and the Gate Level switch is placed in the high-level position. Standby operation can be achieved with the Gate Level switch in the low-level position. When gating, the Gate/Free-Run switch is open, and the Gate Level switch is set to the appropriate position. The gate signal is applied to the Gate In jack.

CD4047A No. 2 is triggered from the gated, astable multivibrator, and produces a narrow sync pulse which can trigger an oscilloscope or generator. The sync pulse is obtained from the Sync Out jack.

If a 50-per-cent duty cycle is desired, the Duty Cycle switch is set in the 50-per-cent position, and the output is obtained from CD4047A No. 1. The Signal Polarity switch determines whether the Q and Q output is used.

CD4047A No. 3 produces a variable, delayed (from 1.5 microseconds to 250 milliseconds) output with respect to the sync pulse when the Delay switch is in the IN position. This one-shot is bypassed when the Delay switch is in the OUT position (the inherent delay is approximately 400 nanoseconds).

CD4047A No. 4 is a monostable multivibrator which receives trigger pulses from CD4047A No. 1 or No. 3. It can produce overlapping ranges of pulse widths from 1.5 microseconds to 200 milliseconds with the values shown.

The signal output is buffered with the CD4041A to allow the pulse generator to drive any required load. The circuit shown has the advantages of being compact, battery-powered, and COS/MOS compatible. In addition, it is capable of being run from the same power supply as the device under test to assure that the input levels are the same as  $V_{DD}$  when the power-supply voltage is varied.

### MISCELLANEOUS APPLICATIONS

The basic properties of good stability in the astable mode, and stable pulse delay and width control in the monostable mode, make the CD4047A a useful building block in many systems, such as PMOS clock generation, audio tone gener-

# ICAN-6230

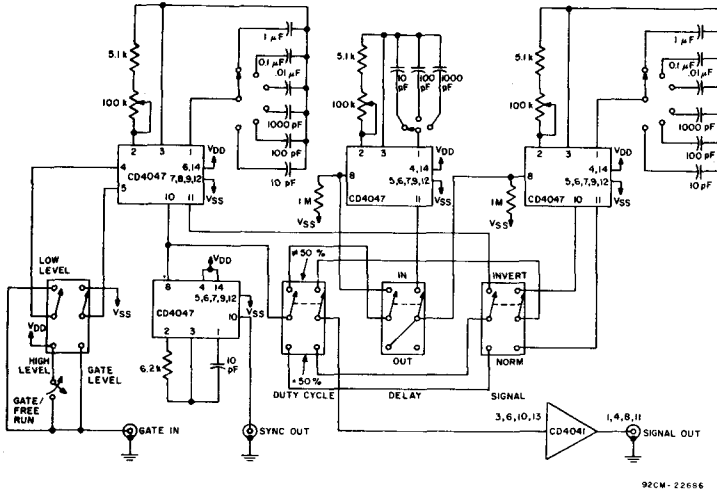

Fig. 34 - Pulse-generator circuit.

afion, semiconductor memory systems, semiconductor memory exercisers, and general-purpose functional-testing systems. This Application Note will serve as a guideline in incorporating the CD4047A in a system design.

## REFERENCES

1. "CD4047A COS/MOS Low-Power Monostable/Astable Multivibrator," RCA Data Bulletin, File No. 623
2. "Astable and Monostable Oscillators Using RCA COS/MOS Digital Integrated Circuits," by J. A. Dean and J. P. Rupley, RCA Application Note ICAN-6267

## ACKNOWLEDGMENTS

The assistance of R. Vaccarella in the designing of some of the application circuits shown and in obtaining laboratory measurements used in plotting the curves shown in this Note is acknowledged.

## Appendix A -

### Calculation of the Period of an Astable Multivibrator Using a Single RC Time Constant

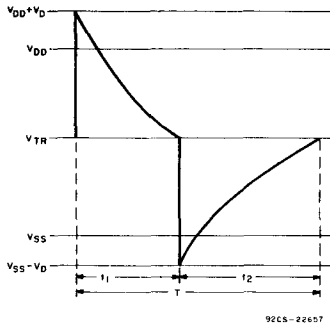

Fig. A-1 - RC oscillator waveform for the circuit of Fig. 1.

In Fig. A-1:

$$t_1: V_{TR} = (V_{DD} + V_D) e^{-t_1/RC}$$

$$t_1 = -RC \ln \frac{V_{TR}}{V_{DD} + V_D}$$

$$t_2: V_{DD} - V_{TR} = (V_{DD} + V_D) e^{-t_2/RC}$$

$$t_2 = RC \ln \frac{V_{DD} - V_{TR}}{V_{DD} + V_D}$$

And the period of an astable multivibrator using a single RC time constant is:

$$T = t_1 + t_2 = -RC \ln \frac{(V_{TR})(V_{DD} - V_{TR})}{(V_{DD} + V_D)^2}$$

## Appendix B -

### Analysis of Circuit Shown in Fig. 4

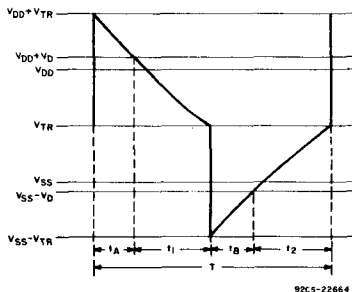

Fig. B-1 - RC waveform for the circuit of Fig. 4.

In Fig. B-1:

$$t_1: V_{TR} = (V_{DD} + V_D) e^{-t_1/RC}$$

$$t_1 = -RC \ln \frac{V_{TR}}{V_{DD} + V_D}$$

$$t_2: V_{DD} - V_{TR} = (V_{DD} + V_D) e^{-t_2/RC}$$

$$t_2 = -RC \ln \frac{V_{DD} - V_{TR}}{V_{DD} + V_D}$$

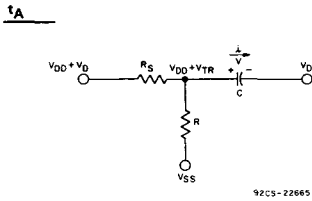

Fig. B-2 - Initial conditions for solving period  $t_A$ .

Circuit initial conditions are shown in Fig. B-2. In the figure

$$-C \frac{dv}{dt} = \frac{V + V_{DD}}{R} + \frac{V + V_{DD} - (V_{DD} + V_D)}{R_S} \quad (B-1)$$

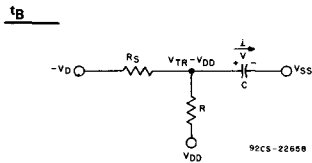

Fig. B-3 - Initial conditions for solving period  $t_B$ .

Circuit initial conditions as shown in Fig. B-3. In the figure

$$C \frac{dv}{dt} = \frac{V_{DD} - V}{R} - \frac{V_D + V}{R_S} \quad (B-3)$$

Solving Eq. (B-3) for V the final voltage across the capacitor, yields

$$V = C_2 e^{-K_1 t_B} - \frac{K_2}{K_1} \quad (B-4)$$

where  $C_2 = V_{TR} - V_{DD}$  = initial voltage across capacitor  
 $K_1, K_2$  are same values as for above for  $t_A$ .

Eq. (B-1) is solved for V; the final voltage across the capacitor is

$$V = C_1 e^{-K_1 t_A} + \frac{K_2}{K_1} \quad (B-2)$$

where  $C_1 = V_{TR}$  = initial voltage across capacitor

$$K_1 = \frac{R_S + R}{R_S R C}$$

$$K_2 = \frac{V_D R - R_S V_{DD}}{R_S R C}$$

By inserting these values into Eq. (B-2) and setting the final voltage across the capacitor, V, to  $V_D$ ,  $t_A$  becomes

$$t_A = - \left[ \frac{R_S R C}{R_S + R} \right] \ln \frac{R_S [V_{DD} + V_D]}{R_S [V_{DD} + V_{TR}] + R [V_{TR} - V_D]}$$

Insertion of these values into Eq. (B-4), with  $V = -V_D$  yields

$$t_B = - \left[ \frac{R_S R C}{R_S + R} \right] \ln \frac{R_S [V_{DD} + V_D]}{R_S [2 V_{DD} - V_{TR}] + R [V_{DD} - V_{TR} - V_D]}$$

and  $T = t_1 + t_2 + t_A + t_B$

The equations for  $t_A, t_B$ , and T can be simplified by expressing  $R_S$  as a multiple of R. Let

$K = \frac{R_S}{R}$  and combining the expressions for  $t_1$  and  $t_2$ . The resulting expression for T is

$$T = -RC \ln \frac{(V_{TR})(V_{DD} - V_{TR})}{(V_{DD} + V_D)^2}$$

$$- \left( \frac{K}{K+1} \right) RC \ln \frac{K [V_{DD} + V_D]}{K [V_{DD} + V_{TR}] + [V_{TR} - V_D]}$$

$$- \left( \frac{K}{K+1} \right) RC \ln \frac{K [V_{DD} + V_D]}{K [2 V_{DD} - V_{TR}] + [V_{DD} - V_{TR} - V_D]}$$

Appendix C -

Calculation for Period of Astable Multivibrator Using Integrated Techniques

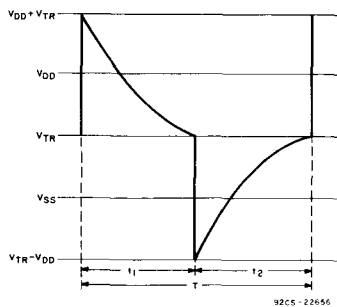

Fig. C-1 - CD4047A RC oscillator waveform.

In Fig. C-1

$$t_1: V_{TR} = (V_{DD} + V_{TR}) e^{-t_1/RC}$$

$$t_1 = RC \ln \frac{V_{TR}}{V_{DD} + V_{TR}}$$

$$t_2: V_{DD} - V_{TR} = (2 V_{DD} - V_{TR}) e^{-t_2/RC}$$

$$t_2 = -RC \ln \frac{V_{DD} - V_{TR}}{2 V_{DD} - V_{TR}}$$

And the period of the astable multivibrator using integrated techniques is

$$T = -RC \ln \frac{(V_{TR})(V_{DD} - V_{TR})}{(V_{DD} + V_{TR})(2 V_{DD} - V_{TR})}$$

Appendix D -

Power Needed for Charge and Discharge of an External Capacitor During One Cycle

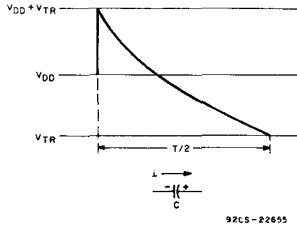

Fig. D-1 - Waveform for calculating power dissipation.

Assume for this calculation that  $V_{TR} = 50\text{-per-cent } V_{DD}$ , and that  $T = 2.2 RC$ . Since charge and discharge cycles are symmetrical, the calculation can be performed by analyzing a discharge cycle only. See Fig. D-1.

$$V = 1.5 V_{DD} e^{-t/RC}$$

$$\frac{dv}{dt} = - \left( \frac{1}{RC} \right) (1.5 V_{DD}) (e^{-t/RC})$$

$$P = \frac{1}{(T/2)} \int_0^{T/2} CV \frac{dv}{dt} dt$$

$$= \frac{2C}{T} \int_0^{T/2} (1.5 V_{DD} e^{-t/RC}) \left( \frac{1}{RC} \right) (1.5 V_{DD}) e^{-t/RC} dt$$

$$= \frac{4.5C}{T} \frac{V_{DD}^2}{RC} \int_0^{T/2} e^{-2t/RC} dt$$

$$= - \frac{2.25C}{T} V_{DD}^2 e^{-2t/RC} \Big|_0^{T/2}$$

Substituting  $T = 2.2 RC$

$$P = - \frac{C}{T} (2.25) V_{DD}^2 [e^{-2.2} - 1] = \frac{2.0C}{T} V_{DD}^2$$

$$P = 2 CV^2f$$

Appendix E -

Equations for Pulse Width  $T_M$  of CD4047A in Monostable Mode

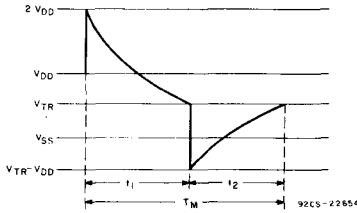

Fig. E-1 - CD4047A RC waveform, monostable mode.

Note that the waveform in Fig. E-1 is not symmetrical because the timing capacitor is initially charged to  $V_{DD}$ . In the monostable mode, the circuit goes through one cycle only.

Monostable Power Dissipation

To calculate the power dissipation for the circuit in the monostable mode, refer to Fig. E-1. If it is assumed that  $V_{TR} = 50\text{-per-cent } V_{DD}$ , Fig. 14 shows that  $T_M = 2.485 RC$ .  $t_2$  is the same as in the astable calculation, i.e.,  $t_2 = 1.10 RC$  and  $P_{t2} = CV^2f$  for  $V_{TR} = 50\text{-per-cent } V_{DD}$ . Thus,  $t_1$  in the monostable mode =  $2.485 RC - 1.10 RC = 1.385 RC$ .

$$P = \frac{1}{T_M} \left[ \int_0^{t_1} CV \frac{dv}{dt} dt + \int_{t_1}^{t_2} CV \frac{dv}{dt} dt \right]$$

$$= \frac{1}{T_M} \int_0^{t_1} CV \frac{dv}{dt} dt + \frac{1}{T_M} CV^2$$

where  $V = 2 V_{DD} e^{-t/RC}$  and

$$\frac{dv}{dt} = - \left( \frac{1}{RC} \right) (2 V_{DD}) e^{-t/RC}$$

$$t_1: V_{TR} = 2 V_{DD} e^{-t_1/RC}$$

$$t_1 = -RC \ln \frac{V_{TR}}{2 V_{DD}}$$

$$t_2: V_{DD} - V_{TR} = (2 V_{DD} - V_{TR}) e^{-t_2/RC}$$

$$t_2 = -RC \ln \frac{V_{DD} - V_{TR}}{2 V_{DD} - V_{TR}}$$

And the equation for the pulse width,  $T_M$ , of a CD4047A in the monostable mode is:

$$T_M = t_1 + t_2 = -RC \ln \frac{(V_{TR})(V_{DD} - V_{TR})}{(2 V_{DD})(2 V_{DD} - V_{TR})}$$

$$P_{t1} = \frac{C}{T_M} \int_0^{t_1} (2 V_{dd} e^{-t/RC}) \left( \frac{1}{RC} \right) (2 V_{dd} e^{-t/RC}) dt$$

$$= \frac{C}{T_M} \frac{4 V_{dd}^2}{RC} \int_0^{t_1} e^{-2t/RC} dt$$

$$= - \frac{C}{T_M} 2 V_{dd}^2 e^{-2t/RC} \Big|_0^{t_1}$$

Substituting  $t_1 = 1.385 RC$

$$P_{t1} = - \frac{C}{T_M} 2 V_{dd}^2 [e^{-2.77} - 1] = \frac{1.875 C V_{dd}^2}{T_M}$$

$$P = P_{t1} + P_{t2} = (1.875 + 1) \frac{C V_{dd}^2}{T_M} = 2.875 \frac{C V_{dd}^2}{T_M}$$

For a repetitive output from the CD4047A

$$P = \frac{2.875 C V_{dd}^2}{T_M} \times \text{duty cycle}$$

# COS/MOS Interfacing Simplified

by D. Blandford and A. Bishop

COS/MOS with its wide range of operating supply voltages, low input current, and low power consumption, interfaces easily with many electronic devices. In addition, COS/MOS circuitry can easily be added to a system and can often be operated from the existing power supply. Examples of practical circuits for a wide variety of interfacing situations are given in this Note; design constraints are included in each case.

Note that the CD4000 Series type numbers are followed by a suffix letter, A or B, which specifies the maximum operating voltage for the device: A, 3 to 15 volts; B, 3 to 18 volts. The outputs of all B-type devices are buffered and have the same output drive current and equal source and sink capabilities. Table I shows some characteristics of B-type devices.

essentially "capacitive", which means that many COS/MOS inputs may be driven by a single TTL output. The actual number depends on the frequency of operation.

In the COS/MOS to TTL interface, Fig. 3, the requirement is to sink sufficient current in the low output state at a maximum output voltage of 0.4 volt. Table III gives the current sinking capability of some CD4000-series devices. Note that all B-type devices have the same standard output drive and are capable of sinking two low-power TTL loads, worst case. For the higher power types of TTL, the CD4049A and CD4050A buffers may be used. Table IV shows the minimum and typical fanout for each TTL family. The buffer takes its power from the 5-volt TTL supply and has an additional advantage in that

Table IV—Fanout of CD4049A and CD4050A Buffers to TTL

Buffer Fanout	TTL Family				
	74	74H	74L	74LS	74S
Minimum	1	1	14	7	1
Typical	3	2	28	14	2

Table I—Output Drive Current—B-Type Devices

Output Drive Current	Symbol	V <sub>DD</sub> Volt	BD, BK, BF, BH					BE			Units
			V <sub>O</sub> Volt	-55°C Min.	+25°C Min.	+125°C Min.	-40°C Min.	+25°C Min.	+85°C Min.	+25°C Typ.	
Sink	I <sub>DN</sub>	5	0.4	0.5	0.4	0.3	0.45	0.4	0.36	0.8	mA
		10	0.5	1.1	0.9	0.65	1.0	0.9	0.75	1.8	mA
Source	I <sub>DP</sub>	5	4.6	-0.5	-0.4	-0.3	-0.45	-0.4	-0.36	-0.8	mA
		10	5	2.5	-2.0	-1.6	-1.15	-1.8	-1.6	-1.3	-3.2
		10	9.5	-1.1	-0.9	-0.65	-1.0	-0.9	-0.75	-1.8	mA

## COS/MOS to TTL

In interfacing TTL with COS/MOS with a common power supply of between 4.5 and 5.5 volts, the guaranteed active-pull-up TTL output voltage of 2.4 volts is lower than the minimum COS/MOS input voltage required to guarantee switching, 3.5 volts, Fig. 1. This difference is overcome by the use of an external resistor, R<sub>X</sub> in Fig. 2, which is also the resistor to be used for open-collector-output TTL at a V<sub>DD</sub> of 5 volts. The minimum value of R<sub>X</sub> is fixed by the maximum sink current, e.g., 1.6 milliamperes for 74-series TTL, its maximum value by I<sub>OH</sub>, the off leakage of the output sink transistor. As shown in Table II, the values of R<sub>X</sub> between 1.5 and 4.7 kilohms are suitable for all the TTL families under worst-case conditions. The COS/MOS input impedance is

it can accept input voltage swings of 5 to 15 volts from the preceding COS/MOS system.

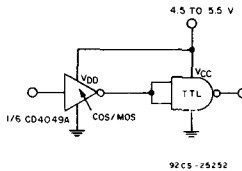

Fig. 3—COS/MOS to TTL interface.

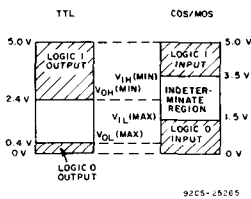

Fig. 1—TTL to COS/MOS voltage levels.

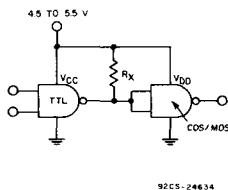

Fig. 2—TTL to COS/MOS interface.

Table II—Values of R<sub>X</sub> for TTL—COS/MOS Interface

Characteristic	74	74H	74L	74LS	74S
R <sub>X</sub> min. (ohms)	390	270	1.5k	820	270
R <sub>X</sub> max. (kilohms)	4.7	4.7	27	12	4.7

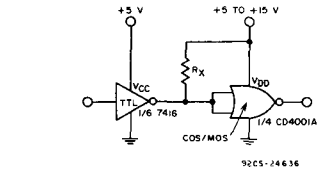

Fig. 4—TTL to COS/MOS at a V<sub>DD</sub> greater than 5 volts.

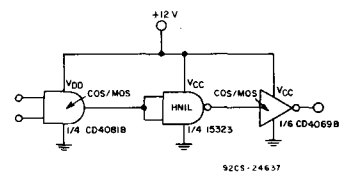

Fig. 5—COS/MOS to HN1L to COS/MOS interface.

## COS/MOS to DTL

The COS/MOS to DTL interface requires a buffer, such as the CD4049A shown in Fig. 6, to sink the DTL input current of 1.5 milliamperes at 0.4 volt. Fanout to DTL circuits depends on the sink-current capability of the COS/MOS buffer used. For the CD4049A and CD4050A, typical fanout is 3.

The DTL to COS/MOS interface requires no special consideration because the internal pull-up resistor in DTL circuits and the extremely low input current of COS/MOS circuits ensures a high logic level almost equal to the power-supply voltage.

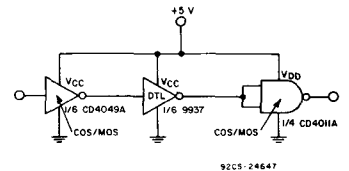

Fig. 6—COS/MOS to DTL to COS/MOS interface.

To gain improvements in speed and noise immunity in a system using a COS/MOS supply voltage greater than +5 volts, high-voltage open-collector TTL circuits such as the 7416, 7417 or 7426 may be used, as shown in Fig. 4. The value of the pull-up resistor R<sub>X</sub> will depend on the actual value of V<sub>DD</sub>; at 10 volts, 39 kilohms would be suitable.

## COS/MOS to HN1L

The wide operating-voltage range and low power consumption of COS/MOS circuitry enables it to operate from the HN1L power supply. Most CD4000A circuits will drive the HN1L input directly; for example, in Fig. 5, the CD4081B output sinks the required 1.4 milliamperes at an output voltage typically less than 0.5 volt. The HN1L output-voltage levels, 0.8 volt and 10 volts, enable it to interface directly with the COS/MOS input with good noise immunity.

Table III—Minimum Current-Sinking Capability of COS/MOS Devices

COS/MOS Type	Description	Sink Current (mA at 25°C V <sub>O</sub> = 0.4 Volt, V <sub>DD</sub> = 5 Volt)	
		Ceramic	Plastic
CD4000A	Dual 3-Input NOR Gate Plus Inverter	0.4	0.3
CD4001A	Quad 2-Input NOR Gate	0.4	0.3
CD4002A	Dual 4-Input NOR Gate	0.4	0.3
CD4007A	Dual Complementary Pair Plus Inverter	0.6	0.3
CD4009A/49A	Inverting Hex Buffer	3.0	3.0
CD4010A/50A	Non-Inverting Hex Buffer	3.0	3.0
CD4011A	Quad 2-Input NAND Gate	0.2	0.1
CD4012A	Dual 4-Input NAND Gate	0.1	0.05
CD4041A	Quad True/Complement Buffer	0.4	0.2
CD4031A	64-Stage Static Shift Register	1.3	1.3
CD4048A	Expandable 8-Input Gate	1.6	1.6
CD4XXXXB	Any B-Type Device Output	0.4	0.4

# ICAN-6315

## COS/MOS to 10k ECL

COS/MOS and 10k ECL are not normally interfaced, but they can be readily by using the 10124 and 10125 devices which are intended for conversion between ECL and TTL. This interface requires that the COS/MOS device be operated at a 5-volt  $V_{DD}$ , as shown in Fig. 7. Where greater speed is required of the COS/MOS system, it can be operated with  $V_{DD}$  at the ECL ground and  $V_{SS}$  at -12 volts. In the latter case, a 1N914 diode clamps the COS/MOS output to  $V_{EE}$  as shown in Fig. 8. At supply voltages greater than 6 volts, a COS/MOS buffer should not be used, as over-dissipation will occur in the buffer.

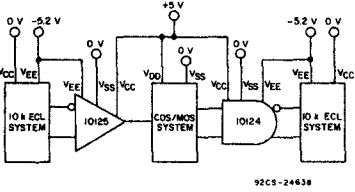

Fig. 7—10k ECL to COS/MOS and COS/MOS to 10k-ECL interface.

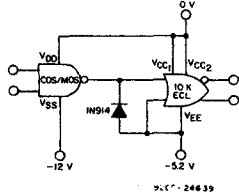

Fig. 8—COS/MOS at 12 volts to 10k-ECL interface.

## COS/MOS to NMOS

The increasing use of n-channel MOS memories means that interfaces between COS/MOS and NMOS are now common. In a system of 1k memories, such as the type 2102, which employ peripheral COS/MOS circuitry for address, read/write, chip select and data handling, the COS/MOS circuitry can be supplied from the 5-volt power supply of the memory. Inputs to the memory are then COS/MOS compatible, and direct interface is permitted. The data output requires only a single pull-up resistor,  $R_x$ , as shown in Fig. 9, to ensure an acceptable high-state output voltage.

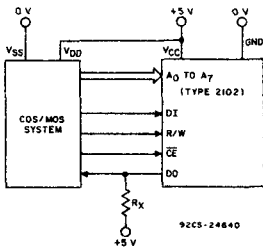

Fig. 9—Direct interface between COS/MOS and 1k memory, type 2102.

A 4k-bit, dynamic, n-channel RAM, such as the 2107A, has +12-volt and -5-volt supplies as well as the +5-volt  $V_{CC}$  supply, as shown in Fig. 10. The COS/MOS peripheral circuitry in this system is probably best operated from the +12-volt supply, ensuring good speed characteristics and noise immunity. The 5-volt input signals to the memory are provided by CD4050A buffers powered by the 5-volt  $V_{CC}$  supply. The 12-volt-swing chip-enable signal is directly compatible with the 12-volt COS/MOS system. The data output uses a single transistor to generate the required 12-volt logic swing; memories added to provide an increase in word capacity are wire-OR'ed at the data output pin of the memory.

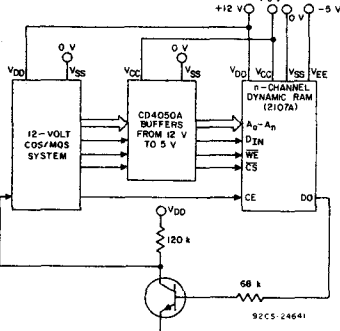

Fig. 10—COS/MOS to n-channel dynamic RAM interface.

## COS/MOS to PMOS

Silicon-gate PMOS static shift registers operating from +5-volt and -12-volt supplies are directly compatible with a COS/MOS system operating from the +5-volt supply with  $V_{SS}$  at zero volts. The only additional component required is a clamp diode to  $V_{SS}$  on the data output, as shown in Fig. 11, because the unloaded PMOS output voltage will go negative in the low output state.

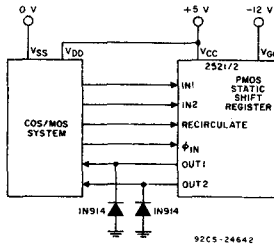

Fig. 11—COS/MOS to PMOS static shift-register interface.

## COS/MOS to Industrial and Power-Control Circuits

Industrial control systems employ greater logic swings than IC logic systems, such as COS/MOS, to achieve high noise immunity and to enable them to operate from readily available high-voltage supplies and to interface with electro-mechanical equipment.

Fig. 12 shows a simple, resistive-divider circuit used to interface a system with a 24-volt logic swing to COS/MOS; the circuit could readily be modified for even higher voltage swings. The capacitor filter enhances the excellent noise

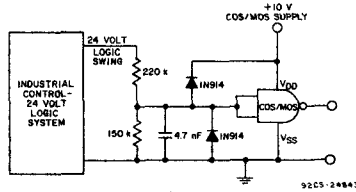

Fig. 12—Industrial control to COS/MOS interface.

immunity of the COS/MOS logic, and the two clamp diodes ensure that the input signal voltage is between  $V_{DD}$  and  $V_{SS}$ . An alternative circuit using a zener diode is shown in Fig. 13.

A single-transistor level-converter interfaces a COS/MOS device to an industrial control system, as shown in Fig. 14. The transistor is driven directly from the COS/MOS device output (Fig. 23 describes the method of calculating the values of the resistors needed in Fig. 14).

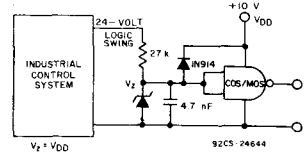

Fig. 13—Zener diode industrial control interface.

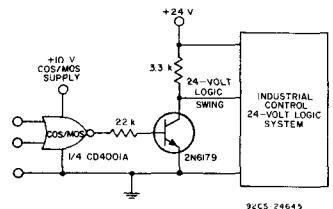

Fig. 14—COS/MOS to industrial-control interface.

The slow pulse edges typically found in an industrial control system can be speeded up in the COS/MOS system by a Schmitt-trigger circuit, the CD4093B, Fig. 15(a). At a  $V_{DD}$  of 5 volts,  $V_{IH}$  is typically 0.6 volt, Fig. 15(b).

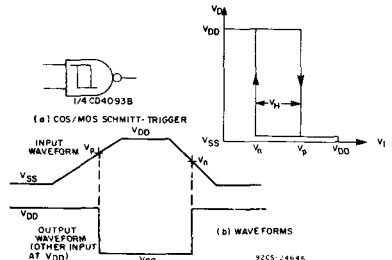

Fig. 15—(a) COS/MOS Schmitt-trigger, (b) typical waveforms for Schmitt-trigger.

A high-power coil, such as the solenoid of a printer hammer, which requires about 1 ampere at 70 volts, may be driven from a COS/MOS system by using a Darlington transistor as shown in Fig. 16. A typical value of  $V_{BE}$  for a type 2N6385 transistor is 1.5 volts at a collector current of 1 ampere and a minimum gain of 1000, so that the output source transistor of the CD4073B has to supply 1.5 milliamperes. The value of resistor R is chosen so that  $V_{DS}$  is sufficient to guarantee this output current. Suitable values of R for use with a B-type device are given in Fig. 16 for a  $V_{DD}$  of 5, 10, and 15 volts.

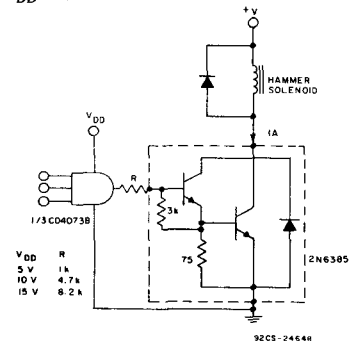

Fig. 16—COS/MOS system driving a printer-hammer solenoid with the aid of a Darlington transistor.



Power-control SCR's and triacs may also be driven directly by COS/MOS outputs. A sensitive-gate SCR, such as the 106B1, may be controlled directly by a COS/MOS gate, such as the CD4069B, and thus be able to control directly 2.5 amperes at reverse voltages up to 600 volts, as shown in Fig. 17.

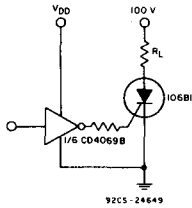

Fig. 17—COS/MOS directly driving a sensitive-gate SCR.

SCR's and triacs with gate currents in the milliampere region may be controlled by a buffer, such as the CD4049A. This buffer could, in turn, be controlled by a COS/MOS system or, as in Fig. 18, by an opto-coupler to provide greater isolation.

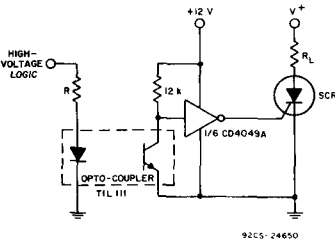

Fig. 18—High-voltage logic to COS/MOS driving an SCR.

In cases where a single-gate output source or sink current proves insufficient, it is possible to parallel the inputs and outputs of gates on the same chip, as in Fig. 19. Gates not on the same chip and buffer circuits should not be operated in parallel as over-dissipation may result.

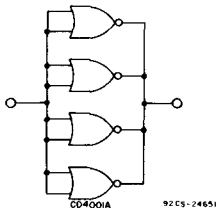

Fig. 19—Paralleling inputs and outputs.

**Interfacing Op-Amps to COS/MOS**

COS/MOS circuits may be connected directly to the output of an op-amp operating between the normal  $\pm 15$ -volt supply rails, as in Fig. 20, provided clamp diodes to  $V_{DD}$  and  $V_{SS}$  are used to ensure that the COS/MOS input voltage does not go outside the range  $V_{SS}$  to  $V_{DD}$ . Resistor R3 should limit the op-amp output current should the op-amp output voltage tend toward the negative rail.

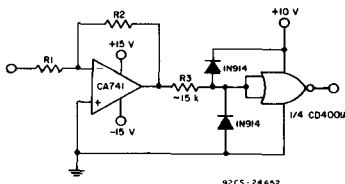

Fig. 20—Split-rail op-amp to COS/MOS interface.

Fig. 21 shows a CA741-type op-amp operated between  $V_{DD}$  and  $V_{SS}$  with a resistive divider on the non-inverting op-amp input.

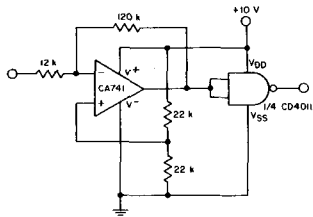

Fig. 21—Interface of op-amp and COS/MOS with common supply rail.

**COS/MOS Driving Displays**

Digital systems now employ a great variety of digital displays, so that their interface to COS/MOS is a common requirement.

**COS/MOS TO LED'S**

LED's may be driven directly from a COS/MOS buffer, such as the CD4050A shown in Fig. 22, at a drive current of 15 milliamperes if a power supply of approximately 10 volts is available.

Seven-segment LED displays connected in either common anode or common cathode configurations may be driven at supply voltages as low as +5 volts by the seven-transistor

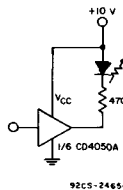

Fig. 22—COS/MOS buffer driving an LED.

arrays CA3081 and CA3082. Fig. 23 shows one of the seven transistors of the CA3081 with an LED load. The figure also shows the method of calculating  $R_b$  and  $R_c$ . The base drive current available depends on the CD4000A Series device used and the values of  $V_{DD}$  and  $V_{DS}$ . As shown in Fig. 24, the base drive current increases with both  $V_{DD}$  and  $V_{DS}$ . Fig. 25 shows one of the seven transistors of the CA3082 driving a common-cathode LED. The method of calculating the value of emitter resistor  $R_e$  is also shown in Fig. 25.

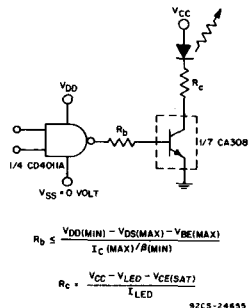

Fig. 23—COS/MOS driving a transistor that has an LED load.

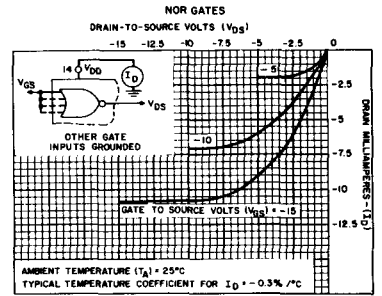

Fig. 24—CD4001A—typical p-channel drain characteristics.

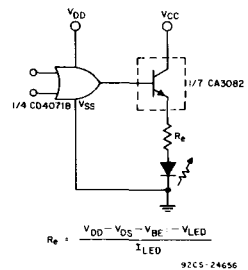

Fig. 25—COS/MOS driving a transistor with a common-cathode connected LED load.

**COS/MOS TO LCD**

Seven-segment liquid-crystal displays may be driven directly by COS/MOS circuits CD4054A, CD4055A or CD4056A, as shown in Fig. 26. These circuits contain the internal level-shifting circuitry needed to convert the typically 5-volt input logic-level swing to the 30-volt peak ac signal required to drive the dynamic-scattering LCD.

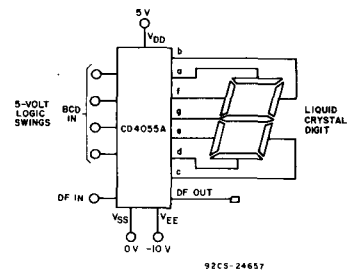

Fig. 26—Using the CD4055A to drive a liquid crystal.

**COS/MOS TO GAS-DISCHARGE DISPLAY**

The popular seven-segment gas-discharge display requires a cathode drive current that varies from segment to segment. Manufacturers supply drivers which are COS/MOS compatible at their inputs so that they can interface a COS/MOS system to the gas-discharge display without additional circuitry.

**REFERENCE**

1. "COS/MOS Digital Integrated Circuits", RCA DATABOOK Series SSD-203B, 1975.

# ICAN-6346

## Applications of the RCA-CD4093B COS/MOS Schmitt Trigger

by D. J. Blandford

This Note describes the characteristics and some typical applications of the CD4093B COS/MOS quad two-input NAND Schmitt Trigger. The CD4093B may be used in all applications in which the logical NAND function is required and, in addition, in a whole range of timing, waveshaping, and interfacing applications in which the Schmitt Trigger action on the inputs is utilized.

### CHARACTERISTICS

The CD4093B consists of four Schmitt triggers in a fourteen-pin package. Each of the four devices is a two-input NAND gate with Schmitt action on each input, yielding a typical hysteresis voltage of 2.0 volts with a 10-volt supply without the need for any external components. In addition, the CD4093B is compatible, pin for pin, with the popular CD4011A quad NAND gate, has the balanced and standardized output drive of the 18-volt COS/MOS "B" series types, and has low propagation delay and very low power dissipation. Table I summarizes these characteristics.

If now the input voltage is reduced, the output stays low ( $V_{SS}$ ) until  $V_n$  is reached. At this point the output goes high ( $V_{DD}$ ) and remains high as the input voltage is reduced to zero ( $V_{SS}$ ). The hysteresis voltage is the difference between  $V_p$  and  $V_n$  and is typically 0.6 volt for a 5-volt  $V_{DD}$  and 2.0 volts for a 10-volt  $V_{DD}$ .

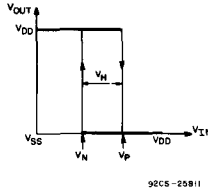

Fig. 2 - Transfer characteristic of the CD4093B.

TABLE I

Static and Dynamic Electrical Characteristics at 25°C

CHARACTERISTIC	SYMBOL	$V_0$ VOLTS	$V_{DD}$ VOLTS	TYPICAL VALUES	UNITS
QUIESCENT DEVICE CURRENT	$I_L$	5	5	0.001	$\mu A$
		10	10	0.001	$\mu A$
OUTPUT VOLTAGE LOW LEVEL	$V_{OL}$	5	5	0	V
		10	10	0	V
HIGH LEVEL	$V_{OH}$	5	5	5	V
		10	10	10	V
NOISE IMMUNITY	$V_{NL}$	5	5	2.6	V
		10	10	5.2	V
	$V_{NH}$	0	5	3.0	V
		0	10	6.5	V
OUTPUT DRIVE CURRENT SINK	$I_{DN}$	0.4	5	0.8	mA
		0.5	10	1.8	mA
	SOURCE	4.6	5	-0.8	mA
		2.5	5	-1.8	mA
POSITIVE THRESHOLD VOLTAGE	$V_p$	5	5	2.6	V
		10	10	5.2	V
NEGATIVE THRESHOLD VOLTAGE	$V_n$	5	5	2.0	V
		10	10	3.5	V
HYSTERESIS VOLTAGE	$V_h$	5	5	0.6	V
		10	10	1.7	V
PROPAGATION DELAY TIME $C_L = 50$ pF	$t_{PHL}$	5	5	190	ns
	$t_{PLH}$	10	10	100	ns
TRANSITION TIME $C_L = 50$ pF	$t_{TLH}$	5	5	100	ns
	$t_{THL}$	10	10	50	ns

Fig. 1 shows the functional diagram of the Schmitt trigger; note that each input has the standard COS/MOS input protection network and that each output is double buffered.

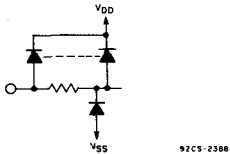
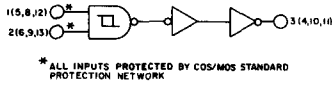

Fig. 1 - Functional diagram of the CD4093B COS/MOS Schmitt trigger. One of four Schmitt triggers is shown.

Fig. 2 shows the transfer characteristic of the Schmitt trigger. The general shape of this characteristic is the same for all values of  $V_{DD}$ , but the relative values of  $V_p$ ,  $V_n$  and  $V_h$  change with  $V_{DD}$  as shown in the data sheet. As the input voltage is increased from zero ( $V_{SS}$ ), the output remains high ( $V_{DD}$ ) until  $V_p$  is reached. At this point the output goes low ( $V_{SS}$ ) and remains low as the input voltage is raised to  $V_{DD}$ .

Fig. 3 shows a graph of the typical hysteresis voltage  $V_h$  as a function of supply voltage  $V_{DD}$ .

Fig. 4 shows the input/output characteristics of the CD4093B; the output characteristic shown is the same for any COS/MOS output, including the Schmitt trigger. The input characteristic is unique to the Schmitt trigger. The input characteristic is unique to the Schmitt device, the Schmitt trigger has more than 50-percent noise immunity in each state.

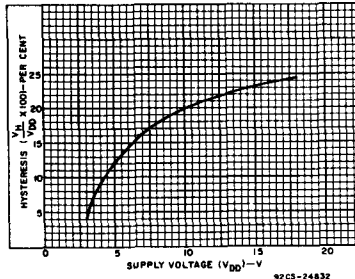

Fig. 3 - Typical percent hysteresis vs supply voltage.

Figs. 5 and 6 show measurements of voltage and energy noise immunity for the Schmitt trigger. Fig. 5 shows, for example, that for a  $V_{DD}$  of 5 volts, the noise immunity in each

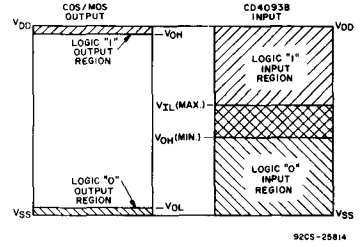

Fig. 4 - Input and output characteristics.

state exceeds the supply voltage (5 volts) for pulses shorter than 200 nanoseconds. The energy noise immunity plotted in Fig. 6 against pulse width is the product of noise-pulse voltage, noise-pulse time, and the appropriate value of the output drive current for the device under test. The units of energy are nanojoules ( $10^{-9}$  Joule). At each value of the supply voltage the curve has a minimum value. Inspection of Fig. 6 shows that the value of the minimum energy noise immunity increases with increasing  $V_{DD}$ , and occurs at a lower value of noise-pulse width.

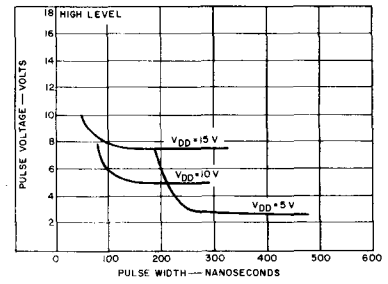
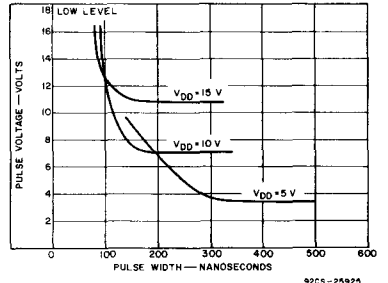
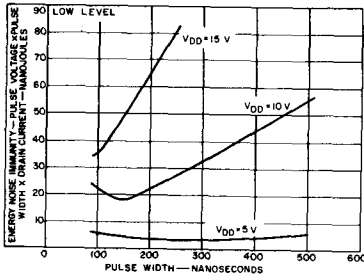

Fig. 5 - Voltage noise immunity of the CD4093B.

Another important property of the Schmitt trigger is illustrated in Fig. 7, which compares the supply current taken by the CD4093B with that of the CD4011A, with a long rise- and fall-time input. The power dissipated by the Schmitt trigger is clearly much less than that dissipated by the quad NAND gate, so that the Schmitt trigger should be used in applications in which slow input edges are anticipated.

### APPLICATIONS

The application of the CD4093B COS/MOS Schmitt trigger in situations which require the logical NAND function and in timing, waveshaping, and interfacing applications in which the Schmitt trigger action on the inputs is utilized are discussed below.



92CS-25927

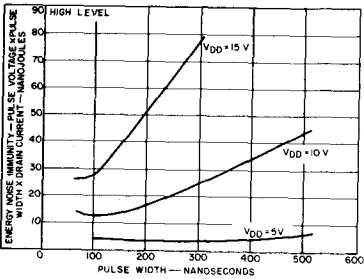

92CS-25928

Fig.6 - Energy noise immunity of the CD4093B.

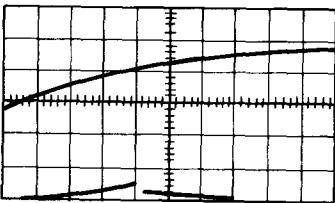

(a) CD4093BE:  
Top vertical - 5V/Division  
Lower vertical - 2mA/Division  
Horizontal - 0.2/Division

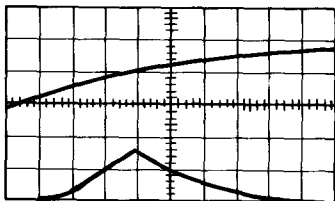

(b) CD4011AE:  
Top vertical - 5V/Division  
Lower vertical - 2mA/Division  
Horizontal - 200ms/Division

92CS-26636

Fig.7 - Power consumption with slow input edge, a comparison of the CD4093B with the CD4011A.

**Waveshaping**

**Sine Wave to Square-Wave Converter** - Fig.8 shows a typical application of the Schmitt trigger, the sine-wave to square-wave converter. The sine input is ac coupled by capacitor

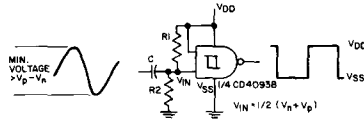
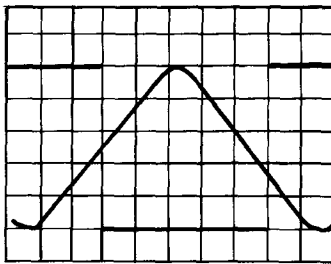

Fig.8 - Sine-wave to square-wave converter.

C; R1 and R2 bias the input midway between Vn and Vp, the input threshold voltages, to provide a square wave at the output.

**Slow Edges** - Slow edges are a common phenomenon in digital systems; for example, at the output from a transducer, at the end of a long line, or an output with large capacitive load, or on the output of a filter. The Schmitt trigger is particularly useful in generating a waveform with fast edges in these applications, see Fig.9.



CD4093BE:

2V/Division

2ms/Division

92CS-26635

Fig.9 - Sharpening up a slow edge.

With an input edge time of 1 second and an output transition time of 100 nanoseconds, the improvement in edge time is a factor of 10<sup>7</sup>. With longer input edge times the improvement is even greater.

**Timing** - In general, timing circuits use external resistors and capacitors to provide time constants. The advantage of the CD4093B COS/MOS Schmitt trigger in these applications is that the very high input impedance permits the designer to use high values of timing resistance. Therefore, long delay times may be produced with moderate values of capacitance, and small, low-cost capacitors may be used for short and medium time delays.

**Edge Delays** - In the circuit of Fig.10, the output falling edge is delayed with respect to the input leading edge by a time td<sub>+</sub>, given by:

$$td_+ = RC \ln \frac{V_{DD}}{V_{DD} - V_p}$$

When the input goes high (VDD) the capacitor charges up towards VDD through R. When input B reaches Vp, the output goes low (VSS). As soon as input A goes low, the output goes high.

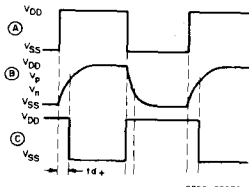
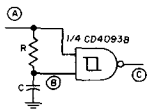

92CS-25930

Fig.10 - Delay on leading edge.

By connecting one input to VDD, as in Fig.11, both edges are delayed, because now, when input A goes low, output C remains low until capacitor C discharges to Vn. At this time, the output goes high. td<sub>-</sub> is given by:

$$td_- = RC \ln \frac{V_{DD}}{V_n}$$

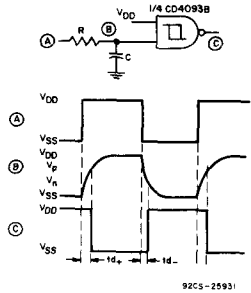

92CS-25931

Fig.11 - Delayed pulse.

Both edges may be separately delayed by connecting different RC timing components to each input, as in Fig.12. Now td<sub>+</sub> and td<sub>-</sub> are given by:

$$td_+ = R_2 C_2 \ln \frac{V_{DD}}{V_{DD} - V_p}$$

$$td_- = R_1 C_1 \ln \frac{V_{DD}}{V_n}$$

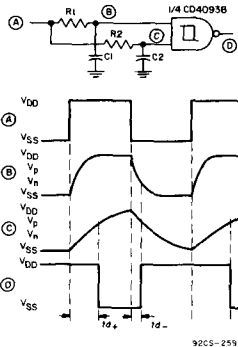

92CS-25932

Fig.12 - Separate delay to each edge.

**Edge Detector** - Fig.13 shows a circuit that provides a short negative-going output pulse for every positive-going edge at the input. The input waveform is coupled to the input by capacitor C; the pulse length depends, as before, on R and C. If a negative going edge detector is required, the circuit of Fig.14 should be used.

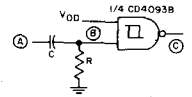

92CS-25933

Fig.13 - Rising-edge detector.

# ICAN-6346

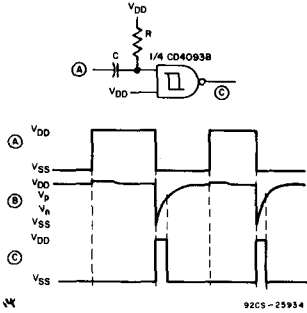

Fig. 14 - Falling-edge detector.

### Power-On Reset

A reset pulse is often required at power-on in a digital logic system. This type of reset pulse is ideally provided by the circuit of Fig. 15(a). Because of the high input impedance of the Schmitt trigger, long reset pulse times may be achieved without the excess dissipation that results when both output devices are on simultaneously, as in an ordinary gate device, Fig. 15(b).

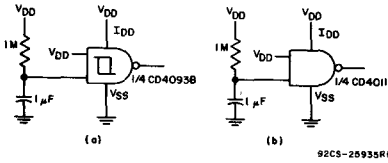

Fig. 15 - Reset circuit: a comparison of the CD4093B with the CD4011.

### Astable Oscillators

A range of astable oscillators may be easily constructed by using the CD4093B. Fig. 16 shows the basic circuit and its

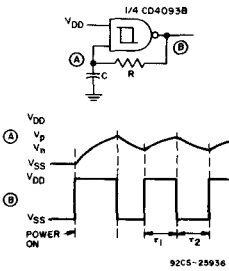

Fig. 16 - Astable multivibrator.

associated waveforms. Before power is applied, input and output are at ground potential and capacitor C is discharged. On power-on, the output goes high ( $V_{DD}$ ) and C charges through R until  $V_p$  is reached; the output then goes low ( $V_{SS}$ ). C is now discharged through R until  $V_n$  is reached. The output then goes high and charges C towards  $V_p$  through R. Thus input A alternately swings between  $V_p$  and  $V_n$  as the output goes high and low. One important advantage of this circuit is that the oscillator is self-starting at power-on.

The oscillator period is given by:

$$\tau = \tau_1 + \tau_2$$

where

$$\tau_1 = RC \ln \frac{V_{DD} - V_n}{V_{DD} - V_p}$$

and

$$\tau_2 = RC \ln \frac{V_p}{V_n}$$

In general  $\tau_1 \neq \tau_2$ , so that to get a 1:1 mark-to-space ratio the circuit of Fig. 17(a) should be used. When the output is low in the circuit of Fig. 17, C is discharged through  $R_1$  in parallel with  $R_2$ , which shortens  $\tau_2$ . If  $R_2$  is much smaller than  $R_1$ , short, negative-going pulses are produced, as in Fig. 17(b).

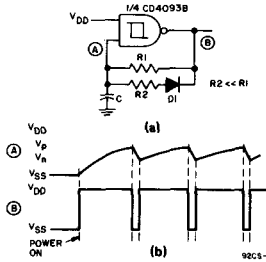

Fig. 17 - Astable oscillator with control'd mark-to-space ratio.

In the circuit of Fig. 18 the oscillator is gated by signal C on the second input of the CD4093B. The oscillator output is high while the gating signal is low; the oscillator then oscillates with the period  $\tau$ , given above, while the gating signal is high.

### Interfacing

The noise immunity of the COS/MOS NAND Schmitt trigger is very high, typically greater than 50 percent of  $V_{DD}$  in each state, as shown in Fig. 4. Therefore, it is ideally suited to circuitry that requires a very high noise immunity. Because of the hysteresis built into the Schmitt trigger, it can tolerate noise on a slow input edge without false switching at the output, as shown in Fig. 19. This noise performance permits the construction of an ideal interface from an industrial environment to a COS/MOS logic system, as shown in Fig. 20. The CD4093B will function correctly under the most severe conditions of input overvoltage and in spite of noise spikes of up to hundreds of volts. The input is kept between  $V_{SS}$  and  $V_{DD}$  by  $D_1$  and  $D_2$  with  $R_1$ , typically 220 kilohms, as a current-limiting resistor. Resistor  $R_2$  ties the logic input to

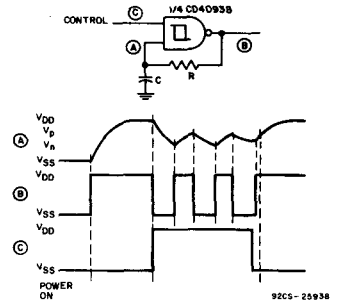

Fig. 18 - Gated astable oscillator.

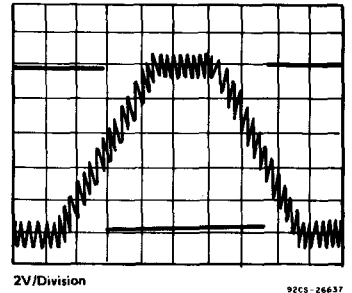

Fig. 19 - Rejection of noise on slow input edge.

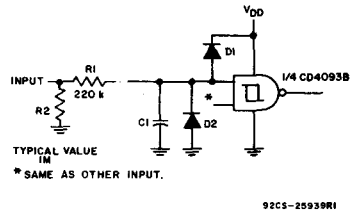

Fig. 20 - Industrial-environment to COS/MOS interface.

$V_{SS}$  should be the interface input be open-circuited by the removal of a PC board from a system, for example. Capacitor  $C_1$ , with  $R_1$ , acts as a filter and enhances the noise-rejection properties of the interface.

# Astable and Monostable Oscillators Using RCA COS/MOS Digital Integrated Circuits

by  
D. V. DiMassimo &  
A. R. Maslowski

## CIRCUIT TECHNIQUES

COS/MOS integrated logic circuits are being widely used in digital and other applications because of their high noise immunity, extremely low power dissipation, and tolerance to wide variations in power-supply voltages and operating temperatures. In addition, because their high input impedance makes it possible to obtain large time constants without the use of large capacitors, COS/MOS gates can provide cost and size reductions in multivibrator circuits.<sup>1</sup>

This Note describes several techniques that may be used to compensate for the normal threshold variation of MOS devices in the design of stable multivibrator circuits operating at frequencies up to 1 MHz. The circuits shown can be formed by the use of COS/MOS inverters or COS/MOS NAND or NOR gates connected in an inverter configuration. NAND and NOR gates perform the inverter function when all of the gate inputs are tied together. This Note also describes various applications for COS/MOS multivibrator circuits: voltage-controlled oscillators, voltage-controlled pulse-width circuits, phase-locked voltage-controlled oscillators, frequency multipliers, and modulator/demodulators (envelope detectors).

### Astable Circuits

The circuits shown in Fig. 1 are those of astable multivibrators that use two COS/MOS inverters (which may be taken from standard RCA COS/MOS parts such as the CD4069B, CD4007A, CD4001, or CD4011). Fig. 2 shows the related waveforms. This simple circuit requires only two resistors and one capacitor and operates in the following manner. Resistor  $R_S$ , connected in series with the input of the first inverter, limits the current through the input protection circuit, Fig. 3. In operation, the input to the first inverter is clamped at one diode drop above  $V_{DD}$  or one diode drop below  $V_{SS}$ . Depending on the output levels of the two inverters, at any instant C will be either charging or discharging through R. When the voltage at point 2 in the circuit passes through the transfer voltage level of the first inverter, this inverter switches and causes the second inverter to switch. The voltage at this point

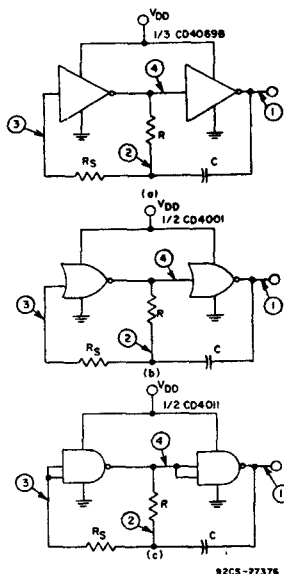

Fig. 1 - Astable multivibrator circuits that employ two COS/MOS inverters.

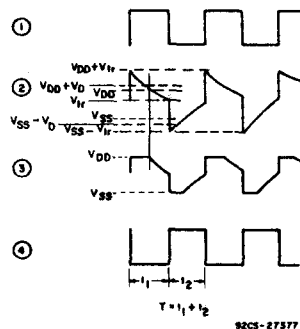

Fig. 2 - RC-oscillator operating waveforms.

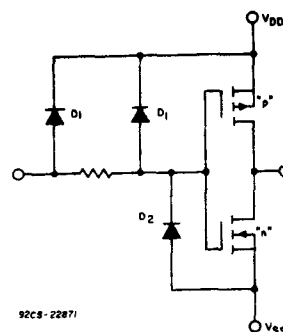

Fig. 3 - Diode protection circuit.

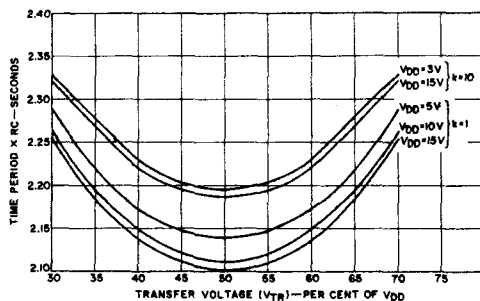

Fig. 4 - Discrete RC-oscillator time period as a function of transfer voltage.

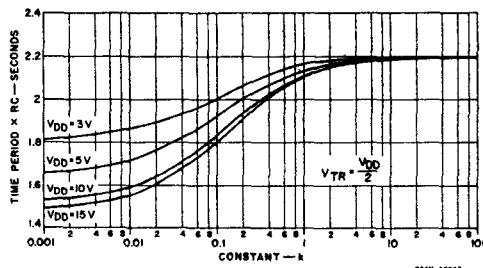

Fig. 5 - Discrete RC-oscillator time period as a function of constant, k.

# ICAN-6466

is allowed to switch well above  $V_{DD}$  and below  $V_{SS}$  because of  $R_S$ . The large swing reduces the effects of variations in transition voltage ( $V_{TR}$ ). The variable characteristics of the input protection circuit and their effect on stability are greatly reduced because of  $R_S$ .

The equation for the period,  $T$ , of the circuits in Fig. 1 is given by Eq. 1:<sup>2</sup>

$$T = -RC \ln \frac{(V_{TR})(V_{DD} - V_{TR})}{(V_{DD} + V_{DD})^2} - \frac{(K)}{(K+1)} RC \ln \frac{K(V_{DD} + V_D)}{K(V_{DD} + V_{TR}) + (V_{TR} - V_D)} - \frac{(K)}{(K+1)} RC \ln \frac{K(V_{DD} + V_D)}{K[2V_{DD} - V_{TR}] + (V_{DD} - V_{TR} - V_D)} \quad (1)$$

where  $K = \frac{R_S}{R}$

With the equation in this form it is easy to see that as  $K$  approaches infinity the variation in period as a function of  $V_{DD}$  is reduced to zero. This result is shown in Fig. 4, where period as a function of transfer voltage is plotted for various values of  $V_{DD}$  and  $K$ , and in Fig. 5, which shows period as a function of  $K$  for various values of  $V_{DD}$ . Variation in period with transfer voltage is also reduced as  $K$  increases. This variation decreases from 10 percent for  $K = 0$  to approximately 5 percent as  $K$  becomes large.

There are some limitations on the value of  $R_S$ . It must not be made too large since a time constant and phase shift is produced by  $R_S$  and stray wiring and breadboard capacitance. This shift creates a switching delay in the circuit that changes the time period and, in addition, may cause spurious oscillations and glitches in the multivibrator circuit. A reasonable value for  $K$  would be anywhere from 2 to 10, with maximum and minimum values for  $R_S$  determined by the above considerations.

Table I shows data measured when typical units were employed in the circuits of

Fig. 1. Fig. 6 shows a typical transfer characteristic as a function of temperature. The curve shows that there is very little change in characteristic from low to high

TABLE I - FREQUENCY VARIATIONS OF ASTABLE MULTI-VIBRATORS UNDER NORMAL CONDITIONS

UNIT NO.	$V_{TR}$ $V_{DD} = 10V$ (V)	PERIOD (ms)		
		CD4009B		
		$V_{DD} = 5V$	$V_{DD} = 10V$	$V_{DD} = 15V$
1	5.27	0.988	1.03	1.07
2	5.19	0.988	1.04	1.06
3	5.58	0.990	1.03	1.07
4	5.26	0.990	1.03	1.07
5	5.25	0.991	1.03	1.07

UNIT NO.	$V_{TR}$ $V_{DD} = 10V$ (V)	CD4001A		
		$V_{DD} = 5V$	$V_{DD} = 10V$	$V_{DD} = 12V$
1	4.08	0.998	1.00	1.00
2	3.92	0.982	0.986	0.990
3	4.76	0.979	1.01	1.01
4	4.07	0.974	0.962	0.962
5	4.42	0.965	0.981	0.991

UNIT NO.	$V_{TR}$ $V_{DD} = 10V$ (V)	CD4011A		
		$V_{DD} = 5V$	$V_{DD} = 10V$	$V_{DD} = 12V$
1	5.41	1.01	1.02	1.03
2	5.08	1.00	1.03	1.04
3	5.76	0.990	1.00	1.01
4	5.98	0.983	0.996	1.01
5	5.24	0.996	1.00	1.00

$R_S = 0.82 M, R = 0.43 M, C = 910 pF, T = 25^\circ C$

temperature. Because the oscillators can also tolerate changes in transfer characteristic without frequency instability, they require no thermal compensation. The frequency at  $-55^\circ C$  is extremely close to that at  $+125^\circ C$ .

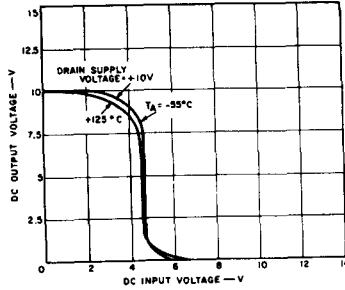

Fig. 6 - Transfer characteristic as a function of temperature.

Table II shows data measured on typical units at temperature extremes. The astable multivibrators shown in Fig. 1 can be gated on and off by use of a NOR or NAND gate as the first inverter, as shown in Fig. 7.

TABLE II - FREQUENCY VARIATIONS OF ASTABLE MULTIVIBRATORS AT TEMPERATURE EXTREMES

UNIT NO.	PERIOD (ms)																	
	CD4009B				CD4001AF				CD4011AF									
	$V_{DD} = 5V$ -55°C	$V_{DD} = 10V$ -55°C	$V_{DD} = 15V$ -55°C	$V_{DD} = 5V$ 125°C	$V_{DD} = 10V$ -55°C	$V_{DD} = 10V$ 125°C	$V_{DD} = 12V$ -55°C	$V_{DD} = 12V$ 125°C	$V_{DD} = 5V$ -55°C	$V_{DD} = 10V$ -55°C	$V_{DD} = 10V$ 125°C	$V_{DD} = 12V$ -55°C	$V_{DD} = 12V$ 125°C					
1	0.960	0.974	0.993	1.011	1.023	1.047	0.930	0.924	0.934	0.931	0.936	0.943	0.937	0.937	0.950	0.955	0.958	0.960
2	0.961	0.974	0.997	1.011	1.033	1.045	0.926	0.929	0.947	0.947	0.953	0.956	0.931	0.934	0.942	0.944	0.951	0.956
3	0.965	0.975	0.992	1.010	1.028	1.044	0.914	0.902	0.926	0.918	0.929	0.920	0.925	0.927	0.946	0.949	0.958	0.960
4	0.961	0.973	1.000	1.011	1.033	1.045	0.914	0.903	0.929	0.923	0.936	0.935	0.933	0.931	0.948	0.943	0.950	0.949
5	0.963	0.975	0.994	1.009	1.029	1.043	0.930	0.923	0.955	0.930	0.966	0.938	0.934	0.933	0.959	0.955	0.962	0.963

$R_S = 0.82 M, R = 0.43 M, C = 910 pF$ .

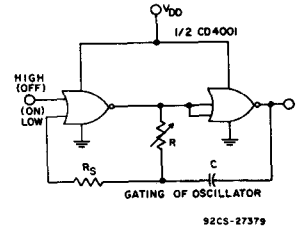

Fig. 7 - Astable multivibrator in which a NOR or NAND gate is used as the first inverter to permit gating of the multivibrator.

### Compensation For 50-Percent Duty Cycles

The variation in transfer voltage described above affects the output-pulse duty cycle, as shown in Fig. 8. A true square-wave pulse is obtained only when the transfer voltage occurs at the 50-percent point. However, the duty cycle can be controlled if part of the resistance in the RC time constant is shunted

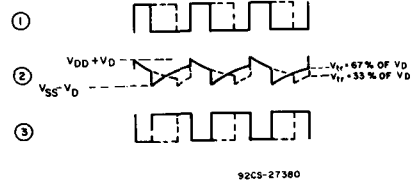

Fig. 8 - Waveforms showing effects of transfer voltage on multivibrator frequency.

out with a diode, as shown in Fig. 9. Because adjustment of this diode shunt to obtain a specific pulse duty factor causes the frequency of the circuit to vary, a frequency control,  $R_3$ , is added to compensate for this variation. It may also be necessary to reverse the diode to obtain the desired duty factor. The frequency of any of the circuits shown can be made variable by replacing the timing resistor with a potentiometer.

### Jitter In Astable Circuits

When using the astable circuits described above with other equipment and/or circuits that require off-the-board connections, some

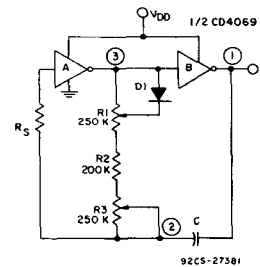

Fig. 9 - Astable multivibrator in which a duty-cycle control is added.

jitter in the output waveform may be encountered. This jitter is introduced into the circuit by noise picked up by the connecting cables and board capacitance and stray wiring. This problem can be corrected with the addition to the circuit of an inverter, as shown in Fig. 10, that isolates the frequency determining circuit nodes from pickup by the output node. The

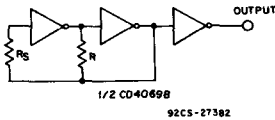

Fig. 10 - Astable multivibrator circuit with buffered output.

output to the astable circuit is then taken from the output of the added inverter.

**Monostable Circuits**

Fig. 11(a) shows a basic one-shot circuit that uses a single RC time constant. This circuit operates well provided it is adjusted to the COS/MOS unit used. If no adjustment is made, the period T can vary from unit to unit by -40 percent to +60 percent if the transfer voltage varies by ±33 percent, as shown by the waveforms in Fig. 11(b).

The use of some resistance r, Fig. 11, is generally advisable to limit the current if V<sub>DD</sub> is greater than 5 volts.

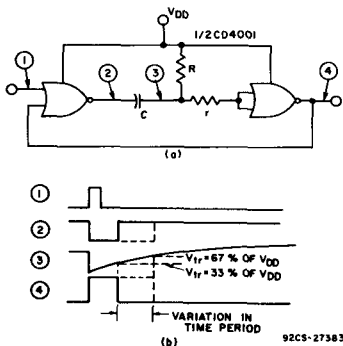

Fig. 11 - Basic one-shot multivibrator circuit: (a) circuit diagram, (b) waveforms.

**Compensated Monostable Circuit**

Fig. 12 shows a compensated monostable multivibrator type of circuit that can be triggered with a negative-going pulse (V<sub>DD</sub> to ground). In the quiescent state, the output of inverter B is high. When a negative-going pulse or spike is introduced into the circuit, as shown in the waveforms of Fig. 13, capacitor C<sub>1</sub> becomes negatively charged to ground and the output of inverter A becomes high. Capacitor C<sub>2</sub> then charges to the value of V<sub>DD</sub> through diode D<sub>1</sub> and

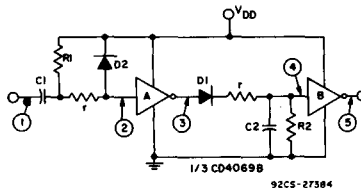

Fig. 12 - Compensated monostable multivibrator circuit.

inverter A, and the output of inverter B becomes low. As capacitor C<sub>1</sub> discharges negatively, it charges through resistor R<sub>1</sub> to the

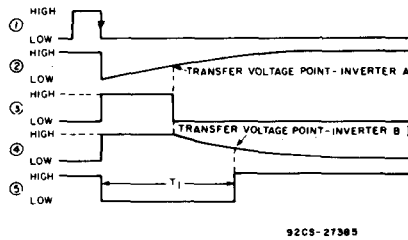

Fig. 13 - Voltage waveforms for monostable multivibrator circuit when a negative-going trigger pulse is applied.

value of V<sub>DD</sub> (waveform 2). The output of inverter A remains high until the voltage generated by the charging of C<sub>1</sub> is equal to the transfer voltage of inverter A (i.e., until the waveform generated by the charging of C<sub>1</sub> passes through the transfer-voltage curve of inverter A); at that instant the output of inverter A becomes low. Diode D<sub>1</sub> temporarily prevents the discharge of capacitor C<sub>2</sub>, which was charged when inverter A was high (waveform 3). Capacitor C<sub>2</sub> then commences to discharge to ground through resistor R<sub>2</sub> (waveform 4). The output of inverter B remains low until the voltage generated by the discharge of C<sub>2</sub> becomes equal to the voltage at the voltage transfer point of inverter B (i.e., until the waveform generated by the discharge of C<sub>2</sub> passes through the transfer-voltage point of inverter B); at that point the output returns to its high state (waveform 5).

The advantage of using two inverters fabricated on the same chip is that they have similar transfer voltages. When two equal RC time constants are used (R<sub>1</sub>C<sub>1</sub> = R<sub>2</sub>C<sub>2</sub>), the effects of variations in transfer voltage from device to device are effectively cancelled out, as shown in Fig. 14. Eq. (1) can be used to show that the maximum variation in the time period T is less than 9 percent. The total time for one period,

T<sub>1</sub>, is approximately 1.4 times R<sub>1</sub>C<sub>1</sub>.

Unlike the astable circuit, which shows little variation in frequency over the temperature range from -55°C to +125°C, the monostable multivibrator shows some change in time period; the variation is less than 10

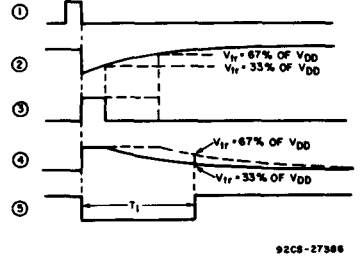

Fig. 14 - Waveforms showing the cancelling effects of transfer-voltage variations of the two COS/MOS inverters when two equal time constants are used.

percent. Table III shows data measured on five units over the temperature range cited above. At 25°C, the variation in the time period T from unit to unit is very small, usually less than 5 percent at a V<sub>DD</sub> of 10 volts.

The output from inverter B can be held in the low or zero state as long as the R<sub>2</sub>C<sub>2</sub> time constant is reinforced by another triggering pulse before the discharge waveform it generates passes through the transfer-voltage point of inverter B.

Diode D<sub>2</sub> in Fig. 12 is internal to the COS/MOS circuit. As discussed for the astable oscillator, it is part of the input protection circuit shown in Fig. 2, and clamps the input at V<sub>DD</sub>.

Figs. 15 and 16 show two variations of the monostable circuit together with their associated waveforms. The circuit of Fig. 15 triggers on the negative-going excursions of the input pulse in the same manner as the circuit of Fig. 12. The output pulse is positive-going and is taken from the first inverter. This circuit does not need an external diode. The circuit of Fig. 16 triggers on the positive-going excursion of the input pulse, and then locks back on itself until the RC time constants complete their discharge. The circuits of Figs. 15 and 16 cannot be retrigged until they return to their quiescent states.

**Low Power Monostable Circuit** - The monostable circuits discussed thus far dissipate some power because one or both of the inverters are on during the charging or discharging of the capacitor. This power dissipation will be extremely low provided the

# ICAN-6466

TABLE III - FREQUENCY VARIATION OF MONOSTABLE MULTIVIBRATORS OPERATING AT THREE TEMPERATURES

UNIT NO.	PERIOD (ms) CD4098BE								
	-55°C			+25°C			+85°C		
	V <sub>DD</sub> = 5V	V <sub>DD</sub> = 10V	V <sub>DD</sub> = 15V	V <sub>DD</sub> = 5V	V <sub>DD</sub> = 10V	V <sub>DD</sub> = 15V	V <sub>DD</sub> = 5V	V <sub>DD</sub> = 10V	V <sub>DD</sub> = 15V
1	0.73	0.40	0.30	0.74	0.41	0.32	0.74	0.41	0.32
2	0.74	0.38	0.34	0.76	0.40	0.36	0.76	0.41	0.36
3	0.76	0.40	0.32	0.75	0.40	0.34	0.75	0.40	0.34
4	0.76	0.36	0.35	0.74	0.42	0.36	0.74	0.42	0.36
5	0.75	0.42	0.34	0.76	0.41	0.35	0.76	1.42	0.36

UNIT NO.	PERIOD (ms) CD4001A								
	-55°C			+25°C			+125°C		
	V <sub>DD</sub> = 5V	V <sub>DD</sub> = 10V	V <sub>DD</sub> = 12V	V <sub>DD</sub> = 5V	V <sub>DD</sub> = 10V	V <sub>DD</sub> = 12V	V <sub>DD</sub> = 5V	V <sub>DD</sub> = 10V	V <sub>DD</sub> = 12V
1	0.39	0.45	0.50	0.41	0.46	0.50	0.41	0.46	0.51
2	0.40	0.46	0.50	0.42	0.46	0.50	0.43	0.47	0.50
3	0.40	0.47	0.52	0.43	0.49	0.54	0.43	0.49	0.55
4	0.42	0.46	0.50	0.44	0.47	0.53	0.43	0.48	0.54
5	0.40	0.44	0.48	0.41	0.46	0.51	0.42	0.46	0.51

UNIT NO.	PERIOD (ms) CD4011A								
	-55°C			+25°C			+125°C		
	V <sub>DD</sub> = 5V	V <sub>DD</sub> = 10V	V <sub>DD</sub> = 12V	V <sub>DD</sub> = 5V	V <sub>DD</sub> = 10V	V <sub>DD</sub> = 12V	V <sub>DD</sub> = 5V	V <sub>DD</sub> = 10V	V <sub>DD</sub> = 12V
1	0.58	0.53	0.49	0.57	0.52	0.48	0.56	0.52	0.48
2	0.55	0.50	0.45	0.54	0.50	0.44	0.55	0.50	0.45
3	0.56	0.52	0.44	0.55	0.51	0.44	0.55	0.50	0.44
4	0.55	0.52	0.46	0.56	0.52	0.46	0.57	0.52	0.46
5	0.56	0.50	0.46	0.57	0.51	0.46	0.58	0.50	0.46

R<sub>1</sub> = R<sub>2</sub> = 43 M, C<sub>1</sub> = C<sub>2</sub> = 910 pF

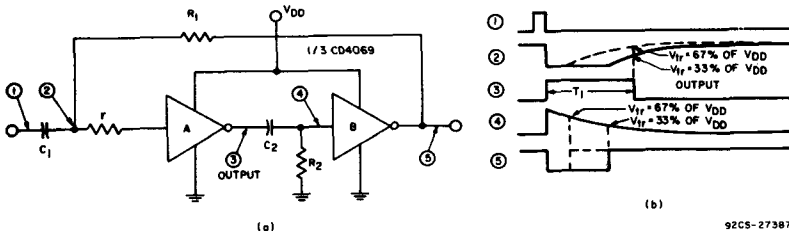

Fig. 15 - Monostable multivibrator that is triggered by a negative-going input pulse: (a) circuit diagram, (b) waveforms.

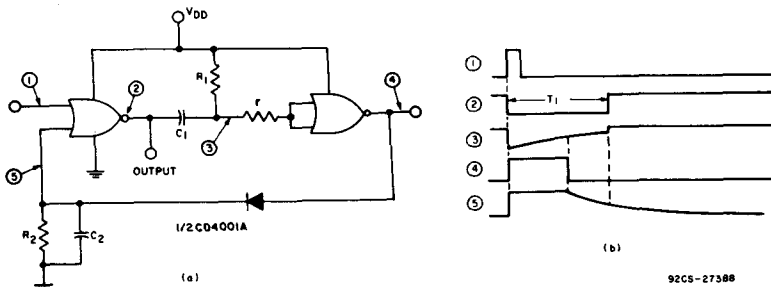

Fig. 16 - Monostable multivibrator that is triggered by a positive-going input pulse: (a) circuit diagram, (b) waveforms.

"one-shot" pulse width is short compared to the overall cycle time. Fig. 17 shows the current waveform associated with the circuit of Fig. 12. This waveform is very wide at the base, and some current flows for approximately twice the time period.

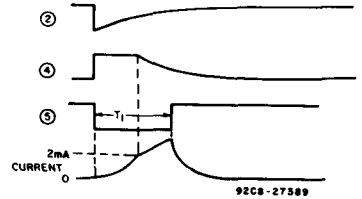

Fig. 17 - Current waveforms for the diode-compensated multivibrator shown in Fig. 12.

Fig. 18(a) shows a circuit using the CD4007A. This device dissipates much less

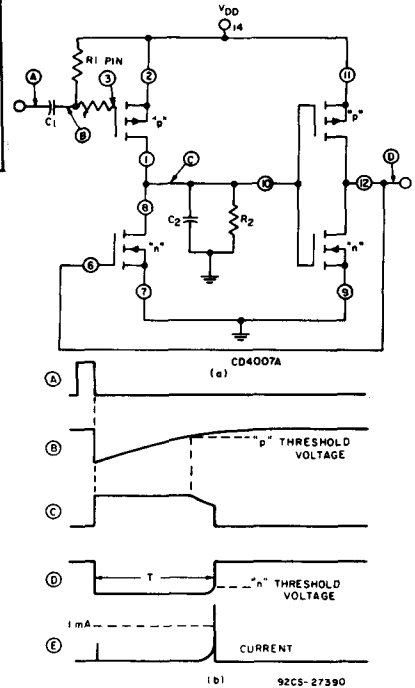

Fig. 18 - Low-power monostable multivibrator: (a) circuit diagram, (b) waveform.

power than the other circuits shown but is not as stable; circuit operation is described by the waveforms in Fig. 18(b). In the quiescent state, the p-channel transistor of the first inverter is biased off while the n-channel transistor (which derives its control from the output of the second inverter) is biased on. Therefore, the output at C is low, and that at D is high. When a negative-going pulse is introduced into the circuit through capacitor C<sub>1</sub>, the p-channel device is turned on.



Capacitor  $C_2$  then charges to  $V_{DD}$ , the output at D becomes low, and the n-channel device of the first inverter is turned off. Capacitor  $C_1$  immediately begins to charge to  $V_{DD}$  through  $R_1$  (waveform B). The p-channel transistor remains on, keeping capacitor  $C_2$  charged to  $V_{DD}$  until the voltage generated reaches the threshold voltage level and turns the transistor off. The n-channel transistor of the first inverter is still off because the output of the second inverter (waveform D) is still low. When the p-channel device of the first inverter turns off, capacitor  $C_2$  begins to discharge through resistor  $R_2$  (waveform C) to ground. As  $C_2$  discharges, the voltage passes through the threshold-voltage point of the second p-channel transistor, and that transistor begins to turn on. The voltage then begins to rise (waveform D), and the n-channel device of the first inverter turns on and provides a second discharge path for capacitor  $C_2$ . As a result, the output waveform changes state from low to high very rapidly to complete the cycle.

The major advantage of the circuit of Fig. 18 is its low power dissipation. Because the circuit depends on the p-channel transistor threshold, the time period T varies from unit to unit and with temperature variations. Some compensation can be provided if the  $R_2C_2$  time constant is made approximately three times larger than the  $R_1C_1$  time constant, as shown in Table IV.

TABLE IV - FREQUENCY VARIATIONS OF MONOSTABLE MULTIVIBRATORS WITH TEMPERATURE WHEN  $R_2C_2$  TIME CONSTANT IS LARGE COMPARED TO  $R_1C_1$

CD4007A UNIT NO.	PERIOD WITH $V_{DD} = 10$ V (ms)		
	-55°C	25°C	125°C
1	0.740	0.759	0.779
2	0.740	0.754	0.760
3	0.730	0.735	0.735
4	0.750	0.750	0.759

$R_1 = 100K, R_2 = 1 M, r = 36K, C_1 = C_2 = 910 pF$

Current in the circuit of Fig. 18 can be minimized by removing capacitor  $C_2$  so that only stray capacitance is present at the input of the second inverter. A comparison of time-period variations under this condition is shown in Table V. Again, the variations from unit to unit are caused by differences in p-channel transistor threshold.

TABLE V - FREQUENCY VARIATIONS OF MONOSTABLE MULTIVIBRATORS WITH TEMPERATURE WHEN  $C_2$  CONSISTS OF STRAY CAPACITANCE ONLY

CD4007A UNIT NO.	PERIOD WITH $V_{DD} = 10$ V (ms)		
	-55°C	+25°C	125°C
1	0.121	0.125	0.129
2	0.110	0.115	0.118
3	0.120	0.124	0.127
4	0.103	0.105	0.108

$R_1 = 100K, R_2 = 1M, r = 36K, C_1 = 910 pF, C_2 = \text{Stray}$

APPLICATIONS

Voltage-Controlled Oscillators

Fig. 19 shows a circuit similar to the circuit in Fig. 1. C is variable (by adjustment of  $C_X$ ) and R is variable (by adjustment of  $V_A$ ). The value of R varies from approximately 1 kilohm to 10 kilohms. These limits are determined by the parallel combi-

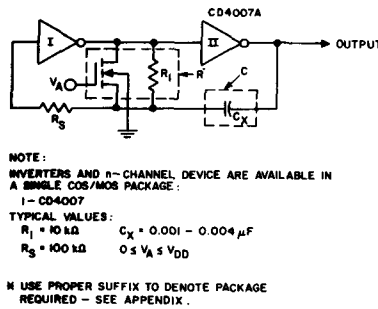

NOTE: INVERTERS AND n-CHANNEL DEVICE ARE AVAILABLE IN A SINGLE COS/MOS PACKAGE:  
 I - CD4007  
 TYPICAL VALUES:  $R_1 = 10 k\Omega, C_X = 0.001 - 0.004 \mu F, R_S = 100 k\Omega, 0 \leq V_A \leq V_{DD}$

USE PROPER SUFFIX TO DENOTE PACKAGE REQUIRED - SEE APPENDIX.

92CS-22878R

Fig. 19 - Voltage controlled oscillator.

nation of  $R_1$  (10 kilohms) and the resistance of the n-channel device, which varies from 1 kilohm ( $R_{ON}$ ) to approximately  $10^9$  ohms ( $R_{OFF}$ ).

When  $V_A = V_{SS}$ , the n-channel device is off and  $R = R_{OFF} \parallel R_1$ , which is approximately equal to  $R_1$  or 10 kilohms because  $R_{OFF}$  is very much greater than  $R_1$ . When  $V_A = V_{DD}$ , the n-channel device is fully on and  $R = R_{ON} \parallel R_1$  or approximately  $R_{ON}$ , which is equal to 1 kilohm because  $R_{ON}$  is very much less than  $R_1$ .

The center frequency of the oscillator is varied by adjustment of  $C_X$ .

Voltage-Controlled Pulse-Width Circuits

Fig. 20(a) shows a further modification of the circuit of Fig. 1(a); in the modified circuit the pulse width may be modulated by varying  $V_A$ , but only if  $R_X$  is sufficiently high. As an example: if  $C = 0.0022$  microfarads,  $R_X$  will be approximately 35 kilohms. Lower values of  $R_X$  have an adverse effect on

frequency. If  $R_X$  is less than 10 kilohms, there is a value of  $V_A$  that will cause the oscillator to cut off. Table VI lists values of

TABLE VI - PULSE WIDTH AS A FUNCTION OF  $V_A$  AND  $V_{DD}$

$V_A$	PULSE WIDTH $\mu s$		
	$V_{DD} = 5$ V	$V_{DD} = 10$ V	$V_{DD} = 12$ V
0	30	28	28
0.5	30	28	28
1.0	30	28	27
1.5	28	26	27
2.0	26	24	22
2.5	26	22	20
3.0	-	21	20
3.5	-	21	20

$C = 0.0015 \mu F, \text{Period} = 55 \mu s$

pulse width (B in Fig. 20(b)) for various values of  $V_A$  and  $V_{DD}$ . Fig. 20(b) shows the waveform for the circuit described.

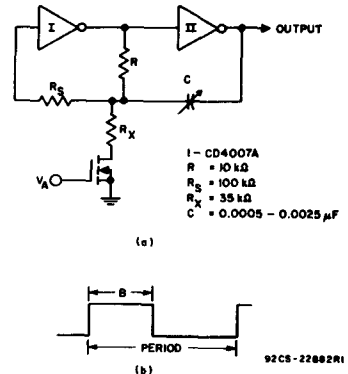
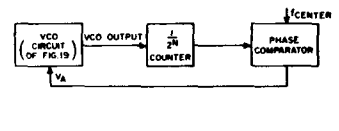

Fig. 20(a) - Voltage controlled pulse-width circuit, (b) output waveform.

Phase-Locked Voltage-Controlled Oscillator

The voltage-controlled oscillator, VCO, can be operated as a phase-locked oscillator by the application of a frequency-controlled voltage to the gate of the n-channel device. Fig. 21 shows the block diagram of an FM discriminator using the phase-locked VCO. Block A is the same circuit of Fig. 19. The output of the phase comparator is fed to the gate of the n-channel device (VA). If the two inputs to the phase comparator are different, the change of VA causes the output frequency of the VCO to change,



92CS-2739I

Fig. 21 - VCO used in phase-locked loop.

# ICAN-6466

Fig. 22. This change is divided by  $2^N$  and fed back to the phase comparator.

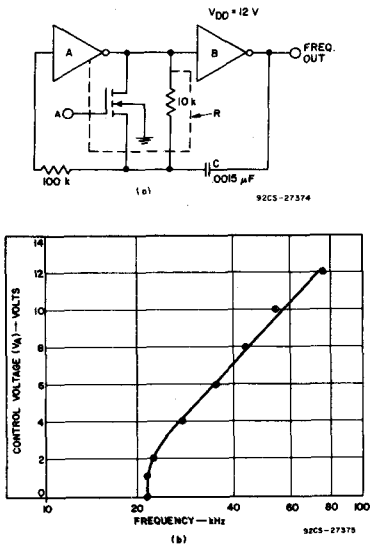

Fig. 22 - (a) VCO, (b) control voltage as a function of output frequency.

## Frequency Multipliers

Fig. 23(a) shows a frequency doubler. A  $2^N$  multiplier can be realized by cascading this circuit with N-1 other identical circuits. The leading edge of the input signal, differentiated by  $R_1$  and  $C_1$  and applied to input

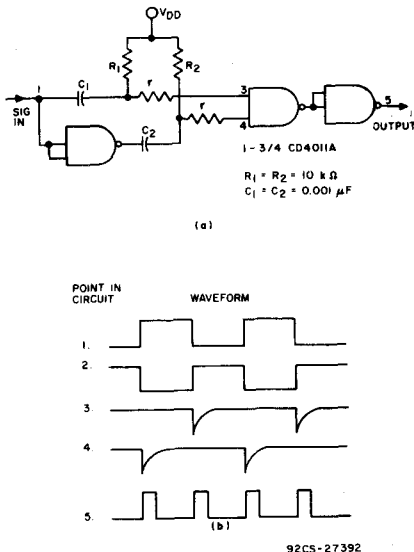

Fig. 23 - (a) Frequency-doubler schematic, (b) waveforms.

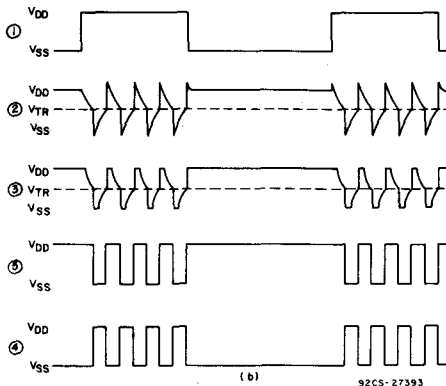
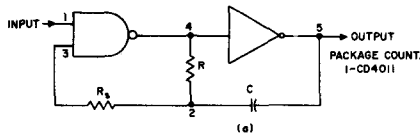

Fig. 24 - (a) Modulator circuit, (b) waveforms.

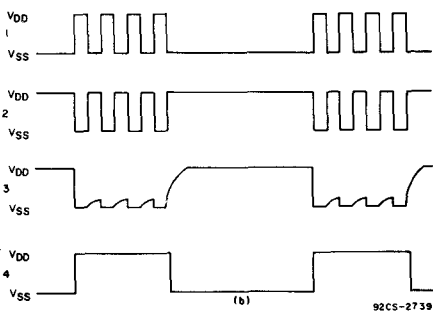
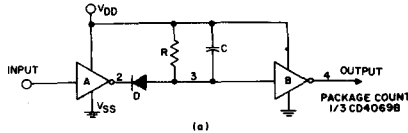

Fig. 25 - (a) Demodulator circuit, (b) waveforms.

No. 1 and the NAND gate, produces a pulse at the output. The trailing edge of the input pulse, after having been inverted, is differentiated and applied to input No. 2 of the NAND gate; it produces the second output pulse from the NAND gate. The waveforms for five points in the circuit are shown in Fig. 23(b).

## Modulation/Demodulation (Envelope Detection)

Pulse modulation may be accomplished by use of the circuit shown in Fig. 24(a). This circuit is another variation of Fig. 1.

Modulation or envelope detection of pulse-modulation waves is performed by the circuit shown in Fig. 25(a). The carrier burst is inverted (by inverter A); its first negative transition at point 2 turns on the diode (D) to provide a charging path for C through the n-channel resistance to ground. On the positive transition of the signal (at point 2), the diode is cut off and C discharges through R. The discharge time constant (RC) is much greater than the time of the burst-signal period. Point 3, therefore, never reaches the switch point of inverter B until the burst has ended. The waveforms for 4 points in the circuit are shown in Fig. 25(b).

## References

1. Further information on astable and monostable circuits using MSI devices may be found in RCA Application Note ICAN-6230, "Using the CD4047 in COS/MOS Timing Applications", and in the RCA Data Sheet for the CD4098 Dual Monostable Multivibrator. (Note: COS/MOS Hex Buffers CD4009A and Quad Buffer CD4041A are not recommended for use as multivibrators because of very high power consumption in the linear mode for long time constants. In addition, the hex buffers have a large imbalance between  $I_{source}$  and  $I_{sink}$  capability, which makes oscillator start-up more unpredictable.)
2. For the derivation of this equation, see RCA Application Note ICAN-6230, "Using the CD4047A in COS/MOS Timing Applications."

# Guide to Better Handling and Operation of CMOS Integrated Circuits

by J. Flood and H. L. Pujol

This Note recommends specific handling and operating practices that minimize the probability of damage to CMOS integrated circuits in the manufacturing operation and the field environment.

A description of various gate-oxide networks that protect against electrostatic discharge in both A-series and B-series RCA COS/MOS product is provided. A practical explanation of the SCR latch-up mechanism and its associated failure mode is given. In addition, operating procedures that help prevent device malfunction are described.

## HANDLING CONSIDERATIONS

All CMOS devices are susceptible to damage by the discharge of electrostatic energy between any two pins. The gate input is equivalent to a small, low-leakage capacitor (5 picofarads typical) in parallel with a very high resistance ( $10^{12}$  ohms typical). This extremely high input impedance lends itself readily to the buildup of electrostatic charges. Therefore, because the gate-oxide breakdown of a CMOS device is typically 80 volts, damage by high levels of electrostatic discharge can occur.

To protect the gate oxide against high levels of electrostatic discharge, protective networks are implemented on all RCA CMOS (COS/MOS) devices, as described below.

### Standard Protection Networks

Fig. 1 shows the standard protection network incorporated on all A-series devices

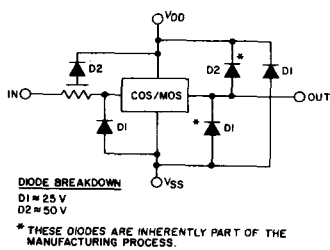

Fig. 1 - Standard protection network.

and some B-series devices. Input-diode D2 is a distributed resistor-diode network that appears as two diodes to VDD.

### Improved Protection Network

Fig. 2 shows the improved protection network incorporated on most new B-series devices as well as on all A-series, B-converted types.

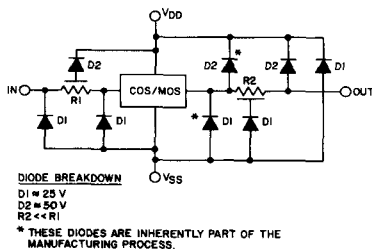

Fig. 2 - Improved protection network.

### Other Protective Networks

Fig. 3 shows the modified protective network for a CD4049/4050 buffer. The input diode to VDD is not incorporated so that the level-shifting function can occur.

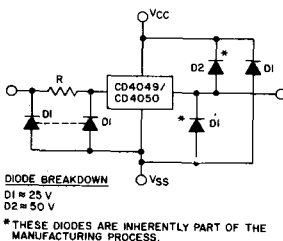

Fig. 3 - Modified protection network.

Fig. 4 shows a transmission gate with the intrinsic diodes that protect against electrostatic discharge.

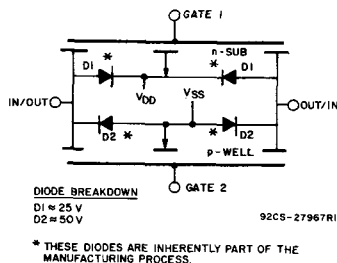

Fig. 4 - Transmission gate with intrinsic diodes that protect against electrostatic discharge.

The protection networks described in this Note were characterized by using the equivalent body discharge network of Fig. 5. There are 12 possible combinations by which a device can be damaged. A discussion of the combinations is beyond the scope of this Note; however, Table I shows worst-case protection levels for the above networks.

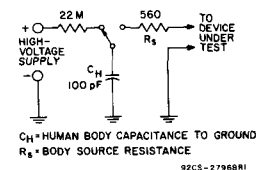

Fig. 5 - Equivalent-body discharge network.

Additional protection can be obtained by adding external series resistors at device inputs. The value of this resistance should be in the range of 10 kilohms for gate inputs and 1 kilohm for transmission gate inputs, where applicable. In addition, zener diodes at the output pins can clamp the voltage at a safe level. The zener value should not exceed the absolute maximum rating of the part.

On-chip protection resistors are not used on transmission gates so as to maintain low on resistance. Some recent designs, however, do have protection diodes to VDD and VSS close to the bond pads. The 800-volts worst case capability is provided by the intrinsic diodes shown in Fig. 4.

TABLE I - Worst-Case Capability of Protective Networks

Protective Network	Worst-Case Capability
Standard (inc. CD4049, CD4050)	1 kV to 2 kV
Improved	4 kV
Transmission Gate	< 800 V

### General Handling Rules

Table I indicates the typical, worst-case voltage discharges from the network of Fig. 5 that the above networks can withstand. Because every manufacturing environment is different, levels above those shown in Table I should be anticipated and protected against by following the handling recommendations of Table II.

Dry weather (relative humidity less than 30 percent) tends to increase greatly the accumulation of static charges on any surface. Conversely, higher humidity levels (40 to 50 percent) tend to reduce the magnitude of the static voltage generated. In a low-humidity environment, the handling precautions listed above take on added importance and should be adhered to without exception.

### HANDLING OF UNMOUNTED CHIPS

In handling unmounted chips, differences in potential should be avoided. A conductive carrier or a carrier having a conductive overlay should be used. Another important consideration is the sequence in which bonds are made; the VDD (device supply) connection should always be made before the VSS (ground) bond.

### HANDLING OF SUBASSEMBLY BOARDS

After COS/MOS units have been mounted on circuit boards, proper handling precau-

**TABLE II — General Handling Recommendations**

	Should be conductive	Should be grounded to common point
Handling equipment	X	
Metal Parts of Fixtures and Tools		X
Handling Trays	X	
Soldering Irons		X
Table Tops	X	X
Transport Carts	X	
Manufacturing Operating Personnel		Utilize grounded, metal or conductive plastic wrist straps with 1-megohm series resistor
General Handling of Devices		Utilize grounded, metal or conductive plastic wrist straps with 1-megohm series resistor

tions should still be observed. Until these subassemblies are inserted into a complete system in which the proper voltages are applied, the board is no more than an extension of the leads of the device mounted on the board.

It is good practice to put conductive clips or conductive tape on the circuit-board terminals. This precaution prevents static charges from being transmitted through the board wiring to the devices mounted on it.

### AUTOMATIC HANDLING EQUIPMENT

When automatic handling equipment is used, it may not always be possible to eliminate static electricity through grounding techniques alone. Automatic feed mechanisms must be insulated from the devices under test at the point where the devices are connected to the test set. The anvil transport portion of the automatic handling mechanism can generate very high levels of static electricity as a result of the continuous flow of devices over and then separating from the anvil. Total control of these static voltages is critical because of the high throughputs associated with automatic handling.

Fortunately, the resolution of this problem is simple, practical, and inexpensive. Ionized-air blowers, which supply large volumes of ionized air to objects that are to be charge neutralized, are commercially available from many supply sources. Field experience with ionized-air techniques reveals this method to be extremely effective in eliminating static electricity when grounding techniques cannot be used.

### Failure Mechanisms

Electrical damage resulting from handling is usually caused by either of the two following failure mechanisms:

1. Low-level static electricity (voltage of 1 kV to 4 kV). Input diode protection may be overstressed and input leakage currents as high as 1 milliampere across diodes may cause a malfunction.
2. High-level static electricity (voltages greater than 4 kV). Gate oxides may become short-circuited. Inputs to VDD or VSS terminals will be low-impedance inputs.

The presence of these types of device malfunction can be detected by curve-tracer checks of the input protection diodes described above. Diode degradation resulting from static electricity is observable in the low-reverse-breakdown characteristics shown on the curve tracer. On the other hand, damage resulting from high levels of static electricity are observed as a resistive short to VDD or VSS.

### Typical Manufacturing Area Procedure

The example below illustrates all of the above recommendations for handling CMOS devices in a typical manufacturing environment. Although existing protective networks offer a high level of protection against electrostatic discharge, this example emphasizes specific precautions that can help eliminate damage.

#### Receiving Area

Devices should not be removed from their conductive or antistatic carriers. If devices are not received in conductive or antistatic packing material, they should be returned to the supplier.

#### Incoming Inspection

**Physical** — Parts should be counted without removing them from their containers.

**Storage** — Devices should remain in carriers. Even a partial removal of IC's from a carrier should only be done by a grounded operator. Devices removed should be placed in a conductive tray.

**Electrical** — All testing should be performed by a grounded operator. Devices should be reinserted in conductive carriers after completion of a test.

#### PC Board Assembly

It is desirable that PC boards have shorting bars installed prior to assembly (soldering). Where possible, CMOS IC's should be the last component installed on the PC board.

Boards should be transported to the wave-solder area in conductive carriers. Flux removal should be done with an acceptable solvent. Examples of specific, acceptable alcohols are isopropanol, methanol and special denatured alcohols such as SDA1, SDA30, SDA34 and SDA44. The removal of flux

from non-hermetic and molded-plastic devices by means of soap and water in a dishwasher is NOT recommended as this procedure will adversely affect the long-term life of the device.

### OPERATING CONSIDERATIONS

Proper operating procedures are as important as proper handling techniques. A review of RCA COS/MOS A-series and B-series operating characteristics and ratings is given in Table III.

#### Operating Voltage

When devices are operated near the maximum supply-voltage range, power-supply turn-on or turn-off transients, power-supply ripple or regulation, and ground noise should be suppressed; any of the above conditions must not cause (VDD - VSS) to exceed the absolute maximum rating. A good practice is to use a zener protection diode in parallel with the power bus. The zener value should be above the expected maximum regulation

excursion, but should not exceed the maximum supply voltage. Fig. 6 illustrates a practical zener shunt circuit. A current-limiting resistor is included if the supply-current compliance is higher than the zener power-dissipation rating for a given zener voltage. The shunt capacitor value is chosen to supply required peak-current switching transients.

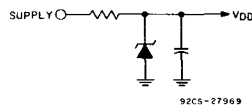

Fig. 6 — Zener-diode shunt circuit.

#### Unused Inputs

All unused input leads must be connected to either VSS or VDD, whichever is appropriate for the logic circuit involved. A floating input on a high-current type (such as the CD4009A, CD4010A, CD4041A, CD4049A, CD4050A) can result not only in faulty logic operation, but can cause the maximum power dissipation of 500 milliwatts to be exceeded; the result may be damage to the device. Another consideration with high-current devices is the need for a pull-up resistor between the inputs and VSS or VDD should there be any possibility that the device terminals may become temporarily open or unconnected (e.g., if the printed circuit board driving the high-current types is removed from the chassis). A useful range of values for such resistors is from 0.2 to 1 megohm.

#### Input Signals

Signals should not be applied to the inputs while the device power supply is off unless the input current is limited to a steady-state value of typically less than 10 milliamperes. Input-signal interfaces that are the allowable 0.5 volt above VDD or below VSS should be current-limited to typically 10 milliamperes or less.

Whenever the possibility of exceeding 10 milliamperes of input current exists,

**TABLE III — Maximum Ratings of RCA COS/MOS Devices**  
(Voltages referenced to  $V_{SS}$ )

DC Supply Voltage Range	3 to 15 V (A Series); 3 to 20 V (B Series)
Recommended Operating Voltage	3 to 12 V (A Series); 3 to 18 V (B Series)
DC Input Voltage Range	-0.5 to $V_{DD} + 0.5$ V
Dissipation per Package	500 mW
Device Dissipation per Output Transistor	100 mW
Storage Temperature Range	-65 to +150°C
Operating Temperature Range	
Ceramic Package Types	-55 to +125°C
Plastic Package Types	-40 to +85°C
Lead Temperature (during soldering) at a distance 1/16 ± 1/32 inch (1.59 ± 0.79 mm) from case for 10 seconds max.	+ 265°C

a resistor in series with the input is recommended. The value of this resistor can be as high as 10 kilohms without affecting static electrical characteristics. However, speed will be reduced because of the added RC delay. Particular attention should be given to long input-signal lines where high inductance can increase the likelihood of large-signal pickup in noisy environments. In these cases, series resistance with shunt capacitance at the IC input terminals is recommended. The shunt capacitance should be made as large as possible consistent with the system speed requirements.

**Fan-Out — COS/MOS to COS/MOS**

All RCA COS/MOS devices have a dc fan-out capability of greater than 50. The reduction in COS/MOS switching speed caused by added capacitive loading should, however, be consistent with high-speed system design. The input capacitance is typically 5 picofarads for most types; the CD4009 and CD4049 buffers have a typical input capacitance of 15 picofarads.

**Maximum Clock Rise and Fall Time**

All COS/MOS clocked devices show maximum clock rise- and fall-time ratings (normally 5 to 15 microseconds). With longer rise or fall times, a device may not function properly.

**Parallel Clocking**

When two or more different CMOS devices use a common clock, the clock rise time must be kept at a value less than the sum of the propagation delay time, the output transition time, and the setup time. Most flip-flop and shift-register types are included in this rule and are so noted in the individual data sheets.

**Output Short Circuits**

Shorting of outputs to  $V_{SS}$  or  $V_{DD}$  can cause the device power dissipation to exceed the safe value of 500 milliwatts. In general,

outputs of these types can all be safely shorted when the device is operated with  $(V_{DD} - V_{SS}) \leq 5$  volts, but the 500 milliwatt dissipation ratings may be exceeded at higher power-supply voltages. For cases in which a short-circuited load, such as the base of a p-n-p or n-p-n bipolar transistor, is directly driven, the device output characteristics given in the published data should be consulted to determine the requirements for safe operation below 500 milliwatts. Note that a single output transistor short must be limited to 100 milliwatts.

**SCR Latch-Up**

Operation above maximum ratings can force CMOS devices into a p-n-p-n SCR "latch-up" mechanism, which can be destructive. Any transients should be avoided and any large loads occurring during operation near the maximum rating should be avoided.

"Latch-up" is considered to be the creation of a low-resistance path between the power supply and ground on a circuit during an electrical pulse; the path remains a low-resistance path after the pulse. In CMOS circuits, several parasitic bipolar transistors exist, as shown in Fig. 7. The p-n-p transistor is a wide-base lateral structure whose  $\beta$ , normally less than 0.2, is a function of device geometry. The conditions for SCR turn-on are as follows:

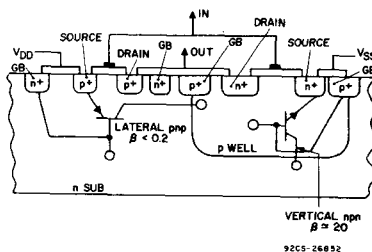

Fig. 7 — Parasitic bipolar transistors in CMOS circuits.

1.  $\beta$  n-p-n x  $\beta$  p-n-p  $\geq 1$   
(vert.) (lat.)
2. The lateral p-n-p and vertical n-p-n base emitter junctions are forward biased.
3. The bias circuit that applies power to  $V_{DD}$  and to the input must be capable of supplying current equal to the holding current of potential SCR's.

Fig. 8 shows the equivalent circuit for the SCR structure present in CMOS circuits.

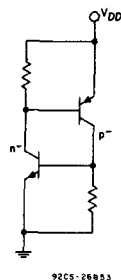

Fig. 8 — Equivalent circuit for the SCR structure present in CMOS circuits.

Fig. 9 shows a curve of  $I_{DD}$  as a function of  $V_{DD}$ , which illustrates the effect of secondary breakdown and SCR latch-up.

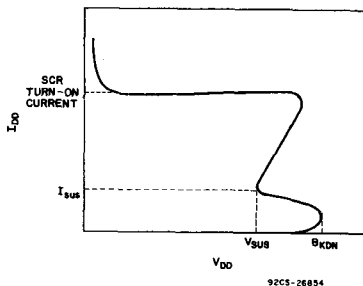

Fig. 9 — Curve illustrating effect of secondary breakdown and SCR latch-up.

Table IV shows typical values of breakdown voltage and sustaining voltage and current for RCA COS/MOS A-series and B-series devices. The table shows that B-series devices are much harder to latch than A-series types because of the higher breakdown voltage.

**TABLE IV — Breakdown Voltage and Sustaining Voltage and Current Values**

Characteristic	A-Series	B-Series
$V_{BKDN_{min}}$	17 V	25 V
$V_{SUS}$	15 V	22 V
$I_{SUS}$	Type-Dependent 50–100 mA 2–40 mA	

# Fundamentals of Testing COS/MOS Integrated Circuits

by J. Flood

This Note describes the techniques employed in testing RCA COS/MOS devices to assure their adherence to data-sheet specifications, and provides information useful in data-sheet interpretation and in the inspection of incoming devices. RCA COS/MOS devices are available in two basic families: A-series (3- to 15-volt product) and B-series (3- to 20-volt product).

RCA COS/MOS circuits are 100-percent tested by circuit probe in the wafer stage and are 100-percent tested again after they have been packaged. DC tests of RCA devices are performed at 5, 10, 15, and 20 volts; functionality is checked at 3, 17, and 22 volts depending on family (i.e., A or B series). Sample testing is used to assure adherence to quality requirements and ac specifications.

Static tests, high-speed functional and dc parametric tests, are performed at wafer and package stages by means of a Teradyne J283 test set. A Teradyne S157CM test set and a Macrodatta MD154 test set are used in dynamic testing. Dynamic tests are performed with 15 and 50 picofarad loads. Testing at 15 picofarads is accomplished primarily by laboratory "bench-test" techniques; automatic testing at 15 picofarads is difficult because of the high input capacitance (approximately 20 to 35 picofarads) of most automatic ac test sets.

Users should follow the sequence below when testing COS/MOS devices:

1. Insert the device into the test socket.
2. Apply VDD.
3. Apply the input signal.
4. Perform the test.
5. On completion of test, remove the input signal.
6. Turn off the power supply (VDD).
7. Remove the device from the test socket and insert it into a conductive carrier. COS/MOS devices under test must not be exposed to electrostatic discharge or forward biasing of the intrinsic protective diodes shown in Fig. 1.

For detailed COS/MOS IC handling and operating considerations, refer to RCA Application Note, Guide to Better Handling and Operating of CMOS Integrated Circuits.<sup>1</sup>

## STATIC TESTING

### DC-Parameter Testing

DC parameters are those specified for steady-state conditions; dc testing of RCA devices is done at 5, 10, 15, and 20 volts depending on the family under test. Non-varying forcing conditions are applied to the inputs and/or outputs of a package while the device terminals are monitored for expected voltage or current levels.

DC-parameter tests include:

- Functional tests
- Contact tests (diode measurement)
- Leakage tests: quiescent and input
- Breakdown voltage tests
- Output voltage levels

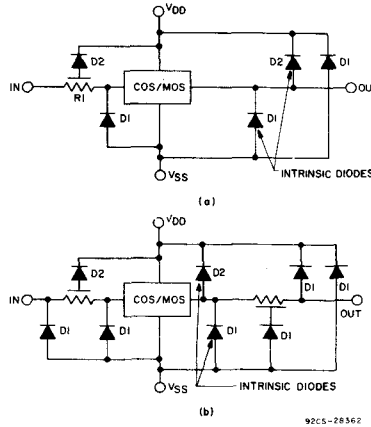

Fig. 1 - (a) Standard protection network used on all CD4000A- and some CD4000B-series devices; (b) improved protection network used on all new RCA COS/MOS devices. Diode breakdown: D1 = 25 V, D2 = 50 V, R2 <<< R1.

- Input voltage test (includes noise-immunity and noise-margin tests)
- Output drive-current measurements
- Diode tests
- Input-capacitance measurements
- Additional tests as required

A typical CMOS IC test sequence is shown in Fig. 2.

### Functional Tests

Functional tests assure that the device under test will perform its logical operations in accordance with its truth table. The operating voltages for functional tests are shown in Table I. Operation is checked

Table I - Operating Voltage Limits For Functional Tests

	Recommended	Min.	Max.
4000A Series	3 - 12	3	15
4000B Series	3 - 18	3	20

against truth table values by monitoring output-voltage levels for valid logic-high and logic-low levels. Output logic levels for functional tests are:

Logic 0:  $\leq V_{SS} + 0.5 V$

Logic 1:  $\geq V_{DD} - 0.5 V$ ,  $V_{DD}$  is referenced to  $V_{SS}$ .

Fig. 3 shows an example of a CD4001 NOR gate functional test.  $V_{DD}$  is selected to cover the desired range of operation. This test is performed at a relatively low frequency ( $\ll f_{CL \max}$ ) and with no load other than stray and probe capacitances.

When complex circuits such as the CD-4094B, Fig. 4, are tested, input signals must

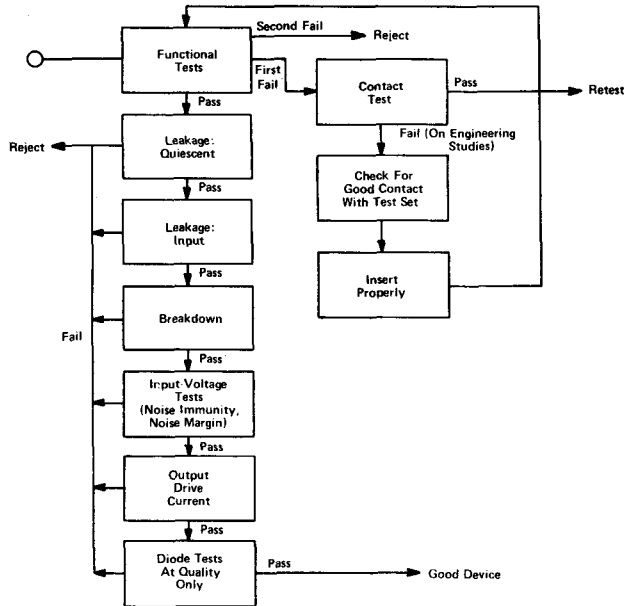

Fig. 2 - A typical COS/MOS IC test sequence.

92CS-28363

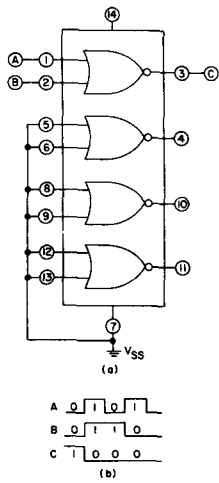

Fig. 3 - Example of CD4001 NOR-gate functional test.

be applied to control the functions being examined. The CD4094B is an 8-stage shift and store register whose eight stages are composed of D-type flip-flops connected in sequential logic form with a common clock.

In addition to the flip-flop chain, the device has a latch option at each parallel output stage; the latch is controlled by the strobe input level. The parallel outputs are three-state and are controlled by the output enable level. Data stored in the register is available at the serial outputs on both the positive and negative clock transitions.

Prior to performance of the static or dc parameter tests, which reflect the data-sheet specifications, all register functions must perform 100 percent. Compliance of a device with functional test requirements is determined by monitoring all outputs for proper operation. Functional testing is performed by applying the waveforms shown in the timing diagram of Fig. 5 to the device under test, in this case the CD4094B of Fig. 4. The tests are performed at a frequency well below the maximum operating frequency of the device. Input logic 1 levels are equal to  $V_{DD}$ ; input logic 0 levels are equal to  $V_{SS}$ . Again, output logic 1 and 0 levels are equal to  $V_{DD} - 0.5$  V min. and  $V_{SS} + 0.5$  V max., respectively. Functional tests for B-series devices are performed at a  $V_{DD} - V_{SS}$  of 22 volts, 2.8 volts, and at intermediate levels depending on the device type.

The timing diagram, Fig. 5, shows 0-level data being clocked into the internal Q output of the shift register while the strobe input is maintained low. After eight positive clock transitions, all the internal Q outputs are at logic 0. Prior to the next positive clock transition, the strobe goes to a 1 state; this condition shifts the zeroes from the internal Q outputs to the external Q outputs and the serial outputs. At this time all outputs are at logic 0. The following clock pulses, those

starting at time slot 1, begin shifting 1's and 0's to the parallel outputs. The alternate 1's and 0's are fed into the register up to the negative transition at time-slot 8. At this time the strobe input is sent low to check functionality of the latch. Note that a 0 data bit was transmitted to the Q1 output on the positive clock transition at time-slot 8; however, a positive transition at time-slot 9 does

not shift the positive data input to the Q1 output. The Q1 output remains latched low because of the low level at the strobe input. When the strobe goes high, the 1 data bit is transmitted to the Q1 output. At this point the latch functionality plus the functions of the strobe, clock, data inputs,  $Q_S$  outputs, and Q outputs, Fig. 4, are fully tested, as shown by the timing diagram.

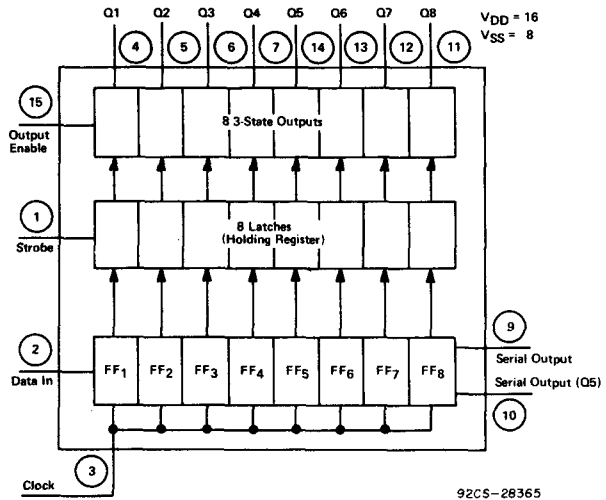

Fig. 4 - Functional diagram of the CD4094B.

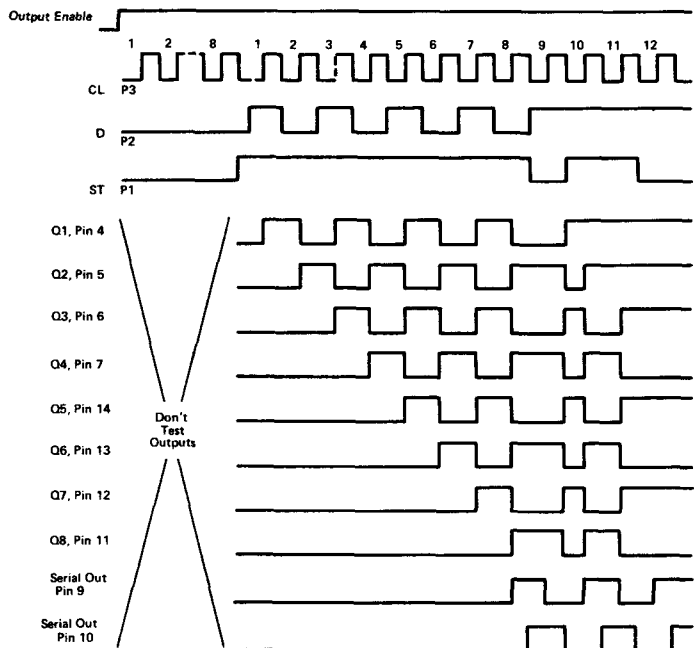

Fig. 5 - Waveforms used in functional testing.

**Leakage Current Tests**

Two types of static leakage currents are of concern in COS/MOS devices: Quiescent-leakage and input-leakage current.

**Quiescent Leakage Current**—In bipolar logic devices, such as TTL devices, the current paths that exist from the power source to ground in the quiescent state cause milliamperes of current to flow even when the device is not functioning. Quiescent leakage may be defined for a COS/MOS device as that current that flows from  $V_{DD}$  to  $V_{SS}$  when, theoretically, all paths for current flow have been opened because the MOS device is off, Fig. 6.

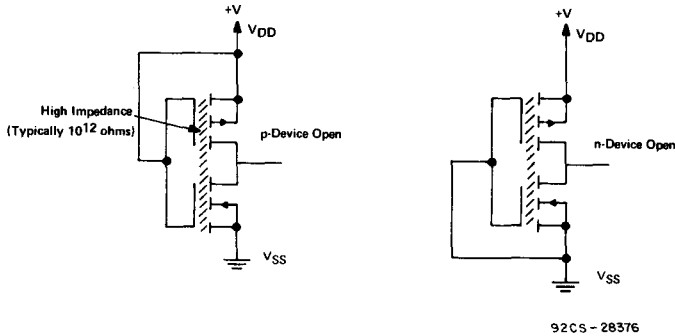

Fig. 6 — Schematic representations of p and n devices when turned off.

There is no perfect switch. However, the COS/MOS technology offers quiescent device currents that are orders of magnitude lower than in other forms of digital logic.

Quiescent-leakage tests are performed for all device states according to their respective truth tables. Voltages for quiescent leakage tests are 5, 10, and 15 volts for the CD4000A series and 5, 10, 15, and 20 volts for the CD4000B series. Power dissipation for COS/MOS devices is in the microwatt range regardless of complexity level, and is relatively stable with variations in temperature.

**Input-Leakage Current**—Input-leakage current is current that flows through reverse-biased diodes, whether intrinsic or diffused, and through the input-protection network connected to the gate. The diodes present in standard and improved protection networks are shown in Fig. 7.

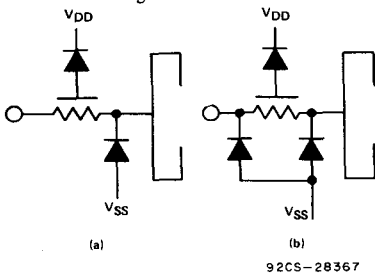

Fig. 7 — (a) Standard and (b) improved protection networks.

Typical input-leakage-current values for COS/MOS devices are in the picoampere range, hence the high input impedance. Automatic test sets cannot measure picoampere values because of test-set resolution. Input currents are measured using 100 nanoamperes as the maximum allowable leakage for a single input.

Examples of quiescent and input leakage test methods are shown in Figs. 8 and 9. In Fig. 8, the quiescent leakage current  $I_L$  ( $I_{DD}$ ) may be substituted for  $I_L$  is measured by eliminating all current paths from  $V_{DD}$  to  $V_{SS}$ . This is done by turning off either the

or the p devices. The current may be measured in the  $V_{DD}$  or the  $V_{SS}$  line, whichever is more convenient. Unused inputs must be connected either high or low, depending on the channel leakage to be measured.

Input leakage current in Fig. 9 is measured by means of the gate input. Typical input impedance is  $10^{12}$  ohms; therefore, typical input leakage currents are in the picoampere range. Figs. 8 through 14 show various test circuits for the CD4001A.

The testing of MSI and LSI parts for quiescent leakage current is more complex than that for SSI devices. However, the test is performed in a manner similar to that of the functional test described previously. The CD4090, for example, is connected as shown in Fig. 15. The device is then clocked into its various states, and the current monitored at applicable time slots.

Fig. 16 shows the intrinsic protection circuitry at each external-gate input. With S1 connected to either current source, the voltage drop from the gate input to ground will be one diode drop. A limit of 1.5 volts maximum is usually used to indicate a good diode. With S1 connected to the +100 microampere supply, the presence of the protective diode to the n substrate is tested. With S1 connected to the -100 microampere supply, the presence of the protective diode to the p well is tested. In the event of functional test failures, the above test can be used as a "contact test" to check for proper insertion of the device under test.

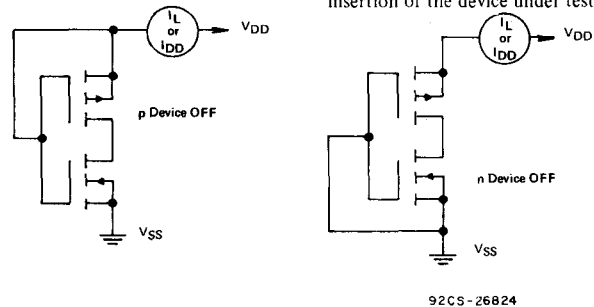

Fig. 8 — Measurement of quiescent leakage current.

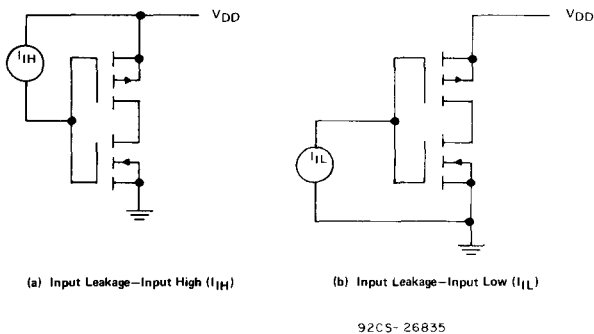

Fig. 9 — Measurement of input leakage.



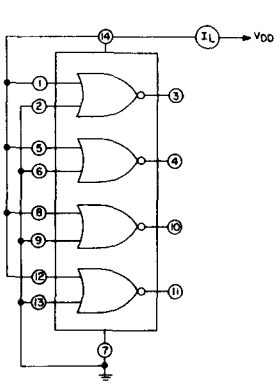

Fig. 10 - Quiescent-device-current test circuit for the CD4001A, leakage-inputs 1 ( $I_L$ ).

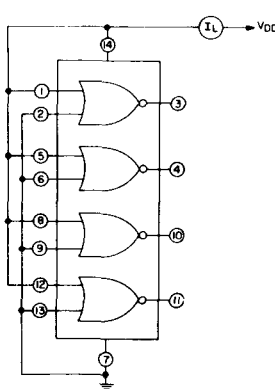

Fig. 11 - Quiescent-device-current test circuit for the CD4001A, leakage-inputs 2 ( $I_L$ ).

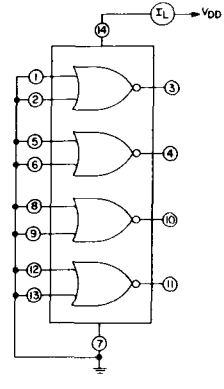

Fig. 12 - Quiescent-device-current test circuit for the CD4001A, leakage - n-devices off ( $I_L$ ).

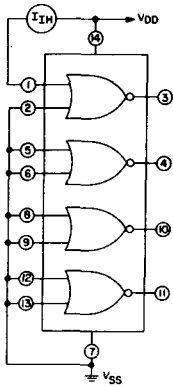

Fig. 13 - Input-current test circuit for the CD4001A, input high ( $I_{IH}$ ).

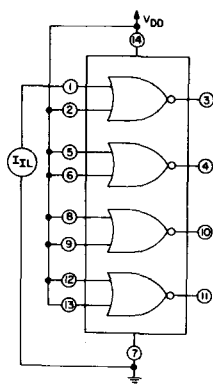

Fig. 14 - Input-current test circuit for the CD4001A, input low ( $I_{IL}$ ).

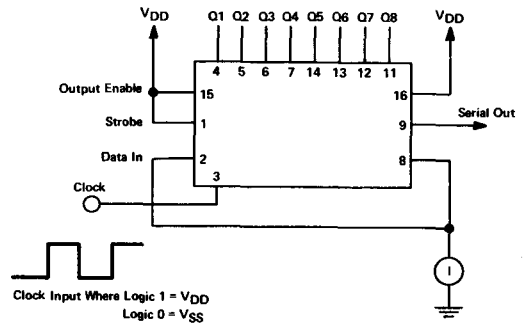

Fig. 15 - Functional-test arrangement for the CD4090.

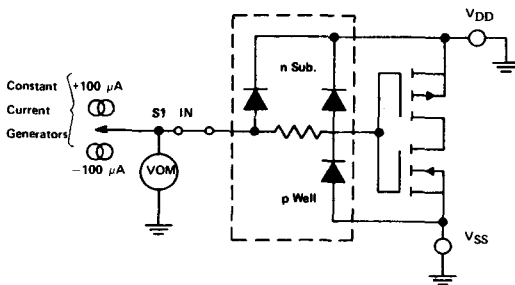

Fig. 16 - Intrinsic protection circuitry at each external input of a COS/MOS device.

**Voltage Breakdown Tests**

Breakdown tests are performed on the n and p channels of COS/MOS devices in a manner similar to that of quiescent-leakage-current tests. The purpose of the breakdown test is to assure that channel breakdowns can only occur at voltages above the maximum guaranteed supply voltage; Table II gives limits by series. Voltage breakdown test circuits are shown in Fig. 17. With switch S1 in position 1, the n devices are on and the p<sup>+</sup>-to-n-substrate diodes are stressed. With switch S1 in position 2, the p devices are on and the n<sup>+</sup>-to-p-well diodes are stressed.

Table II - Channel-Breakdown Limits

	Test Voltage	Max. Current Limit
CD4000A Series	15 V	100 $\mu A$
CD4000B Series	20 V	100 $\mu A$

# ICAN-6532

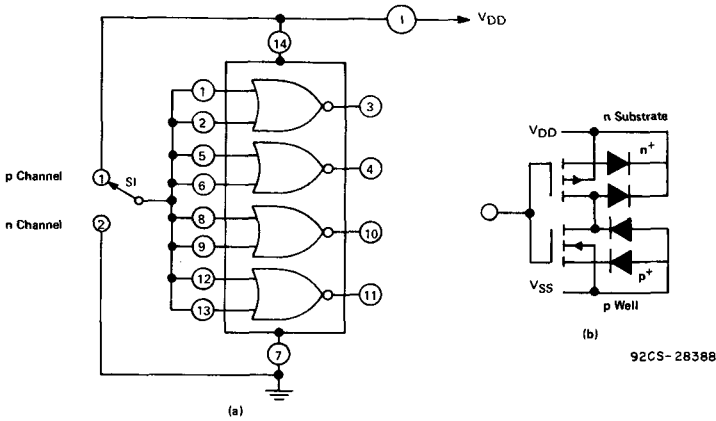

Fig. 17 - Voltage-breakdown test circuit.

### Output-Voltage Levels

The output-voltage low ( $V_{OL}$ ) and the output-voltage high levels ( $V_{OH}$ ) of a COS/MOS device approach  $V_{DD}$  and  $V_{SS}$  within a few millivolts. Tests for  $V_{OL}$  and  $V_{OH}$  are primarily bench-type static tests performed as shown in Fig. 18. With switch  $S_1$  in position 1, one n device is turned on and the p devices are turned off. The voltage

output will be at  $V_{SS} + 0.05$  volt or  $V_{SS} - 0$  volt. With switch  $S_1$  in position 2, all p devices will be turned on and the n devices will be turned off. The voltage output will be at  $V_{DD} + 0$  volt or  $V_{DD} - 0.05$  volt.

Few automatic test sets have the resolution to measure an offset of 50 millivolts from the  $V_{DD}$  and  $V_{SS}$  supply with satisfactory accuracy at reasonable test speeds.

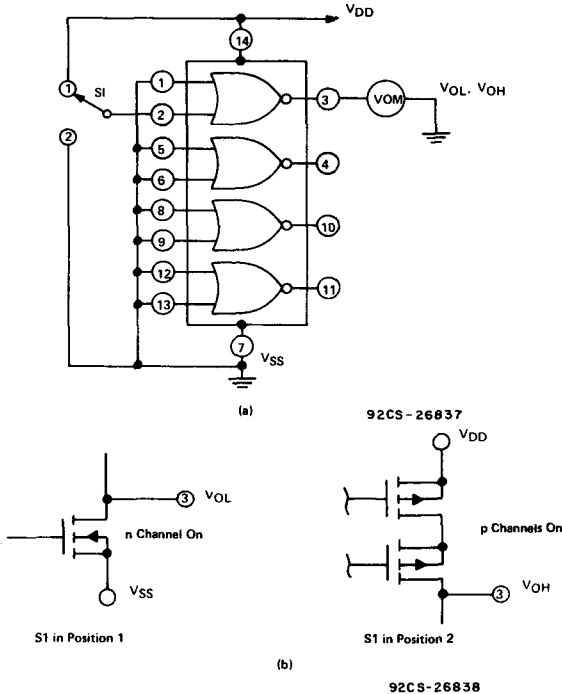

Fig. 18 - Test of output voltage levels ( $V_{OH}$  and  $V_{OL}$ ) of a CD4001A.

Note that in functional testing, the pass/fail criteria for high and low output states of the device is a maximum of 500 millivolts deviation from  $V_{DD}$  and  $V_{SS}$ .

### Noise Immunity

Noise immunity,  $V_{NL}$ ,  $V_{NH}$ , is defined as the maximum low-level input ( $V_{IL}$ ) for which an output logic level does not change state, and the minimum high-level input ( $V_{IH}$ ) for which the output does not change state.

The typical noise immunity of a COS/MOS device is 45-percent of  $V_{DD}$ ; i.e., the input voltage low and high levels will typically change 45-percent of their values before the output logic level changes.  $V_{IL}$  is guaranteed to be a maximum of 30 percent of  $V_{DD}$ ;  $V_{IH}$  is guaranteed to be a minimum of 70 percent of  $V_{DD}$ .

### Noise Margin

Noise margin is the difference between a device output voltage and  $V_{IL}$ ; i.e., the magnitude of noise-margin voltage is that noise voltage that may be added to any COS/MOS input/output mode.

Noise margin and noise immunity are guaranteed to meet data-sheet specifications by the performance of input voltage tests, as shown in Fig. 19. The input voltage test is performed for each device as in functional testing.  $V_{IL}$  and  $V_{IH}$  are applied according to the device's truth table. The outputs are monitored for an expected  $V_{NMH}$  and  $V_{NML}$  state (voltage noise margin, voltage noise margin low).

$$V_{NML} = V_{OL} - V_{IL}$$

$$V_{NMH} = V_{OH} - V_{IH}$$

$$V_{IL} = V_{NL}$$

$$V_{IH} = V_{DD} - V_{NH}$$

### Output Drive Current

Tests for output drive currents— $I_{DN}$  (or  $I_{OL}$ ), sink current, and  $I_{DP}$  (or  $I_{OH}$ ), source current—are conducted by means of the circuits shown in Figs. 20 and 21.

The purpose of the sink-current test, Fig. 20, is to determine the amount of current that the output n device is capable of sinking (with the n channel on) at a given output-voltage level. Fig. 20(a) shows a CD4001AD device whose  $V_{DD}$  is equal to 10 volts and whose voltage output is specified at 0.5 volt. The amount of current that the output device can sink varies depending upon the voltage drop across the device ( $V_{DS}$ ) for a fixed  $V_{GS}$ ; n-channel drain characteristics are shown in Fig. 20(c).

The purpose of the source-current test, Fig. 21, is to determine the amount of current that the p device is capable of sourcing (with the p channel on) at a given output-voltage level. Fig. 21(a) shows a CD4001AD device whose  $V_{DD}$  is equal to 10 volts and whose voltage output is specified at 9.5 volts. Under these conditions, the

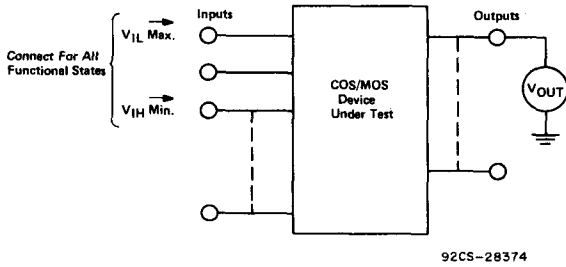
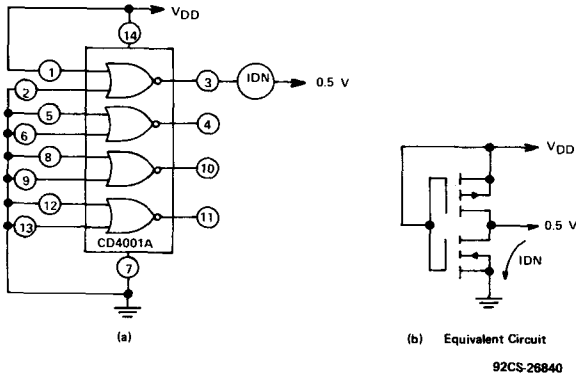
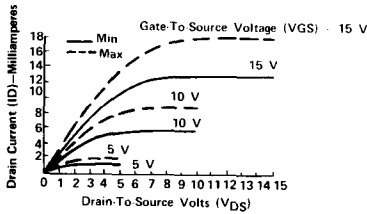

Fig. 19 - Input-voltage-level test arrangement.



92CS-26840



92CS-26841

(c)

Fig. 20 - Output drive current ( $I_{DN}$ ), sink-current, test arrangement.

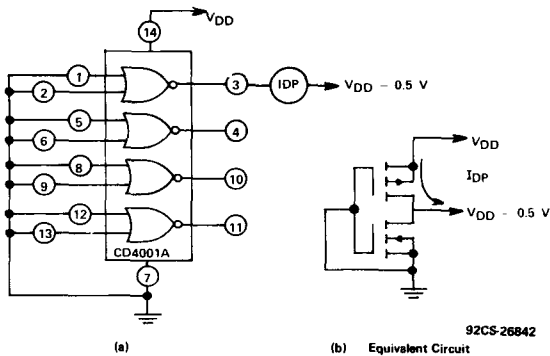

92CS-26842

(b) Equivalent Circuit

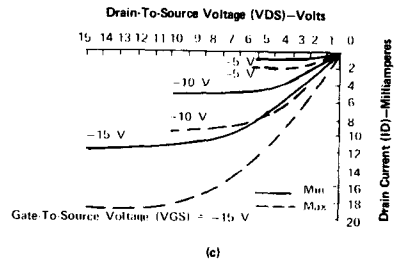

92CS-26843

(c)

Fig. 21 - Output drive current ( $I_{DP}$ ), source current, test arrangement.

output drive current will be a minimum of 0.25 milliampere. The amount of current that the device can source varies depending upon the voltage drop across the device ( $V_{DS}$ ) for a fixed  $V_{GS}$ . p-channel drain characteristics are shown in Fig. 21 (c).

These current-voltage relationships can be verified, theoretically, by the use of the following equations.

In the triode region:

$$I_D = \frac{2K'W}{\ell} \left[ V_{DS} (V_{GS} - V_{TH}) - \frac{V_{DS}^2}{2} \right] \quad 0 \leq V_{DS} \leq (V_{GS} - V_{TH})$$

In the saturated region:

$$I_D = \frac{K'W}{\ell} \left[ V_{GS} - V_{TH} \right]^2 \quad 0 \leq (V_{GS} - V_{TH}) \leq V_{DS}$$

where  $V_{DS}$  = drain-to-source voltage  
 $V_{GS}$  = gate-to-source voltage  
 $V_{TH}$  = device threshold voltage

$$K' = \frac{\mu \epsilon_0}{2t_{ox}} \quad \mu = \text{effective surface mobility of the carrier in the channel}$$

$$\epsilon_0 = \text{permittivity of the oxide}$$

$$t_{ox} = \text{oxide thickness}$$

$W$  = channel width  
 $\ell$  = channel length

Input Capacitance

The input capacitance of a device is measured as shown in Fig. 22. A capacitance bridge is connected between each input and  $V_{SS}$ . The capacitance is then measured after all stray capacitance has been nulled. The test is performed at a 1-MHz bridge setting. Device input capacitance is considered acceptable if the bridge reading is less than the maximum input capacitance specified on the data sheet.

# ICAN-6532

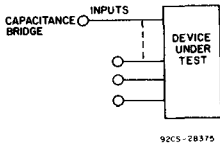

Fig. 22 - Input capacitance measurement.

## DYNAMIC TESTING

### Propagation Delay and Transition Times

**Propagation Delay ( $t_{PLH}$ )** is measured from the 50-percent point of the input pulse to the 50-percent point of the output pulse as the output goes from a low level to a high level.

**Propagation Delay ( $t_{PHL}$ )** is measured from the 50-percent point of the input pulse to the 50-percent point of the output pulse as the output goes from a high level to a low level.

**Transition Time ( $t_{TLH}$ )** is the time required for the output to make the transition from the low state to the high state (n device turns off, p device turns on). This time is measured from the 10-percent point of the output pulse to the 90-percent point of the output pulse.

**Transition Time ( $t_{THL}$ )** is the time required for the output to make the transition from the high state to the low state (p device turns off, n device turns on). This time is measured from the 10-percent point of the output pulse to the 90-percent point of the output pulse.

Dynamic parameters are measured at a specified load of 15 and/or 50 picofarads. The load specified is for total capacitance including stray and probe capacitance. Frequency is not a critical factor in determining switching speeds of COS/MOS devices. Testing should be done at a frequency compatible with the test set or laboratory equipment involved and must be less than the maximum operating frequency. Fig. 23 shows waveforms used in the measurement of propagation delay and transition times.

Note that certain dynamic tests, when performed on a go-no-go basis, are conducted with specified limits as test conditions and with the device outputs monitored. Parameters tested in this way include set-up times, minimum clock, reset and preset pulse widths, clock rise and fall times, maximum clock frequency, and preset and reset removal times. Parameters such as propagation delay and transition times are tested under a set of prescribed conditions so that the test yields actual characteristic data.

### Maximum Operating Frequency

The maximum operating frequency,  $f_{CL}$ , is that clock input frequency above which the device will no longer perform its logical function. This frequency is determined by gradually increasing the input frequency while monitoring the output until the device no longer functions properly. The input frequency is then lowered until the device resumes correct operation. The frequency thus

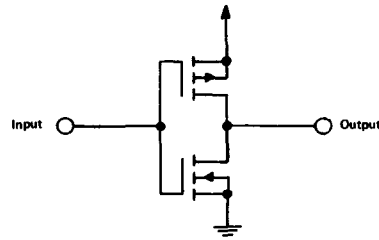

Fig. 23 - Waveforms used in the measurement of propagation delay and transition times.

determined is the maximum operating frequency of the individual device.

When testing for compliance a device for which a maximum operating frequency has been specified, the maximum specified opera-

ting frequency is applied to the device while the outputs are monitored. This is a go-no-go test as opposed to a characterization test.

Fig. 24 shows a CD4013, dual D-type flip-flop, under test for maximum operating

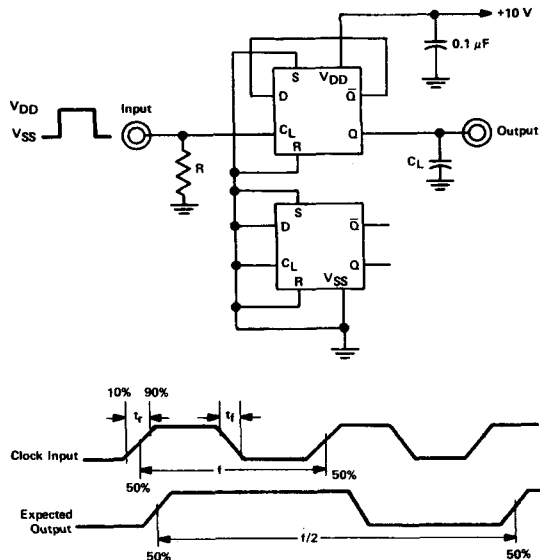

#### Test Conditions (Per Data-Sheet Specifications\*)

- \* Pulse-Generator Amplitude: 10 V
- \* Pulse-Generator Impedance-Matching Resistor (R): 50 ohms
- \* Pulse-Generator Rise and Fall Times ( $t_r = t_f$ ): 20 ns
- \* Pulse-Generator Input Frequency ( $f_{CL}$ ): 7 MHz
- \* Load Capacity -  $C_L$  (including Stray and Probe): 15 pF, 50 pF

92CS-28379

Fig. 24 - Test circuit for measuring the maximum operating frequency of a CD4013A/B.

frequency at an operating voltage of  $V_{DD} - V_{SS}$  of 10 volts.

**Set-Up Time**

Set-up time ( $t_s$ ) is the time interval during which a signal is applied and maintained at a specified input terminal before the device recognizes the presence of the specified input pulse. An example of set-up time measurement for a CD4013, Fig. 25, shows a data input which must be present for time  $t_s$  (value specified in data sheet) in order for the positive transition of the clock pulse to transmit the level at the data input to the Q output. If the data input is not present for a sufficient period of time prior to the positive transition of the clock, the previous state of the data input will be recognized and transmitted to the Q output.

When testing a device for compliance with a specified set-up time, a go-no-go test, the set-up time specified in the data sheet is used as a test condition and the output is monitored for expected operation. When characteristic data is required, the set-up time is varied until the expected output occurs.

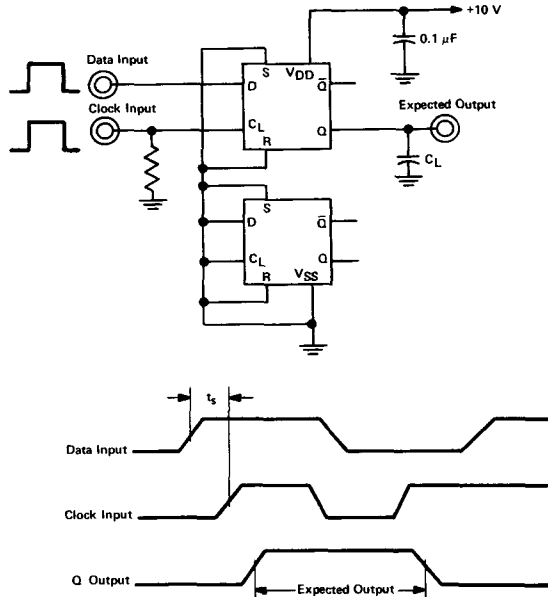

Test Conditions (Per Data-Sheet Specifications\*)

*Pulse-Generator Amplitudes	10 V
*Pulse-Generator Impedance—Matching Resistor (R)	50 ohms
*Pulse-Generator Rise and Fall Times ( $t_r = t_f$ )	20 ns
*Load Capacitance— $C_L$ (Including Stray and Probe)	15 pF, 50 pF
*Setup Time ( $t_s$ )	20 ns

92CS-28380

Fig. 25 — Set-up-time test circuit for a CD4013A.

**Minimum Clock, Set, Reset, and Preset Pulse Widths**

Pulse widths,  $t_W$ , are defined as the time from the point on the leading edge of the clock-pulse curve which is 50-percent of the maximum amplitude to a point on the trailing edge which is 50-percent of the maximum amplitude, Fig. 26. The minimum pulse width for the clock, set, reset, and preset inputs is that time that the pulse must be present in order for the device to recognize the presence of the pulse.

When testing a device for compliance with minimum pulse widths, a go-no-go test, the pulse width specified in the data sheet is used as a test condition and the output is monitored for expected operation. When characteristic data is required, the pulse width is varied until the expected output occurs.

An example of minimum clock-pulse width measurement ( $t_{WH}$ ) for a CD4013 at a  $V_{DD} - V_{SS}$  of 10 volts, Fig. 27, shows the minimum clock-pulse width specified in the data sheet being applied to the clock input of the device under test at a frequency (f) that is less than the maximum operating frequency specified. The clock pulse is applied in one case when the data input is low and is then applied again when the data input is high. (The high and low states of the data input must be present for a time exceeding the specified set-up time.) A device that complies with the minimum clock-pulse width parameter specification will transmit the data input level to the Q output on the positive transition of the clock. Proper operation of the CD4013 can be checked by monitoring for an expected output at Q of f/2.

**Maximum Clock Rise and Fall Times**

The maximum clock rise and fall times ( $t_{rCL}$ ,  $t_{fCL}$ ) are the rise and fall times of

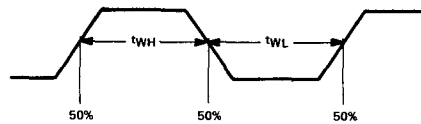

92CS-28377

Fig. 26 — Waveform used to define pulse widths.

the clock input signal (measured from 10 percent to 90 percent), above which the device is guaranteed to perform its logical function. This rise and fall time is determined by gradually increasing the clock rise/fall time while monitoring the output until the device no longer functions properly. The clock input rise and fall times are then lowered until the device resumes correct operation. The rise and fall times thus determined are the maximum clock rise and fall time of the individual device.

In testing a device for maximum clock rise and fall times to a specified limit, the maximum specified clock rise and fall times are applied to the clock input while the output is monitored. The input frequency used to perform this test must be less than the reciprocal of  $2t_r$ , for example, when applying the specified clock rise and fall times for a CD4013 at a  $V_{DD} - V_{SS}$  of 10 volts, the

maximum clock input frequency that may be used is 100 kHz.

Fig. 28 is an example of a test of maximum clock rise and fall times of a CD4013, dual flip-flop, at an operating voltage,  $V_{DD} - V_{SS}$  of 10 volts.

**Reset, Set and Preset Removal Time**

The reset, set, and preset removal time,  $t_{REM}$ , when used in reference to flip-flops, counters, and shift registers, is that time for which the reset, set, or preset pulse must be in its clock enabling state before the device can resume synchronous operation.

When a device is in the preset mode, the JAM input levels are transmitted to the Q output asynchronously. The reset state causes the Q outputs to go to a low level; the set state causes the Q outputs to go to a high level. It is generally an invalid condition to

# ICAN-6532

have a device in more than one asynchronous state at the same time.

In testing a device for compliance with data-sheet specifications, the removal time specified is applied at the appropriate input terminal of the device under test. When characterizing a device, the removal time is adjusted relative to the clock input such that expected operation occurs, decreased to the point where expected operation no longer occurs, and then increased until expected operation reoccurs. The time recorded at the reoccurrence of expected operations is the correct removal time ( $t_{REM}$ ).

An example of a test for minimum preset-able removal time as specified in the data sheet of a CD4029A, presettable up/down counter, is shown in Fig. 29. The JAM inputs J1, J2, J3, and J4 are hard-wired to ground (low). With the preset enable input high, the information on the JAM inputs is transmitted to the Q outputs (regardless of the state of the clock). The preset input is then set low. After a time equal to  $t_{REM}$ , the clock-pulse positive transition advances the counter and causes the Q1 output to go high. The transition of the Q1 output from the low to the high state confirms that the preset enable pulse has been removed for a sufficient time to allow the device under test to resume synchronous clocked operation.

## Reference

1. Guide to Better Handling and Operation of CMOS Devices, ICAN-6525, J. Flood and H. Pujol, RCA Solid State, 1976.

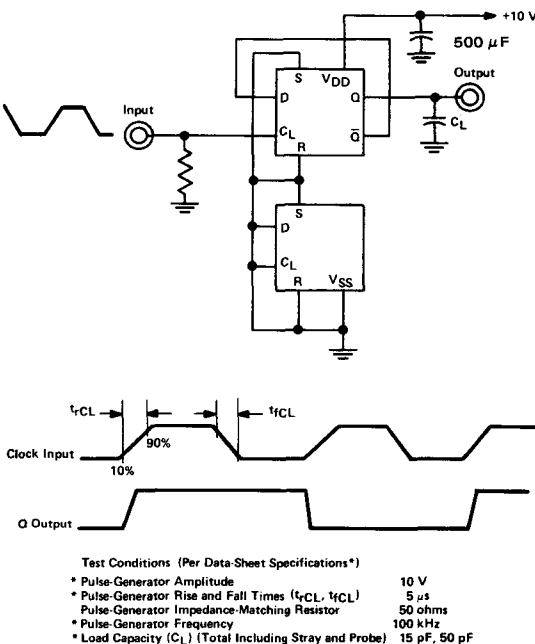

92CS-28381R  
Fig. 28 - Test circuit for measuring maximum clock-rise and fall time in a CD4013A/B.

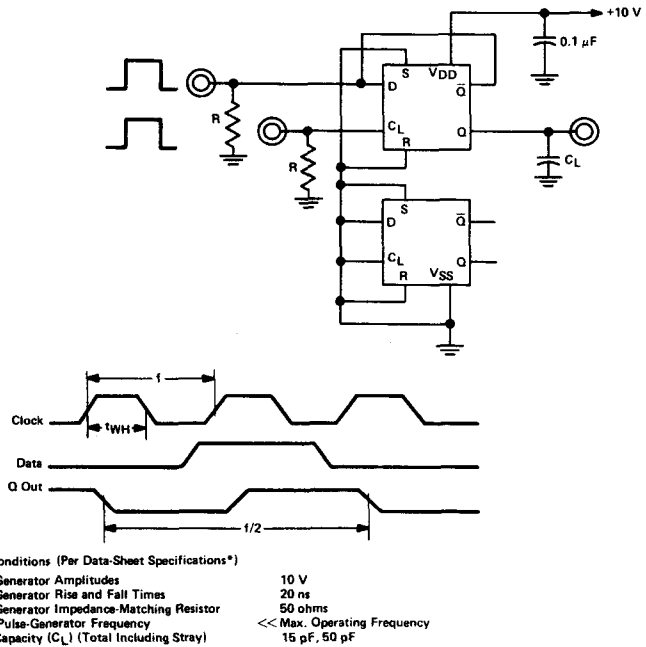

92CS-28383  
Fig. 27 - Test circuit for measuring minimum clock-pulse width in a CD4013A/B.

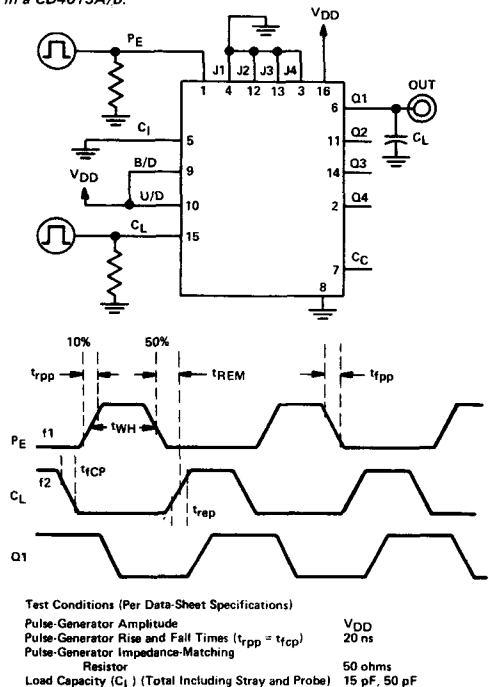

92CS-28382  
Fig. 29 - Test circuit for measuring preset-enable removal time in a CD4029A/B.

# A Basic Selection Guide to Digital Counters

by J. E. Gillberg

The binary ripple counter has emerged as a major building block for today's digital circuit designs primarily because it offers a large amount of information for a set number of bits. In addition, it is simple, requiring no decoding from the counting stages, and its dynamic power consumption is small. This Note discusses these advantages, compares the binary ripple counter with the Johnson decade counter and the BCD counter, and discusses the selection of the most suitable counter for specific applications.

## Design Features

The functional diagram for a COS/MOS 7-stage binary counter type CD4024 is given in Fig. 1. The CD4024

counter. These devices provide alternatives to the digital system designer and have advantages and disadvantages, as does the binary ripple counter.

The CD4017 consists of a 5-stage Johnson decade counter and an output decoder which converts the Johnson binary code to a decimal number. Functional and logic diagrams are given in Fig. 3 for this device. The decade counter includes "anti-lock" gating to assure proper counting sequence. Because the Johnson counter does not use every available combination of outputs, it is possible for the counter to enter an "illegal" mode of operation at power turn-on or as the result of incoming noise. The anti-lock gating forces the counter back into "legal"

operation. For many applications, the disadvantage of the unused logic states, necessitating the use of additional counter stages, is compensated for by its high-speed operation, 2-input decimal decode gating, and spike-free decoded outputs.

The CD4518 BCD synchronous counter requires extra gating to determine what state the counter should be clocked into at the next incoming pulse. Its functional and logic diagrams are given in Fig. 4. Its binary coded decimal output makes it a good choice for many applications where there is machine-to-person interface.

The absence of extra gating in the binary ripple counter, however, allows maximum information density and, therefore, provides a significant advantage over the other two types.

## Power Consumption

The power consumption of any counter depends on the input and output capacitance of the counter, its operating voltage, and the operating frequency. This relationship is expressed by

$$P = CV^2f$$

where P is the power consumption in watts, C the load capacitance in farads, V the operating voltage in volts, and f the frequency of operation in hertz. This expression can be used as a design guide to the power consumption of a circuit when more specific data is not available. The actual power consumption of an IC, however, may vary  $\pm 25$  percent from the value calculated.

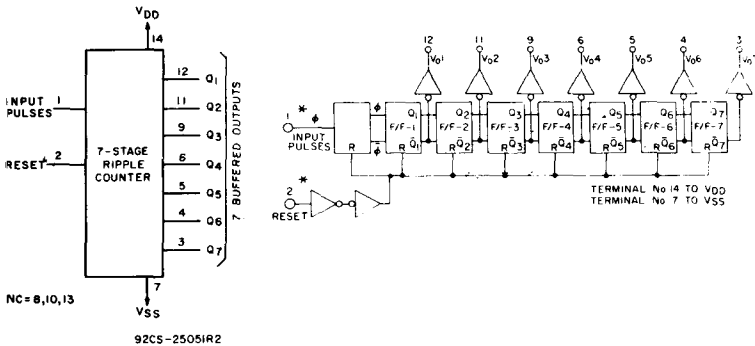

Fig. 1 - Functional and logic diagrams for a COS/MOS 7-stage binary counter type CD4024.

superseded the CD4004 which was the first counter available in the CMOS family of digital devices. This counter is a simple basic design, comprising a series of toggle flip-flops in which the clock input of one flip-flop is connected to the Q output of the previous flip-flop. No additional gating is necessary to perform the binary count. The buffer converter connected to the Q output of each flip-flop stage enhances the current drive without adversely affecting counter speed. Fig. 2 is a detailed diagram of a single master-slave flip-flop used as the sequential memory element in the CD4024, as well as in most static counters.

Two other counters that have found acceptance as digital building blocks are the CD4017, a decade counter/divider using the Johnson decade counter configuration, and the CD4518, a BCD up-

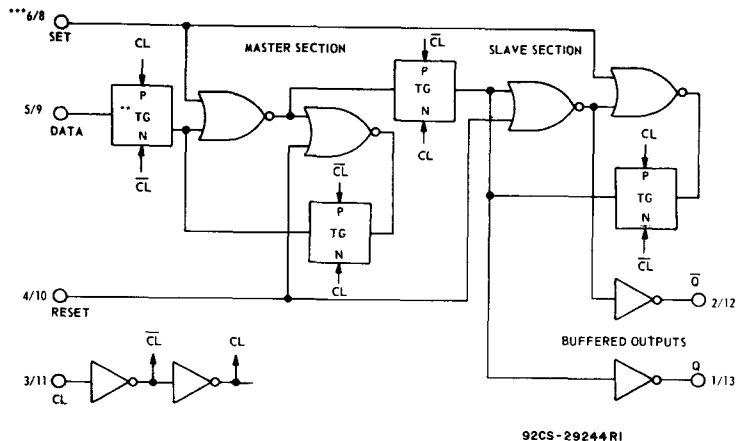

Fig. 2 - Detailed diagram of master-slave flip-flop, the sequential memory element of most static counters including the CD4024.

# ICAN-6552

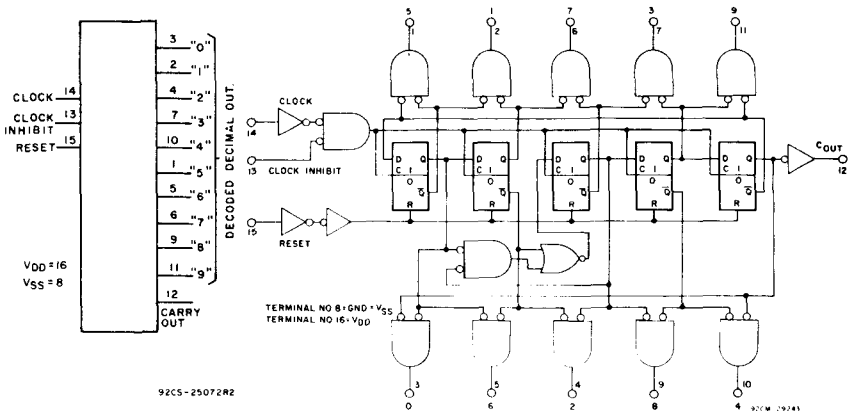

Fig. 3 - Functional and logic diagrams for 5-stage Johnson decade counter type CD4017.

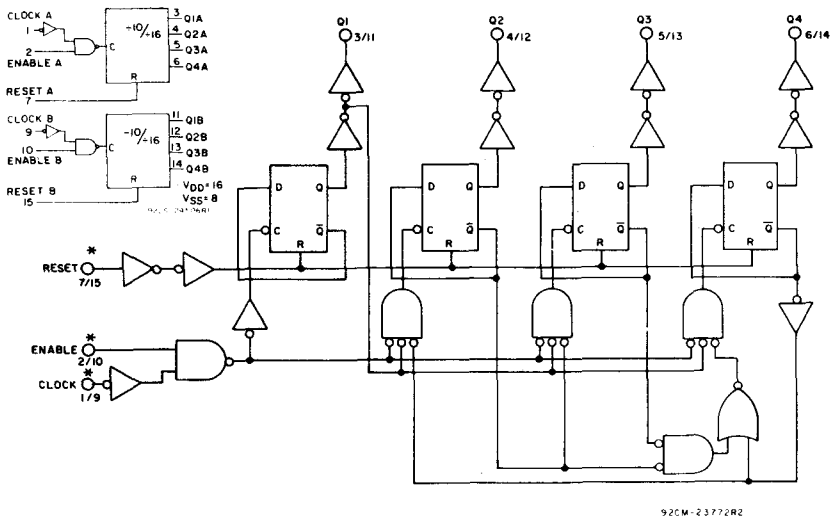

Fig. 4 - Functional and logic diagrams for BCD counter type CD4518.

If it is assumed that the input capacitance of the COS/MOS gate is small compared to the output load capacitance, it can be shown that the power consumption of the binary ripple counter is not too different from that of the other counters. With the CD4013 Quad D Flip-Flop, shown functionally in Fig. 5, used as the example and the dissipation characteristics curves for this device in Fig. 6, one can calculate the power dissipation of a divide-by-sixteen binary ripple counter and compare it to that of a Johnson counter.

The timing diagram given in Fig. 7 shows that each toggle flip-flop in a binary

system is actually a divide-by-two system. The divide-by-sixteen counter would require  $(16 = 2^4)$  four flip-flops. At a clock frequency of 4 MHz, a  $V_{DD}$  of 10 volts, and an output capacitance of 15 pF, this 4-stage network would operate at the following frequencies and, from Fig. 6, dissipate the indicated power:

Stage 1	$2 \times 10^6$ Hz	$2.3 \times 10^3$ $\mu$ W
Stage 2	$1 \times 10^6$ Hz	$1.7 \times 10^3$ $\mu$ W
Stage 3	$0.5 \times 10^6$ Hz	$1.0 \times 10^3$ $\mu$ W
Stage 4	$0.25 \times 10^6$ Hz	$0.5 \times 10^3$ $\mu$ W

Total Power  $5.5 \times 10^3$   $\mu$ W = 5.5 mW

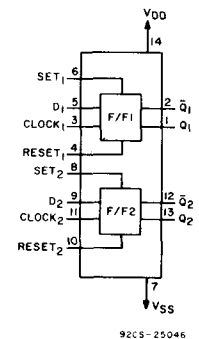

Fig. 5 - Functional diagram of dual D flip-flop type CD4013.



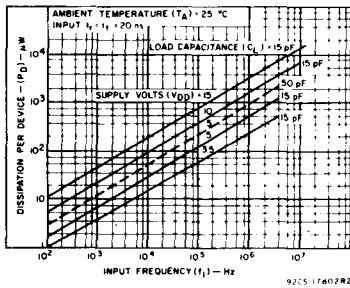

Fig. 6 - Dissipation characteristics curves for type CD4013.

For a Johnson counter, which operates by feeding back the inverted output of the final stage, the number of stages utilizing the CD4013 flip-flop needed for a divide-by-sixteen counter is eight. The outputs are changing at a rate of

$$4 \times 10^6 \text{ Hz} \div 8 = 0.5 \times 10^6 \text{ Hz}$$

Each flip-flop at this frequency and at an operating voltage of 10 volts and an output load of 15 pF would, from Fig. 6, dissipate approximately  $1.0 \times 10^3 \mu\text{W}$ . The total dissipation for the eight flip-flops, therefore, would be  $8 \times 1.0 \times 10^3 \mu\text{W} = 8.0 \text{ mW}$ .

This comparison shows that the power dissipation of these two systems is fairly close in value and should not be the major deciding factor as to which system to use in a specific application.

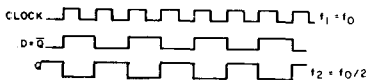

Fig. 7 - Timing diagram for divide-by-two flip-flop.

Information Density

The most significant advantage of binary counters is the amount of information which can be realized from a given number of bits. A comparison of a binary 12-bit system with BCD and Johnson counter 12-bit systems shows that the binary system has 4096 separate states, the BCD system has 1000 separate stages, and the Johnson system has 24 separate states.

In a 12-bit system the binary counter is by far the most compact. In systems using a larger number of bits this advantage is even greater and is becoming increasingly important as manufacturers develop MSI and LSI devices. No longer is the constraint on a design the pellet size, but rather the number of output pins the design uses.

In a system where the goal is a specific output frequency and where the input frequency is variable, the binary ripple counter is and has been the choice of many designers. An excellent example is the design technique usually used in digital clocks and watches. An output of 1 Hz is obtained by counting down from a typical 4.194-MHz oscillator or a 32.768-kHz oscillator using the appropriate number of binary stages.

Device Selection

Although the binary counter has advantages, it does have the handicap of interfacing a non-binary world. It is difficult to decode accurately a non-binary count from a binary counter because a complex decoding scheme is needed and because the possibility of decoding spikes is increased. As shown in Fig. 8, a binary counter needs many external gates for decoding purposes. In addition, to change

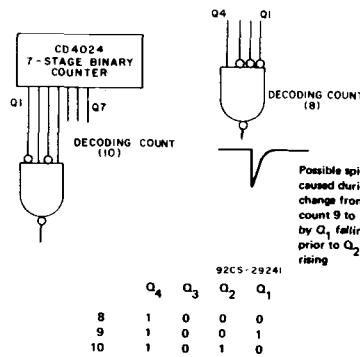

Fig. 8 - Typical external gate required by binary counter for decoding; spike possibility caused by non-simultaneous bit change, and, counting sequence requiring simultaneous bit change.

from count 9 to count 10, two bits must change simultaneously. Consequently, if one bit changes prior to the second, a false count of 8 or 11 could be decoded.

To avoid this kind of "glitch" possibility the Johnson counter was designed. In the Johnson counter only one

bit is changing at a time, as shown in Fig. 9. Decoding of the Johnson counter with one inverter and one two-input gate can always be accomplished by decoding a 1;0 or 0;1 state between the two appropriate outputs. In addition, because only one bit is changing when the counter moves from one count to the next, no decoding glitches will develop from this decoding network.

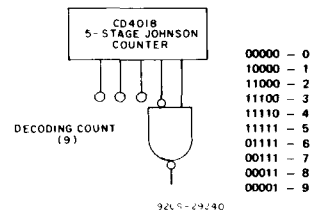

Fig. 9 - External gate required by Johnson counter; counting sequence requiring only one bit change at a time.

One disadvantage of both the binary and the Johnson counters is the difficulty of interfacing a decimal world. This difficulty instigated the development of the binary-coded decimal system. In the BCD system, by grouping four bits into each single decimal number, the actual count becomes much easier for human interface.

By way of summary, binary counters, because of their high information density, low power consumption, and relative simplicity, are well suited for applications such as industrial timers, watch or clock operation, binary arithmetic systems, and microprocessor systems.

Johnson counters, because of their decoding ease for any given count, are well suited for industrial controls, sequencers, low divide-by-n decoding, and programmable divide-by-n counters.

BCD counters, because of their ease of interface for human control, are well suited for programmable divide-by-n counters, counting systems for seven-segment readouts, industrial controls, and frequency synthesis.

# Understanding Buffered and Unbuffered CMOS Characteristics

by R. E. Funk

## INTRODUCTION

Both buffered and unbuffered CMOS B-series gates, inverters, and high-current IC products are available from RCA; each product classification has application advantages in appropriate logic-system designs. Recently, many CMOS suppliers have been concentrating on promoting buffered B-series products with applications literature focusing on the attributes and use of the buffered types. This practice has left an imbalance in the understanding and application of both buffered and unbuffered gates and, in many instances, customers are not using unbuffered products when they are the best for the intended application. This Note narrows the misunderstandings involved in this issue by presenting and discussing the relative merits of the buffered and unbuffered CMOS devices.

## Background

Historically, most CMOS gates, inverters, and high-current IC products were unbuffered, and exhibited good logic-system performance, speed, noise immunity, and quasi-linear characteristics in a wide variety of applications. As the scope of CMOS products broadened and more manufacturers entered the scene, buffered gate and inverter products were brought out by RCA and others. While RCA confined initial buffered products to new OR and AND functions, other manufacturers introduced buffered NOR and NAND gates having the same generic 4000A-series designations as the original widely-used unbuffered gates. Many users were surprised by the non-interchangeability of the devices in applications where speed, noise immunity, output impedance, and linear gain-bandwidth characteristics were critical. It is of immense benefit to CMOS users to have available the definitions and designations of both buffered and unbuffered B-series CMOS devices as determined by the JEDEC CMOS Standardizing Committee under the cognizance of the JC40.2 JEDEC Committee of EIA. The official JEDEC definitions are repeated below along with detailed explanations and examples. Comparison of user-oriented characteristics and the use of buffered and unbuffered gates are also reviewed.

## Definitions

**Buffered CMOS**—A CMOS device for which the output on impedance is independent of any and all valid input logic conditions, both preceding and present, is said to have a buffered output or to be a buffered CMOS device. All such products are designated by the suffix B.

**Unbuffered CMOS**—Products that meet B-series specifications except that the logical outputs are not buffered and the  $V_{IL}$  and  $V_{IH}$  specifications are 20 percent and 80 percent of  $V_{DD}$ , respectively, are marked with

the UB designation, such as (including, but not limited to):

4000UB	4025UB
4001UB	4007UB
4002UB	4009UB
4011UB	4041UB
4012UB	4049UB
4023UB	4069UB

The official JEDEC definitions are primarily applicable to gates, inverters, and high-current (inverting) drivers such as the specific UB types shown above. Non-inverting gates and drivers as well as all MSI and LSI B-types are by definition B types. There are special analog I/O types that are also included as B types since they conform to all B standards except that they have special analog I/O circuitry. Examples of parts that have no buffered or unbuffered significance are:

4016B	4053B
4046B	4067B
4051B	4097B
4052B	4066B
	4511B
	4528B

RCA will make available both types of CMOS gates. Logic examples of the buffered

and unbuffered 2-input NOR gate are shown in Fig. 1. Note that the buffered logic can be implemented by either a 2-input NOR function followed by two inverters or by two input inverters followed by the 2-input NAND gate and an output buffer. RCA uses the latter logic configuration, which has the advantage of optimizing device noise immunity by negating the effect of stacked devices at the input. This characteristic is

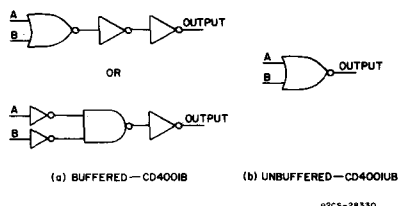

Fig. 1 — Examples of the buffered (CD4001B) and unbuffered (CD4001UB) 2-input NOR gate.

especially significant for 3- or 4-input gates where three or four PMOS or NMOS transistors are stacked in series at the input. In this case, the inputs have an effective offset in threshold and reduced input noise immunity.

Fig. 2 is a schematic representation of the RCA buffered and unbuffered 2-input NOR gates. The improved 4-diode-input gate-oxide protection circuit is shown at the inputs.

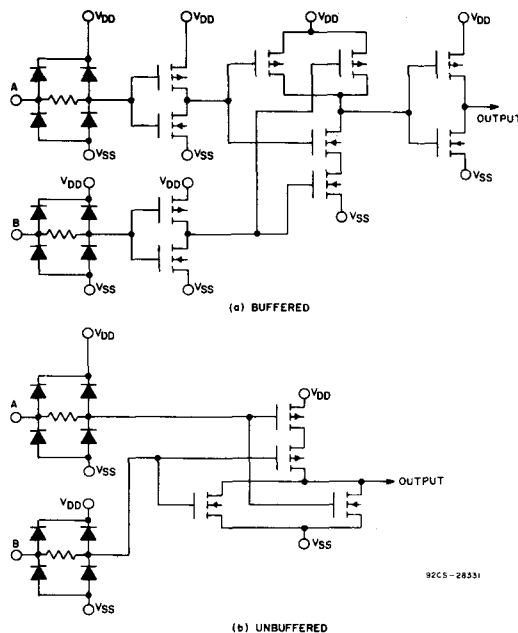

Fig. 2 — Schematic diagrams of the buffered and the unbuffered 2-input NOR gate.

**Examples**

Examination of the dc performance characteristics of both the buffered and unbuffered 2-input NOR gate reveals the two electrical characteristics, output impedance and noise immunity, by which the types are differentiated by the JEDEC standard specifications:

**Output Impedance**

**—Buffered—**Fig. 3 depicts the buffered output stage and shows the MOS transistor as switched on with a channel resistance  $R$ ;  $R$  is the same value for the n-switch closed or the p-switch closed.

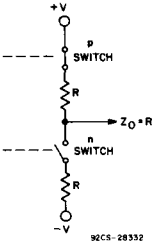

Fig. 3 — Constant output impedance of a buffered gate.

**—Unbuffered—**Fig. 4 depicts the unbuffered 2-input-gate p- and n-channel MOS switches and appropriate on-channel resistances. Note that the two stacked p-channel switches are designed for an on resistance of  $R/2$ , so that the output impedance is  $R$  when both the logic inputs are low, Fig. 4(b). In Fig. 4(a) the output impedance is  $R$  to the negative supply terminal (usually ground) for an input logic state of 1, input high. Fig. 4(c) shows the condition when the unbuffered gate has an output impedance of  $R/2$  for both logic inputs high. Hence the variable output impedance of the unbuffered gate. For a 4-input gate, this variable is  $R$  to  $R/4$ ! The maximum output resistance of RCA buffered or unbuffered gates is  $R$ . Thus, minimum  $I_{OL}$  and  $I_{OH}$  specifications for buffered and unbuffered gates are identical.

**Noise Immunity**

The second JEDEC-defined difference between the buffered and unbuffered CMOS gates (or inverters) is the difference in input noise-immunity characteristics.

**—Buffered—**The buffered 2-input NOR gate voltage-transfer characteristics, Fig. 5, are squared because of the gain of three CMOS stages from input to output. Fig. 5 shows that noise voltage inputs of  $\pm 1.5$  V at  $V_{DD} = 5$  V and  $\pm 4$  V at  $V_{DD} = 15$  V will have little discernible

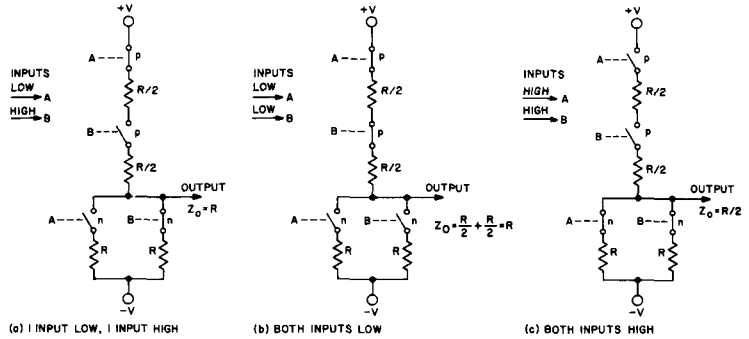

Fig. 4 — Variable output impedance of an unbuffered 2-input NOR gate. The resistors represent the on impedance of a p- or n-channel MOS transistor.

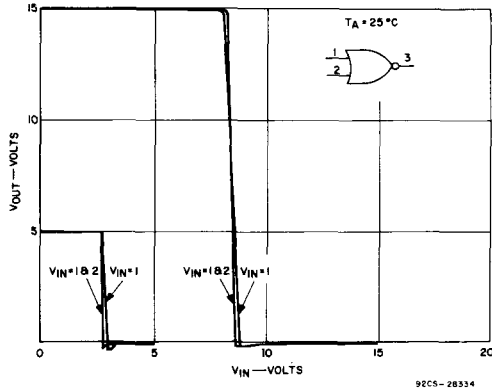

Fig. 5 — Voltage transfer characteristics of a buffered 2-input NOR gate (CD4001B).

effect on the output voltage; i.e., noise immunity for all logic states is optimally high as is noise margin: 1 volt at  $V_{DD} = 5$  V and 2.5 V at  $V_{DD} = 15$  V.

**—Unbuffered—**Fig. 6 shows the rounded voltage-transfer characteristics of the 2-input unbuffered NOR gate. Also evident is the shift in the transfer curve for the different logic input states. Compare these curves to those of Fig. 5 and the effects of the non-buffered inputs as well as the gain differences are evident. The rounded characteristics require a noise-immunity specification of  $\pm 20\%$  of  $V_{DD}$  at 5, 10 and 15 V as well as a reduced noise margin: 0.5 V at  $V_{DD} = 5$  V and 1.0 V at  $V_{DD} = 15$  V.

The above definitions use gate characteristics as illustrative of the JEDEC definitions for buffered and unbuffered characteristics relative to variable output impedance and noise-immunity performance. Inverters and high-current drivers may also be defined

as buffered (B) types or unbuffered (UB) types by virtue of the squared or rounded transfer characteristics of Figs. 3 and 4, respectively. Even though both types have a single NMOS and single PMOS output transistor, the rounded transfer characteristic of the unbuffered inverters makes them UB types by virtue of:

1. Reduced noise-immunity performance where the 20% rating is applicable.
2. Varying output impedance as a function of input voltage change along the rounded portion of the transfer curve.

**COMPARISONS**

Table I shows the qualitative comparisons of user-oriented performance characteristics of buffered and unbuffered CMOS gates, inverters, or drivers. Table II is a quantitative comparison of the key performance characteristics with explanations as follows:

**Propagation Delay—**Delays shown are applicable to RCA 2-, 3-, and 4-input NOR and NAND gates.

# ICAN-6558

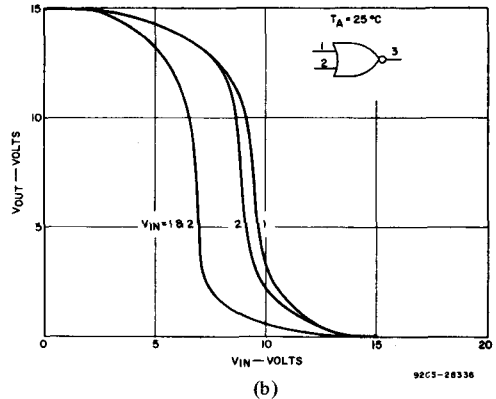
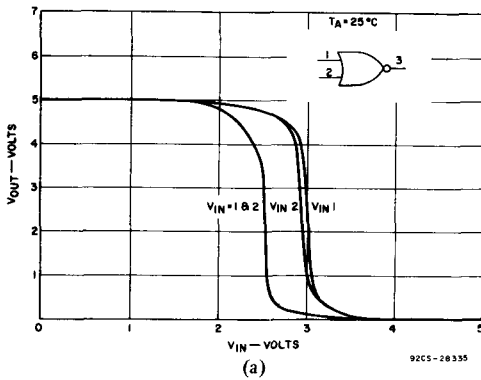

Fig. 6 - Voltage transfer characteristics of an unbuffered 2-input NOR gate (CD4001UB) with output voltages of 5 and 15 volts.

Table I—Comparison of Buffered and Unbuffered Gate Characteristics

Characteristic	Buffered	Unbuffered
Propagation Delay	Slow	Fast
Noise Immunity/Margin	Excellent	Good
Output Impedance and Output Transition Time	Constant	Variable
AC Gain	High	Low
Output Oscillation for Slow Inputs	Yes	No
Input Capacitance	Low	High

**Noise Immunity**—Table III shows the detailed input-voltage data-sheet specifications for buffered and unbuffered gates. From these test conditions the user-oriented noise-immunity and noise-margin data of Table II are derived. Also refer to Figs. 5 and 6 for the voltage-transfer characteristics that illustrate the reason for the different input-voltage-specification requirements for buffered and unbuffered devices.

**Output Impedance**—Refer to Figs. 3 and 4 and accompanying descriptions of the constant output impedance of buffered gates and the variable output impedance of unbuffered gates. Note that both buffered and unbuffered RCA 2-, 3- and 4-input gates are designed to meet the same maximum output impedance; output current ratings ( $I_{OL}$  and  $I_{OH}$ ) have the same minimum limit on RCA data sheets.

**Output Transition Time**—The time required for a CMOS output to transfer high or transfer low is constant for buffered gates but varies according to input logic states for unbuffered gates. Output transition time varies as a function of the driving source resistance of

Table II—Characteristics of Buffered and Unbuffered Gates

	Buffered Gates	Unbuffered Gates
Typical Propagation Delay $V_{DD} = 5\text{ V}, C_L = 50\text{ pF}$	150 ns	60 ns
$V_{DD} = 10\text{ V}$	65 ns	30 ns
$V_{DD} = 15\text{ V}$	50 ns	25 ns
Noise Immunity	30% of $V_{DD}$ at 5 and 10 V 27% at 15 V	20% of $V_{DD}$ at 5, 10, and 15 V
Noise Margin $V_{DD} = 5\text{ V}$	1 V	0.5 V
$10\text{ V}$	2 V	1.0 V
$15\text{ V}$	2.5 V	1.0 V
Typical Output Impedance $V_{DD} = 5\text{ V}, V_O = \pm 0.4\text{ V}$		
2-Input Gate	400 ohms	200-400 ohms
3-Input Gate	400 ohms	133-400 ohms
4-Input Gate	400 ohms	100-400 ohms
Typical Output Transition Time $V_{DD} = 5\text{ V}, C_L = 50\text{ pF}$ (2-, 3-, 4-Input Gates)	100 ns	50-100 ns
AC Gain $V_{DD} = 10\text{ V}$	$\approx 68\text{ dB}$	$\approx 23\text{ dB}$
AC Bandwidth $V_{DD} = 10\text{ V}$	280 kHz	885 kHz
Output Oscillation For Slow Inputs	Susceptible For $t_r, t_f > 1\text{ ms}$	Not Susceptible For $t_r, t_f$ to 100 ms
Typical Input Capacitance		
Average	1-2 pF	2-3 pF
Peak	2-4 pF	5-10 pF

the output, which is state dependent as indicated in Fig. 4, as well as the device output capacitance, which is dependent on both device size and input logic state. Because of variable output capacitance, output-transition-time variations are not a linear

function of output resistance. As Table II shows, RCA 2-, 3- and 4-input unbuffered gates exhibit a net 2-to-1 difference in output transition time even though the output resistance has a net 4-to-1 variation for the 4-input gate.

Table III—Input-Voltage Specifications

Characteristic	V <sub>O</sub>	V <sub>DD</sub>	Limit		Units
			Min.	Max.	
Input Voltage Low (V <sub>IL</sub> )	4.5	5	—	1.5	Volts
		9	—	3	
		13.5	—	4	
	UB	4.5	—	1	
		9	—	2	
		13.5	—	2.5	
Input Voltage High (V <sub>IH</sub> )	0.5	5	3.5	—	
		1	—	7	
		15	—	11	
	B	0.5	—	4	
		1	—	8	
		1.5	—	12.5	

Notes:

- Noise-immunity voltage is the V<sub>IL</sub> or V<sub>IH</sub> Specification Limit.
- Noise-margin voltage is computed as follows:

$$\begin{aligned} \text{Noise-Margin Voltage} &= V_{IL} - (V_{DD} - V_O) \\ &= (V_{DD} - V_{IH}) - V_O \end{aligned}$$

**AC Gain and Bandwidth**—CMOS linear-mode gain was measured for both the buffered and unbuffered RCA 2-input NOR gate by means of the test circuit of Fig. 7. Fig. 8 shows typical linear-mode gain difference between buffered and unbuffered RCA 2-input NOR gates. While absolute performance depends on device type (inverters; 2-, 3-, 4-input gates) and test configurations, Fig. 8 defines the

approximately 3-to-1 difference in linear-mode performance between buffered and unbuffered gates.

**Output Oscillation for Slow Inputs**—The high linear-mode gain of buffered CMOS devices can lead to undesirable oscillation at outputs when input ramps are in excess of approximately 1 millisecond duration. Fig. 9 illus-

and therefore increases the effective average input capacitance. Buffered gates and inverters are rated at a maximum input capacitance of 1 unit load (7.5 picofarads—JEDEC standard); unbuffered gates and inverters are rated at 2 unit loads (15 picofarads maximum). High-current unbuffered drivers, such as the CD-4049UB, are rated at 3 unit loads (22.5 picofarads maximum).

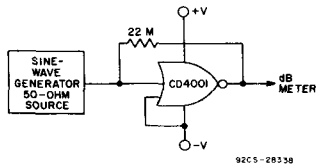

Fig. 7 — Linear-gain test circuit.

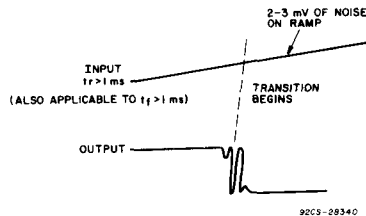

Fig. 9 — Buffered output oscillation for a slow input.

trates this effect when approximately 1 to 2 millivolts of ac noise within the device bandwidth on the input signal are amplified through the device and tend to develop a few cycles of oscillation between the positive and negative rails under 5-volt operation. In contrast, unbuffered gates do not tend to oscillate unless a noise voltage of 200 to 300 millivolts were present within the bandwidth of the device. An input ramp of up to 100 milliseconds duration did not create oscillation in laboratory tests of RCA unbuffered gates.

**Input Capacitance**—Figs. 10 and 11 show the dynamic input capacitance of the RCA buffered and unbuffered 2-input NOR gates, respectively. The large MOS transistor geometry of the unbuffered NOR gate is responsible for the higher peak input capacitance (Miller effect) in the linear switching range. The longer dwell in this linear region also tends to broaden the Miller capacitance,

Applications Guidance

Table IV summarizes preferred application areas for both buffered and unbuffered RCA B-series IC products. This information is based on the buffered and unbuffered CMOS device characteristics listed in Table II combined with the author's experience and familiarity with the application areas indicated. The information given is general guidance to allow the designer to key in on the specific performance characteristics of either device type. The data provided in this Note are derived from RCA standardized B and UB products whose circuit designs were implemented to match performance between UB and B gate types as closely as possible. For example, device sizes were selected to assure matched output drive. In addition, the process and layout rules followed in B and UB designs of RCA product are identical, as is the use of improved gate-oxide protection circuitry for B and UB product.

RCA Gate, Inverter, and Driver Products

Table V is a current list of SSI (small scale integrated) B and UB products presently in production by RCA. Refer to RCA product guides and the Databooks for detailed product information.<sup>1</sup>

References

- COS/MOS Digital Integrated Circuits, Product Guide, COS-278E, 1976.  
RCA Integrated Circuits, Databook, SSD-210, 1976.

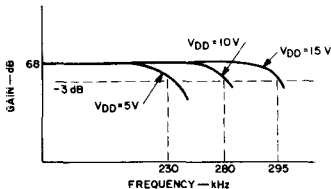

(a) TYPICAL CD4001B LINEAR GAIN

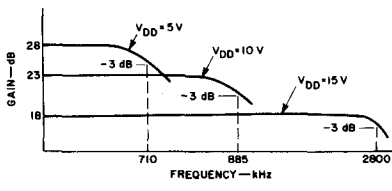

(b) TYPICAL CD4001UB LINEAR GAIN

Fig. 8 — Typical linear-mode gain of buffered and unbuffered 2-input NOR gate.

# ICAN-6558

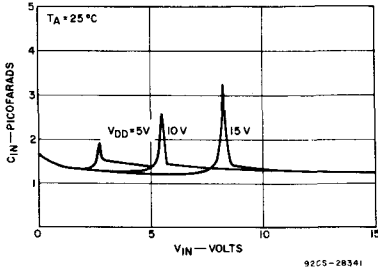

Fig. 10 — Input capacitance of a buffered 2-input NOR gate (CD4001B).

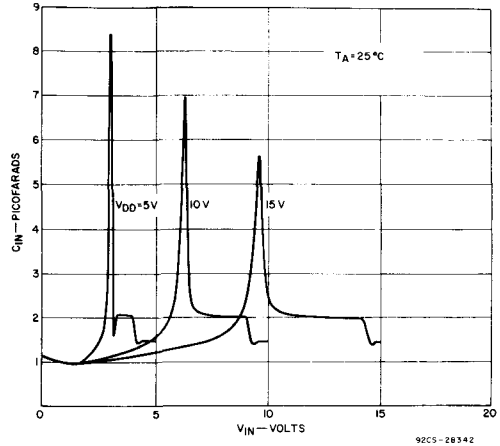

Fig. 11 — Input capacitance of an unbuffered 2-input NOR gate (CD4001UB).

Table IV—Applications of Buffered and Unbuffered CMOS Gates and Inverters

Application	Buffered	Unbuffered
High-Speed Systems	—	Preferred
High-Noise Environments, Low-Speed Systems	Preferred	—
Ultra-Low-Frequency Systems Inputs <1 kHz sine wave or ramps with $t_r, t_f > 1$ ms* excluding Schmitt Triggers	—	Preferred
Gate Applications Requiring Constant Output Impedance Such as D/A R-2R Conversion	Preferred	—
High-Freq., Moderate Gain, Linear Amplification	—	Preferred
Low-Freq., High Gain, Linear Amplification	Preferred	—

\* Applies to gates of inverter designs of Astable or Monostable multivibrators with  $T > 1$  millisecond.

Table V—RCA COS/MOS Buffered and Unbuffered Gate, Inverter, and Driver Types

Buffered	Unbuffered
CD4000B	CD4000UB
CD4001B	CD4001UB
CD4002B	CD4002UB
CD4010B	CD4007UB
CD4011B	CD4009UB
CD4012B	CD4011UB
CD4023B	CD4012UB
CD4025B	CD4023UB
CD4050B	CD4025UB
CD4068B	CD4041UB
CD4071B	CD4049UB
CD4072B	CD4069UB
CD4073B	
CD4075B	
CD4078B	
CD4081B	
CD4082B	

# Radiation Resistance of the COS/MOS CD4000A and CD4000B Series

by M. N. Vincoff

Complementary MOS (COS/MOS) integrated circuits possess many advantages which recommend their use in radiation-susceptible space and military environments. Several of the most significant of these advantages are: ultra-low standby-power consumption, high noise immunity,<sup>1</sup> extremely high packaging density, and inherently high reliability.<sup>2,3</sup> These advantages, along with the improved radiation resistance of the 1975 and 1976 RCA CD4000A and CD4000B series over the previous CD4000 and CD4000A series described in earlier radiation studies,<sup>4</sup> exhibit the maturity reached by the MOS technology since 1969.

A number of studies of the radiation resistance of complementary MOS devices by JPL, NASA, NRL and various companies in the space industry have revealed two areas of prime concern.<sup>5, 6</sup> The first, permanent radiation exposure, as experienced in a space-satellite environment, causes a shift in threshold or switching voltage, which could result in increased leakage current,  $I_L$ . The second, transient radiation exposure, as experienced in an atomic environment, causes the output-voltage levels to respond to a pulse of ionizing radiation; this effect could change the state of the logic circuitry and require resetting of that circuitry for proper equipment or system operation.

### Permanent-Radiation Resistance

The CD4000 series was resistant to permanent radiation levels of  $2 \times 10^4$  rads (approximately  $10^{12} \text{ e/cm}^2$ ) in 1971 and 1972. In 1973, the RCA CD4000A-series devices without special processing were found to be resistant to radiation levels up to  $2 \times 10^5$  rads (approximately  $10^{13} \text{ e/cm}^2$ ), as shown in Fig. 1.<sup>4</sup> In this figure the change in switching voltage  $V_S$  was plotted as a function of dose; the value of  $V_S$  was calculated from the average value of  $V_{TN}$  and  $V_{TP}$  for the devices mentioned. In 1974 a minor change was made to the process and the radiation resistance was reduced to the 1971 - 1972 level. In late 1974 and early 1975 a JPL/NASA contract study resulted in a second change to the process (gate-oxide area); the change achieved a repeated radiation-resistance level of  $1 \times 10^5$  rads (Si). This level of radiation resistance is presently provided on Class A parts having a "Z" designation after the part number.

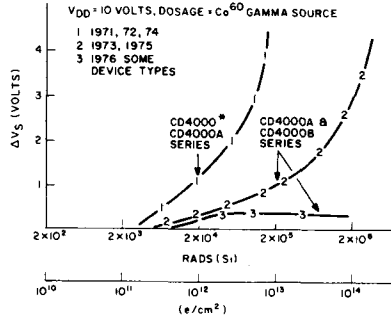

\* POSITIVE BIAS APPLIED 100% OF THE TIME 92CS-22496R1

Fig. 1 - Permanent radiation resistance of CD4000, CD4000A- and CD4000B-series devices.

Product with this designation is tested on a lot-sampling basis using a Gamacell-200 Co-60 radiation source. Latest radiation-process improvements and resultant production studies indicate that some 1976 product exhibits radiation-resistance levels up to and beyond  $1 \times 10^6$  rads (Si). RCA expects to have production CD4000A and B series product available to  $1 \times 10^6$  rads (Si) in 1977.

The new radiation level of the CD4000A and B series represents a significant improvement over the previous CD4000A series. In addition, with minimal shielding (for example, 1/16-inch of aluminum) the CD4000A or B series can be used in applications with levels of radiation up to  $2 \times 10^6$  rads (approximately  $10^{14} \text{ e/cm}^2$ ).

### Transient-Radiation Resistance

The resistance of the latest CD4000A and B series (1975 and 1976) to transient radiation is expected to be better than that of the past CD4000A series, which should withstand pulses of radiation in the range of approximately  $10^9$  to  $10^{10}$  rads/s.<sup>7</sup>

### Design Considerations

The resistance of the CD4000A- and B-series devices to either permanent- or transient-radiation exposure can be increased by providing either minimal shielding in the equipment enclosure containing the devices or by locating the devices deep within the equipment. In any case, the action taken will depend on the constraints dictated by the radiation environment imposed by the system or program. Each application must be tested and the results analyzed with the

data in this Note as criteria. Test items to be considered are radiation environment, which will vary greatly depending on dosage rate; time of exposure; amount of normal shielding; distance of the device from the radiation source; shielding afforded by the atmosphere; power-supply voltage selection; and switching cycles used during exposure. For example, consider the effects of permanent radiation on two spacecraft in 90-degree orbits at 600 and 1500 nautical miles from the earth, respectively. The dose-depth is determined as shown in the curves of Fig. 2.

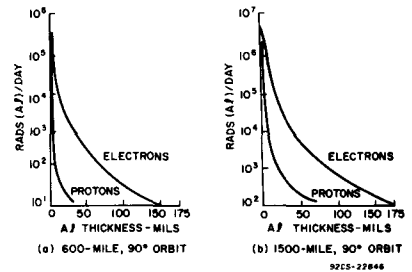

Fig. 2 - Dose-depth curves for trapped electrons and protons in spacecraft in orbit.

In these curves the dose in rads (A1)/day is plotted as a function of the thickness of spacecraft aluminum required to shield the devices from trapped electrons and protons.<sup>5</sup>

### Conclusion

The RCA COS/MOS CD4000A and B series exhibit improved radiation resistance over the previous CD4000A series, and operate well in many applications in which permanent and transient radiation effects are factors. When stringent radiation requirements are imposed, additional shielding can be employed to increase the radiation life of COS/MOS CD4000A- or B-series devices to any desired level, i.e., to make their radiation resistance equivalent to that of bipolar devices.<sup>6,8</sup>

### Reference

1. Eaton, S.S., "Noise Immunity of RCA COS/MOS Integrated Circuit Logic Gates", RCA Application Note ICAN-6166.
2. Vincoff, M.N. and Schnable, G.L., "COS/MOS is a High-Reliability Technology", RCA Technical Publication ST-6112.
3. M.N. Vincoff and G.L. Schnable, "Reliability of Complementary MOS Integrated Circuits," IEEE Transactions on Reliability, R-24, pp 255-259 (Oct. 1975).

---

## ICAN-6563

4. Ezzard, G., "Radiation Effects on COS/MOS Devices", RCA Application Note ICAN-6604 (covers CD4000 series).
5. Brucker, G.J., "COS/MOS Device Sensitivity in Outer-Space Radiation Environment", Report No. X72002, Oct. 17, 1973, RCA Astro Electronics Division.
6. E. M. Reiss, "Radiation-Hardened CMOS", for presentation at the 1976 Government Microcircuits Application Conference.
7. Dennehy, W.J., et al., "Transient Radiation Response in Complementary-Symmetry MOS Integrated Circuits", RCA Technical Publication ST-4308.
8. Smith, J.M., and Murray, L.A., "Radiation Resistant COS/MOS Devices", RCA Technical Publication ST-4723.
9. Poch, W.J., and Holmes-Siedle, A.G., "Permanent Radiation Effects in COS/MOS Integrated Circuits", RCA Technical Publication ST-4174 (covers CD4000 series).
10. Schambeck, W., "Radiation Resistance and Typical Applications of RCA COS/MOS Circuits in Spacecrafts", Telemetry Journal, June/July 1970 (covers CD4000 series).
11. Schambeck, W., "Effects of Ionizing Radiation on Low-Threshold C-MOS Integrated Circuits", DFVLR Institute for Satellite Electronics, Oberpfaffenhofen, W. Germany, April 1972 (covers CD4000A series).
12. Danchenko, V., "Radiation Damage in MOS Integrated Circuits, Part I", Sept. 1971, Goodard Space Flight Center, Report X-711-71-410 (covers CD4000A series).
13. Poch, W.J., and Holmes-Siedle, A.G., "The Long-Term Effects of Radiation on Complementary MOS Logic Networks", IEEE Transactions on Nuclear Science NS-17 (6), Dec. 1970 (covers CD4000 series).
14. King, E.E., Nelson, G.P., and Hughes, H.L., "The Effects of Ionizing Radiation on Various COS/MOS Integrated Circuit Structures", IEEE Transactions in Nuclear Science, No. 6, pp. 264, Dec. 1972, RCA Technical Publication ST-6161.
15. Peel, John L., et al., "Radiation-Hardened Complementary MOS Using SiO<sub>2</sub> Gate Insulators", IEEE Transactions on Nuclear Science, No. 6, pp. 271, Dec. 1972.
16. Schlesier, K.M., et al., "COS/MOS Hardening Techniques", IEEE Transactions on Nuclear Science, No. 6, pp. 275, Dec. 1972.
17. E.M. Reiss and M.N. Vincoff, "Effects of Variation of Gate Oxide Anneal Temperature on Radiation Resistance and Reliability of CMOS Devices", presented at the Conference on Nuclear and Space Radiation Effects, Humbolt State College, Arcata, California July 14-17, 1975, Conference Summary, pp. 349-353 (1975).



# Applications of CD40107BE

## COS/MOS Dual NAND Buffer

by D. J. Blandford and G. L. Gimber

This Note describes the characteristics of the COS/MOS dual NAND buffer, the CD40107BE, and the wide variety of practical applications in which this important addition to the CD4000-series of COS/MOS devices can be used.

### CHARACTERISTICS

Fig. 1 shows the logic diagram of the CD40107BE, which consists of two 2-input NAND buffers in an eight-pin plastic pack-

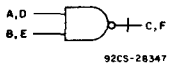

Fig. 1 - Logic diagram of the CD40107BE NAND buffer.

age; pin assignments are shown in Fig. 2. The bar on the output line of the logic diagram in Fig. 1 indicates that the output

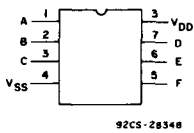
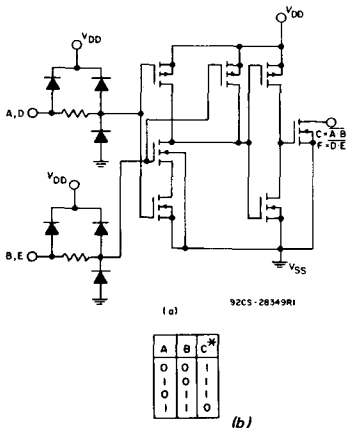

Fig. 2 - Pin assignments of the CD40107BE.

is open-drain, as shown in Fig. 3, the circuit diagram and truth table for a single buffer.



\* REQUIRES EXTERNAL PULL-UP RESISTOR TO VDD 92CS-28350

Fig. 3 - (a) Circuit diagram of the CD40107BE, (b) truth table for 1 of 2 gates.

Each input includes the standard COS/MOS protection network, a 1.5 kilohm input resistor and diodes to VDD and VSS. The output device is a large n-channel transistor. Typical transistor sink-current characteristics are shown in Fig. 4 in which drain current, IDN, is plotted against drain-to-source voltage, VDS, for VGS = 5 V, 10 V and 15 V (i.e., VDD = 5 V, 10 V, and 15 V). Note, for example, that for a VDS of 1 volt and a 10-volt supply, the NAND buffer is capable of sinking typically 120 milliamperes. Applications of this large current-sinking capability are described below.

A pull-up resistor from the output (pins 3 or 5) to VDD enables the device to perform the logical NAND function, as shown in the truth table, Fig. 3(b). Useable values

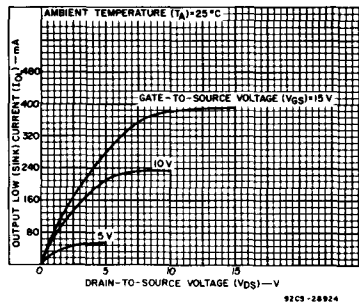

Fig. 4 - Minimum output low (sink) current characteristics of the CD40107BE.

of pull-up resistance lie between approximately 100 ohms and 1 megohm. Care should be taken when choosing a pull-up resistor or any other load not to exceed the maximum power dissipation of the device. Designers should refer to the device data sheet for allowable dissipation limits over the desired temperature range.

The three stages of gain from input to output of the CD40107BE, Fig. 3(a) result in a very sharp transfer characteristic, Fig. 5, near the ideal for a digital logic device. More complete characteristics are given in the CD40107B data sheet.<sup>1</sup>

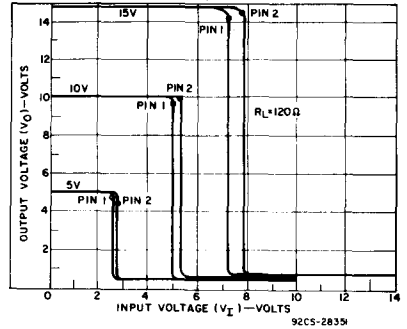

Fig. 5 - Transfer characteristics of the CD40107BE showing source-bias effect.

### PRACTICAL APPLICATIONS

Practical applications of the CD40107BE overlap with those of other devices in the COS/MOS CD4000 series, for example, with the logical NAND function of the CD4011 and with the buffer function of the CD4041, CD4049, and CD4050. However, the applications described in this Note are those for which, until now, no COS/MOS NAND buffer has had sufficient drive capability, in the hundred milliampere range.

In the first of these applications, Fig. 6, two NAND buffers are each driving a 2.2-watt, 12-volt incandescent lamp. The circuit is arranged as an astable oscillator with its period of approximately two seconds determined by the external capacitor and resistors. In this and other similar applications the load is used as a pull-up from the open-drain output to a power-supply voltage greater than zero and equal to or less than VDD.

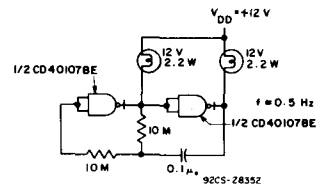

Fig. 6 - A 2.2-watt incandescent lamp-driver circuit.

# ICAN-6564

The same type of astable circuit is shown in Fig. 7, but with a single load device, an LED with a current limiting resistor of 150 ohms. The NAND buffer, as well as driving the load, forms part of the astable circuit, with one of its inputs used as an enable; when this input is low, the LED is permanently off. The other half of the astable oscillator utilizes a two-input NOR gate, the CD4001AE, one input of which is used as an inhibit. With the timing components shown, the astable frequency is approximately 4 Hz.

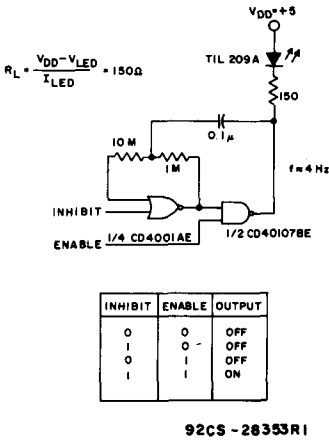

Fig. 7 - LED driver circuit.

The NAND buffer is typically capable of sinking 120 milliamperes at a  $V_{DS}$  of 1 volt with a 10-volt supply. It therefore meets the typical requirements for the current-sinking device at the cathode terminal of a common-cathode LED multiplexed display circuit, Fig. 8. In this display circuit, data is presented in the form of four BCD numbers to be displayed on the four seven-segment LED's; the clock input determines the multiplexing rate. The two D-type flip flops of the CD4013AE or BE are arranged as a two-stage Johnson counter, the two Q outputs of which select the data transferred by the CD4052BE multiplexers to the CD4511BE decoder-driver. The same Q outputs are decoded by the four NAND buffers and used to turn on the seven-segment displays in the correct sequence. For example, when  $Q1 = 1$  and  $Q2 = 0$ , both inputs of the NAND buffer marked B in Fig. 8 are high, and the buffer sinks current through the diodes of the second seven-segment display digit.

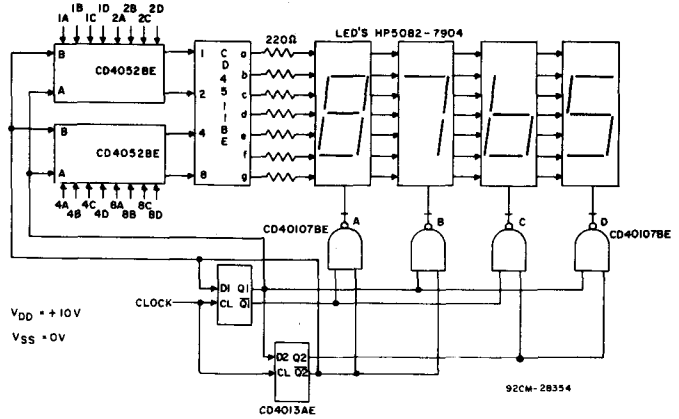

Fig. 8 - Multiplexed LED circuit.

By using the two NAND buffers of a single eight-pin DIP in parallel, it is possible to interface directly from a COS/MOS system to a heavy-duty load typified by the computer peripheral-printer hammer solenoid of Fig. 9. This type of solenoid typically requires 250 milliamperes to turn on which, at a supply voltage,  $V_{DD}$ , of 12 volts, implies a  $V_{DS}$  of approximately 0.6 volt. To prevent excessive current flow through the electrostatic-protection diodes to  $V_{DD}$  at the outputs of the NAND buffers, in applications such as the one under discussion, the switching of inductive loads, the protection diodes should be shunted with a low-dynamic-impedance switching diode, such as a 1N4154.

In many systems where COS/MOS devices are used for their wide operating-voltage

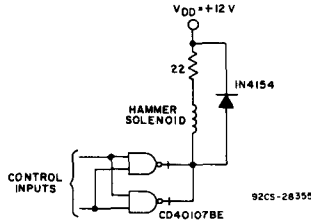

Fig. 9 - Solenoid driver circuit.

range and high noise immunity, and particularly in industrial control applications, it is important to be able to drive relays directly. Fig. 10 shows a NAND buffer driving a

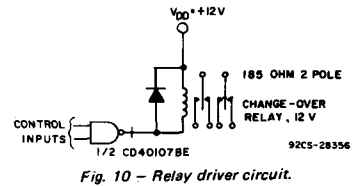
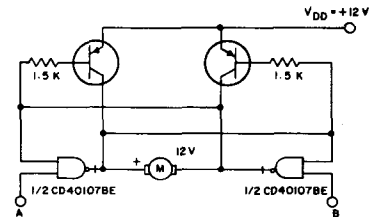

Fig. 10 - Relay driver circuit.

common type of 12-volt relay, a two-pole change-over type with a coil resistance of 185 ohms. Again, a 1N4154 shunt diode is advisable.

Fig. 11 shows a reversible 12-volt tape-recorder motor driven by two NAND buffers in a bridge circuit. Two p-n-p transistors provide an active pull-up to  $V_{DD}$ .

SCR's and triacs typically require tens of milliamperes of gate current, more than the current capability of a standard COS/MOS device output. The NAND buffer, however, is able to sink sufficient current, and in



A	B	MOTOR FUNCTION
0	0	OFF
1	0	COUNTER CLOCKWISE AS PREVIOUS STATE
0	1	CLOCKWISE AS PREVIOUS STATE
1	1	AS PREVIOUS STATE

92CS-28357

Fig. 11 - Motor-controller circuit.

Fig. 12 is seen driving a 2N5756 triac. If isolation is required between the COS/MOS

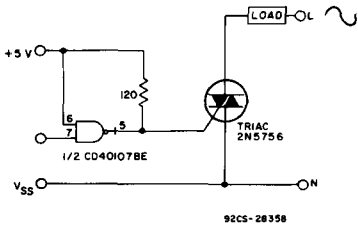

Fig. 12 - Direct dc drive interface of CD40107BE with a triac.

and triac systems, the circuit of Fig. 13 is used. In the figure, the NAND-buffer load is the primary coil of a pulse transformer

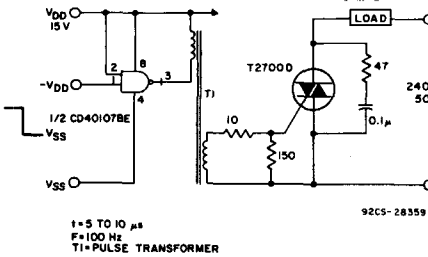

Fig. 13 - Interface of CD40107BE with triac, with COS/MOS component and triac isolated.

$T_1$ , and when 5- to 10-microsecond pulses are applied at a 100-Hz repetition rate to the COS/MOS input, sufficient current flows in the transformer secondary to keep the triac, a T2700D, turned on. The NAND-buffer circuits make it possible for a COS/MOS system to control several amperes of current at line voltage.

Line driving is another application requiring large current pulses; Fig. 14 shows two NAND buffers driving a twisted-pair transmission line. Clock rates up to 8 MHz are readily achieved by circuits driving five meters of a 130-ohm line twisted at two turns per inch.

One of the most important applications for the open-drain NAND buffer is the

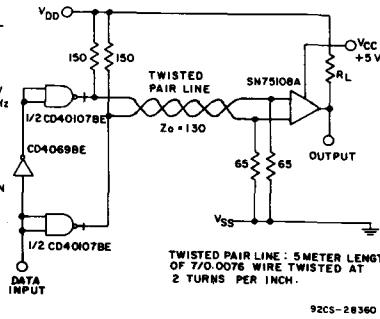

Fig. 14 - Line-driver circuit.

COS/MOS to TTL interface shown in Fig. 15. The  $V_{DD}$  pin of the CD40107BE is connected to the power supply of the COS/MOS system, the external pull-up resistor to the 5-volt TTL supply. The values of the pull-up resistor required and the number of loads that may be driven are shown in the table accompanying Fig. 15.

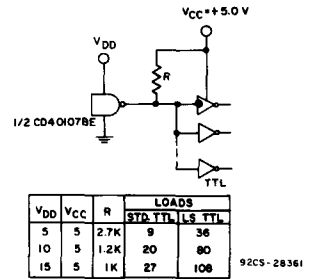

Fig. 15 - COS/MOS to TTL interface.

$V_{DD}$	$V_{CC}$	R	LOADS		
			STD. TTL	LS	TTL
5	5	2.7K	9	36	
10	5	1.2K	20	80	
15	5	1K	27	108	

References

1. Preliminary Data Sheet for the CD40107BE, COS/MOS Dual 2-Input NAND Buffer/Driver, 1976; or RCA Databook, Series SSD-210, 1976.

# ICAN-6572

## COS/MOS Electrostatic-Discharge Protection Networks

by H. L. Pujol

RCA's two families of CMOS devices, the standard A series (3 to 15 volts) and the high-voltage B series (3 to 20 volts), are equipped with networks to protect the gate oxide of the devices against damage resulting from discharge of electrostatic energy between any two pins.

The gate input of a CMOS device is equivalent to a small, low-leakage capacitor (typically 5 picofarads) in parallel with a very high resistance (typically  $10^{12}$  ohms). Because of this extremely high impedance which lends itself to the buildup of electrostatic charge, even a very low energy source (such as a static charge) is capable of developing voltages in the order of 80 volts, the typical breakdown voltage of an MOS gate oxide. In contrast with other semiconductor devices in which the breakdown can be tested any number of times without damage, the MOS gate oxide can be shorted, and the device destroyed, as the result of only one voltage excursion to the breakdown limit.

### Protection Networks

Figs. 1 through 4 show the various protection networks incorporated in all COS/MOS product.

### Standard Protection Networks

Fig. 1 shows the standard protection network incorporated in all A-series and some B-series devices. Input-diode  $D_2$  is a

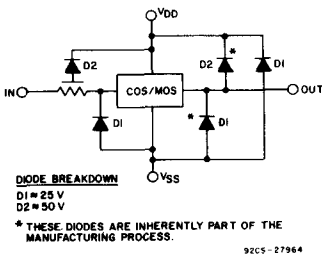

Fig. 1 - Standard protection network.

distributed resistor-diode network that appears as two diodes to  $V_{DD}$ .

### Improved Protection Network

Fig. 2 shows the improved protection network incorporated on all new B-series devices as well as on all A-series B-converted types.

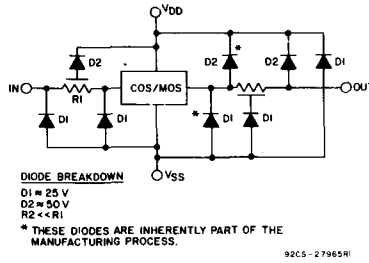

Fig. 2 - Improved protection network.

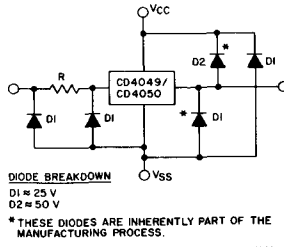

Fig. 3 - Modified protection network.

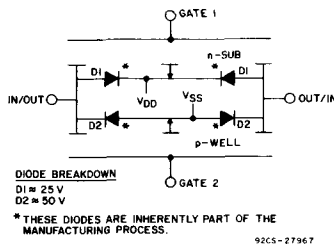

Fig. 4 - Transmission gate with intrinsic diodes that protect against electrostatic discharge.

### Other Protective Networks

Fig. 3 shows the modified protective network for a CD4049/4050 buffer. The input diode to  $V_{DD}$  is not incorporated so that the level-shifting function can occur.

### Equivalent-Body Discharge Network

The protection networks described in this Note are evaluated and characterized by using the equivalent-body discharge network of Fig. 5. As  $C$  is increased, the amount of static energy dumped into the CMOS device increases. As  $R$  is decreased, the energy dissipated outside the device is reduced, thereby increasing the energy dissipated in the unit. A

mercury relay is used to switch the RC source because such relays are fast and free from arcing or bouncing effects. Characterization of the various protection networks is done in 12 different combinations of inputs, outputs, and

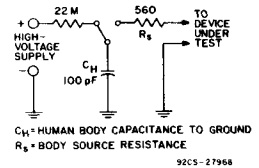

Fig. 5 - Equivalent-body discharge network.

polarities. The combinations include all combinations of any two of the following pins: input,  $V_{DD}$ ,  $V_{SS}$ , and output.

Evaluation of a protective network begins with the charging of a 100-picofarad capacitor through a 22-megohm resistor and a mercury relay to the desired voltage. The capacitor  $C_H$  of Fig. 5 is then discharged through the same mercury relay and a 560-ohm resistor into the pins under test. Results of repetitive tests are used to determine the worst-case capability of the protective networks, Table I.

TABLE I - Worst-Case Capability of Protective Networks

Protective Network	Worst-Case Capability
Standard (incl. CD4049, CD4050)	1 kV to 2 kV
Improved	4 kV
Transmission Gate	<800 V

Additional protection can be obtained by adding external series resistors at device inputs. The value of this resistance should be approximately 10 kilohms for gate inputs and 1 kilohm for transmission gate inputs. In addition, zener diodes at the output pins can clamp the voltage to a safe level. The zener-voltage should not exceed the absolute maximum rating of the part. On-chip protection networks are not used on transmission gates so that their low "on" resistance can be maintained. The 800-volt worst-case capability shown in Table I is provided by the intrinsic diodes shown in Fig. 4.

The value of the input resistor on all protection networks, except that used in

transmission gates, can vary between 100 ohms and 2.5 kilohms because of circuit-design differences. This resistance, in conjunction with the capacitance of the gate and the associated protective diodes, integrates and clamps the device voltages to a safe level. The diagrams of Figs. 6, 7, and 8 demonstrate that the standard protection networks prevent higher than normal voltages from reaching the gate of the MOS device. In addition, the low RC time constant assures that circuit speed remains unchanged in spite of the additional components.

Because of the presence of the integral protection network, the  $V_{DD}$  power supply must not be turned off while a signal from a low-impedance pulse generator is being applied at an input of a COS/MOS circuit. Should the  $V_{DD}$  supply be turned off under such conditions, the  $V_{DD}$  line would be essentially grounded, and a positive voltage from the pulse generator would be impressed across the input diode to  $V_{DD}$ . This voltage could cause permanent damage to the diode or burn out the  $V_{DD}$  metallization. If it is expected that any input excursion

will exceed  $+V_{DD}$  or fall below  $V_{SS}$ , the current through the input diodes should be limited to 10 milliamperes or less to assure safe operation.<sup>1</sup>

Reference

1. For additional operating considerations see "Guide to Better Handling and Operation of CMOS Integrated Circuits," J. Flood, H. L. Pujol, RCA Solid State Application Note ICAN-6525.

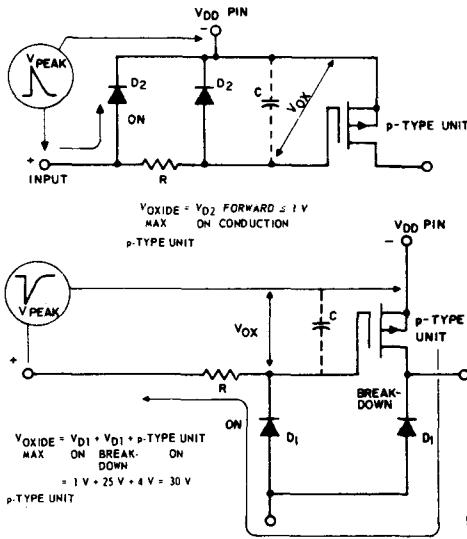

Fig. 6 - Circuits used to provide protection between input pin and  $V_{DD}$  pin.

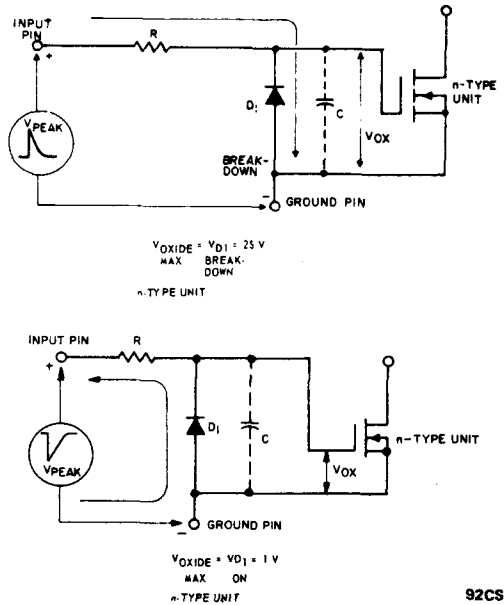

Fig. 7 - Circuits used to provide protection between input pin and ground pin.

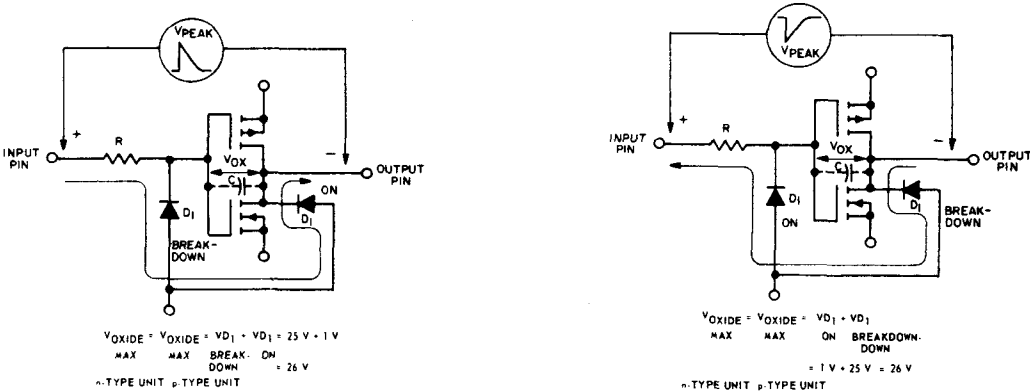

Fig. 8 - Circuits used to provide protection between input pin and output pin.

# ICAN-6576

## Power-Supply Considerations for COS/MOS Devices

by H.L. Pujol

RCA COS/MOS Digital Integrated Circuits operate at extremely low power dissipation levels. They function reliably with high noise immunity over a wide operating-voltage range. The RCA COS/MOS product line includes a standard line designed to operate with voltage supplies from 5 to 15 volts and a low voltage "A" series line designed to operate from 3 to 15 volts. These properties enable system designers to operate RCA COS/MOS devices from unregulated, poorly-filtered supplies, or from a wide variety of single- or multiple-cell battery sources.

This Note describes the salient features of COS/MOS devices which permit operation from such a wide range of power sources and provides the system designer with the necessary information to permit him to design the most economical power source for his COS/MOS system. This Note is applicable to both COS/MOS product lines mentioned above.

### REVIEW OF PERTINENT COS/MOS DEVICE FUNDAMENTALS

#### Enhancement-Mode Device Characteristics

The MOS enhancement transistor is a majority-carrier device (See Fig. 1) in which the current in a conducting channel between two diffused electrodes (denoted as the source and the drain) is controlled (enhanced) by a voltage applied to a third terminal (the gate), which is insulated from the source and drain.

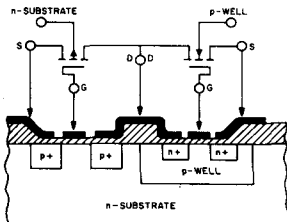

Fig. 1 - Cross-section of COS/MOS transistor.

In an n-type device, the majority carriers are electrons. A positive voltage on the gate is required to enhance the conducting channel. For all gate voltages less than a threshold value ( $V_{th}$ ), the conductivity of the channel is negligible and the device is said to be cut-off. For gate voltages greater than  $V_{th}$ , the channel is "enhanced", and current flow in the channel will occur if a suitable voltage is applied between the source and drain. The resultant device characteristics are shown in Fig. 2a.

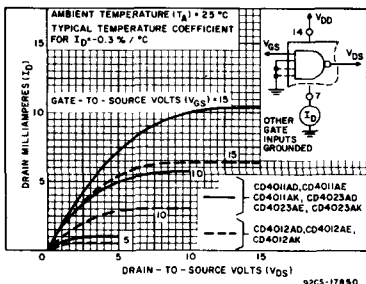

Fig. 2a - Typical n-channel characteristics.

The operation of the p-type device is analogous to that of the n-type, except that the carriers are holes, and the applied voltage required to enhance the channel must be negative rather than positive. (See Fig. 2b).

The gate electrode for a device of either polarity is insulated from the body of the device; therefore, current flows only from source to drain in the channel, never from the gate into the channel.

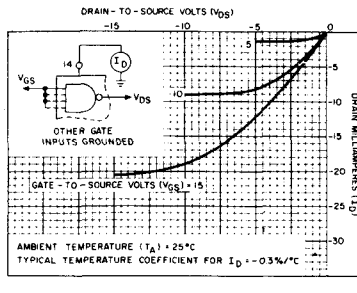

Fig. 2b - Typical p-channel characteristics.

### CHARACTERISTICS OF A BASIC COS/MOS LOGIC INVERTER

#### Quiescent Device Dissipation.

The basic logic inverter (or gate) formed by use of only a p- and an n-type device in series is shown schematically in Fig. 3. When the input lead is grounded or otherwise connected to 0 volts (logical "0"), the n-device is cut-off, and the p-device is biased on. As a result, there is a low-impedance path from the output to  $V_{DD}$ , and an open circuit to ground. The resultant output voltage is essentially  $V_{DD}$ , or a logic "1".

Similarly, when the input voltage is a logic "1", or  $V_{DD}$ , then the n-channel device becomes a low impedance, while the p-channel device becomes an open circuit. The resultant output becomes essentially zero volts (logic "0").

Note that one of the devices is always cut-off at either logic extreme, and that no current flows into the insulating gates. As a result, the inverter quiescent power dissipation is negligible (equal to the product of  $V_{DD}$  times the leakage current).

A cross section of the COS/MOS inverter as it is formed in an integrated circuit on an n-type substrate is illustrated in Fig. 1. The source-drain diffusions and the p-well diffusion form parasitic diodes (in addition to the desired transistors) at the basic inverter nodes, as shown in Fig. 4. These parasitic elements are back-biased (across the power supply) and contribute, in part, to the device leakage current and thus to the quiescent power dissipation.

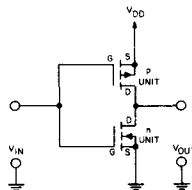

Fig. 3 - Basic COS/MOS inverter (schematic).

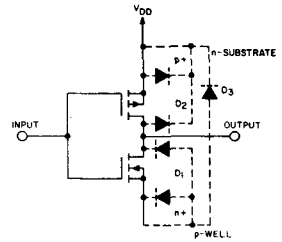

Fig. 4 - Basic inverter showing parasitic diodes.

RCA's product line of COS/MOS devices consists of circuits of varying complexity (i.e., from the dual 4-input logic gate that contain 16 MOS devices, to the more complex 64-bit static shift registers that contain over 1000 devices). These devices occupy different amounts of silicon area and are composed of varying numbers of circuits formed from inverters. Consequently, each device in the family exhibits a particular magnitude of leakage current, depending upon the total effect of device count and parasitic diode area. For example, some logic gates are specified to operate with a typical power dissipation of 5 nW ( $V_{DD} = 10V$ ), but 7-stage counters or registers are specified to operate with a typically power dissipation of 5  $\mu$ W ( $V_{DD} = 10V$ ). Published data includes both typical device quiescent-current levels and maximum levels ( $V_{DD} = 5V$  and  $V_{DD} = 10V$ ). The maximum values are rarely encountered in RCA devices.

#### Device - Switching Characteristics.

The input/output characteristics for the COS/MOS inverter are shown in Fig. 5. As mentioned earlier the signal extremes at the input and output are approximately zero volts (logic "0") and  $V_{DD}$  (logic "1"). The switching point is shown to be typically 45 to 55% of the magnitude of the power-supply voltage (regardless of the magnitude of the power-supply voltage) over the entire range from 3 to 15 volts (or 5 to 15 volts). Note the negligible change in operating point from -55°C to +125°C.

These excellent switching characteristics permit COS/MOS devices to be operated reliably over a wide range of voltages, a property not found in other logic forms.

#### AC Dissipation Characteristics.

During the transition from a logic "0" to a logic "1", both devices are momentarily on. This condition results in a pulse of instantaneous current being drawn from the power supply. The magnitude and duration of this current depends upon the following factors:

- the impedance of the particular devices being used in the inverter circuit
- the magnitude of the power-supply voltage
- the magnitude of the individual device threshold voltages
- the input driver rise and fall times

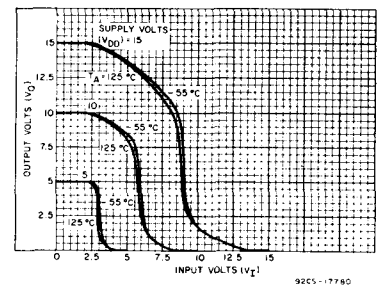

Fig. 5 - Typical COS/MOS transfer characteristics as a function of temperature.



# ICAN-6576

## Power-Supply Regulation Requirements.

The preceding discussion demonstrated that COS/MOS devices exhibit reliable switching properties over a wide range of power-supply voltages. This fact implies that an unregulated supply may be used with the provision that

- (1) maximum voltage limits are not exceeded or
- (2) system speed is no greater than the speed which can be supported by the COS/MOS devices operating at the lowest value of the  $V_{DD}$  expected from the unregulated supply.

To establish the extent of the regulation required, the system designer must first determine the maximum operating frequency required. Usually, the maximum frequency of the system is limited by the slowest responding devices in a logic chain. By reference to the curve of frequency as a function of  $V_{DD}$  and  $C_L$  given in the published data for that device, a minimum  $V_{DD}$  voltage (required for proper operation) can be determined. Any value above this  $V_{DD}$  (minimum) will provide acceptable performance in the system. By selection of a nominal  $V_{DD}$  half way between  $V_{DD}$  (minimum) and the 15-volt maximum rating for COS/MOS devices, the designer can estimate the percentage regulation required for his system to perform adequately.

For example, the published data of the RCA CD4004A 7-stage binary counter shows a curve (shown in Fig. 9) of frequency as a function of operating voltage for that device. For operation of this counter at 5 MHz, with a loading capacitance of 15pF, the minimum operating  $V_{DD}$  permitted for reliable operation is 10 volts, as shown on the curve.

Because the maximum  $V_{DD}$  is 15 volts, a half-way voltage of 12.5 volts should be the nominal value used. In this case, the maximum percentage regulation is 20%. If the designer desires a nominal  $V_{DD}$  closer to  $V_{DD}$  minimum, then better regulation is required, (for example in battery-operated equipment where a standard cell is available).

## Filtering Requirements

Power-supply filtering requirements for COS/MOS systems are minimal. Two factors account for this situation: (1) the low quiescent power dissipations involved, and (2) the fact that the peak value of the ripple does not go below a minimum  $V_{DD}$  (which supports the required switching frequency), so that the COS/MOS logic performs satisfactorily.

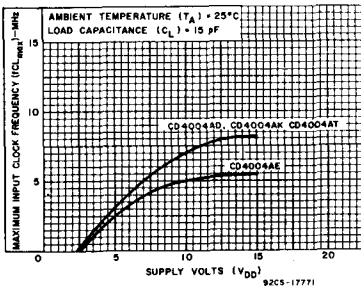

Fig. 9—Maximum frequency as a function of power-supply voltage for the CD4004 and CD4004A types.

This performance has been demonstrated in the laboratory (see Fig. 10). The amount of ripple on the power supply is quite high, yet the device functions properly.

## Typical Supplies

The following circuits indicate some examples of adequate supplies for COS/MOS systems.

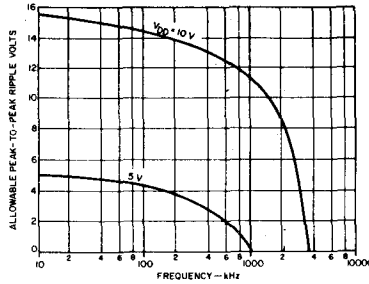

Fig. 10—Peak-to-peak ripple voltage as a function of frequency.

## Battery Standby System

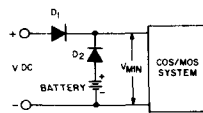

Fig. 11—Battery standby for COS/MOS systems.

This system is advantageous in cases where the dc supply becomes open or short-circuited.

With a low battery voltage the COS/MOS system will continue to function without interruption. In order to drive this system the battery voltage and dc supply voltage should relate as follows:

$$V_{\text{battery}} = V_{\text{min.}} + 0.7V, \quad (0.7V \approx \text{one diode drop})$$

$$V_{\text{max.}} > V_{\text{DC supply}} > V_{\text{min.}} + 1.4V$$

In the event the supply drops below  $V_{\text{min.}}$ , the battery will forward bias diode D2 to form a closed-circuit and the COS/MOS system will continue to function properly through the battery.

## High DC Source

For applications (especially in aircraft equipment) where the supply voltage exceeds the RCA COS/MOS maximum rating of  $V_{DD}$ , the circuit of Fig. 12 can be used to reduce the high supply voltage to the normal COS/MOS voltage range. This configuration uses a Zener diode, a resistor R and a capacitor C.

The low current demand of the COS/MOS system permits an inexpensive but effective Zener diode regulator.

Some of the design considerations are as follows:

## 1. Selection of Zener Diode and Resistor R

The amount of current that must be maintained through the diode ( $I_D$ ) is a function of the difference between the worst-case average current required by the COS/MOS systems and the current required by the Zener diode for regulation based on its particular breakdown characteristics.

The diode current ( $I_D$ ) and the worst-case average system current ( $I_{\text{avg}}$ ) determine the value of the resistor (R) for a particular Zener regulating voltage.

## 2. Selection of Capacitance C

Before the proper capacitance can be selected the following system requirements must be decided upon:

a. Peak charge requirement. This requirement is a function of the peak current and its pulse width. It must be measured for the particular system speed and load capacitance.

b. Permissible  $V_{DD}$  minimum: As mentioned in previous sections, this minimum voltage will determine the maximum operating speed of the COS/MOS system.

The size of the capacitor (C) may then be determined from the following formula:

$$Q = I_{\text{pt}} (\text{charge} = \text{peak current} \times \text{pulse width})$$

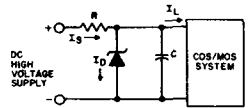

Fig. 12—Circuit for interface of COS/MOS systems to high-voltage supply.

## SUMMARY

This Note shows that RCA COS/MOS devices offer many advantages in the area of simplified power-supply requirements. The wide operating voltage range (3 to 15 volts or 5 to 15 volts) from a single supply, low power dissipation, and high noise immunity permit system designers to use less expensive, unregulated, power supplies. This wide voltage range makes COS/MOS logic circuits ideal for battery-operated equipment because a better selection of cells is feasible. Another advantage is the direct compatibility of COS/MOS devices with bipolar devices which eliminates expensive and power-consuming interface circuits. (See Ref. 1.)

COS/MOS transistors show great potential for use in large arrays because of the low power dissipation and effective use of chip area. The relatively small area consumed by COS/MOS circuits, as well as the elimination of area and power-consuming resistors, results in high circuit-density per unit-silicon-area.

The performance features mentioned in this Note, as well as the reduced costs inherent in IC technology make COS/MOS circuits extremely attractive in many digital systems.

1. "Interfacing COS/MOS WITH OTHER LOGIC Families", ICAN6602 by A. Havassy and M. Kutzin.



## Noise Immunity of COS/MOS B-Series Integrated Circuits

by T. Chesney  
R. Funk

The excellent noise-immunity characteristics of COS/MOS (complementary-symmetry/metal-oxide-semiconductor) digital IC's is a paramount reason for their preferred and successful use in high-noise automotive, process-control, production-monitoring, and similar harsh-noise-prone applications. The introduction of the RCA B-series COS/MOS devices furthers the well-known noise immunity advantages of the COS/MOS technology in two important ways:

1. Improved noise-energy immunity as a result of balanced low-impedance output circuitry in all RCA B-series COS/MOS devices.
2. Standardized (EIA-JEDEC standards) dc noise-immunity and noise-margin ratings covering buffered and unbuffered CMOS logic types.

Included in this Note are brief discussions of logic-system noise and rejection concepts, COS/MOS dc/ac noise-immunity specifications and definitions, and dc/ac noise-immunity performance data for several B-series COS/MOS gates, inverters, and high-current drivers.

### Logic-System Noise Concepts

Successful application of any digital logic IC family requires consideration of the following:

1. Externally or internally generated noise — both radiated and conducted.
2. The inherent noise-immunity capability of the logic family selected.
3. System noise-rejection measures.

Without coordination of these three points, a system design may perform unfavorably.

Consider first the various system or environmental noise generating sources. External system noise may include the noise imposed upon a logic system by electric motors, welders, rf transmitters, x-ray machines, high-current solenoids or relays, pulsed lasers, and circuit breakers. All of the preceding emit EMI (electromagnetic interference), and many produce power-line or ground-path noise disturbance. External noise is characterized by randomly occurring high-energy transients that are not easily anticipated. Usually, this noise is coupled electromagnetically or capacitively to signal, supply, and ground lines. Internal logic-system noise is usually generated on logic-signal lines by capacitively coupled crosstalk or by logic-switching current surges on supply lines or ground lines. In ultra-high-speed logic families such as ECL, reflection noise resulting from an impedance mismatch is also an internal noise problem; but because of relatively long output transition times of CMOS devices (more than 10 nanoseconds), reflection noise can be excluded from further consideration.

Since both external and internal noise must be considered, logic systems must be designed to survive in a medium to severe noise environment, a fact that leads to the second consideration, selection of an IC logic family having noise-rejection characteristics appropriate to the application. As is demonstrated below by considerable data, B-series COS/MOS devices have good dc and ac and noise-energy immunity characteristics. No matter how good the noise-rejection capability of a logic IC family, such as COS/MOS, system design measures to reduce noise entry into logic signal lines, power supply lines, and the ground are usually necessary to some extent. The methods most commonly used to minimize noise effects in COS/MOS logic systems are:

1. Power-source line decoupling - Good practice suggests use of a small-value series resistor and

zener diode and a capacitor to ground on each logic card or each 50 to 100 IC's. High-voltage supply transients can usually be rejected by this simple measure. Separate lines should be used for logic circuits and power switching circuits.

2. Ground-Line Noise - In a system in which many high-current switching components, such as motors, relays, and SCR's are involved, logic grounds should be separated from high energy component grounds. The logic grounds should be returned to a common point.
3. AC noise on system signal inputs - 60 Hz is a commonly used frequency reference. Raw ac power lines should be isolated using a transformer or optical coupler. Zener-diode limiters are also effective. 60-Hz signals can be shaped by using COS/MOS Schmitt-trigger circuits.

### NOISE SPECIFICATIONS

COS/MOS noise immunity is characterized by dc specifications, ac noise-immunity performance, and noise-energy immunity performance. Each of these characteristics is defined below and supported by performance data.

#### DC Specifications

Table I shows the industry standardized (JEDEC) noise immunity and noise margin ratings,  $V_{IL}$  and  $V_{IH}$ , for B-series devices. Note that separate specifications have been established for B (buffered) types and UB (unbuffered) types.<sup>1</sup>

Two important noise characteristics can be defined by using the  $V_{IL}$  and  $V_{IH}$  ratings:

1. Noise Immunity - The  $V_{IL}$  and

# ICAN-6587

$V_{IH}$  limits are the device input-signal noise-immunity ratings which, as defined in Table II, are 30, 30, and 27 percent, respectively, of the 5, 10, and 15-volt supply voltages for the B-series types. Percentages are lower for unbuffered gates, as shown in Table II. The  $V_{IL}$  and  $V_{IH}$  ratings define the maximum permissible additive noise voltages at an input terminal when input signals are 50 millivolts off the supply rails.

2. **Noise Margin** - The difference between  $V_{IL}$  and  $V_O$  or  $V_{IH}$  and  $V_O$  is the device noise-margin voltage for the noninverting case. Table II designates the B and UB noise-margin voltages. Noise margin voltage is defined as that noise voltage that can be impressed upon  $V_{IN}$  at any (or all) logic I/O terminals without upsetting the logic or causing any output to exceed the  $V_O$  ratings of Table I.

Of the two COS/MOS dc noise definitions, immunity and margin, RCA prefers the noise-immunity specification as the more practical COS/MOS system definition because CMOS outputs are normally 50 millivolts off the rails.

However, designers familiar with TTL may prefer to use the noise-margin voltage for system analysis.

## AC Noise Immunity

COS/MOS ac noise immunity takes into account both the device switching threshold (dc noise immunity) and the noise-pulse width. The latter is affected primarily by the COS/MOS IC bandwidth, especially output transition times. Fig. 1 shows the usual COS/MOS noise-voltage amplitude,  $V_t$ , as a function of noise-pulse-width characteristic,  $t_p$ .

Because noise pulses are narrow compared with device output transition time, noise-voltage rejection is high. As the pulse

widths approach the IC bandwidth, the curve flattens out at the device switching-threshold voltage. AC noise-voltage

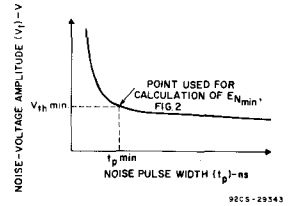

Fig. 1 Generic ac noise-immunity curve.

immunity curves, such as those in Fig. 1, are applicable to:

- Positive noise pulses on signal lines in the 0 state.
- Negative noise pulses on signal lines in the 1 state.
- Positive noise pulses on the ground terminal.
- Negative noise pulses on the positive supply terminal.

Curves of this type indicate the frequency (as defined by noise-pulse characteristics) at which the user has satisfactory dc noise performance. The curves are especially useful in calculating typical noise-energy performance, a parameter that takes into account the circuit impedance.

## Noise-Energy Immunity

Noise-energy immunity takes into account the pulse width and the circuit impedance at the point where the noise is introduced. Noise-energy immunity,  $E_N$ , in nanojoules, is calculated as follows:

$$E_N = \frac{V_{th}^2}{R_O} t_p$$

where  $E_N$  is noise-energy immunity in nanojoules,  $V_{th}$  is the device switching-voltage threshold for a given noise-pulse width,  $t_p$  is the noise-voltage pulse width in nanoseconds, and  $R_O$  is the impedance to ground in ohms at the point of noise entry.  $R_O$  is usually the output resistance of the COS/MOS device.

By using values of  $V$  and  $t_p$  obtained from the curve of Fig. 1, the noise-energy immunity curve of Fig. 2 is generated for a

Table I - B-Series DC Noise Immunity and Noise Margin ( $T_A = 25^\circ C$ )

Characteristics	Test Conditions		Input Voltage (V)	
	$V_O$ (V)	$V_{DD}$ (V)		
Input Low Voltage $V_{IL}$ max.	B types	0.5/4.5	5	1.5
		1/9	10	3
		1.5/13.5	15	4
	UB types	0.5/4.5	5	1
		1/9	10	2
		1.5/13.5	15	2.5
Input High Voltage $V_{IH}$ min.	B types	0.5/4.5	5	3.5
		1/9	10	7
		1.5/13.5	15	11
	UB types	0.5/4.5	5	4
		1/9	10	8
		1.5/13.5	15	12.5

Table II - B-Series Noise Immunity and Noise Margin

$V_{DD}$	Noise Immunity (%)		Noise-Margin Voltage (V)	
	B-Series	UB-Series	B-Series	UB-Series
5	30	20	1	0.5
10	30	20	2	1
15	27	17	2.5	1

given value of  $R_O$ . A comparison of Figs. 1 and 2 shows that the minimum values of

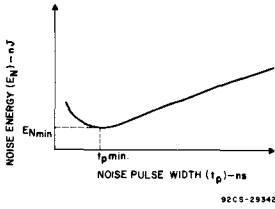

Fig. 2 Generic noise-energy-immunity curve.

noise-energy immunity occur at an input-noise pulse width for which the noise-voltage amplitude of Fig. 1 begins to approach the dc noise-immunity or threshold voltage of a device. The minimum noise-energy immunity is the basis for the calculations and comparisons involving most IC families.

NOISE-IMMUNITY TEST DATA

DC Noise-Immunity Test Data

CMOS dc noise-immunity performance is obtained by plotting the voltage-transfer characteristic of a CMOS gate, inverter, or buffer. Figs. 3 and 4 show the voltage-transfer characteristics of the CD4001B, a

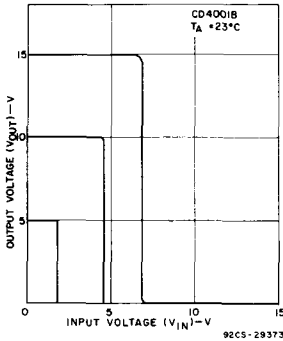

Fig. 3 CD4001B voltage transfer characteristic.

buffered, quad 2-input NOR gate, and the CD4001UB, an unbuffered version of the same gate. Comparison of Figs. 3 and 4 and Table I indicates that the values of  $V_{IL}$  and  $V_{IH}$  for these devices are well

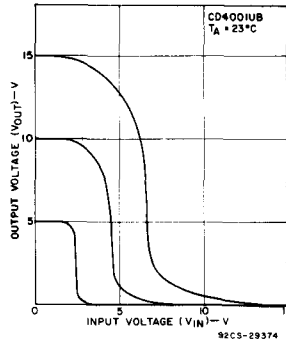

Fig. 4 CD4001UB voltage transfer characteristic.

within the standard JEDEC specifications. The  $V_{IL}$  and  $V_{IH}$  values for any typical COS/MOS device indicate a typical dc noise immunity close to 50 percent of the supply voltage, a paramount advantage of CMOS logic devices over TTL, ECL, PMOS, and NMOS logic devices.

AC Noise-Immunity Test Data

Fig. 5 shows the test circuit used in the evaluation of the ac noise immunity of B-series COS/MOS devices. The criterion used is the triggering of a typical CD4013B flip-flop at the clock input. The

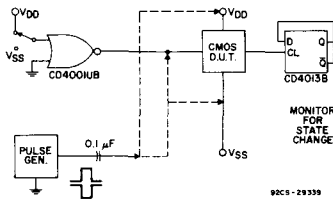

Fig. 5 Test circuit used in the evaluation of B-series COS/MOS devices.

circuit of Fig. 5 accounts for typical CMOS loading factors and generally reflects the ac noise performance of typical B-series devices. The device types used in the evaluation include the following:

- CD4001UB unbuffered quad 2-input NOR gate,
- CD4001B buffered quad 2-input 2-input NOR gate,

- CD4011UB unbuffered quad 2-input NAND gate,
- CD4069UB hex inverter,
- CD4049UB hex inverting buffer.

The above list includes the most commonly used COS/MOS gates, inverters, and buffered devices. The ac noise-immunity characteristics of the buffered NOR gate (CD4001B) reflect the noise-immunity performance of buffered CMOS products of all descriptions.

SIGNAL-LINE OR EXTERNAL NOISE IMMUNITY

The following analysis was used to determine the immunity of a COS/MOS gate to noise on the input line at both the 0 (low-level) and 1 (high-level) logic states.

0-State Analysis

The signal-line noise immunity of COS/MOS gates and inverters was evaluated by means of the test circuit shown in Fig. 6. The COS/MOS units

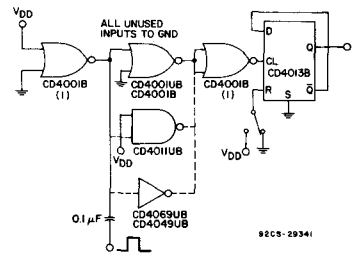
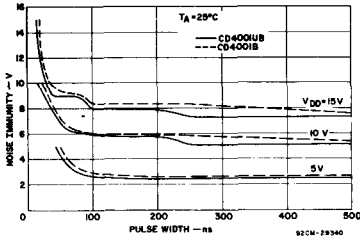

Fig. 6 Test circuit used to evaluate signal-line noise immunity of COS/MOS gates and inverters.

tested were the CD4001UB, CD4001B, CD4011UB, CD4049UB, and CD4069UB. Fig. 7 shows the results obtained. The test circuit is designed to measure the voltage required at the input of the unit under test to trigger a CD4013 flip-flop.

During test, a positive-going noise pulse is introduced into the signal line of the unit under test. At some voltage level, depending on the width of the pulse and the gate thresholds, this pulse causes the flip-flop to be clocked via the CD4001B gate. This voltage level defines the permissible input range for a logical 0.

# ICAN-6587



(a) CD4001B, CD4001UB

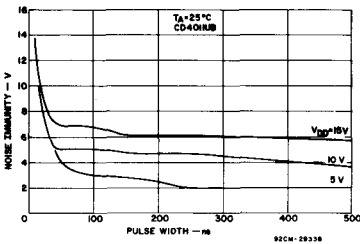

(b) CD4011UB

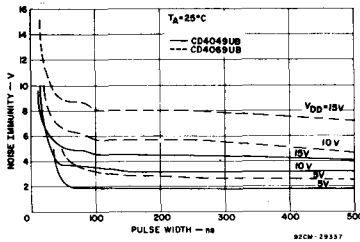

(c) CD4049UB, CD4069UB

$$T_A = 25^\circ$$

Fig. 7 Results of 0-state signal-line noise-immunity tests.

A dc analysis of the transfer characteristics of the components included in the test setup can also be used to determine the noise level required to clock the flip flop. Fig. 8(a) shows that a signal of 4.15 volts is required at the input to the CD4001B gate to produce an output of 4.5 volts at a supply voltage,  $V_{DD}$ , of 10 volts. Fig. 8(b) shows that an input of 5.25 volts is required to trigger the CD4013 flip-flop at a supply voltage,  $V_{DD}$ , of 10 volts. All measured values shown in Fig. 8 were obtained from measurements on gates that have typical threshold-switching characteristics.

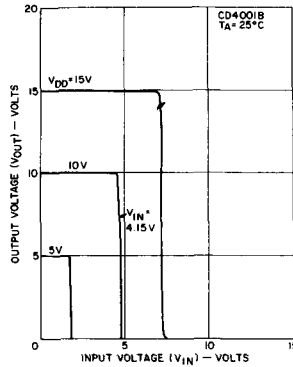

(a) CD4001B

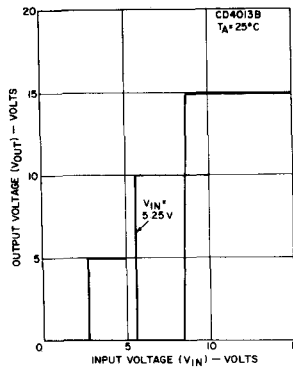

(b) CD4013B

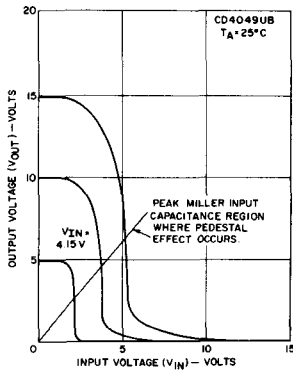

(c) CD4049UB  $T_A = 25^\circ\text{C}$ .

Fig. 8 Transfer characteristics of components used in the circuit of Fig. 6.

Careful analysis of the ac noise curves of Fig. 7(c) (for the CD4049UB) for 0-state signal-line noise shows a voltage-pedestal effect occurring at noise pulse widths associated with the noise-threshold region of the units under test. A comparison of the voltage-transfer curves of Fig. 8(c) with the dynamic input capacitance curves for the CD4049UB, Fig. 9, reveals that this pedestal effect occurs in the same region as the peak Miller input capacitance, where the inverter is in its maximum linear-gain region. Most 0- and 1-state noise-voltage characteristics curves in this Note exhibit this pedestal effect to some degree.

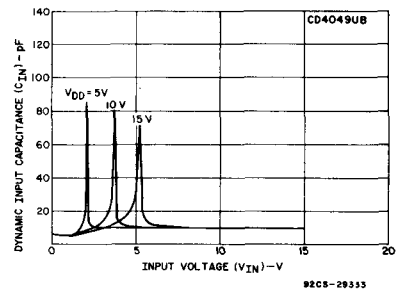

Fig. 9 Dynamic input capacitance curves for the CD4049UB.  $T_A = 25^\circ\text{C}$ .

## 1-STATE ANALYSIS

Fig. 10 shows the test arrangement used and Fig. 11 the results obtained from noise-immunity measurements on the COS/MOS logic gates and inverters identified above when the input is high and a negative-going pulse is superimposed on the signal line.

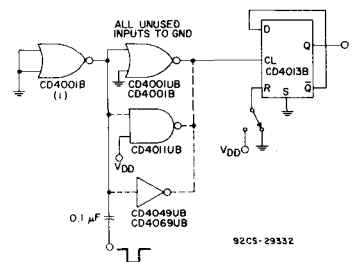
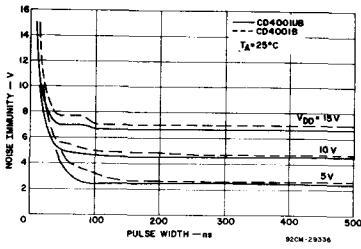
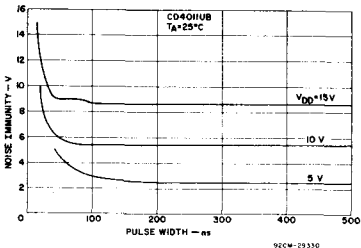

Fig. 10 Test circuit used to measure noise immunity of COS/MOS logic gates and inverters when the input is high and a negative-going pulse is superimposed on the signal line.



(a) CD4001B, CD4001UB



(b) CD4011UB

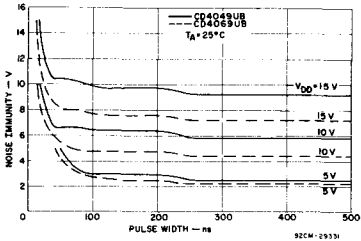

(c) CD4049UB, CD4069UB

$T_A = 25^\circ\text{C}$ .

Fig. 11 Results of 1-state signal-line noise-immunity test.

**POWER-SUPPLY NOISE IMMUNITY**

The test configuration shown in Fig. 12 measures the ability of test units to withstand a negative-going noise pulse superimposed on the supply line without a change in state; Fig. 13 shows results of tests. A pulse of sufficient amplitude causes the output of the gate to decrease so that, at some point, the CD4013B flip-flop is triggered from the rising voltage at the output of the driving inverter stage.

It should be noted that two power supplies are used in the arrangement of Fig. 12. An equivalent resistor or inductor

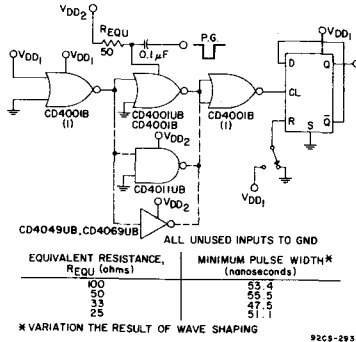
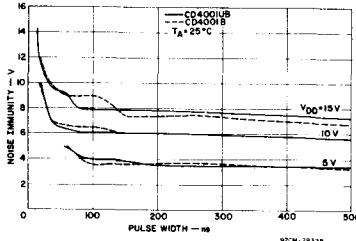
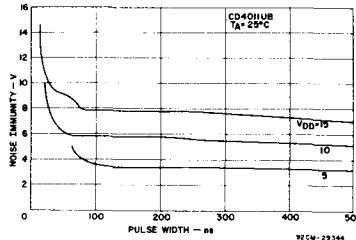

Fig. 12 Test circuit used to measure the ability of test units to withstand a negative-going noise pulse on the supply line without a change in state.



(a) CD4001B, CD4001UB



(b) CD4011UB

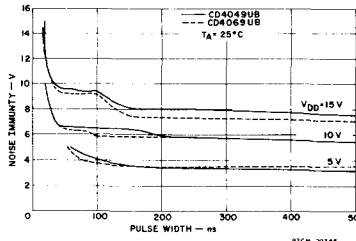

(c) CD4049UB, CD4069UB

$T_A = 25^\circ\text{C}$ .

Fig. 13 Power-line noise immunity.

for simulating contact resistance and lead length is used in the  $V_{DD}$  line of the unit under test. Without this resistance the test unit will not react to the noise pulse.

**GROUND-NOISE IMMUNITY**

Noise on the power line may be effectively reduced or eliminated by the use of decoupling capacitors; however, ground-line noise cannot be reduced so easily and, therefore, is more objectionable. Fig. 14 shows the test circuit used to measure the ground-line noise immunity of COS/MOS gates and inverters; Fig. 15 shows curves of the results obtained. Again, the units under test would not react to the noise unless a 25-ohm resistor or small inductor simulating lead length or contact resistance were placed to ground.

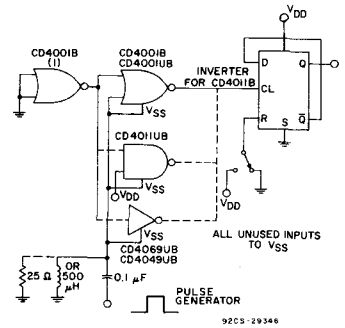

Fig. 14 Circuit used to measure ground-line noise immunity.

**CROSSTALK NOISE IMMUNITY**

A test circuit used to evaluate crosstalk is shown in Fig. 16. A noise pulse from a pulse generator is coupled to the signal line of the gate or inverter through a capacitor. The noise voltage necessary to trigger the flip-flop is then measured for different values of capacitance under high and low input conditions. Fig. 17 shows the effect of capacitance on the inputs of the units under test.

The circuit shown in Fig. 18 more closely approximates crosstalk caused by adjacent signal lines. The response of the test circuit to a noise pulse may be explained by analysis of the response of a high-pass RC circuit to a ramp input of  $V_i = \alpha t$ , where  $\alpha$  is the coefficient of

# ICAN-6587

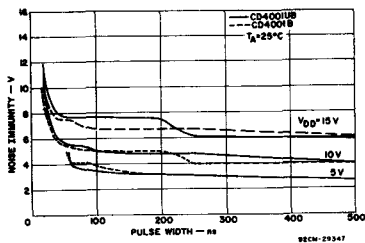

(a) CD4001B, CD4001UB

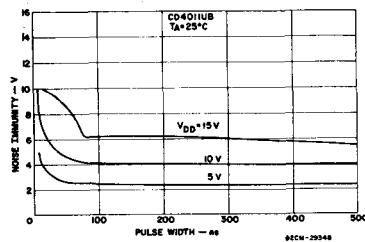

(b) CD4011UB

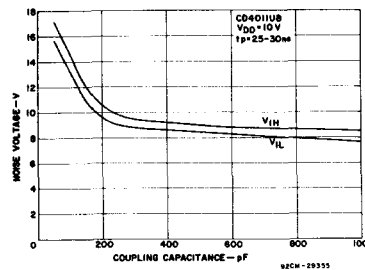

(c) CD4049UB, CD4069UB

Fig. 15 Ground-line noise-immunity measurements.

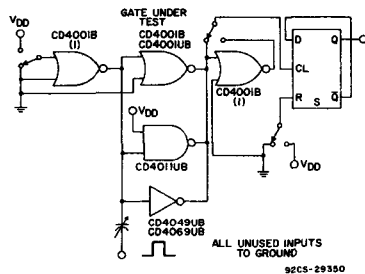

92CM-29350

Fig. 16 Circuit for measuring noise voltage as a function of coupling capacitance.

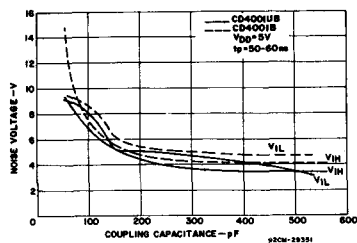

92CM-29351

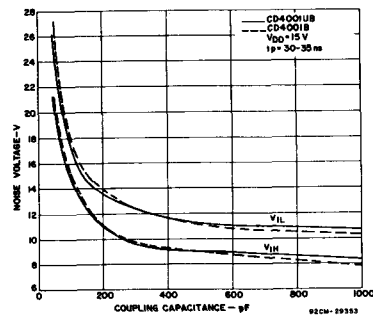

92CM-29353

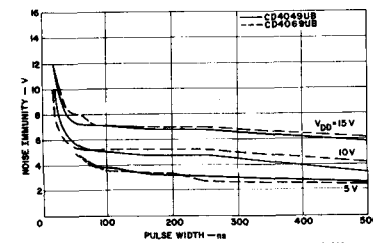

92CM-29349

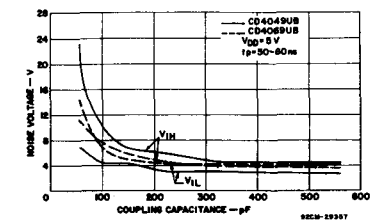

92CM-29357

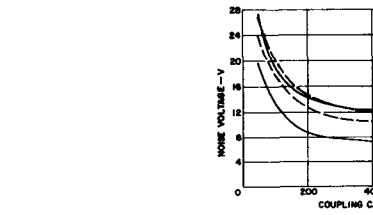

92CM-29360

Fig. 17 Effect of coupling capacitance on the inputs of the units under test ( $T_A = 25^\circ\text{C}$ ).

coupling and  $t$  is rise time, 10 to 90 percent. The output voltage  $V_O$  may be expressed by the following equation:

$$V_O = \alpha RC (1 - e^{-t/RC}) \quad (1)$$

The equivalent circuit for the part of the test configuration used in this analysis is shown in Fig. 19. On the basis of this equivalent circuit, Eq. (1) may be rewritten as follows:

$$V_O \text{ max} \cong \alpha (Z_O \parallel Z_{IN} C [(1 - e^{-t/2Z_O \parallel Z_{IN}}) C] \quad (2)$$

If  $V_i$  is assumed to be  $\alpha t$  during the period in which the output voltage switches from 10 to 90 percent of its total value, this change in output voltage can be expressed as follows:

$$\Delta V_O \text{ max} \approx \frac{V_i (Z_O \parallel Z_{in}) C}{t} \cdot [1 - e^{-t/2 Z_O \parallel Z_{in}}] C \quad (3)$$

The results of this analysis may be applied to the various crosstalk waveforms obtained.

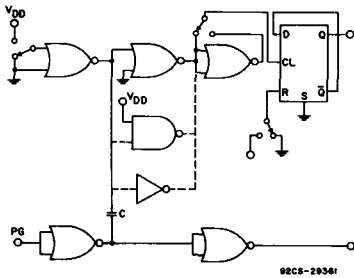

Fig. 18 Circuit closely approximating conditions for crosstalk on adjacent signal lines.

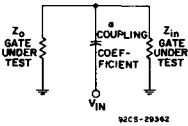

Fig. 19 Equivalent circuit used in crosstalk analysis of test configuration shown in Fig. 18.

Crosstalk measurements that simulate actual operation are made by use of the test circuits shown in Figs. 20 and 21. The

circuit of Fig. 20 simulates a round-cable system and Fig. 21 a ribbon-cable system.

In Fig. 20, a sense line is placed tightly within five surrounding wires (No. 22 gauge) to form a 6-foot-long cable with a capacitance of 18 picofarads per foot (determined by measurement).

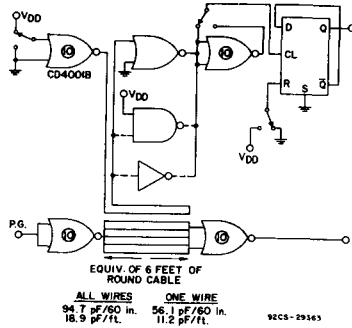

Fig. 20 Circuit simulating a round-cable system.

In Fig. 21, a sense line is placed between two adjacent driving lines (No. 22 gauge) of a 6-foot-long ribbon cable with a capacitance of 16 picofarads per foot (determined by measurement).

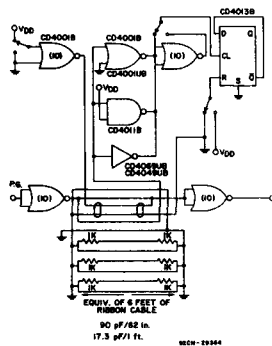

Fig. 21 Circuit simulating a ribbon-cable system.

The results of crosstalk are shown in the photographs of Figs. 22 and 23 for round cable and ribbon cable, respectively. The crosstalk was insufficient to trigger the CD4013B under all conditions of the circuits of Figs. 20 and 21.

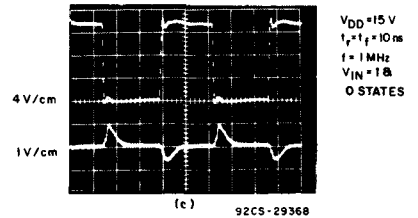
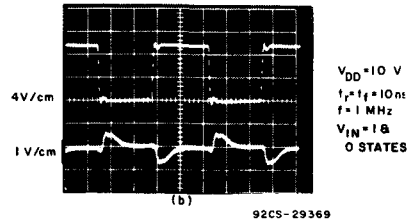
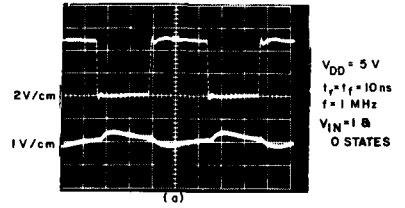

Fig. 22 Crosstalk in the round-cable system.

NOISE-ENERGY-IMMUNITY PERFORMANCE DATA

Table III shows computed values of noise-energy immunity for the gate, inverter, and buffer types identified above. Noise pulse width,  $t_p$ , and noise threshold voltage,  $V_T$ , data were obtained directly from the 1 and 0 signal-input ac noise-immunity test curves presented earlier in this Note, Figs. 7 and 11. Values of  $R_O$  are typical output impedances for the CD4001B driving gate used in obtaining the curves. Fig. 24 is a plot of high- and low-input state noise-energy immunity for the CD4001B gate as a function of input pulse width. These curves show that noise-energy immunity is high for noise bandwidths that exceed the speed capability of the device, and a minimum of approximately 1.3 nanojoules where the noise-pulse width (50 to 100 nanoseconds) approximates the device output transition time. Noise-threshold energy increases steadily with greater pulse widths.

Table III - Typical Values of Noise-Energy Immunity.

TYPE	SUPPLY VOLTAGE V <sub>DD</sub> (V)	NOISE PULSE WIDTH		NOISE THRESHOLD VOLTAGE V <sub>t</sub> (V)		TYPICAL SIGNAL LINE IMPEDANCE R <sub>O</sub> (ohms)		TYPICAL NOISE-ENERGY IMMUNITY*	
		t <sub>p</sub> (ns)		LOW	HIGH	R <sub>OL</sub>	R <sub>OH</sub>	LOGIC STATE	
		LOW	HIGH					ENL (nJ)	ENH (nJ)
CD4001UB	5	100	100	2.75	2.65	700	700	1.08	1.00
	10	60	40	6.3	5.1	270	270	8.82	3.85
	15	40	40	9.0	7.0	190	190	17.05	10.32
CD4001B	5	160	150	2.58	2.85	700	700	1.52	1.74
	10	80	40	6.2	5.6	270	270	11.40	4.65
	15	40	40	9.6	7.8	190	190	19.40	12.81
CD4011UB	5	100	140	3.0	2.67	700	700	1.29	1.43
	10	40	80	5.0	5.45	270	270	3.70	8.80
	15	60	40	6.9	9.1	190	190	15.03	17.43
CD4049UB	5	60	120	2.0	2.9	700	700	0.343	1.44
	10	40	40	3.7	6.7	270	270	2.03	6.65
	15	60	40	4.9	10.4	190	190	7.58	22.77
CD4049UB	5	150	150	2.75	2.60	700	700	1.62	1.45
	10	60	60	6.4	5.2	270	270	9.10	6.01
	15	40	60	8.7	8.0	190	190	15.94	20.21

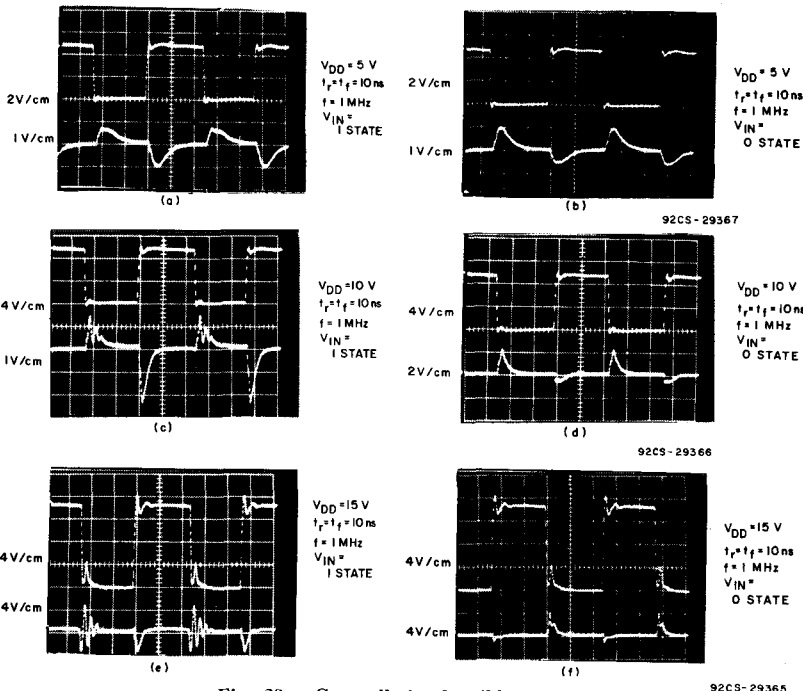

Fig. 23 Crosstalk in the ribbon-cable system.

CONCLUSIONS

The noise-immunity test data demonstrates the high noise immunity of COS/MOS digital integrated circuits. Typical ac noise-voltage immunity for an unbuffered gate is 2 volts for a 5-volt supply, 5 volts for a 10-volt supply, and 7 volts for a 15-volt supply. As expected, the

low-level ac noise-immunity for the CD4049UB buffer is slightly lower because of the lower effective input threshold of the large NMOS transistor used.

Of paramount interest is the good noise-energy performance of approximately 1.3 nanojoules for B-series gates, which is

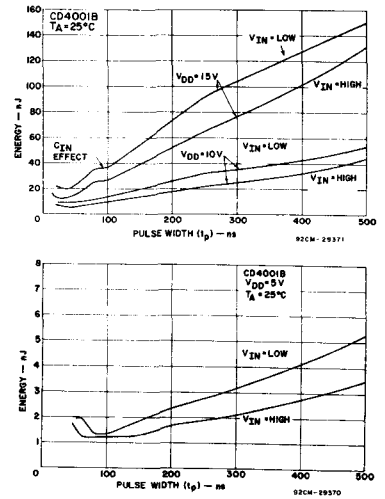

Fig. 24 High- and low-input state noise-energy immunity for the CD4001B gate as a function of input pulse width. T<sub>A</sub> = 25°C.

comparable to the performance of bipolar TTL gates at 5 volts despite their much higher output drive current. At operation above 5 volts, the noise-energy immunity of COS/MOS devices ranges up to 20 nanojoules at 15 volts, far exceeding the noise-energy immunity of TTL. This improved noise immunity makes CMOS logic devices far more economical to use in high-noise automotive and industrial control environments than TTL devices. This noise-rejection capability exceeds even that of bipolar high-threshold logic, which has only approximately 5 nanojoules of noise-energy rejection in the high logic-input state.

The good inherent noise immunity provided by COS/MOS devices leads to design economy, and complements the accompanying benefits of COS/MOS: low-cost, medium- to high-speed operation, wide operating voltage range, good temperature stability, wide selection of SSI, MSI, and LSI device types, etc.

References

1. "Understanding Buffered and Unbuffered CMOS Characteristics," R.E. Funk, RCA Solid State Application Note ICAN-6558.
2. "Noise Immunity of COS/MOS Integrated Circuits," S.S. Eaton, RCA Solid State Application Note ICAN-6176. Discusses noise immunity of A-series devices.
3. "Designing Logic Circuits for High Noise Immunity," Verell Boalen, IEEE Spectrum, Jan. 1973.
4. JEDEC Standard for B-series COS/MOS devices.



# Interfacing Analog and Digital Displays with CMOS Integrated Circuits

by J. E. Gillberg

Many forms of displays are available for interfacing digital and analog information from electronic circuits with the individual end user. The display choice generally takes into consideration not only technical feasibility but also visual impact and often aesthetic appeal. Until recently, the analog display, primarily motors (both synchronous and stepper) with gears, hands, or drums, has been the most widely used. At present, however, new developments are making the digital display the more dominant method.

This Note describes some of the COS/MOS integrated circuits most suitable for interfacing the electronic circuit and the display. In the case of digital displays, it describes basic display operation to help simplify the equipment designer's task in selecting both the most appropriate display and the most suitable interfacing device.

## Analog Display Drivers

Analog displays are usually driven from either a synchronous motor or a stepper motor. The synchronous motor receives an incoming signal at a frequency of approximately 60 Hz and continuously

rotates at that frequency. The stepper motor receives an incoming signal at about 0.5 to 2 Hz and rotates only during the active pulse interval. The stepper motor gives the effect of a non-continuous movement of the motor or wheel.

One of the major users of digital circuits with analog displays is the timekeeping market. This market has continued to use analog displays because of the many basic advantages of the familiar clock or watch face with moving hands. These advantages include low cost, high reliability, simplified electronics, familiarity of display mode, and low current drain.

A number of IC's are available for interfacing the electronic clock circuitry and the analog display. An excellent example is the CD4045, a COS/MOS 21-Stage Counter. As shown in Fig. 1, this device can be used in timing applications not only to generate the crystal oscillator output, but also, because of its output current capability, to directly drive a stepper motor. Fig. 2 gives curves illustrating the current capabilities of the CD4045.

One method of reducing the current drain of a stepper motor is to terminate the

incoming pulse at the precise moment the armature achieves enough momentum to rotate to the next position without any additional current. The Low-Voltage COS/MOS Analog Timepiece Circuit CD22010E has the capability of detecting, as shown in Fig. 3, when no additional current is required by the motor. It operates as follows. At the beginning of the output pulse because the load is inductive no current will immediately flow ( $V = L di/dt$ ) and the voltage at the output will be at ground, as shown in Fig. 4 at  $t_0$ . After time, the current will begin to flow into the pull-down n-channel transistor of the CD22010E. This current

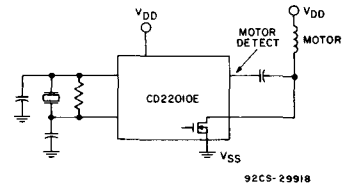

Fig. 3 - CD22010E, a low-voltage COS/MOS analog timepiece circuit, used to detect status of stepper motor current.

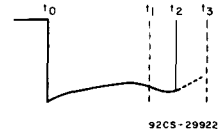

Fig. 4 - Nominal output pulse of stepper motor.

flow raises the output voltage until the motor begins to rotate and cause a back electro-motive force thereby reducing the voltage at the output. Once the motor has achieved enough momentum to move on its own inertia, however, any added current again raises the output voltage. The time interval from  $t_0$  to  $t_2$  in Fig. 4 is the nominal output pulse. Time  $t_1$  indicates the end of an internal activation period after which any rising edge on the output will trigger internal circuitry to terminate the pulse width, thus saving battery current.

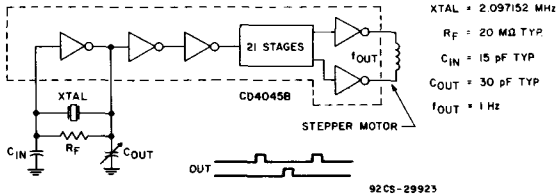

Fig. 1 - CD4045, COS/MOS 21-stage counter, used to generate crystal oscillator output and to drive stepper motor.

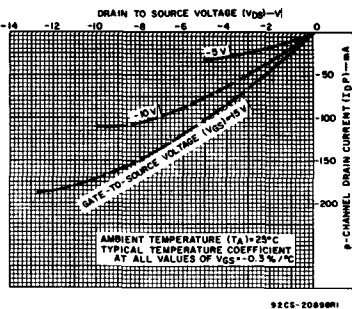
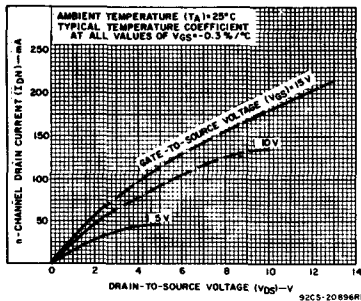

Fig. 2 - Typical output n-channel and p-channel drain characteristics of the CD4045.

The battery-operated wall clock is one of the major areas for analog displays primarily because of the low-voltage (1.5 to 3.0 V typical) and low-current (60 A typical) operation. A number of display interface circuits are available for this application. The most suitable depends upon the type motor and the voltage being used. Several of these circuits are illustrated in Fig. 5. In Fig. 5(c), the capacitor  $C_D$  increases the maximum pulse or spike current supplied to the

## ICAN-6595

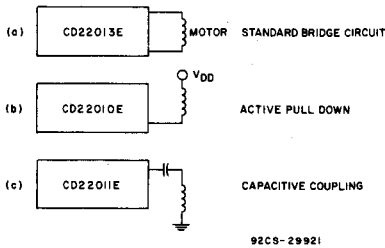

Fig. 5 - Typical motor interface circuits for analog watch or wall clock circuits.

motor. The value of this added capacitor is typically between 1 and 10 microfarads and is dependent upon the frequency of operation.

Many integrated circuits are available from RCA that can be used to interface an analog high-current-drive display. Table I lists several of these devices. For technical data on these devices see the RCA INTEGRATED CIRCUITS DATABOOK SSD-250 or the technical data sheet for the specific device.

### Digital Display Systems

With the development of MSI and LSI, digital displays emerged as an important method of information transfer and many new display systems appeared. The most popular or promising types of digital displays are listed in Table II along with a brief summary of their major advantages and disadvantages. In the following material each display system is discussed with the emphasis on adaptability to interfacing electronic circuitry.

Table I - Analog-Display Driver and Counter COS/MOS Integrated Circuits

Type	Family Dev. No.	Package	Volts	Freq.	Description
<b>Clocks</b>					
CD22010E	TA6656	8-DIP	1.5	32 kHz	Portescap stepping-motor drive, with pulse-width control (1 Hz)
CD22011E	TA10294	8-DIP	1.5	4 MHz	SOS stepping-motor drive (2 Hz push-pull)
<b>Auto Clocks</b>					
CD22012E	TA6489	14-DIP	12	4 MHz	Quartz analog auto clock (0.5 Hz push-pull)
CD22013E	TA10176	8-DIP	12	3 MHz	Quartz analog auto clock (64 Hz push-pull)
CD22014E	TA6817	8-DIP	12	4 MHz	Quartz analog clock (60 Hz)
CD22015E	TA10177	8-DIP	12	2 MHz	Quartz analog auto clock (30 Hz push-pull)
<b>Industrial Timers</b>					
CD22017E		16-DIP	10		Universal industrial timer

Table II - Digital Display Technologies

Type	Advantage	Disadvantage
Liquid Crystal	Low power, low voltage	AC signal - difficult to multiplex
Light-emitting diode	Low cost, simple interface	High current, visibility
Gas discharge	Easily read	High voltage
Fluorescent	Low segment current, low cost	High filament current/fragile
Incandescent	Brightness, low cost	High current

## Liquid Crystal Displays

The most important advantage of the liquid crystal display is its very low power consumption, typically 50 microwatts per character. The reason for this low power consumption is that the liquid crystal display does not generate or emit light, but controls reflected or transmitted light generated elsewhere.

The liquid crystal display device consists of a layer of liquid crystal material sealed between two conductive-coated glass plates. The liquid crystals are fluids having molecule alignment characteristics very similar to those of solid crystals. The alignment of the molecules can be changed by the application of an ac signal. This change in alignment can produce image

patterns determined by the physical construction of the device. Electrical contact is made to the liquid crystal by means of a transparent conductor. Because the image pattern depends upon molecular alignment, the direction which light strikes the liquid crystal is very critical. As a result, light polarizers are attached to the front and back to control whether the display is dark on a light background or light on a dark background. Fig. 6 shows the sandwich-type construction and the arrows illustrate the molecular polarization of a liquid crystal material resulting from an ac field.

There are two basic types of LCD's: dynamic scattering devices and field-effect devices. When an ac field is applied to a dynamic scattering liquid crystal, the

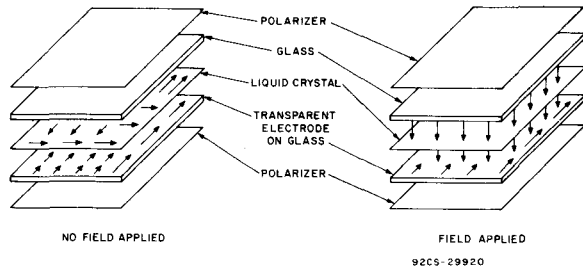

Fig. 6 - Basic operation of field-effect type liquid crystal device showing molecule alignment and major elements.

molecules which are normally aligned, and hence transparent, are rearranged to scatter any available light, and the display becomes opaque. The field-effect type displays a visual change when the molecule alignment is rotated from one plane to another, as illustrated in Fig. 6. The field-effect liquid-crystal device has become the more popular display.

Two kinds of liquid-crystal devices are available in either the dynamic-scattering or field-effect category: reflective and transmissive. The only difference is that for the former, reflective material is added to the back of the display to reflect the light entering the front. This type is well-suited for applications where substantial ambient light is available. In applications, where the ambient light is small, the transmissive display could be used with some form of back lighting.

Liquid-crystal devices require an ac drive signal having no dc component. A dc component can cause an electrolysis plating action which can eventually damage the display. For field-effect displays, this drive signal may be from 2 to 10 volts at 60 to 10,000 hertz; for dynamic-

scattering devices, the signal may be from 7 to 30 volts at 20 to 400 hertz.

When a liquid-crystal segment is activated by a drive signal, the phase relation between it and the transparent electrode applied to the glass backplane is 180° and a visual display results. When no drive signal is applied to the segment, the backplane and segment are in phase and the visual display is off.

The usual method of activating a segment is to apply a square wave which is out of phase with the square wave applied to the common backplane. As shown in Fig. 7, when the segment square wave is in phase with the back-plane square wave, the segment is not activated. By the use of a square wave for both the common (backplane) and the selected segment drive signal, the effective dc voltage across the display is always zero regardless of whether the display is activated or not.

Liquid crystals offer the important advantages of requiring very little power and low voltage. Their disadvantages are:

1. Because they need an ac signal for operation, multiplexing is difficult.
2. They need good ambient light or back lighting.
3. They have a limited operating temperature range: -20 to 60 or 85°C.
4. Their cost in relation to other displays is high.
5. Their response time is slow: 100 to 300 milliseconds.

RCA offers several display drivers for liquid crystal devices: the CD4054, a 4-segment display driver; the CD4055, a BCD-to-7-segment decoder/driver with "display frequency" output; and the CD4056, a BCD-to-7-segment decoder/driver with strobed-latch function. These devices have level-shifting capability for interfacing low-voltage logic signals to higher-voltage display signals. In addition, a full line of direct drive LCD watch chips is available.

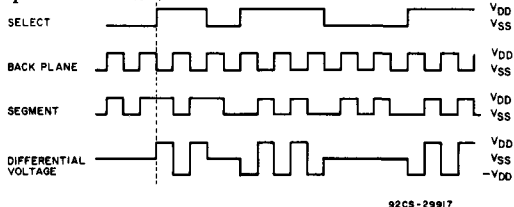

Fig. 7 - Timing diagram of liquid crystal element voltages showing how segments are activated by square waves to avoid damaging effects of a dc component.

Light-Emitting Diodes

The light-emitting diode (LED) has also received wide acceptance as a digital display in the last several years because of its low-voltage operation, long life, ease of multiplexing, high reliability, and fast response time. An LED is a semiconductor diode composed of a p-n junction. In forward-biased operation, because of recombination of holes and electrons, the diodes radiate a colored light in a narrow spectrum. LED displays are normally constructed of either gallium phosphide (GaP) or gallium arsenide phosphide (GaAsP) semiconductor material. Both types of LED displays have approximately equal advantages and disadvantages. The GaAsP type, however, is more prevalent for red displays. The forward drop is approximately 1.6 volts for GaAsP diodes and 2.1 volts for GaP diodes. Two configurations of LED are available: common anode (requiring sink current) and common cathode (requiring source current). Fig. 8 illustrates both types of device.

Any single LED segment is electrically the same as any conventional solid-state diode although the LED does have a slightly higher forward voltage drop. Once the forward voltage reaches approximately 1.6 volts, the current which up to that point has been very small increases rapidly. A typical GaAsP LED needs approximately 5 to 30 milliamperes for a reasonable amount of brightness. If current continues to increase, the LED will reach a light saturation mode at approximately 100 to 150 milliamperes. At this point any increase in current will not increase the amount of light generated. Because the efficiency is greater for higher currents and the electrical and light output rise times are in nanoseconds, LED's are well suited for multiplexed or pulsed output drive. Pulsed output drive can also decrease the total amount of power required to achieve a given brightness by as much as 30 per cent.

As an example, consider the design of a four-digit multiplexed LED display system to interface with a four-digit information storage device. The LED needs an average of 6 milliamperes of current to achieve the desired brightness. Because there are four digits, the multiplexed signal requires a 25 per cent duty cycle. The peak current, therefore, must be 4 x 6 milliamperes to achieve the 6-milliamperes average current. The CD4511 BCD-to-seven-segment latch decoder driver is designed with emitter-follower n-p-n bipolar outputs and is therefore able to supply the needed peak current of 24 milliamperes. The digit driver must be able to sink a peak current of 7 x 24 or 168 milliamperes when all segments are turned on. Many available discrete or integrated bipolar devices can meet this requirement. Fig. 9 illustrates a suitable circuit. This circuit uses a CD4511, a BCD-to-7-segment latch decoder driver; CD4052's, differential four-channel multiplexers; CD4094's, eight-stage shift-and-store bus registers; and CD4011 NAND gates.

The multiplexing digit signal, which can also be used to clock a counter to control the CD4052, can be derived by use of a CD4017 as shown in Fig. 10. The CD4017 is a counter/divider having ten decoded outputs. The number of digits multiplexed can be increased beyond four by taking the digit drive from a higher output on the CD4017. The output should be N + 1 where N equals the number of digits to be multiplexed. The CD4017 must be interfaced to a bipolar driver to be able to sink or source the current needed by each digit (168 milliamperes).

Fig. 11 shows a typical digit driving circuit. The calculation of the value of resistor R<sub>1</sub> can be made as follows:

$$\text{Let } \beta = \text{the gain of the transistor}$$

$$\text{then } \beta I_1 \geq 168 \text{ mA}$$

$$\text{or } I_1 \geq 168/\beta \text{ mA}$$

Once V<sub>DD</sub> is established, a given V<sub>DS</sub> can be taken from Fig. 11b for current I<sub>1</sub>.

$$\text{Therefore, } R_1 = (V_{DS} - 0.7)/I_1 \text{ kilohms}$$

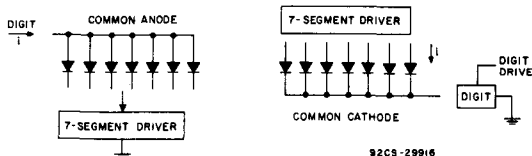

Fig. 8 - Common cathode and common anode light-emitting diode configurations.

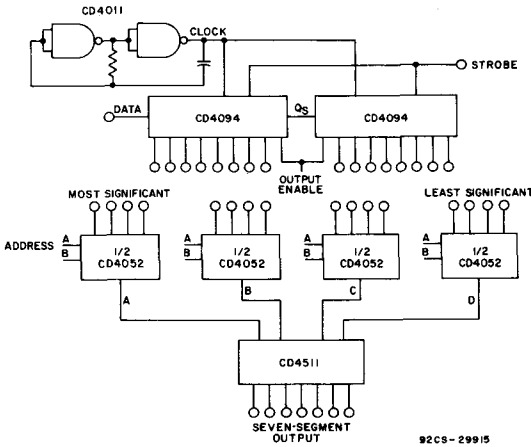
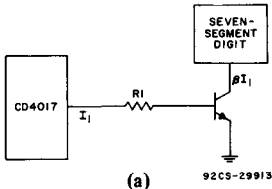
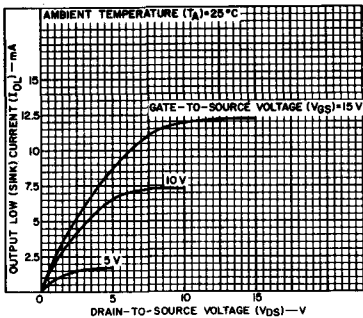

Fig. 9 - Interfacing of four-digit multiplexed LED display system with a four-digit information storage device.



(a) 92CS-29913



(b) 92CS-24319R1

Fig. 11 - Typical digit driving circuit and minimum output n-channel drain characteristic used for calculating value of resistor R1.

Fig. 12 shows the segment and digit drive. Resistor R<sub>2</sub> is necessary to avoid current "hogging" in the LED segments. The value of R<sub>2</sub> is calculated from the curves in Fig. 13 showing output current as a function of output voltage for the CD4511B and from the information supplied with the LED.

Let I<sub>S</sub> = peak current in segment

V<sub>OUT</sub> = voltage out of the CD4511B from Fig. 13 at the V<sub>DD</sub> being used in the system

V<sub>D</sub> = voltage across LED segment for required brightness

V<sub>CE</sub> = voltage across digit driver transistor

Then,

$$R_2 = \frac{V_{DD} - (V_{OUT} + V_D + V_{CE})}{I_S}$$

In this example

$$R_2 = \frac{V_{DD} - (V_{OUT} + V_D + V_{CE})}{24 \text{ mA}}$$

kilohms

If the value chosen for R<sub>2</sub> is too low, uneven segment lighting can occur. Resistor R<sub>2</sub>, therefore, should be as large as possible.

One major drawback to the use of LED displays is that the contrast ratio of the display is very low in bright light. The easiest means of correction is to place an

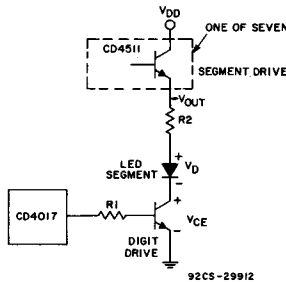

92CS-29912

Fig. 12 - Segment and digit drive circuit for LED.

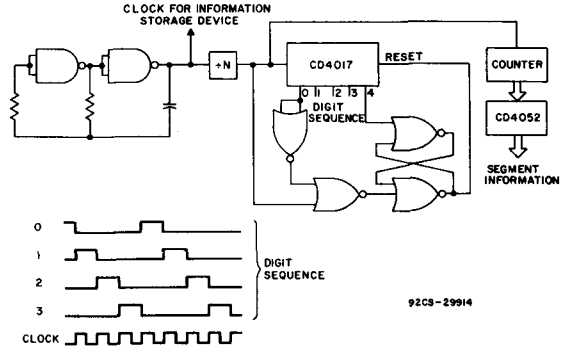

Fig. 10 - Use of CD4017, a counter/divider having ten decoded outputs, to provide the multiplexing digit signal.

optical filter in front of the LED. This filter increases the contrast ratio of the LED display and makes it easier to read in any ambient light.

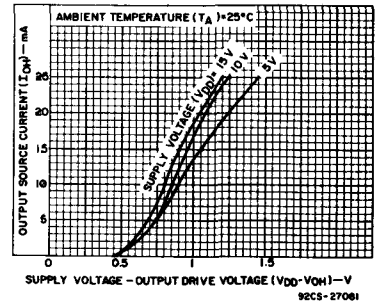

Fig. 13 - Typical voltage drop (V<sub>DD</sub> to output) vs. output source current as a function of supply for the CD4511.

### Gas-Discharge Displays

Gas-discharge or cold-cathode displays are available in both seven-segment and one-of-ten decoded displays. The one-of-ten decoded displays operate by energizing one of a series of stacked cathodes each in the shape of the numeral to be displayed. This stacked arrangement causes some viewing problems because the different numbers appear to move in or out within the display. A CD4028 BCD-to-decimal decoder could be used for the one-of-ten-decoding necessary for this type of device. The seven-segment decoded gas-discharge displays operate in a very similar manner to the seven-segment LED displays mentioned earlier.

One disadvantage of gas-discharge displays is the high potential needed to activate the display. Typically, a voltage between 80 and 200 volts is necessary to cause ionization of the enclosed gas. Once

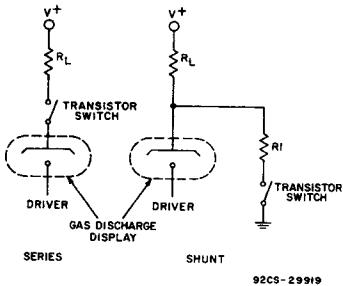

Fig. 14 - Basic series and shunt circuits for multiplexing gas-discharge displays.

ionization takes place, the cathode glows a dull red or orange-like color. In multiplexing these devices, care must be taken to make sure that segments energized for one digit are completely deionized before the next digit is activated.

For multiplexing gas-discharge displays, either the shunt or the series method can be used. See Fig. 14. The series method has the advantage of lower power dissipation, but it requires that the switching transistor have higher voltage and lower leakage than the shunt method requires. Fig. 15 illustrates the multiplexing of a one-of-ten gas-discharge display. Because of diode D1, the oscillator using the CD4011 produces a non-symmetrical output having an off period long enough to assure that all characters are deionized. **Fluorescent Displays**

The fluorescent display, like the LED, is a seven-segment device. Its operation is similar to that of a vacuum tube. The major difference is that the anode of the display has a phosphorescent coating which when struck by an electron beam emits blue-green light. Because this light is of a very wide spectrum, it can be filtered with little loss of display brightness. A positive potential of about 15

to 25 volts from anode to cathode is typically used to accelerate electrons emitted from the cathode. When the cathode is activated, the current flow is approximately 0.5 to 2 milliamperes depending upon the type of display.

The potentials of the anode, grid, and filament are crucial in the operation of the fluorescent display. The potential of the filament in the fluorescent display must be directly related to both the grid and anode voltages because the filament is acting both as a heater and as the cathode of the display. The potential at which the electrons are emitted from the cathode or filament, therefore, is critical in determining whether or not those electrons are accelerated toward the phosphor-coated anode.

Advantages of fluorescent display systems include low power, low cost, ease of multiplexing, and ease of interfacing to integrated circuits. A disadvantage is that they are more fragile than many other forms of display because they require an evacuated envelope.

A typical circuit for driving a fluorescent display is given in Fig. 16. The display segments are connected to the anodes of the display device and can be driven directly from any COS/MOS High-Voltage B-Series Integrated Circuit at about 20 volts. In many instances, however, the control logic for the information being displayed is operating at a voltage lower than the 20-volt display supply. In these cases, the CD40109B Quad Low-to-High Voltage Level Shifter can be used to interface the device.

In a multiplexed system, the grid or cathode of the fluorescent display device operates in a manner equivalent to the digit drive on LED devices. A typical grid voltage value necessary to activate the display is 10 volts. If a system is operating below 10 volts, it may be necessary to shift the voltage levels of both the segment and the digit information.

In an unmultiplexed system, the grid voltage should always be enabled to allow the display of the seven-segment information. An example of such a system is given in Fig. 17. Because the grid voltage is constant and not at the control of the system, the only possible level shifting necessary would be for the segment display.

Unlike the LED display, the fluorescent display quite often needs the level-shifting capability of a transistor-inductor flyback circuit to achieve the high potentials necessary for operation. Fig. 18 gives three typical up-converter circuits. The circuit of Fig. 18(a) is pulsed by VIN thus causing a current flow through L. This change in current causes an increase in the voltage across the inductor ( $V_L = L \cdot di/dt$ ). The amount of current ( $i_{peak} = V_{DD}/R_2$ ) is inversely proportional to the value of R2. With R2 adjustable in value, the output voltage can be increased by lowering the value of R2 or decreased by raising its value. Capacitor C2 filters the voltage spikes caused by the input frequency, and diode D1 keeps the capacitor charged while the voltage spike from L di/dt is low.

Fig. 18(b) differs from Fig. 18(a) in that it has a self-contained RCL oscillator and obtains its voltage increase by transformer action. The oscillator formed by R0, C, and L drives the n-p-n bipolar devices forcing an ac signal across the transformer input windings. Because the turns ratio of the transformer from output to input is greater than one, there is an increase in output voltage. The transformer gives a more precise increase in voltage than the circuit in Fig. 18(a) provides. Capacitor C and diodes D and DZ clamp the voltage VOUT to the breakdown voltage of DZ and filter and isolate C from discharging during the period of low output voltage from the transformer.

Fig. 18(c) is similar to Fig. 18(b) in the transformer action, but its input is similar

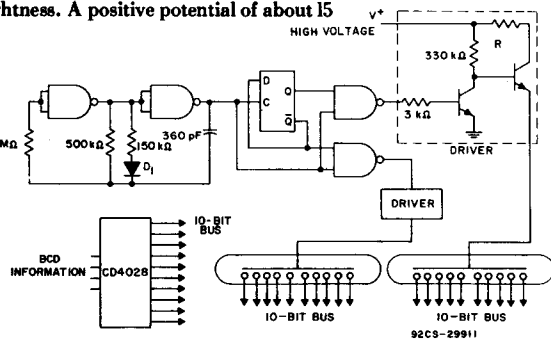

Fig. 15 - Series-type multiplexing of a one-of-ten gas-discharge display.

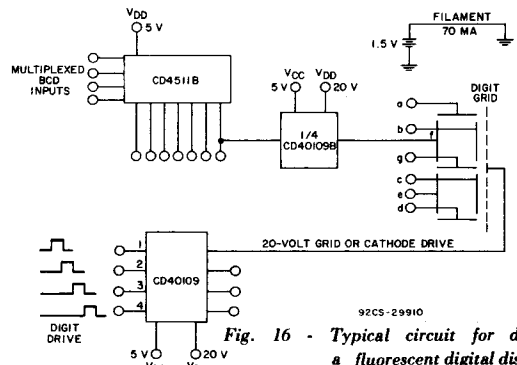

Fig. 16 - Typical circuit for driving a fluorescent digital display.



# Simplified Design of Astable RC Oscillators Using the CD4060B or Two CMOS Inverters

D. Rodman

Application Notes are available that deal with theoretical approaches to oscillator design; this Note stresses practical aspects of design and provides easy-to-use algebraic equations that permit values of R and C for a given oscillator frequency to be quickly determined.

### Astable Design Approach

The most basic RC oscillator circuit is that shown in Fig. 1. The time period T for one cycle of this oscillator is given by the equation:<sup>1</sup>

$$T = -RC \left[ \ln \frac{V_{DD} - V_{TR}}{V_{DD}} + \ln \frac{V_{TR}}{V_{DD}} \right] \quad (1)$$

where:

$V_{DD}$  = supply voltage  
 $V_{TR}$  = transfer voltage

By letting  $V_{TR} = 0.5 V_{DD}$ , equation 1 can be simplified to:

$$T = -RC (\ln 0.5 + \ln 0.5) \\ T = 1.39 RC \quad (2)$$

The problem with this circuit is that transfer voltage can vary from 33 to 67 percent of  $V_{DD}$ . Therefore, the maximum variation in the time period, T, can be as high as 9 percent, with a  $\pm 33$  percent variation in transfer voltage from unit to unit.

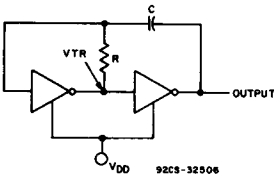

Fig. 1 - The most basic RC oscillator circuit.

An improvement to this basic circuit can be made by adding resistor  $R_S$ , as shown in Fig. 2. The resistor makes the frequency independent of supply-voltage variations and reduces the time-period variations to less than 5 percent with variations in transfer voltage.

$R_S$  should be 10 times the value of  $R_x$ . If  $R_S$  is made less than 10  $R_x$ , the variation in period T increases to about 10 percent as the value of  $R_S$  approaches zero.<sup>1</sup> If  $R_S$  is made too large, a time constant and phase shift is produced by  $R_S$  and stray wiring and breadboard capacitance. This shift creates a switching delay in the circuit which changes the time period.

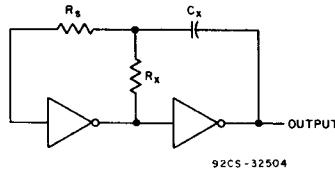

Fig. 2 - An improved oscillator circuit made by adding resistor  $R_S$  to the circuit of Fig. 1.

The time period T for the circuit in Fig. 2 is:<sup>1</sup>

$$T = -R_x C_x \left[ \ln \frac{V_{TR}}{V_{DD} + V_{TR}} + \ln \frac{V_{DD} - V_{TR}}{2 V_{DD} - V_{TR}} \right] \quad (3)$$

If  $V_{TR} = 0.5 V_{DD}$ , equation 3 can be simplified to:

$$T = -R_x C_x (\ln 1/2 + \ln 1/2) \\ T = 2.2 R_x C_x \quad (4)$$

Equation 4 will only be true in the CD4060B for values of R greater than 50 kilohms and for values of C greater than 1000 picofarads. At values of C less than 1000 picofarads, stray capacitance will have a much greater effect on the entire system.

It is advised that a buffer circuit, Fig. 3, be added to the circuit of Fig. 2 to prevent the jitter that would otherwise be introduced into the circuit by noise picked up by connecting cables and by stray wiring and breadboard capacitance. The buffer circuit is not needed with the CD4060B since it has an internal buffer and is internally connected to a counter.

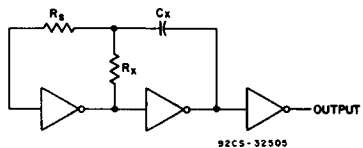

Fig. 3 - A buffer circuit used to improve the performance of the circuit of Fig. 2.

### Compensation for 50-Percent Duty Cycle

A true square-wave pulse is obtained only when the transfer voltage occurs at the 50-percent point. If the transfer voltage is at either 33 or 67 percent, the duty cycle will not be 50 percent. The duty cycle can be controlled, however, if part of the resistance of the RC time constant is shunted out with a diode, as shown in Fig. 4.

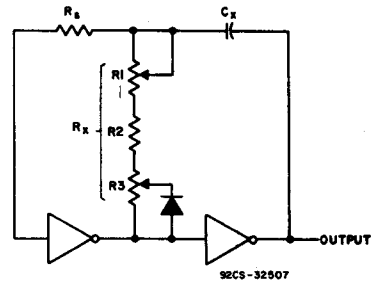

Fig. 4 - Method of controlling the duty cycle of the RC oscillator.

Because adjustment of this diode shunt to obtain a specific pulse factor causes the frequency of the circuit to stray, a frequency control, R1, is added. This circuit is not needed when using the CD4060B since it is used in conjunction with a counter. A 50-percent duty cycle will be derived from the divider/counter outputs.

### References and Bibliography

1. "Astable and Monostable Oscillators Using RCA COS/MOS Digital Integrated Circuits," RCA Solid State Application Note ICAN-6466.
2. "COS/MOS 14-Stage Ripple-Carry Binary Counter/Divider and Oscillator," RCA Solid State Data Bulletin File Number 1120.

# Parallel Clocking of Sequential CMOS Devices

T. Chesney

R. Funk

It is a well-established fact that process variations lead to different input MOS-transistor thresholds, and that these differences directly affect the clock input trigger voltage of sequential CMOS logic circuits. Fig. 1(a) illustrates a cascade of two different sequential CMOS devices (D-type flip-flops, type CD4013) that causes a logic error when data is transferred from IC<sub>A</sub> to IC<sub>B</sub>. In this example, the same clock transition triggers IC<sub>A</sub> at its trigger voltage of V<sub>TA</sub> and IC<sub>B</sub> at a voltage of V<sub>TB</sub>. As shown in Fig. 1(b), the propagation of data from the output stage of IC<sub>A</sub> to the input of IC<sub>B</sub> is faster than the clock transition time from V<sub>TA</sub> to V<sub>TB</sub>. Hence, IC<sub>B</sub> responds to the wrong logic state, and its output goes low when it should stay high.

The solution to this logic-error condition is a clock transition time that is fast enough compared to the propagation delay for a worst-case V<sub>TA</sub> and V<sub>TB</sub> combination to assure that logic-state errors will not occur.

### Parallel Clocking Limits

A study of the parallel clocking condition for any combination of two different sequential devices has resulted in the development of equations for modeling the maximum permitted clock input rise time, t<sub>RCL</sub>

For A-series devices:

$$t_{RCL}(\text{max}) = \frac{0.8V_{DD}(V)}{1.25(V)} \times t_p(\text{ns})$$

For B-series devices:

$$t_{RCL}(\text{max}) = \frac{0.8V_{DD}(V)}{1.15(V)} \times t_p(\text{ns})$$

The factor t<sub>p</sub> is equivalent to t<sub>PHL</sub> or t<sub>PLH</sub>, whichever is smaller, for IC<sub>A</sub>, Fig. 1. The typical value at a specified value of V<sub>DD</sub> is selected at the loading condition shown on the device data sheet. The factor 0.8 V<sub>DD</sub> specifies t<sub>RCL</sub> for a rise or fall time of from 10 to 90 percent. The voltages in the denominator (1.25V for A-series types and 1.15V for B-series types), are the expected deviations in clock input transfer voltages. Tables I and II list the maximum clock rise times permitted when cascading CD4000A and CD4000B-series types, respectively.

The maximum values of t<sub>RCL</sub> are applicable when sequentially cascading identical or dissimilar IC types when IC<sub>A</sub> (see Fig. 1) is the type listed in the "Type" column in the table. However, some restrictions apply; namely both IC<sub>A</sub> and IC<sub>B</sub> must accept positive or negative (CD4006 type) clock pulses, and the logic combination of IC<sub>A</sub> and IC<sub>B</sub> must be meaningful. The connections assumed are primarily of the parallel-clocked shift register or counter type.

The t<sub>RCL</sub> limits shown in Tables I and II are less than those shown on individual CD4000-series data sheets; the data sheet limits are for individual IC operation, not cascaded operation. Recommended operating-temperature ranges remain as shown in the data sheets for cascaded as well as individual device operation.

TABLE I — Maximum Clock Rise Time When Cascading CD4000A Types<sup>1</sup>

Type	Rise Time (μs)	V <sub>DD</sub> (V)
CD4006A <sup>2</sup>	0.80	5,10
CD4013A	0.48	5,10
CD4014A	0.96	5
	0.64	10
CD4015A	0.96	5
	0.64	10
CD4018A	1.12	5
	0.80	10
CD4021A	0.96	5
	0.64	10
CD4027A	0.48	5,10
CD4029A	1.04	5
	0.74	10
CD4031A	1.28	5,10
CD4034A	1.92	5
	1.54	10
CD4035A	0.80	5
	0.64	10

Notes:

- C<sub>L</sub> = 15 picofarads.
- Negative-edge-triggered device, cascades only with itself.

TABLE II — Maximum Clock Rise Time When Cascading CD4000B Types<sup>1</sup>

Type	Rise Time (μs)
CD4006B <sup>2</sup>	0.70
CD4013B	0.45
CD4014B	0.40
CD4015B	0.55
CD4021B	0.40
CD4027B	0.45
CD4029B	0.84
CD4031B	0.80
CD4034B	0.85
CD4035B	0.70
CD4076B	0.90
CD4089B	0.40
CD4094B	0.90
CD4095B	0.70
CD4096B	0.70
CD4510B	0.70
CD4516B	0.70
CD4517B	0.84
CD40100B	1.20
CD40102B	0.91
CD40103B	0.91
CD40104B	0.70
CD40160B	0.66
CD40161B	0.66
CD40162B	0.66
CD40163B	0.66
CD40174B	0.50
CD40192B	0.56
CD40193B	0.56
CD40194B	0.70

Notes:

- V<sub>DD</sub> = 5, 15V; C<sub>L</sub> = 50 picofarads. Data does not apply to units with Schmitt triggers in the clock input.
- Negative-edge-triggered device, cascades only with itself.

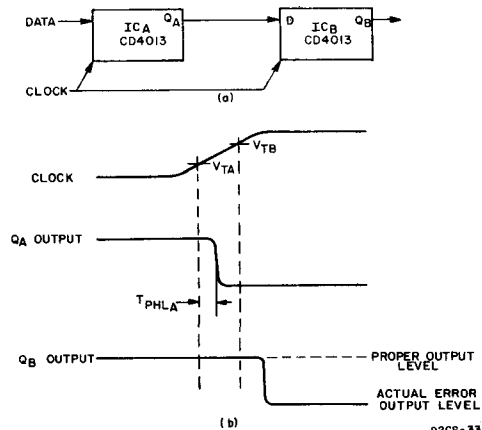

Fig.1-Parallel clocking of sequential CMOS ICs.

92CS-33-23



# Logarithmic Units Of Measure In Telecommunications

by Dennis Rodman

This Application Note is an introduction to the logarithmic units used in the telecommunications industry. The Note will be useful as a learning tool for those entering the telecommunications industry and as a handy reference for experienced individuals.

Logarithmic units are used in the telecommunications industry for measurements that define the functions and qualities of transmission circuits. Examples of measurements involving logarithmic units are gain, noise and distortion. Since common logarithms are based on exponents of powers of ten, the application of logarithms permits complex multiplication or division operations to be transformed into simple addition or subtraction. This property of logarithms is valuable in telecommunications because many measurements involve large numbers, and logarithms facilitate calculation of these numbers.

### Logarithms

The logarithm or "log" to a given base of a positive number is the exponent that indicates the power to which the base must be raised in order to obtain the number. In the example  $2^3 = 8$ , 3 is the exponent of 2 and is also the log of 8, or in other words, 3 is the log to the base 2 of 8. This expression is written as  $3 = \log_2 8$ . Base 10 is the most used system and is known as the "common logarithm." In the example  $10^2 = 100$ , 2 is the log to the base 10 of 100. The subscript 10 is usually eliminated and the equation becomes  $2 = \log 100$ , with the base 10 understood.

### Decibels

Power gains or losses are measured in decibels. The decibel is defined as:

$$dB = 10 \log \frac{P_O}{P_I}$$

where  $P_O$  is the output power and  $P_I$  the input power. Conversion of the power into voltage yields the equation:

$$dB = 20 \log \frac{V_O}{V_I}$$

where  $V_O$  is the output voltage and  $V_I$  the input voltage. If the output is greater than the input (gain), dB will always be a positive number. If the output is less than the input (attenuation), dB will always be a negative number. dB equals 0 when the input equals the output.

The decibel is never an absolute measurement, but rather a ratio between two quantities. Thus, the gain or attenuation of a system can be characterized without specifying input or output quantities. As an example, a system that has a gain of 20 dB will always have a power ratio of 100; i.e., the output power will be 100 times greater than the input power. A list of ratios is given in Table I.

Table I - Power Ratios for Various dB Values

dB	Power Ratio
0	1
1	1.26
2	1.58
3	2.00
4	2.51
5	3.16
6	3.98
7	5.01
8	6.31
9	7.94
10	10
15	31.6
20	100
25	316
30	1000
35	$3.16 \times 10^3$
40	$10^4$
45	$3.16 \times 10^4$
50	$10^5$
60	$10^6$
70	$10^7$
80	$10^8$
90	$10^9$
100	$10^{10}$

### dBm

In many instances, it is desirable to have a common reference power. In the telecommunications industry, the most common reference power is 1 milliwatt. When the 1 milliwatt reference figure is used, the equation for decibels becomes:

$$dBm = 10 \log \frac{P_O}{0.001}$$

where dBm is defined as decibels referenced to 1 milliwatt. As an example, a gain of 30 dBm would be equivalent to an output power of 1 watt.

When converting power into voltage in dBm, 1 milliwatt is always measured across 600 ohms. Then the input reference voltage becomes:

$$P(R) = V^2$$

$$(0.001)(600) = V^2$$

$$0.775 = V$$

Therefore, the expression for dBm when using voltage becomes:

$$dBm = 20 \log \frac{V_O}{0.775}$$

## ICAN-7037

### dBr

Gain and attenuation have no significance unless a reference level is defined for the system. The point at which the reference appears is designated the "zero test-level point," or 0 TLP. A 0 TLP is also equivalent to a 0 dBr point (dBr relative to transmission level). dBr indicates the difference between the point at which a measurement is taken and an established zero or reference level. That is:

$$dBr = 10 \log \frac{\text{measured power level}}{\text{reference power level}}$$

As an example, assume that 25 milliwatts will be used as the 0 TLP in a particular system. If a level of 10 milliwatts is measured, then:

$$dBr = 10 \log \frac{0.010}{0.025}$$

$$dBr = -4$$

Thus, the 10-milliwatt signal would be at a -4 dBr point with reference to 25 milliwatts.

### dBmO

When a power level measured in dBm is referred or measured to a 0 TLP, it is converted into dBmO, where the "O" indicates that the measurement is referred to a point of zero relative level. The unit dBmO is an absolute unit of power in dBm. dBm can be related to dBr and dBmO by the following equation:

$$dBmO = dBm - dBr$$

As an example, assume that 8 dBm will be used as the 0 TLP or 8 dBmO. A signal is then measured at -12 dBm. To calculate the dBr point, the values are substituted into the equation:

$$dBmO = dBm - dBr$$

$$8 = -12 - dBr$$

$$-20 = dBr$$

Therefore, -12 dBm is at a -20 dBr point when 8 dBm is used as the 0 TLP.

This unit, dBmO, is used extensively in telecommunications for recording results of such tests as gain, gain tracking, and frequency response.

dBm and dBmO are generally intended as power measurements at a given point. However, many power measurements in the telecommunications industry are referenced to noise. The following is a discussion of these units.

### dBm

In order to develop a unit of measure for noise interference, both the response of the human ear and the efficiency of the telephone equipment used had to be considered. It was found that a frequency of 1000 Hz produced greater interference for the average listener than any other frequency. The designers of the early-model Western Electric 144 handset used this fact to produce a weighting curve, Fig. 1, that showed the interference effect of frequencies in the voice band as compared to 1000 Hz. The 144 weighting curve shows that 500 Hz causes 15 dB less interference than a 1000 Hz signal of the same amplitude, 10 dB at 600 Hz, 6 dB at 800 Hz and so on.

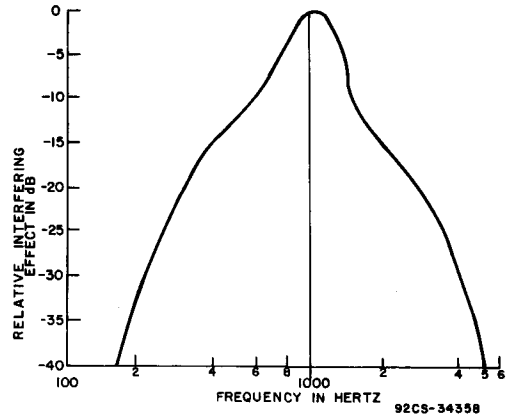

Fig. 1 - Weighting curve used with Western Electric 144 handset.

The noise-measurement referred to the 144 handset was the dBm (dB referenced to noise). The reference power selected was 1 picowatt ( $10^{-12}$  watt), or -90 dBm at 1000 Hz. dBm can then be expressed as:

$$dBm = 10 \log \frac{\text{(noise signal)}}{10^{-12}}$$

or

$$dBm = dBn + 90$$

### dBa

Subsequent to the 144 handset, Western Electric developed an improved handset, the F1A. This new handset had a broader response than the 144, but was 5 dB less sensitive at 1000 Hz. That is, the same interfering effect was produced using -85 dBm with the F1A weighting as was produced using -90 dBm with the 144 weighting. Thus, a new noise unit known as dBa (decibels above reference noise, adjusted) was adopted. This noise unit uses a reference power of -85 dBm at 1000 Hz. dBa is expressed as:

$$dBa = dBm + 85$$

### dBmC and dBmC0

In the 1950's, a third, more sensitive handset, the type 500, was put into service in North America. This handset produced yet another weighting curve called "C-message weighting," Fig. 2. The C-message weighting curve is 3.5 dB more sensitive at the reference frequency than the F1A curve, and 1.5 dB less sensitive than the 144 weighting curve. However, instead of creating a new reference power level of -88.5 dBm, the -90 dBm level was maintained. The new noise unit became dBmC (decibels above reference noise, C-message weighted), and can be expressed as:

$$dBmC = dBm + 90$$

When noise measurements are taken with a 3000-Hz bandwidth (white noise), the level of interference changes. White noise, having a power of 0 dBm, produces an interference of only 82 dBa or 88 dBmC. Therefore, the conversion from dBmC to dBa is given by:

$$dBmC = dBa + 6 \text{ dB}$$

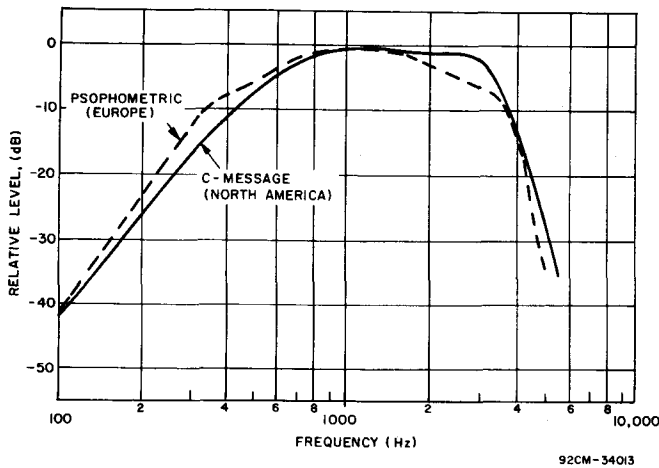

Fig. 2 - Comparison of psophometric with C-message weighting.

where the conversion factor has a 5 dB difference, and weighting over the 3000-Hz bandwidth adds 1 dB of difference.

It becomes convenient at times to refer an absolute noise power measurement to a known noise-power level. The zero transmission point (0 TLP) is then used and identified as dBrnC0 where:

$$dBrnC0 = dBrnC - dBr$$

and

$$dBrnC0 = dBm + 90 - dBr$$

As an example, 0 dBr is used as the reference. Noise is then measured at -82 dBm. To calculate the dBrnC0, the values are substituted into the equation above:

$$dBrnC0 = dBm + 90 - dBr$$

$$= -82 + 90 - 0$$

$$dBrnC0 = 8$$

Therefore, noise at -82 dBm is equivalent to 8 dBrnC0. dBrnC0 is used in test documentation and data sheets to describe idle-channel noise. It gives the advantage of the use of a small positive number rather than a large negative number.

**Psophometric Weighting**

In Europe and other parts of the world, CCITT (International Telephone and Telegraph Consultative Committee) has established the psophometric weighting curve as the standard for noise measurements, Fig. 2. The reference frequency used for this weighting is 800 Hz rather than the previously mentioned 1000 Hz.

dBmP (dBm psophometrically weighted) is the unit of power in dBm measured with psophometric weighting. The reference level is 1 picowatt and is designated as 1 pWp (picowatt psophometrically weighted), which is equivalent to an 800-Hz signal at -90 dBm. Approximate conversions are as follows:

$$dBrnC = 10 \log pWp$$

For flat noise in the 300-3400-Hz frequency range:

$$dBmP = dBa - 84$$

$$dBa = 10 \log pWp - 6$$

A list of dB measurements is given in Table II.

Table II - dB Conversions

Power (W)	dBm	dBrn	dBa	dBrnC	dBmP
10	40	130	125	130	40
1	30	120	115	120	30
0.1	20	110	105	110	20
10 <sup>-2</sup>	10	100	95	100	10
10 <sup>-3</sup>	0	90	85	90	0
10 <sup>-4</sup>	-10	80	75	80	-10
10 <sup>-5</sup>	-20	70	65	70	-20
10 <sup>-6</sup>	-30	60	55	60	-30
10 <sup>-7</sup>	-40	50	45	50	-40
10 <sup>-8</sup>	-50	40	35	40	-50
10 <sup>-9</sup>	-60	30	25	30	-60
10 <sup>-10</sup>	-70	20	15	20	-70
10 <sup>-11</sup>	-80	10	5	10	-80
10 <sup>-12</sup>	-90	0	-5	0	-90

**References**

1. Donald G. Fink, **Electronics Engineers' Handbook**, McGraw-Hill, New York, 1975.
2. Roger L. Freeman, **Telecommunication System Engineering**, Wiley New York, 1980.
3. Lenkurt Demodulator, Lenkurt Electric Company, San Carlos, California, September/October 1976.
4. **International Telephone and Telegraph Corporation, Reference Data for Radio Engineers**, 6th ed., Howard W. Sam, Indianapolis, 1976.

## Abstracts of Other Application Notes

### ICAN-6080 . . . . . 6 pages Digital-to-Analog Conversion Using the RCA-CD-4007A COS/MOS IC

The use of the RCA-CD4007A COS/MOS dual complementary pair plus inverter as a digital-to-analog (D/A) switch is demonstrated. The op-amp output stage for the digital-to-analog converter (DAC) uses COS/MOS and bipolar transistor-array IC's. Resistance networks for DAC's, the design of a voltage-follower amplifier for single supply operation, and a 9-bit COS/MOS DAC are described.

### ICAN-6166 . . . . . 16 pages COS/MOS MSI Counter and Register Design and Applications

Logic and schematic diagrams for counter and register types CD4006A, CD4014A, CD4015A, CD4018A, CD4020A, CD4021A, CD4022A, and CD4024A are presented; circuit designs are outlined and device-design trade-off's are discussed. Performance criteria are summarized and applications by type are outlined by means of logic or subsystems diagrams and waveforms photographs.

### ICAN-6176 . . . . . 8 pages Noise Immunity of COS/MOS Integrated-Circuit Logic Gates

The types of noise usually encountered in a logic system are discussed and the noise immunity of a COS/MOS integrated-circuit logic-gate test circuit in relation to system variables is evaluated. The evaluation is performed on a circuit that includes a CD4000A dual 3-input gate plus inverter and a CD4001A quad 2-input gate connected in cascade to drive a CD4013A flip-flop. Measurement of the voltage required at various gate leads to switch the flip-flop defines the noise immunity threshold of the gate circuits.

### ICAN-6210 . . . . . 11 pages A Typical Data-Gathering and Processing System Using CD4000A-Series COS/MOS Parts

This Note is developed in terms of a typical system for process controls. The flexibility of system design and common data-bus architecture made possible by the three-state outputs and bidirectional input/outputs incorporated in many COS/MOS circuits are stressed, as is the ease of system design for data handling in increments of 4 bits made possible by the CD4000A family. The implementation of the system is shown in terms of the COS/MOS standard parts that can be used to perform the desired system functions. Attention is focused on the multiplicity of applications and the scope of information processing that can be covered by standard parts.

### ICAN-6289 . . . . . 12 pages A COS/MOS PCM Telemetry and Remote Data Acquisition Design

Descriptive background material on telemetry systems is given along with systems for both immediate and remote data conversion

and transmission. Parts from the CD4000 family are used to show how various sections of the system may be realized in the general case. The exact configuration of any specific system will, of course, depend on the unique requirements of the application.

### ICAN-6362 . . . . . 10 pages Using the CD4520B to Design Dividers with Symmetrical Outputs

The general-purpose COS/MOS dual up-counter, the CD4520B, a counter that may be used in various counting and dividing applications is discussed. Dividers of the form  $N=2^i \pm 1$  and  $N=2^i \pm 1$  and described. Applications of symmetrical dividers are also discussed.

### ICAN-6374 . . . . . 8 pages The COS/MOS CD4059A Programmable Divide-by-N Counter in FM and Citizens-Band-Transceiver Tuners

The frequency synthesis capability of the CD4059A programmable divide-by-N counter is demonstrated in applications in an FM digital tuner and in the digital tuner for a citizens-band transceiver. The digital approach described in the paper allows desired frequencies to be selected by depressing numbered buttons on a keyboard. By using the appropriate basic circuitry along with a phase-locked-loop circuit, the local oscillator of the receiver is adjusted and locked to the proper frequency, thus assuring proper station selection. Alternate methods of station selection that enhance the flexibility of the system are described.

### ICAN-6498 . . . . . 6 pages Design of Fixed and Programmable Counters Using the RCA CD4018A COS/MOS Presettable Divide-by-N Counter

The use of the CD4018A single-decade and multidecade fixed and programmable divide-by-N counters are described. System considerations such as switch simplifications, components minimization, and speed are also discussed.

### ICAN-6600 . . . . . 6 pages Arithmetic Arrays Using Standard COS/MOS Building Blocks

The design of a COS/MOS arithmetic unit capable of adding, subtracting, multiplying, and dividing is described. The device is also able to perform the logical functions of OR, AND and the Exclusive OR of two 4-bit words. Three 4-bit registers are provided that permit either of two words to perform a desired operation with a third word. The system is configured with standard, commercially available COS/MOS devices, which include registers, AND-OR select gates, a full adder, and NOR and NAND gates.

### ICAN-6601 . . . . . 12 pages Transmission and Multiplexing of Analog or Digital Signals Utilizing the CD4016A Quad Bilateral Switch

The CD4016A quad bilateral switch is the

ideal semiconductor switch for use in switching applications; it can be used for the transmission of analog or digital signals with low distortion. The Note discusses features of the device; operation of the COS/MOS switch; switch and logic applications, including switch and logic functions; multiplexing/demultiplexing; digital control of signal gain, frequency, and impedance, including resistor networks, and variable frequency control; digital-to-analog conversion, including weighted resistor networks for the D/A converter, and an R-2R resistor ladder D/A converter; sample-and-hold applications; and squelch control (level detection).

### ICAN-6602 . . . . . 12 pages Interfacing COS/MOS with Other Logic Families

The RCA CD4000A COS/MOS series circuits operate from power-supplies of 3 to 15 volts. Thus, they can drive and be driven by a number of logic families, including all DTL and TTL families, within certain conditions and limitations. This Note describes the conditions of interface.

### ICAN-6716 . . . . . 15 pages Low-Power Digital Frequency Synthesizers Utilizing COS/MOS IC's

A digital frequency synthesizer that employs a digital phase-locked loop and other COS/MOS circuits is described. Following a review of phase-locked-loop fundamentals, the use of COS/MOS devices in FM receiver synthesizers is discussed.

### ICAN-6733 . . . . . 16 pages Battery-Powered Digital-Display Clock/Timer and Metering Applications Utilizing the RCA CD4026A and CD4033A Decode Counters - 7 Segment Output Types

This Note describes the CD4033A and CD4026A and their use with various 7-segment display units presently available. Interface packages and methods are discussed to help the designer select the best system to meet his demands. Also included are battery-operated systems for digital clocks and watches.

### ICAN-6739 . . . . . 12 pages COS/MOS Rate Multipliers - Versatile Circuits for Synthesizing Digital Functions

COS/MOS rate multipliers, the CD4527B and CD4089B, can be used as building blocks to generate a range of digital functions in low-power systems where minimum package count is desirable. The circuits may be employed in numerical control, instrumentation, digital filtering, and frequency synthesis. When used with an up/down counter and control logic, they can be used to perform such operations as multiplication, addition, subtraction, generation of algebraic equations and differential equations, integration, and to raise numbers to various powers. Symmetric rate multiplication, the problem of eliminating round-off error in a direct frequency-synthesis application in a common-carrier multiplex system is also covered.

---

**RCA Sales Offices,  
Authorized Distributors, and  
Manufacturers'  
Representatives**

## RCA Sales Offices

### U.S. and Canada

#### U.S.

#### Alabama

**RCA**  
Suite 133  
303 Williams Avenue,  
Huntsville, AL 35801  
Tel: (205) 533-5200

#### Arizona

**RCA**  
6900 E. Camelback Road, Suite  
460, Scottsdale, AZ 85251  
Tel: (602) 947-7235

#### California

**RCA**  
4546 El Camino Real,  
Los Altos, CA 94022  
Tel: (415) 948-8996  
**RCA**  
4827 No. Sepulveda Blvd., Suite  
420, Sherman Oaks, CA 91403  
Tel: (213) 468-4200

**RCA**  
17731 Irvine Blvd., Suite 104  
Magnolia Plaza Bldg., Tustin,  
CA 92680  
Tel: (714) 832-5302

#### Colorado

**RCA Corp.**  
6767 So. Spruce Street  
Englewood, CO 80112  
Tel: (303) 740-8441

#### Florida

**RCA**  
P.O. Box 12247, Lake Park, FL  
33403  
Tel: (305) 626-6350

#### Illinois

**RCA**  
2700 River Road, Des Plaines  
IL 60018  
Tel: (312) 391-4380

#### Indiana

**RCA**  
9240 N. Meridian Street, Suite  
102, Indianapolis, IN 46260  
Tel: (317) 267-6375

#### Kansas

**RCA**  
8900 Indian Creek Parkway,  
Suite 410,  
Overland Park, KS 66210  
Tel: (913) 642-7656

#### Massachusetts

**RCA**  
20 William Street, Wellesley,  
MA 02181  
Tel: (617) 237-7970

#### Michigan

**RCA**  
30400 Telegraph Road, Suite  
440, Birmingham, MI 48010  
Tel: (313) 644-1151

#### Minnesota

**RCA**  
6750 France Avenue, So., Suite  
122, Minneapolis, MN 55435  
Tel: (612) 929-0676

#### New Jersey

**RCA**  
1998 Springdale Road,  
Cherry Hill, NJ 08003  
Tel: (609) 338-5042

**RCA**  
67 Walnut Avenue, Clark, NJ  
07066  
Tel: (201) 574-3550

#### New York

**RCA**  
160 Perinton Hill Office Park  
Fairport, NY 14450  
Tel: (716) 223-5240

#### Ohio

**RCA**  
6600 Busch Blvd., Suite 110,  
Columbus, OH 43229  
Tel: (614) 436-0036

#### Tennessee

**RCA**  
1111 Northshore Drive,  
Northshore Center 2,  
Suite 405,  
Knoxville, TN 37919  
Tel: (615) 588-2467

#### Texas

**RCA Center**  
4230 LBJ at Midway Road  
Town No. Plaza, Suite 121  
Dallas, TX 75234  
Tel: (214) 661-3515

#### Virginia

**RCA**  
1901 N. Moore Street  
Arlington, VA 22209  
Tel: (703) 558-4161

#### Canada Alberta

**RCA Inc.**  
6303 30th Street, SE,  
Calgary, Alberta T2C 1R4  
Tel: (403) 279-3384

#### Quebec

**RCA Inc.**  
21001 Trans-Canada Highway,  
St. Anne-de-Bellevue,  
Quebec H9X 3L3  
Tel: (514) 457-2185

#### Ontario

**RCA Inc.**  
1 Vulcan Street, Rexdale,  
Ontario M9W 1L3  
Tel: (416) 247-5491

### Europe

#### Belgium

**RCA S.A.**  
Mercure Centre, Rue de la  
Fusee 100, 1130 Bruxelles  
Tel: 02/720.89.80

#### France

**RCA S.A.**  
2-4 Avenue de L'Europe  
78140 Velizy  
Tel: (3) 946.56.56

#### Germany

**RCA GmbH**  
Pfungstrosenstrasse 29,  
8000 Munchen 70  
West Germany  
Tel: 089/7143047-49  
**RCA GmbH**  
Justus-von-Liebig-Ring 10  
2085 Quickborn  
West Germany  
Tel: 04106/613-0  
**RCA GmbH**  
Zeppelinstrasse 35,  
7302 Ostfildern 4 (Kemnat)  
West Germany  
Tel: 0711/454001-64

#### Italy

**RCA SpA**  
Piazza San Marco 1  
20121 Milano  
Tel: (02) 65.97.048-051

#### Sweden

**RCA International LTD**  
Box 3047, Hagalundsgatan 8  
171 03 Solna 3  
Tel: 08/83 42 25

#### U.K.

**RCA LTD**  
Lincoln Way, Windmill Road  
Sunbury-on-Thames  
Middlesex TW16 7HW  
Tel: 093 27 85511

### Asia Pacific

#### Hong Kong

**RCA International, Ltd.**  
13th Floor, Fourseas Bldg.  
208-212 Nathan Road  
Tsimshatsui, Kowloon  
Tel: 852-3-7236339

#### Singapore

**RCA International, Ltd.**  
Solid State Division, 24-15 Inter-  
national Plaza, 10 Anson Road,  
Singapore 0207  
Tel: 2224156/2224157

#### Taiwan

**RCA Corporation**  
Solid State Division,  
7th Floor, 97  
Nanking East Road, Section 2  
Taipei  
Tel: (02) 521-8537

### Latin America

#### Argentina

**Ramiro E. Podetti Reps.**  
Lavalle 357  
3rd Floor, Office No. 24  
1047 Buenos Aires  
Tel: 393-3919

#### Brazil

**RCA Solid State Limitada**  
Av. Brig Faria Lima 1476  
7th Floor, Sao Paulo 01452  
Tel: 210-4033

#### Mexico

**RCA S.A. de C.V./**  
Solid State Div., Avenida  
Cuitlahuac 2519, Apartado  
Postal 17-570, Mexico 16, D.F.  
Tel: (985) 399-7228

# RCA Authorized Distributors

## U.S. and Canada

U.S.

### ALABAMA

**Hamilton Avnet Electronics**  
4692 Commercial Drive, NW  
Huntsville, AL 35805  
Tel: (205) 837-7210

### ARIZONA

**Hamilton Avnet Electronics**  
505 South Madison Drive  
Tempe, AZ 85281  
Tel: (602) 231-5100

**Kierulff Electronics, Inc.**  
4134 East Wood Street  
Phoenix, AZ 85040  
Tel: (602) 243-4101

**Kierulff Electronics, Inc.**  
1806 West Grant Road, Suite 102,  
Tucson, AZ 85705  
Tel: (602) 624-9986

**Sterling Electronics, Inc.**  
2001 East University Drive,  
Phoenix, AZ 85034  
Tel: (602) 258-4531

**Wyle Distribution Group**  
8155 North 24th Avenue  
Phoenix, AZ 85021  
Tel: (602) 249-2232

### CALIFORNIA

**Arrow Electronics, Inc.**  
9511 Ridge Haven Court  
San Diego, CA 92123  
Tel: (714) 565-6928

**Arrow Electronics, Inc.**  
521 Weddell Drive  
Sunnyvale, CA 94086  
Tel: (408) 745-6600

**Arrow Electronics, Inc.**  
19748 Dearborn Street  
North Ridge Business Center  
Chatsworth, CA 91311  
Tel: (213) 701-7500

**Avnet Electronics**  
350 McCormick Avenue  
Costa Mesa, CA 92626  
Tel: (714) 754-6051

**Avnet Electronics**  
21050 Erwin Street  
Woodland Hills, CA 91367  
Tel: (213) 884-3333

**Hamilton Avnet Electronics**  
3170 Pullman Street  
Costa Mesa, CA 92626  
Tel: (714) 641-4107

**Hamilton Avnet Electronics**  
1175 Bordeaux Drive  
Sunnyvale, CA 94086  
Tel: (408) 743-3300

**Hamilton Avnet Electronics**  
4545 Viewridge Avenue  
San Diego, CA 92123  
Tel: (714) 571-7510

**Hamilton Electro Sales**  
10912 W. Washington Blvd.  
Culver City, CA 90230  
Tel: (213) 558-2121

**Hamilton Avnet Electronics**  
4103 Northgate Boulevard,  
Sacramento, CA 95834  
Tel: (916) 920-3150

**Kierulff Electronics, Inc.**  
2585 Commerce Way  
Los Angeles, CA 90040  
Tel: (213) 725-0325

**Kierulff Electronics, Inc.**  
3969 E. Bayshore Road  
Palo Alto, CA 94303  
Tel: (415) 968-6292

**Kierulff Electronics, Inc.**  
8797 Balboa Avenue  
San Diego, CA 92123  
Tel: (714) 731-5711

**Kierulff Electronics, Inc.**  
14101 Franklin Avenue  
Tustin, CA 92680  
Tel: (714) 731-5711

**Schweber Electronics Corp.**  
17822 Gillette Avenue  
Irvine, CA 92714  
Tel: (714) 863-0200

**Schweber Electronics Corp.**  
3110 Patrick Henry Drive  
Santa Clara, CA 95050  
Tel: (408) 748-4700

**Wyle Distribution Group**  
124 Maryland Avenue  
El Segundo, CA 90245  
Tel: (213) 322-8100

**Wyle Distribution Group**  
9525 Chesapeake Drive  
San Diego, CA 92123  
Tel: (714) 565-9171

**Wyle Distribution Group**  
3000 Bowers Avenue  
Santa Clara, CA 95052  
Tel: (408) 727-2500

**Wyle Distribution Group**  
17872 Cowan Avenue  
Irvine, CA 92714  
Tel: (714) 863-9953

**Wyle Distribution Group**  
18910 Teller Avenue  
Irvine, CA 92715  
Tel: (714) 851-9958

### COLORADO

**Arrow Electronics Inc.**  
1390 So. Potomac Street  
Suite 136  
Aurora, CO 80012  
Tel: (303) 696-1111

**Hamilton Avnet Electronics**  
8765 E. Orchard Road, Suite  
708, Englewood, CO 80111  
Tel: (303) 740-1000

**Kierulff Electronics, Inc.**  
7060 So. Tucson Way  
Englewood, CO 80112  
Tel: (303) 790-4444

**Wyle Distribution Group**  
451 East 124th Avenue  
Thornton, CO 80241  
Tel: (303) 457-9953

### CONNECTICUT

**Arrow Electronics, Inc.**  
12 Beaumont Road  
Wallingford, CT 06492  
Tel: (203) 265-7741

**Hamilton Avnet Electronics**  
Commerce Drive, Commerce  
Industrial Park,  
Danbury, CT 06810  
Tel: (203) 797-2800

**Kierulff Electronics, Inc.**  
169 North Plains Industrial Road  
Wallingford, CT 06492  
Tel: (203) 265-1115

**Schweber Electronics Corp.**  
Finance Drive,  
Commerce Industrial Park,  
Danbury, CT 06810  
Tel: (203) 792-3500

### FLORIDA

**Arrow Electronics, Inc.**  
1001 NW 62nd Street, Suite  
108, Ft. Lauderdale, FL 33309  
Tel: (305) 776-7790

**Arrow Electronics, Inc.**  
50 Woodlake Dr., West-Bldg. B  
Palm Bay, FL 32905  
Tel: (305) 275-1480

**\*Chip Supply**  
1607 Forsythe Road  
Orlando, FL 32807  
Tel: (305) 275-3810

**Hamilton Avnet Electronics**  
6801 NW 15th Way  
Ft. Lauderdale, FL 33068  
Tel: (305) 971-2900

**Hamilton Avnet Electronics**  
3197 Tech Drive, No.  
St. Petersburg, FL 33702  
Tel: (813) 576-3930

**Kierulff Electronics, Inc.**  
3247 Tech Drive  
St. Petersburg, FL 33702  
Tel: (813) 576-1966

**Milgray Electronics, Inc.**  
1850 Lee World Center  
Suite 104  
Winter Park, FL 32789  
Tel: (305) 647-5747

**Schweber Electronics Corp.**  
2830 North 28th Terrace  
Hollywood, FL 33020  
Tel: (305) 927-0511

### GEORGIA

**Arrow Electronics, Inc.**  
2979 Pacific Drive  
Norcross, GA 30071  
Tel: (404) 449-8252

**Hamilton Avnet Electronics**  
5825D Peach Tree Corners  
Norcross, GA 30092  
Tel: (404) 447-7503

**Schweber Electronics Corp.**  
303 Research Drive  
Suite 210  
Norcross, GA 30092  
Tel: (404) 449-9170

### ILLINOIS

**Arrow Electronics, Inc.**  
2000 Algonquin Road  
Schaumburg, IL 60193  
Tel: (312) 397-3440

**Hamilton Avnet Electronics**  
1130 Thorndale Avenue  
Bensenville, IL 60106  
Tel: (312) 860-7700

\*Chip distributor only.

## RCA Authorized Distributors U.S. and Canada (Cont'd)

### U.S. ILLINOIS

**Kierulff Electronics, Inc.**  
1536 Landmeier Road  
Elk Grove Village, IL 60007  
Tel: (312) 640-8200

**Newark Electronics**  
500 North Pulaski Road  
Chicago, IL 60624  
Tel: (312) 638-4411

**Schweber Electronics Corp.**  
904 Cambridge Drive  
Elk Grove Village, IL 60007  
Tel: (312) 364-3750

### INDIANA

**Arrow Electronics, Inc.**  
2718 Rand Road  
Indianapolis, IN 46241  
Tel: (317) 243-9353

**Graham Electronics Supply, Inc.**  
133 S. Pennsylvania Street  
Indianapolis, IN 46204  
Tel: (317) 634-8202

**Hamilton Avnet Electronics, Inc.**  
485 Gradle Drive  
Carmel, IN 46032  
Tel: (317) 844-9333

### KANSAS

**Hamilton Avnet Electronics**  
9219 Quivira Road  
Overland Park, KS 66215  
Tel: (913) 888-8900

**Milgray Electronics, Inc.**  
6901 W. 63rd Street  
Overland Park, KS 66215  
Tel: (913) 236-8800

### LOUISIANA

**Sterling Electronics, Inc.**  
3005 Harvard St., Suite 101  
Metairie, LA 70002  
Tel: (504) 887-7610

### MARYLAND

**Arrow Electronics, Inc.**  
4801 Benson Avenue  
Baltimore, MD 21227  
Tel: (301) 247-5200

**Hamilton Avnet Electronics**  
6822 Oakhill Lane  
Columbia, MD 21045  
Tel: (301) 995-3500

**Pytronic Industries, Inc.**  
Baltimore/Washington Ind.Pk.  
8220 Wellmoor Court  
Savage, MD 20863  
Tel: (301) 792-0780

**Schweber Electronics Corp.**  
9218 Gaithers Road  
Gaithersburg, MD 20877  
Tel: (301) 840-5900

**Zebra Electronics, Inc.**  
2400 York Road  
Timonium, MD 21093  
Tel: (301) 252-6576

### MASSACHUSETTS

**Arrow Electronics, Inc.**  
Arrow Drive  
Woburn, MA 01801  
Tel: (617) 933-8130

**Hamilton Avnet Electronics**  
50 Tower Office Park  
Woburn, MA 01801  
Tel: (617) 935-9700

\***Hybrid Components Inc.**  
140 Elliot Street  
Beverly, MA 01915  
Tel: (617) 927-5820

**Kierulff Electronics, Inc.**  
13 Fortune Drive  
Billerica, MA 01821  
Tel: (617) 667-8331

**A. W. Mayer Co.**  
34 Linnell Circle  
Billerica, MA 01821  
Tel: (617) 229-2255

**Schweber Electronics Corp.**  
25 Wiggins Avenue  
Bedford, MA 01730  
Tel: (617) 275-5100

\***Sertech**  
One Peabody Street  
Salem, MA 01970  
Tel: (617) 745-2450

**Sterling Electronics, Inc.**  
411 Waverly Oaks Road  
Waltham, MA 02154  
Tel: (617) 894-6200

### MICHIGAN

**Arrow Electronics, Inc.**  
3810 Varsity Drive  
Ann Arbor, MI 48104  
Tel: (313) 971-8220

**Hamilton Avnet Electronics**  
2215 29th Street  
Grand Rapids, MI 49503  
Tel: (616) 243-8805

**Hamilton Avnet Electronics**  
32487 Schoolcraft Road  
Livonia, MI 48150  
Tel: (313) 522-4700

**Schweber Electronics Corp.**  
12060 Hubbard Avenue  
Livonia, MI 48150  
Tel: (313) 525-8100

### MINNESOTA

**Arrow Electronics, Inc.**  
5230 West 73rd Street  
Edina, MN 55435  
Tel: (612) 830-1800

**Hamilton Avnet Electronics**  
10300 Bren Road, East  
Minnetonka, MN 55343  
Tel: (612) 932-0600

**Kierulff Electronics, Inc.**  
7667 Cahill Road  
Edina, MN 55435  
Tel: (612) 941-7500

**Schweber Electronics Corp.**  
7422 Washington Avenue, So.  
Eden Prairie, MN 55344  
Tel: (612) 941-5280

### MISSOURI

**Arrow Electronics, Inc.**  
2380 Schuetz Road  
St. Louis, MO 63141  
Tel: (314) 567-6888

**Hamilton Avnet Electronics**  
13743 Shoreline Court East  
Earth City, MO 63045  
Tel: (314) 344-1200

**Kierulff Electronics, Inc.**  
2608 Metro Park Boulevard  
Maryland Heights, MO 63043  
Tel: (314) 739-0855

### NEW HAMPSHIRE

**Arrow Electronics, Inc.**  
One Perimeter Drive  
Manchester, NH 03103  
Tel: (603) 668-6968

### NEW JERSEY

**Arrow Electronics, Inc.**  
Pleasant Valley Avenue  
Moorestown, NJ 08057  
Tel: (609) 235-1900

**Arrow Electronics, Inc.**  
Two Industrial Road  
Fairfield, NJ 07006  
Tel: (201) 575-5300

**Hamilton Avnet Electronics**  
Ten Industrial Road  
Fairfield, NJ 07006  
Tel: (201) 575-3390

**Hamilton Avnet Electronics**  
One Keystone Avenue  
Cherry Hill, NJ 08003  
Tel: (609) 424-0110

**Kierulff Electronics, Inc.**  
37 Kulick Road  
Fairfield, NJ 07006  
Tel: (201) 575-6750

**Schweber Electronics Corp.**  
18 Madison Road  
Fairfield, NJ 07006  
Tel: (201) 227-7880

### NEW MEXICO

**Arrow Electronics, Inc.**  
2460 Alamo, SE  
Albuquerque, NM 87106  
Tel: (505) 243-4566

**Hamilton Avnet Electronics**  
2524 Baylor S.E.  
Albuquerque, NM 87106  
Tel: (505) 765-1500

**Sterling Electronics, Inc.**  
3540 Pan American  
Freeway, N.E.  
Albuquerque, NM 87107  
Tel: (505) 884-1900

### NEW YORK

**Arrow Electronics, Inc.**  
20 Oser Avenue  
Hauppauge, L.I., NY 11788  
Tel: (516) 231-1000

**Arrow Electronics, Inc.**  
7705 Maltlage Drive  
Liverpool, NY 13088  
Tel: (315) 652-1000

**Arrow Electronics, Inc.**  
25 Hub Drive  
Melville, LI, NY 11747  
Tel: (516) 391-1640

**Arrow Electronics, Inc.**  
3000 South Winton Road  
Rochester, NY 14623  
Tel: (716) 275-0300

\*Chip distributor only.



# RCA Authorized Distributors U.S. and Canada (Cont'd)

## U.S. NEW YORK

**Hamilton Avnet Electronics**  
Five Hub Drive  
Melville, L.I., NY 11746  
Tel: (516) 454-6000

**Hamilton Avnet Electronics**  
333 Metro Park  
Rochester, NY 14623  
Tel: (716) 475-9130

**Hamilton Avnet Electronics**  
16 Corporate Circle  
East Syracuse, NY 13057  
Tel: (315) 437-2641

**Milgray Electronics, Inc.**  
191 Hanse Avenue  
Freeport, L.I., NY 11520  
Tel: (516) 546-5600

**Schweber Electronics Corp.**  
Three Townline Circle  
Rochester, NY 14623  
Tel: (716) 424-2222

**Schweber Electronics Corp.**  
Jericho Turnpike  
Westbury, L.I., NY 11590  
Tel: (516) 334-7474

**Summit Distributors, Inc.**  
916 Main Street  
Buffalo, NY 14202  
Tel: (716) 884-3450

## NORTH CAROLINA

**Arrow Electronics, Inc.**  
5240 Greensdairy Road  
Raleigh, NC 27604  
Tel: (919) 876-3132

**Hamilton Avnet Electronics**  
3510 Spring Forest Road  
Raleigh, NC 27604  
Tel: (919) 878-0810

**Kierulff Electronics Inc.**  
1 North Commerce Center  
5249 North Boulevard  
Raleigh, NC 27604  
Tel: (919) 872-8410

**Schweber Electronics Corp.**  
5285 North Boulevard  
Raleigh, NC 27604  
Tel: (919) 876-0000

## OHIO

**Arrow Electronics, Inc.**  
7620 McEwen Road  
Centerville, OH 45459  
Tel: (513) 435-5563

**Arrow Electronics, Inc.**  
6238 Cochran Road  
Solon, OH 44139  
Tel: (216) 248-3990

**Hamilton Avnet Electronics, Inc.**  
4588 Emery Industrial Parkway  
Cleveland, OH 44128  
Tel: (216) 831-3500

**Hamilton Avnet Electronics**  
954 Senate Drive  
Dayton, OH 45459  
Tel: (513) 433-0610

**Hughes-Peters, Inc.**  
481 East Eleventh Avenue  
Columbus, OH 43211  
Tel: (614) 294-5351

**Kierulff Electronics, Inc.**  
23060 Miles Road  
Cleveland, OH 44128  
Tel: (216) 587-6558

**Schweber Electronics Corp.**  
23880 Commerce Park Road  
Beachwood, OH 44122  
Tel: (216) 464-2970

## OKLAHOMA

**Kierulff Electronics, Inc.**  
Metro Park 12318 East 60th  
Tulsa, OK 74145  
Tel: (918) 252-7537

## OREGON

**Hamilton Avnet Electronics**  
6024 S.W. Jean Road,  
Bldg. B-Suite J,  
Lake Oswego, OR 97034  
Tel: (503) 635-8157

**Wyle Distribution Group**  
5289 N.E. Ezram Young Parkway  
Hillsboro, OR 97123  
Tel: (503) 640-6000

## PENNSYLVANIA

**Arrow Electronics, Inc.**  
650 Seco Road  
Monroeville, PA 15146  
Tel: (412) 856-7000

**Herbach & Rademan, Inc.**  
401 East Erie Avenue  
Philadelphia, PA 19134  
Tel: (215) 426-1700

**Schweber Electronics Corp.**  
231 Gibraltar Road  
Horsham, PA 19044  
Tel: (215) 441-0600

## TEXAS

**Arrow Electronics, Inc.**  
13715 Gamma Road  
Dallas, TX 75240  
Tel: (214) 386-7500

**Arrow Electronics, Inc.**  
10899 Kinghurst Dr., Suite 100  
Houston, TX 77099  
Tel: (713) 530-4700

**Hamilton Avnet Electronics**  
2401 Rutland Drive  
Austin, TX 78758  
Tel: (512) 837-8911

**Hamilton Avnet Electronics**  
2111 West Walnut Hill Lane  
Irving, TX 75060  
Tel: (214) 659-4111

**Hamilton Avnet Electronics**  
8750 Westpark  
Houston, TX 77063  
Tel: (713) 975-3515

**Kierulff Electronics, Inc.**  
3007 Longhorn Blvd., Suite 105  
Austin, TX 78758  
Tel: (512) 835-2090

**Kierulff Electronics, Inc.**  
9610 Skillman Avenue  
Dallas, TX 75243  
Tel: (214) 343-2400

**Kierulff Electronics, Inc.**  
10415 Landsbury Drive, Suite 210  
Houston, TX 77042  
Tel: (713) 530-7030

**Schweber Electronics Corp.**  
4202 Beltway,  
Dallas, TX 75234  
Tel: (214) 661-5010

**Schweber Electronics Corp.**  
10625 Richmond Ste. 100  
Houston, TX 77042  
Tel: (713) 784-3600

**Sterling Electronics, Inc.**  
2335A Kramer Lane, Suite A  
Austin, TX 78758  
Tel: (512) 836-1341

**Sterling Electronics, Inc.**  
11090 Stemmons Freeway  
Stemmons at Southwell  
Dallas, TX 75229  
Tel: (214) 243-1600

**Sterling Electronics, Inc.**  
4201 Southwest Freeway  
Houston, TX 77027  
Tel: (713) 627-9000

## UTAH

**Hamilton Avnet Electronics**  
1585 West 2100 South  
Salt Lake City, UT 84119  
Tel: (801) 972-2800

**Kierulff Electronics, Inc.**  
2121 S. 3600 West Street  
Salt Lake City, UT 84119  
Tel: (801) 973-6913

**Wyle Distribution Group**  
1959 South 4130 West Unit B  
Salt Lake City, UT 84104  
Tel: (801) 974-9953

## WASHINGTON

**Arrow Electronics, Inc.**  
14320 N.E. 21st Street  
Bellevue, WA 98005  
Tel: (206) 643-4800

**Hamilton Avnet Electronics**  
14212 N.E. 21st Street  
Bellevue, WA 98005  
Tel: (206) 453-5874

**Kierulff Electronics, Inc.**  
1005 Andover Park E.  
Tukwila, WA 98188  
Tel: (206) 575-4420

**Priebe Electronics**  
2211 Fifth Avenue  
Seattle, WA 98121  
Tel: (206) 682-8242

**Wyle Distribution Group**  
1750 132nd Avenue, N.E.  
Bellevue, WA 98005  
Tel: (206) 453-8300

## WISCONSIN

**Arrow Electronics, Inc.**  
430 West Rawson Avenue  
Oak Creek, WI 53154  
Tel: (414) 764-6600

**Hamilton Avnet Electronics**  
2975 South Moorland Road  
New Berlin, WI 53151  
Tel: (414) 784-4510

**Kierulff Electronics, Inc.**  
2236G West Bluemond Road  
Waukesha, WI 53186  
Tel: (414) 784-8160

**Taylor Electric Company**  
1000 W. Donges Bay Road  
Mequon, WI 53092  
Tel: (414) 241-4321

## Canada Alberta

**Hamilton Avnet Elec.**  
2816 21st St. N.E., Calgary  
Alberta, T2E 6Z2  
Tel: (403) 230-3586

## RCA Authorized Distributors U.S. and Canada (Cont'd)

**Canada** L. A. Varah, Ltd.  
6420 6A Street SE,  
Calgary, Alberta T2H ZB7  
Tel: (403) 255-9550

**British Columbia**  
L. A. Varah, Ltd.  
2077 Alberta Street,  
Vancouver, B.C. V5Y 1C4  
Tel: (604) 873-3211

R.A.E. Industrial Electronics,  
Ltd.  
3455 Gardner Court, Burnaby,  
B.C. V5G 4J7  
Tel: (604) 291-8866

**Manitoba**  
L. A. Varah, Ltd.  
#12 1832 King Edward Street  
Winnipeg, Manitoba R2R 0N1  
Tel: (204) 633-6190

**Ontario**  
Cesco Electronics Ltd.  
24 Martin Ross Road  
Downsview, Ontario M3J 2K9  
Tel: (416) 661-0220

Electro Sonic, Inc.  
1100 Gordon Baker Road  
Willowdale, Ontario M2H 3B3  
Tel: (416) 494-1666

Hamilton Avnet (Canada) Ltd.  
6845 Rexwood Drive  
Units 3,4,5  
Mississauga, Ontario L4V 1M5  
Tel: (416) 677-7432

Hamilton Avnet (Canada) Ltd.  
210 Colonnade Street  
Nepean, Ontario K2E 7L5  
Tel: (613) 226-1700

L. A. Varah, Ltd.  
505 Kenara Avenue, Hamilton,  
Ontario L8E 1J8  
Tel: (416) 561-9311

**Quebec**  
Cesco Electronics, Ltd.  
4050 Jean Talon Street, West  
Montreal, Quebec H4P 1W1  
Tel: (514) 735-5511

Hamilton Avnet (Canada) Ltd.  
2670 Sabourin Street, St.  
Laurent, Quebec H4S 1M2  
Tel: (514) 331-6443

## Europe, Middle East, and Africa

**Austria** Bacher Elektronische Gerate  
GmbH  
Rotenmuhlgasse 26,  
A-1120 Vienna  
Tel: 0222/8356460

**Belgium** Inelco Belgium S.A.  
Avenue des Croix de Guerre 94  
1120 Bruxelles  
Tel: 02/216.01.60

**Denmark** Tage Olsen A/S  
P.O. Box 225  
DK - 2750 Ballerup  
Tel: 02/65 81 11

**Egypt** Sakrco Enterprises  
P.O. Box 1133,  
37 Kasr El Nil Street, Apt. 5  
Cairo  
Tel: 744440

**Ethiopia** General Trading Agency  
P.O. Box 1684  
Addis Ababa  
Tel: 132718 137275

**Finland** Telercas OY  
P.O. Box 33  
SF - 04201 Kerava  
Tel: 0/248.055

**France** Almex S.A.  
48, rue de l'Aubepine,  
F - 92160 - Antony  
Tel: (1) 666 21 12

Radio Equipments  
Antares S.A.  
9, rue Ernest Cognacq,  
F - 92301 - Levallois Perret  
Tel: (1) 758 11 11

Tekelec Airtronic S.A.  
Cite des Bruyeres,  
Rue Carle Vernet,  
F - 92310 - Sevres  
Tel: (1) 534.75.35

**Germany** Alfred Neye Enatechnik GmbH  
Schillerstrasse 14,  
2085 Quickborn  
West Germany  
Tel: 04106/6121

ECS Hillmar Frehsdorf GmbH  
Electronic Components Service  
Carl-Zeiss Strasse 3  
2085 Quickborn  
West Germany  
Tel: 04106/71058-59

Beck GmbH & Co.  
Elektronik Bauelemente KG  
Eltersdorfer Strasse 7,  
8500 Nurnberg 15  
West Germany  
Tel: 0911/34961-66

Elkose GmbH  
Bahnhofstrasse 44,  
7141 Moglingen  
West Germany  
Tel: 07141/4871

Sasco GmbH  
Hermann-Oberth-Strasse 16  
8011 Putzbrunn bei Munchen  
West Germany  
Tel: 089/46111

Spoerle Electronic KG  
Max-Planck Strasse 1-3,  
6072 Dreieich bei Frankfurt  
West Germany  
Tel: 06103/3041

**Greece** Semicon Co.  
104 Aeolou Str.  
TT.131 Athens  
Tel: 3253626

**Holland** Vekano BV  
Postbus 6115,  
N - 5600 HC Eindhoven  
Tel: (40) 81 09 75

**Hungary** Hungagent  
P.O. Box 542  
H-1374 Budapest  
Tel: 01/669-385

**Iceland** Georg Amundason  
P.O. Box 698, Reykjavik  
Tel: 81180

**Israel** Aviv Electronics  
Kehilat Venezia Street 12  
69010 Tel-Aviv  
Tel: 03-494450

**Italy** DEDO Elettronica SpA  
Strada Statale 16 Km 403-550  
64019 Tortoreto Lido (Te)  
Tel: 0861/78.67.46-48

Eledra 3S SpA  
Viale Elvezia 18,  
I - 20154, Milano  
Tel: (02) 349751

IDAC Elettronica SpA  
Via Verona 8,  
I - 35010 Busa di Vigonza  
Tel: (049) 72.56.99

LASI Elettronica SpA  
Viale Lombardia 6,  
I - 20092 Cinisello  
Balsamo (MI)  
Tel: (02) 61.20.441-5

Silverstar Ltd.  
Via dei Gracchi 20,  
I - 20146 Milano  
Tel: (02) 49.96

**Kuwait** Morad Yousuf Behbehani  
P.O. Box 146  
Kuwait

**Morocco** Societe d'Equipeement Mecanique  
et Electrique s.a. (S.E.M.E.)  
rue Ibn Batouta 29  
Casablanca  
Tel: (212) 22.08.65

**Norway** National Elektro A/S  
Ulvenveien 75, P.O. Box 53  
Okern, Oslo 5  
Tel: (472) 64 49 70

**Portugal** Telectra Sarl  
Rua Rodrigo da Fonseca, 103  
Lisbon I  
Tel: 68.60.72-75

**South Africa** Allied Electronic  
Components (PTY) Ltd.  
P.O. Box 6387  
Dunswart 1508  
Tel: (011) 528-661

**Spain** Kontron S.A.  
Salvatierra 4,  
Madrid 34  
Tel: 1/729.11.55

## RCA Authorized Distributors Europe, Middle East, and Africa(Cont'd)

<b>Spain</b>	<b>Novoelectric</b> Villaruel, 40, Barcelona 11 Tel: 254.18.07-08	<b>U.K.</b>	<b>ACCESS Electronic Components Ltd.</b> Austin House, Bridge Street Hitchin, Hertfordshire SG5 2DE Tel: Hitchin (0462) 31 221 <b>Gothic Crellon Electronics Ltd.</b> 380 Bath Road, Slough, Berks, SL1 6JE Tel: Burnham (06286) 4434	<b>STC Electronic Services</b> Edinburgh Way, Harlow Essex, CM20 2DF Tel: Harlow (0279) 26777 <b>VSI Electronics (U.K.) Ltd.</b> Roydonbury Industrial Park Horsecroft Road, Harlow Essex CM19 5 BY Tel: Harlow (0279) 29666
<b>Sweden</b>	<b>Ferner Electronics AB</b> Snormakarvagen 35, P.O. Box 125, S-161 26 Bromma Stockholm Tel: 08/80 25 40		<b>Jermyn Distribution</b> Vestry Industrial Estate Sevenoaks, Kent Tel: Sevenoaks (0732) 450144	<b>Yugoslavia</b>
<b>Switzerland</b>	<b>Baerlocher AG</b> Forrlibuckstrasse 110 8005 Zurich Tel: (01) 42.99.00		<b>Macro Marketing Ltd.</b> Burnham Lane, Slough, Berkshire SL1 6LN Tel: Burnham (06286) 4422	<b>Zambia</b>
<b>Turkey</b>	<b>Teknim Company Ltd.</b> Riza Sah Pehlevi Caddesi 7 Kavaklidere Ankara Tel: 27.58.00			<b>Zimbabwe</b>
				<b>BAK Electrical Holdings (Pvt) Ltd.</b> P.O. Box 2780 Salisbury

## Asia Pacific

<b>Australia</b>	<b>AWA Microelectronics</b> 348 Victoria Road Rydalmere N.S.W. 2116 <b>Amtron Tyree Pty. Ltd.</b> 176 Botany Street, Waterloo, N.S.W. 2017	<b>Indonesia</b>	<b>NVPD Soedarpo Corp.</b> Samudera Indonesia Building JL Letten, Jen. S Parman No. 35 Slipi Jakarta Barat	<b>Semitronics Philippines</b> 216 Ortego Street San Juan 3134, Metro Manila
<b>Bangladesh</b>	<b>Electronic Engineers &amp; Consultants Ltd.</b> 103 Elephant Road, 1st Floor Dacca 5	<b>Japan</b>	<b>Okura &amp; Company Ltd.</b> 3-6 Ginza, Nichome, Chuo-Ku Tokyo 104	<b>Singapore</b>
<b>Hong Kong</b>	<b>Gibb Livingston &amp; Co., Ltd.</b> 77 Leighton Road Leighton Centre P.O. Box 55 <b>Hong Kong Electronic Components Co.</b> Flat A Yun Kai Bldg. 1/ Fl 466-472 Nathan Road Kowloon	<b>Korea</b>	<b>Panwest Company, Ltd.</b> C.P.O. Box 3358 Room 603, Sam Duk Building 131 Da-Dong, Chung-Ku Seoul, Republic of South Korea	<b>Sri Lanka</b>
<b>India</b>	<b>Photophone Ltd.</b> 179-5 Second Cross Road Lower Palace Orchards Bangalore 560 003	<b>Nepal</b>	<b>Continental Commercial Distributors</b> Durbar Marg. Kathmandu	<b>Taiwan</b>
		<b>New Zealand</b>	<b>AWA NZ Ltd.</b> N.Z. P.O. Box 50-248 Porirua	<b>Delta Engineering Ltd.</b> No. 42 Hsu Chang Street 8th Floor, Taipei <b>Multitech International Corp.</b> No. 977 Min Shen East Road Taipei
		<b>Philippines</b>	<b>Philippine Electronics Inc.</b> P.O. Box 498 3rd Floor, Rose Industrial Bldg., 11 Pioneer St. Pasig, Metro Manila	<b>Thailand</b>
				<b>Anglo Thai Engineering Ltd.</b> 2160 Ramkambaeng Road Highway Hua Mark, Bangkok <b>Better Pro Co. Ltd.</b> 71 Chakkawat Road Wat Tuk, Bangkok

## Latin America

<b>Argentina</b>	<b>Eneka S.A.I.C.F.I.</b> Tucuman 299, 1049 Buenos Aires Tel: 31-3363 <b>Radiocom S.A.</b> Conesa 1003, 1426 Buenos Aires Tel: 551-2780 <b>Tecnos S.R.L.</b> Independencia 1861 1225 Buenos Aires Tel: 37-0239	<b>Panamericana Comercial Importadora Ltda.</b> Rua Aurora, 263, 01209, Sao Paulo, SP Tel: (011) 222-3211	<b>Colombia</b>	<b>Miguel Antonio Pena Pena Y Cia. S. En C.</b> Carrera 12 #1906 Bogota <b>Electronica Moderna</b> Carrera 9A, NRO 19-52 Apartado Aereo 5361 Bogota, D.E.I
<b>Brazil</b>	<b>Comercial Bezerra Ltda.</b> Rua Costa Azevedo, 139, CEP-69.000 Manaus/AM Tel: (092) 232-5363	<b>Chile</b>	<b>Raylex Ltda.</b> Av Providencia 1244, Depto. D, 3er Piso Casilla 13373, Santiago Tel: 749835 <b>Industria de Radio y Television S.A. (IRT)</b> Vic. MacKenna 3333 Casilla 170-D, Santiago Tel: 561667	<b>Costa Rica</b>
				<b>J. G. Valdeperas, S.A.</b> Calle 1, Avenidas 1-3, Apartado Postal 3923 San Jose Tel: 32-36-14
				<b>Dominican Republic</b>
				<b>Humberto Garcia, C. por A.</b> El Conde 366 Apartado de Correos 771 Santo Domingo Tel: 682-3645

## RCA Authorized Distributors Latin America (Cont'd)

<b>Ecuador</b>	<b>Elecom, S.A.</b> Padre Solano 202-OF. 8, P.O. Box 9611, Guayaquil	<b>Mexico</b>	<b>Electronica Remberg, S.A.</b> de C.V. Republica del Salvador No. 30-102, Mexico City 1, D.F. Tel: 510-47-49	<b>Surinam</b>	<b>Kirpalani's Ltd.</b> 17-27 Maagdenstreet, P.O. Box 251, Paramaribo Tel: 71-400
<b>El Salvador</b>	<b>Radio Electrica, S.A.</b> 4A Avenida Sur Nb. 228 San Salvador Tel: 21-5609 <b>Radio Parts, S.A.</b> 2A C. O. No. 319 Postal la Dalia, P.O. Box 1262 San Salvador Tel: 21-3019		<b>Mexicana de Bulbos, S.A.</b> Michoacan No. 30 Mexico 11, D.F. Tel: 564-92-33 <b>Partes Electronicas, S.A.</b> Republica Del Salvador 30-501 Mexico City Tel: (905) 585-3640		<b>Surinam Electronics</b> Keizerstreet 206 P.O. Box 412 Paramaribo Tel: 76-555
<b>Guatemala</b>	<b>Electronics Guatemalteca</b> 13 Calle 5-59, Zona 1 P.O. Box 514 Guatemala City Tel: 25-649 <b>Tele-Equipos, S.A.</b> 10A Calle 5-40, Zona 1 Apartado Postal 1798 Guatemala City Tel: 29-805		<b>Raytel, S.A.</b> Sullivan 47 Y 49 Mexico 4, D.F. Tel: 566-67-86 <b>El Louvre, S.A.</b> P.O. Box 138, Curacao Tel: 54004	<b>Trinidad</b>	<b>Kirpalani's Limited</b> Kirpalani's Komplex Churchill Roosevelt Highway San Juan, Port-of-Spain Tel: 638-2224/9
		<b>Netherland</b>		<b>Uruguay</b>	<b>American Products S.A.</b> (APSA) Casilla de Correo 1438 Canelones 1133 Montevideo Tel: 594210
		<b>Antilles</b>			<b>P. Benavides, P., S.R.L.</b> Residencias Camarat, Local 7 La Candelaria, Caracas MAIL ADDRESS: Apartado Posta 20.249 San Martin, Caracas Tel: (58-2) 571-21-46
<b>Haiti</b>	<b>Societe Haitienne</b> <b>D'Automobiles, S.A.</b> P.O. Box 428, Port-Au-Prince Tel: 2-2347	<b>Nicaragua</b>	<b>Comercial F. A. Mendieta, S.A.</b> Apartado Postal No. 1956 C.S.T. 5c A1 Sur 2c 1/2 Abajo Managua	<b>Venezuela</b>	<b>Da Costa and Musson Ltda.</b> Carlisle House Hincks Street P.O. Box 103 Bridgetown, Barbados Tel: 608-50
<b>Honduras</b>	<b>Francisco J. Yones</b> 3A Avenida S.O. 5 San Pedro Sula, Honduras, Central America Tel: 52-00-10	<b>Panama</b>	<b>Tropelco, S.A.</b> Via Espana 20-18, Panama 7 Rep. de Panama	<b>West Indies</b>	
		<b>Paraguay</b>	<b>Compania Comercial Del</b> <b>Paraguay, S.A.</b> Casilla de Correo 344 Chile 877, Asuncion		
		<b>Peru</b>	<b>Arven S.A.</b> PSJ Adan Mejia 103, OF. 33 Lima 11 Tel: 716229		

## RCA Manufacturers' Representatives - U.S.

### Alabama

**CSR Electronics**  
7272-E2 Arcadia Ci. N.W.  
Huntsville, AL 35801  
Tel: (205) 533-2444

### Arizona

**Thom Luke Sales, Inc.**  
2940 North 67th Place  
Suite H  
Scottsdale, AZ 85251  
Tel: (602) 941-1901

### California

**CK Associates**  
8333 Clairemont Mesa Blvd.  
Suite 105  
San Diego, CA 92111  
Tel: (714) 279-0420

### Connecticut

**New England Technical Sales  
(NETS)**  
240 Pomeroy Avenue  
Meriden, CT 06450  
Tel: (203) 237-8827

### Florida

**G.F. Bohman Assoc., Inc.**  
130 N. Park Avenue  
Apopka, FL 32703  
Tel: (305) 886-1882

**G.F. Bohman Assoc., Inc.**  
2020 W. McNab Road  
Ft. Lauderdale, FL 33309  
Tel: (305) 979-0008

### Georgia

**CSR Electronics**  
1530 Dunwoody Village Pkwy.  
Suite 110  
Atlanta, GA 30338  
Tel: (404) 396-3720

### Kansas

**Electri-Rep**  
7070 W. 107th Street  
Suite 160  
Overland Park, KS 66212  
Tel: (913) 649-2168

### Massachusetts

**New England Technical Sales  
(NETS)**  
135 Cambridge Street  
Burlington, MA 01803  
Tel: (617) 272-0434

### Minnesota

**Comprehensive Technical Sales**  
8053 Bloomington Freeway  
Minneapolis, MN 55420  
Tel: (612) 888-7011

### New Jersey

**Astrorep, Inc.**  
717 Convery Blvd.  
Perth Amboy, NJ 08861  
Tel: (201) 826-8050

### New York

**Astrorep, Inc.**  
103 Cooper Street  
Babylon, L.I., NY 11702  
Tel: (516) 422-2500

### North Carolina

**CSR Electronics**  
4208 Six Forks Road  
Suite 305  
Raleigh, NC 27609  
Tel: (919) 787-2137

### Ohio

**Lyons Corporation**  
4812 Frederick Road  
Suite 101  
Dayton, OH 45414  
Tel: (513) 278-0714

### Lyons Corporation

4615 W. Streetsboro Road  
Richfield, OH 44286  
Tel: (216) 659-9224

### South Carolina

**CSR Electronics**  
1506 Winding Way  
So. Carolina  
Taylors, SC 29687  
Tel: (803) 292-2388

### Texas

**Southern States Marketing**  
400 E. Anderson Lane  
Suite 218-6  
Austin, TX 78752  
Tel: (512) 452-9459

**Southern States Marketing**  
9730 Townpark Drive #105  
Houston, TX 77036  
Tel: (713) 988-0991

**Southern States Marketing**  
1142 Rockingham  
Suite 106  
Richardson, TX 75080  
Tel: (214) 238-7500

### Utah

**Simpson Assocs.**  
7324 So. 1300 E.  
Suite 350  
Midvale, UT 84047  
Tel: (801) 566-3691

### Washington

**Vantage Corp.**  
300 120th Avenue N.E.  
Bldg. 7, Suite 207  
Bellevue, WA 98005  
Tel: (206) 455-3460

**RCA** Solid State

# DATABOOK

